



October 20, 2004  
File: 012187-100

Brian Chow, M. Eng., P.Eng.  
Senior Structures & Roads Engineer  
Ministry of Forests  
Resource Tenures and Engineering Branch  
PO Box 9510 Stn Prov Govt  
727 Fisgard Street  
Victoria, B.C.  
V8W 9C2

**Re: DESIGN OF SINGLE-LANE SHEAR-CONNECTED SLAB BRIDGES REV 1**

Dear Mr. Chow:

Associated Engineering is pleased to submit a revised technical memorandum summarizing the proposed design methodology for single-lane shear connected slab bridges. In addition, we have also attached the research report, "Simplified Analysis of Single-Lane Shear Connected Concrete Plank Bridges" and "Simplified Analysis of Skew Single-Lane Shear-Connected Slab Bridges", both prepared by Dr. Baidar Bakht, P.Eng. This issue is one of several we are addressing to permit the adoption of S6-00 for the design of forestry bridges in B.C.

If you have any further questions, please feel free to contact me at your convenience.

Yours truly,



Julien Henley, M.A.Sc., P.Eng.  
Structural Engineer

JH/mceb

Reviewed by:



D. I. Harvey, P.Eng., Struct.Eng.  
Senior Structural Engineer

Associated  
Engineering  
(B.C.) Ltd.

Suite 300  
4940 Canada Way  
Burnaby, B.C.  
Canada  
V5G 4M5

Tel. 604.293.1411  
Fax 604.291.6163

[www.ae.ca](http://www.ae.ca)

MEMO

ASSOCIATED  
ENGINEERING



SEND TO

Brian Chow, P.Eng.

Ministry of Forests

FROM

ASSOCIATED ENGINEERING

LOCATION

Burnaby

NAME

Julien Henley, P.Eng.

RE:

PROJECT NO.  
012187

FILE

DATE

October 20, 2004

SUBJECT

LOAD DISTRIBUTION IN SINGLE LANE SHEAR CONNECTED SLAB BRIDGES (REV 1)

As previously discussed in the "Evaluation of CAN/CSA-S6-00 (2000 Canadian Highway bridge Design Code)", Section 5 does not include live load distribution factors for single lane multi-spine bridges. Associated Engineering therefore retained Dr. Baidar Bahkt to derive the required live load distribution factors. The following summarises the result of the work completed (A complete copy of the report prepared by Dr. Bakht is attached to this memorandum).

## 1. CHARACTERISATION PARAMETER

All slab bridges can be characterised by the following parameter:

$$\beta = \pi \left( \frac{2b}{L} \right) \left( \frac{0.3833}{K} \right)^{0.5}$$

Where:  $2b$  = overall bridge/deck width  
 $L$  = span  
 $K$  = stiffness parameter defined as

$$K = \frac{1}{3} - \frac{0.21t}{S}$$

Where:  $t$  = slab thickness  
 $S$  = slab width

## 2. DISTRIBUTION OF LONGITUDINAL MOMENTS

As outlined in CAN/CSA-S6-00 Clause 5.7.1.2, the longitudinal moment can be calculated as follows:

$$M_g = F_m \times M_{gave}$$

October 20, 2004

MEMO

- 2 -

Where:  $M_g$  = Average moment per slab assuming the total moment is shared equally by all slabs

For shear connected slab bridges,  $F_m$  is defined as follows:

$$F_m = \frac{S \times N}{F + \mu \times C_f}$$

Where:  $\mu = \frac{2b - 4.26}{1.24}$

$F$  and  $C_f$  are defined in Table 1

**Table 1**  
**Definition of  $F$  and  $C_f$  for Calculation of Longitudinal Moments**

Axle Spacing (mm)	Load Distribution	$F$	$C_f$
1800	60:40	$3.73-0.26\beta$	$0.75-0.12\beta$
	50:50	$4.10-0.27\beta$	$0.75-0.12\beta$
1980	60:40	$3.85-0.27\beta$	$0.75-0.12\beta$
	50:50	$4.05-0.22\beta$	$0.75-0.12\beta$
2660	60:40	$4.65-0.45\beta$	$0.9-0.15\beta$
	50:50	$4.18-0.21\beta$	$0.9-0.15\beta$

### 3. DISTRIBUTION OF LONGITUDINAL SHEAR

As outlined in CAN/CSA-S6-00 Clause 5.7.1.5, the longitudinal shear can be calculated as follows:

$$V_g = F_v \times V_{gave}$$

Where:  $V_g$  = Average shear per slab assuming the total moment is shared equally by all slabs

For shear connected slab bridges,  $F_v$  is defined as follows:

October 20, 2004

MEMO

- 3 -

$$F_v = \frac{S \times N}{F + \mu \times C_f}$$

Where:  $\mu = \frac{2b - 4.26}{1.24} \leq 1.0$

$F$  and  $C_f$  are defined in Table 2

**Table 2**  
**Definition of  $F$  and  $C_f$  for Calculation of Longitudinal Shears**

Axle Spacing (mm)	Load Distribution	$F$	$C_f$
1800	60:40	$2.76-0.10\beta$	$0.30-0.04\beta$
	50:50	$3.16-0.10\beta$	$0.30-0.04\beta$
1980	60:40	$2.90-0.17\beta$	$0.28-0.04\beta$
	50:50	$3.22-0.10\beta$	$0.28-0.04\beta$
2660	60:40	$2.90-0.11\beta$	$0.40-0.05\beta$
	50:50	$3.38-0.11\beta$	$0.40-0.05\beta$

#### 4. TRANSVERSE SHEAR IN WELDED SHEAR CONNECTORS

The following method outlines the calculation of the transverse shear demand ( $V_{y\max}$ ) on the welded shear connector.

$$V_{y\max} = V \left( \frac{S_{sk}}{1.6} \right)$$

Where:  $S_{sk}$  = shear connector spacing

$V$  defined in Table 3

**Table 3**  
**Definition of V for the Calculation of Transverse Shear in Welded Shear Connector**

Axle Spacing (mm)	Load Distribution	V' (kN)
1800	60:40	$(P/306.8) \times (58-4\beta)$
	50:50	$(P/306.8) \times (54-4\beta)$
1980	60:40	$(P/409.2) \times (60-5\beta)$
	50:50	$(P/409.2) \times (58-5\beta)$
2660	60:40	$(P/613.8) \times (68-3\beta)$
	50:50	$(P/613.8) \times (64-4\beta)$

Note:

1. P is defined as the total weight of the tandem axle i.e. 250 kN for CL-625 truck or 0.4W for CL-W truck

## 5. SKEWED SLABS

Given that skewed geometry tends to magnify longitudinal shear in exterior slabs, and the initial methodology presented is applicable to right angle bridges only, Dr. Bakht completed a further study to investigate the effect of bridge skew. A copy of this report has been included with this Memorandum.

Based on this study, typical shear magnification factors for skew bridges ranged from 1.00-1.05 for skews less than 30° to 1.05-1.08 for skews between 30-45°. If the effect of skew were to be ignored, this would suggest that shears would be underestimated by a maximum of 8%. Since an un-safe error of 5% is considered acceptable in bridge design, we feel that the effect of bridge skew on shear-connected slab bridges could be ignored without resulting in an un-safe shear design.

## 6. DESIGN METHODOLOGY FOR SHEAR CONNECTED SLAB BRIDGES

Based on the above the following methodology can be adopted for the design of single lane welded or grouted shear connected slab bridges if the bridge conforms to the requirements of CAN/CSA-S6-00 Clauses 5.6.1 and 5.6.2 (see Section 6 of this memorandum):

- Longitudinal moments calculated in accordance with the methodology outlined in Section 2.

October 20, 2004

**MEMO**

- 5 -

- Longitudinal shear calculated in accordance with the methodology outlined in Section 3 (effect of bridge skew can be ignored).
- Torsional moment can be ignored.
- Shear connectors be spaced between 1.6 and 2.1 m
- Incorporate MoF standard shear connector designs based on design vehicle loading.
- Section design in accordance with relevant clauses in CAN/CSA-S6-00 Section 8 (Concrete Structures) including requirements for minimum transverse reinforcement where required.

# **SIMPLIFIED ANALYSIS OF SINGLE-LANE SHEAR-CONNECTED CONCRETE PLANK BRIDGES**

by

Baidar Bakht

Prepared for

The British Columbia Ministry of Forestry

Submitted through

Associated Engineering (B.C.) Ltd.

(Attention: Mr. Julien Henley, P.Eng.)

21 Whiteleaf Crescent

Scarborough ON M1V 3G1

[bbakht@rogers.com](mailto:bbakht@rogers.com)

Phone: (416) 292 4391

Fax: (416) 292 7374

Original report: March 2004

Slightly revised: May 2004

**TABLE OF CONTENTS**

	EXECUTIVE SUMMARY, 3
1.	INTRODUCTION, 5
2.	DEVELOPMENTAL BACKGROUND, 6
2.1	Characterizing parameter, 6
2.2	Range of characterizing parameter, 8
2.3	Design vehicles, 10
2.4	Effectiveness of characterizing parameters, 11
3.	SIMPLIFIED METHOD FOR LONGITUDINAL MOMENTS, 13
3.1	Details of plates and truck placement, 13
3.2	Confirmation of basic assumption, 15
3.3	Calculation of plank moments through plate analysis, 16
3.4	Calculation of $F$ , 18
3.5	Results, 19
3.6	Proposed method for longitudinal moments, 22
3.7	Example, 22
4.	SIMPLIFIED METHOD FOR LONGITUDINAL SHEARS, 24
4.1	Locating longitudinal section for maximum longitudinal shear intensity, 24
4.2	Results, 26
4.3	Proposed method for longitudinal moments, 27
4.4	Example, 27
5.	SIMPLIFIED METHOD FOR TRANSVERSE SHEARS, 28
5.1	Developmental analyses, 28
5.2	Proposed method, 31
5.3	Example, 32
6.	REFERENCES, 32



## EXECUTIVE SUMMARY

All three simplified methods of analysis for shear-connected concrete plank bridges, with a single lane, require the calculation of a characterizing parameter  $\mathbf{b}$ , which is obtained from the following equation.

$$[a] \quad \mathbf{b} = \mathbf{p} \left( \frac{2b}{L} \right) \left( \frac{0.3833}{K} \right)^{0.5}$$

In the above equation,  $K$  depends upon the plank thickness  $t$  and width  $S$ , and is obtained from:

$$[b] \quad K = \frac{1}{3} - \frac{0.21t}{S}$$

The three simplified methods are developed for six different design trucks (A1, A2, B1, B2, C1 and C2), some of which are used in the design of forestry bridges in British Columbia. The design trucks are illustrated in Fig. 7 of the report. The methods are summarised in the following.

### Method for longitudinal moments

The proposed method for obtaining longitudinal moments is the same as specified in Clause 5.7.1.3 of the CHBDC (2000), except the following. The value of the amplification factor  $F_m$  shall be obtained from the following equation.

$$[c] \quad F_m = \frac{SN}{F + mC_f}$$

where values of  $F$  and  $C_f$  are obtained from the expressions given in Table 5 of the report. For example,  $F$ , in meters, for Truck A1 =  $3.73 - 0.26 \mathbf{b}$ .  $m$  is given by the following equation, in which the bridge width,  $2b$ , is in metres.

$$[d] \quad m = \frac{2b - 4.26}{1.24}$$

If the value of  $m$  is greater than 1.0, it shall be assumed to be 1.0. The above method for Truck A2 can also be used for the CHBDC design loads.

### Method for longitudinal shears

The proposed method for obtaining longitudinal shears in single-lane shear-connected concrete plank bridges is the same as specified in Clause 5.7.1.5 of the CHBDC (2000), except the following.

The value of the amplification factor  $F_v$  shall be obtained from the following equation.

$$[e] \quad F_v = \frac{SN}{F + mC_f}$$

where values of  $F$  and  $C_f$  are obtained from the expressions given in Table 6, and  $m$  is given by Equation [d]. If the value of  $m$  is greater than 1.0, it shall be assumed to be 1.0. The above method for Truck A2 can also be used for the CHBDC design loads.

### Method for transverse shear

The maximum shear force  $V_{y \max}$  in shear keys, spaced at a centre-to-centre distance of  $S_{sk}$  in metres, shall be obtained from the following equation.

$$[f] \quad V_{y \max} = V \left( \frac{S_{sk}}{1.6} \right)$$

where the datum value of the transverse shear force for ( $S_{sk} = 1.6$  m),  $V$ , is obtained from the expressions given in Table 8 of the report for the design truck under consideration. In the case of continuous shear keys,  $S_{sk}$  shall be assumed to be 1.0 m, and the value of  $V_{y \max}$  thus obtained shall be for a 1.0 m length of the shear key.

The value of  $V$  in kN for the CL-W Design Truck of the CHBDC (2000) shall be obtained from the following equation, in which  $W$  is the total weight of the design truck in kN.

$$[g] \quad V = \left( \frac{0.2W}{306.8} \right) (54 - 4b)$$

## 1. INTRODUCTION

A large number of short span bridges on forestry roads in British Columbia are made of precast concrete planks that are joined together in the field by means of welded or grouted shear keys. All these bridges are single lane bridges. A typical shear-connected bridge with four concrete planks joined by welded shear keys is shown in Fig. 1.



Figure 1 A typical shear-connected concrete plank bridge in British Columbia

Neither of welded and grouted shear keys is capable of sustaining substantial bending moments. Accordingly, bridges under consideration can be idealized as articulated plates, a special case of orthotropic plates, in which the transverse flexural rigidity  $D_y$  is zero. The cross-section of an idealized articulated plate is shown in Fig. 2.

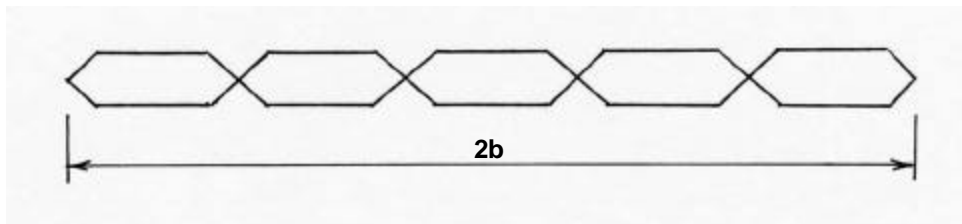

Figure 2 Cross-section of an articulated plate

Utilizing data from field tests on two shear-connected bridges on forestry roads of BC, Bakht and Mufti (2001) have shown that these bridges can be idealized as articulated plates but only after

the longitudinal torsional rigidity of the planks is assumed to be about half the actual torsional rigidity. The reduction in the torsional rigidity is made necessary because the planks are not fully restrained against rotation at their supports.

The Canadian Highway Bridge Design Code (CHBDC 2000) includes simplified methods of transverse load distribution analysis for different types of bridges. However, these methods were developed by assuming that the wheel loads on an axle are distributed equally, whereas wheel loads on design trucks used for bridges on BC forestry roads are distributed unevenly.

The CHBDC includes a simplified method for multispine bridges without intermediate cross-frame between the spines, i.e. boxes. Since  $D_y$  in multispine bridges is very small as compared to their longitudinal flexural rigidity, these bridges can also be idealized as articulated plates. The CHBDC simplified method for multispine bridges utilizes the characterizing parameter for articulated plates  $\mathbf{b}$ , defined later through Equation [1]. Longitudinal moments and shears in multispine bridges are obtained with the help of CHBDC Tables 5.7.1.3, and 5.7.1.5, respectively. Arguably, the CHBDC simplified method for multispine bridges could also be used for the shear-connected concrete plank bridges. However, the method for multispine bridges does not cover single lane bridges. The CHBDC, through Clause 5.7.1.8, also provides a simplified method for calculating transverse shear in shear-connected beam bridges. The method, however, is limited to bridge widths 7.5 m and higher. The British Columbia Ministry of Forests wanted to develop CHBDC-type simplified methods for its single-lane shear-connected bridges, generally having widths of 5.5 m or less. In particular, the task required the development of the following simplified methods for the Forestry design trucks.

- a. A method to determine maximum live load longitudinal moments in concrete planks by revising Clause 5.7.1.3 of the CHBDC.
- b. A method to determine maximum live load longitudinal shears in concrete planks by revising Clause 5.7.1.5 of the CHBDC.
- c. A method for determining maximum live load transverse shear in shear keys by revising Clause 5.7.1.8 of the CHBDC.

This report provides details of the development of the simplified methods described above.

## 2. DEVELOPMENTAL BACKGROUND

### 2.1 Characterizing parameter

As noted earlier, an orthotropic plate with negligible transverse flexural rigidity,  $D_y$ , is referred to as an articulated plate (e.g. Spindel 1961; Bakht and Jaeger 1985). The load distributing properties of a rectangular articulated plate, supported at two opposite edges, depend upon the characterizing parameter  $\mathbf{b}$ , which is defined by the following equation.

$$[1] \quad \mathbf{b} = \mathbf{p} \left( \frac{2b}{L} \right) \left( \frac{D_x}{D_{xy}} \right)^{0.5}$$

where

- $2b$  = width of bridge  
 $L$  = span of bridge  
 $D_x$  = longitudinal flexural rigidity of the plate per unit width  
 $D_{xy}$  = longitudinal torsional rigidity of the plate per unit width

For shear-connected concrete plank bridges, the two rigidities are calculated as follows.

$$[2] \quad D_x = \left( \frac{Et^3}{12} \right)$$

$$[3] \quad D_{xy} = 0.5GKt^3$$

where

- $E$  = modulus of elasticity of plank concrete  
 $G$  = shear modulus of plank concrete  
 $K$  = torsion coefficient

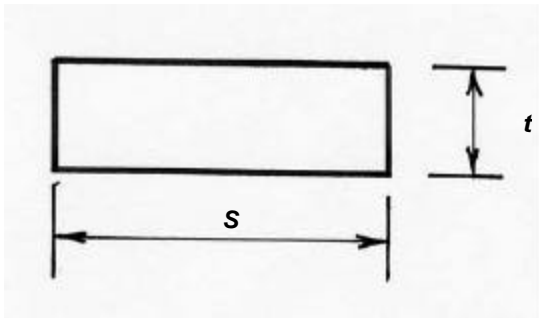

Figure 3 Cross-section of a concrete plank

When the width  $S$  of a plank is greater than 1.5 times its thickness  $t$  (Fig. 3), an approximate value of  $K$  is given by the following equation.

$$[4] \quad K = \frac{1}{3} - \frac{0.21t}{S}$$

For the exercise at hand,  $G$  can be assumed to be equal to  $E/2.3$ . Using this relationship between  $E$  and  $G$ , Equation [1] can be rewritten as follows.

$$[5] \quad \mathbf{b} = \mathbf{p} \left( \frac{2b}{L} \right) \left( \frac{0.3833}{K} \right)^{0.5}$$

## 2.2 Range of characterizing parameter

For finding the full range of  $b$  for single-lane bridges under consideration, the following assumptions are made, it being noted that Associated Engineering (B.C.) Ltd. has confirmed these assumptions to be realistic.

- The span length  $L$  varies from 6 to 14 m.
- The width  $2b$  varies from 4.26 to 5.50 m (Fig. 4).
- The number of planks in bridges varies between 4 and 7 thus giving the maximum and minimum plank widths  $S$  of 0.61 and 1.38 m, respectively (Fig. 4).
- The thickness of concrete plank varies between 0.35 and 0.60 m (Fig. 5).

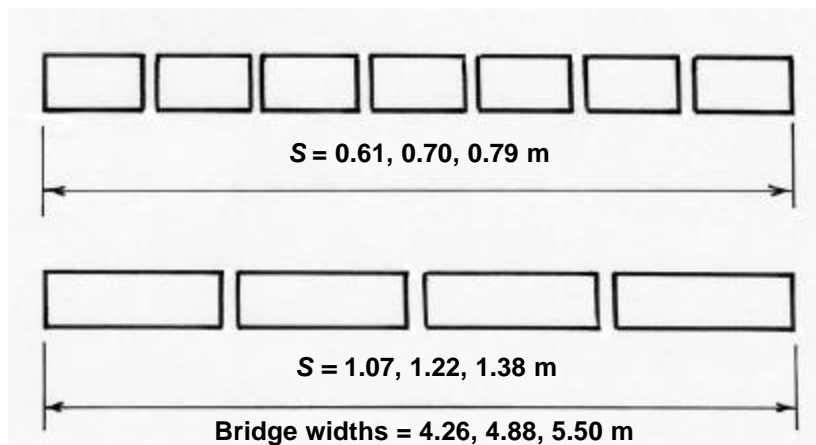

Figure 4 Widths of shear-connected bridges considered in study

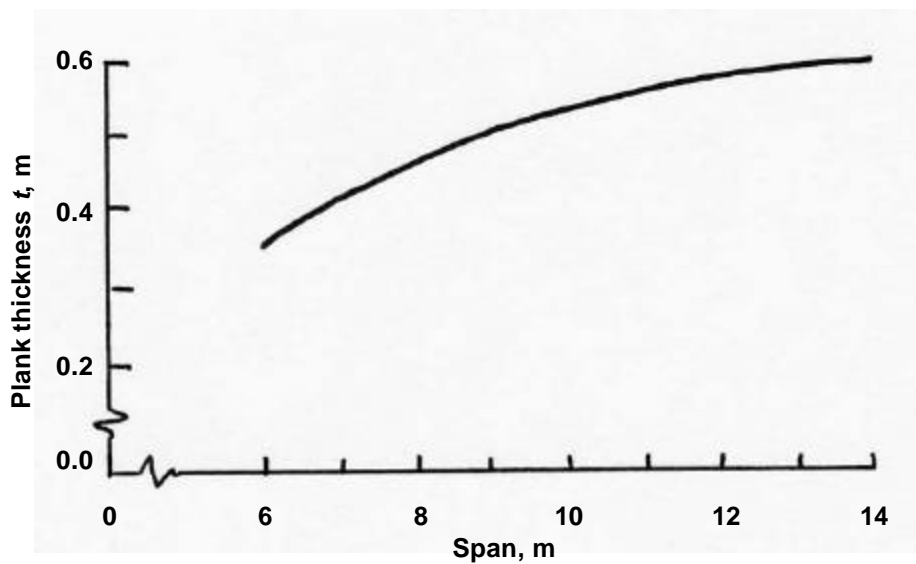

Figure 5 Plank thickness plotted against span length

Using the above assumptions, the value of  $b$  for the widest bridge with the smallest span was found to be 3.36, and that for the narrowest bridge with the largest span to be 1.64. Calculated values of  $b$  based on the above assumptions are plotted against the span length in Fig. 5. As also shown in this figure, the upper value of  $b$  was increased for the study at hand to cover cases not covered by the above assumptions.

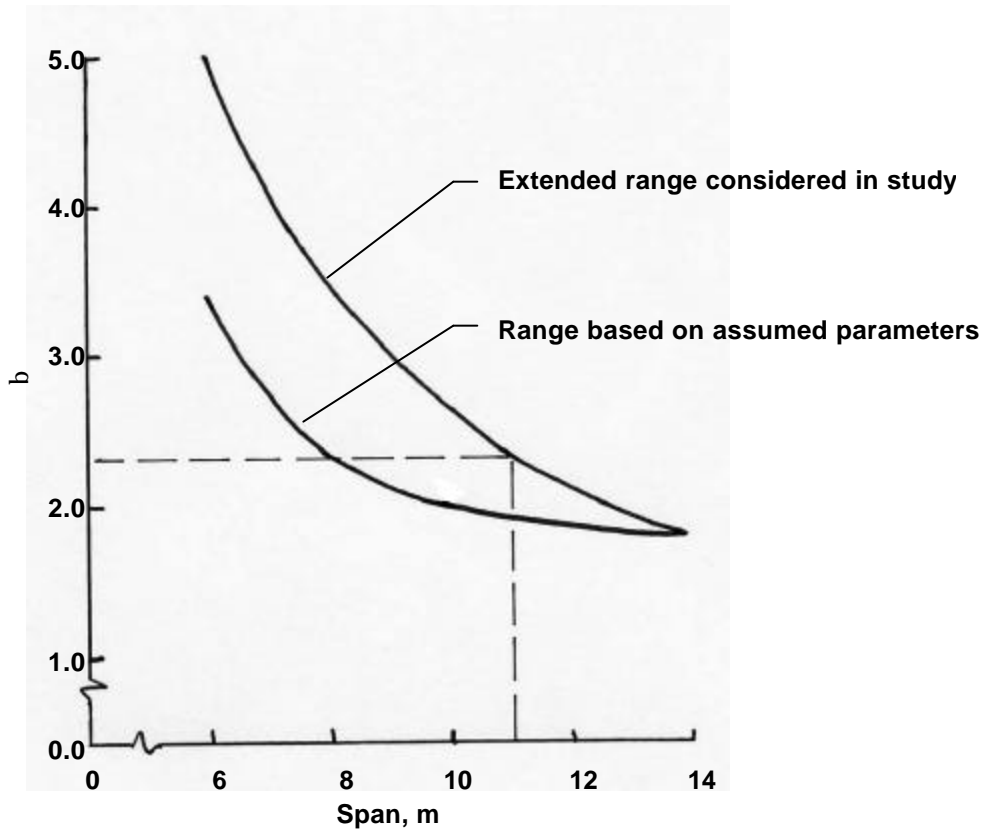

Figure 6  $b$  plotted against span length

Table 1 Parameters of idealized bridges

Designation	Span, m	$D_x$ , kN·mm <sup>2</sup>	$D_x$ , kN·mm <sup>2</sup>	$b$
6N	6.0	125,052	24,439	5.04
8N	8.0	283,897	64,242	3.52
10N	10.0	434,224	104,958	2.72
12N	12.0	540,146	150,006	2.11
14N	14.0	630,000	210,600	1.65
6W	6.0	125,052	40,838	5.04
8W	8.0	283,897	106,583	3.52
10W	10.0	434,224	175,303	2.72
12W	12.0	540,146	250,011	2.11
14W	14.0	630,000	351,540	1.65

Two sets of idealized articulated plates were considered: In one set, the plate width,  $2b$ , was taken as 4.26 m, and in the other 5.5 m. Values of  $D_x$  for the idealized bridges were calculated by selecting  $t$  from Fig. 5, and by assuming  $E$  to be 35,000 MPa. Values of  $D_{xy}$  for the various bridges were back calculated from the assumed values of  $b$ , which are listed in Table 1 along with the values of  $D_x$  and  $D_{xy}$ . In this table, each bridge is assigned a designation, the number being the span length in metres and the letter indicating whether the bridge is narrow in width (N) or wide (W).

### 2.3 Design vehicles

The three design trucks used for the design of forestry bridges in British Columbia are shown in Fig. 7. As can be seen in this figure, all three trucks have five axles, and each has a dual-axle tandem, which will mainly govern the design of bridges under consideration. Figure 7 also shows that the transverse distance between the longitudinal edge of the bridge and the centreline of the nearer line of wheels of all trucks is 600 mm. Since the widths of all three design trucks are different from each other, it is necessary to develop the simplified methods for each truck separately.

The BC Ministry of Forestry design guidelines require that the weights of wheels on an axle be assumed to be distributed in the 60:40 ratio. Associated Engineering (B.C.) Ltd., under whose direction this project is undertaken, required that the simplified methods be also developed for the 50:50 weight distribution. Thus it can be seen that effectively, the simplified methods are required to be developed for six different design trucks.

For the dual-axle tandems, the tire contact area at ground was assumed to be rectangular with dimensions in the longitudinal and transverse directions of the bridge being 250 and 600 mm.

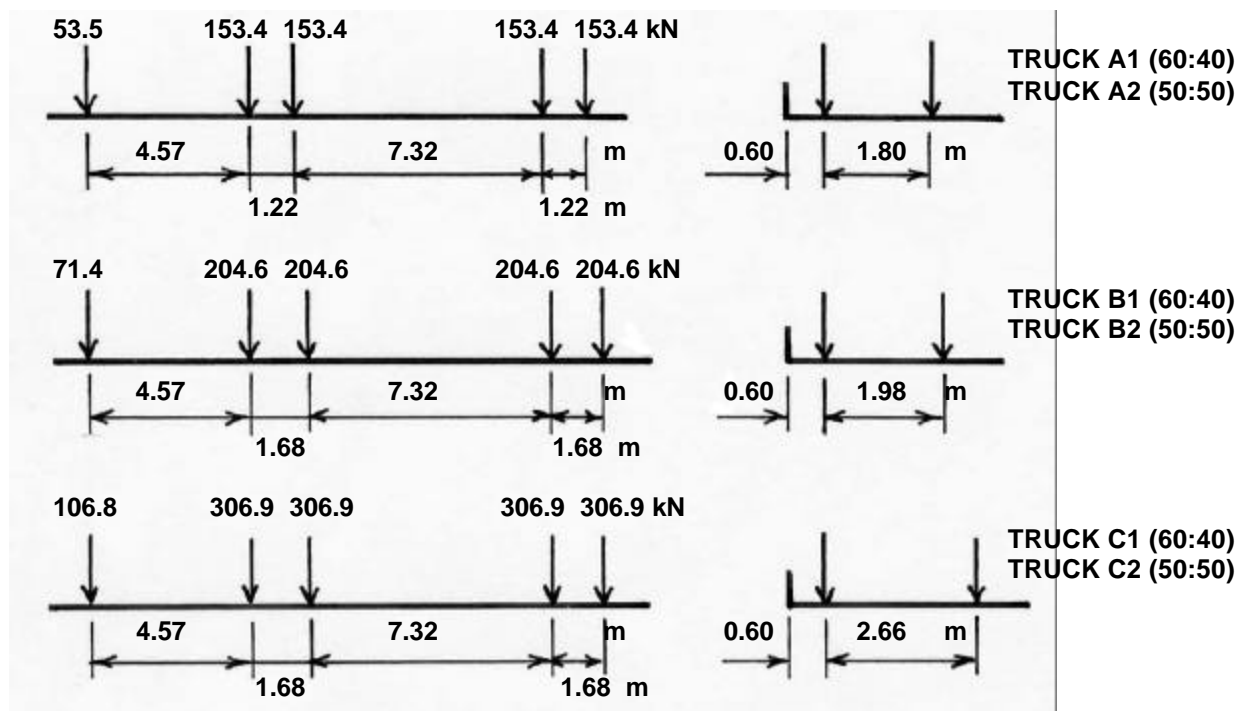

Figure 7 Details of design trucks



## 2.4 Effectiveness of characterizing parameters

In order to investigate the effectiveness of  $b$  in characterizing the load distribution properties of different bridges, two bridges with different spans but the same width (4.88 m) were selected. As shown in Fig. 8, one bridge had a span of 11 m, and the other a span of 8 m. Values of  $D_x$ , calculated by using the plank thickness from Fig. 5, were 498,615 and 283,897 kN·mm<sup>2</sup>, respectively. It was decided to fix the value of  $b$  for both the bridges at 2.34. Accordingly, values of  $D_{xy}$  for the two bridges were calculated to be 176,296 and 190,064 kN·mm<sup>2</sup>, respectively. As shown in Fig. 8, the two bridges were subjected to a dual-axle tandem of Truck A2 (Fig. 7), placed centrally in the longitudinal direction. The vehicle edge distance (VED) for loadings in both bridges was 0.60 m.

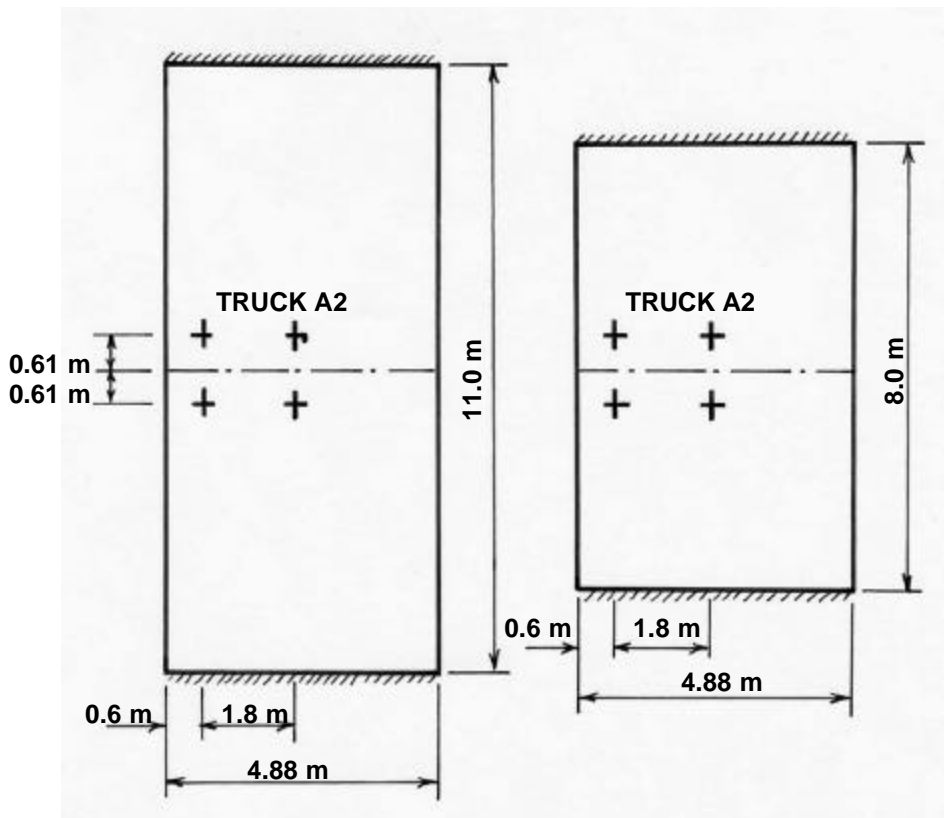

Figure 8 Two bridges with  $b = 2.34$

The two bridges of Fig. 8 were analyzed as articulated plates by the computer program PLATO (Bakht et al. 2002), which is based on the orthotropic plate theory of Cusens and Pama (1975). The co-ordinate system employed by PLATO is illustrated in Fig. 9, which also shows that responses due to rectangular patch loads can be calculated either on equally-spaced points on a transverse reference section or on individual reference points. The longitudinal direction of the bridge is denoted by  $x$ -axis, and the transverse by  $y$ -axis.

In each bridge of Fig. 8, longitudinal moment intensities were calculated at a transverse section containing the two wheel loads. For the 11-m and 8-m span bridges, the average intensities of longitudinal moment at the respective reference sections were calculated to be

153.71 and 106.56 kN·mm/mm, respectively. Moment intensities obtained by PLATO at nine equally-spaced reference points in the two bridges are listed in Table 2.

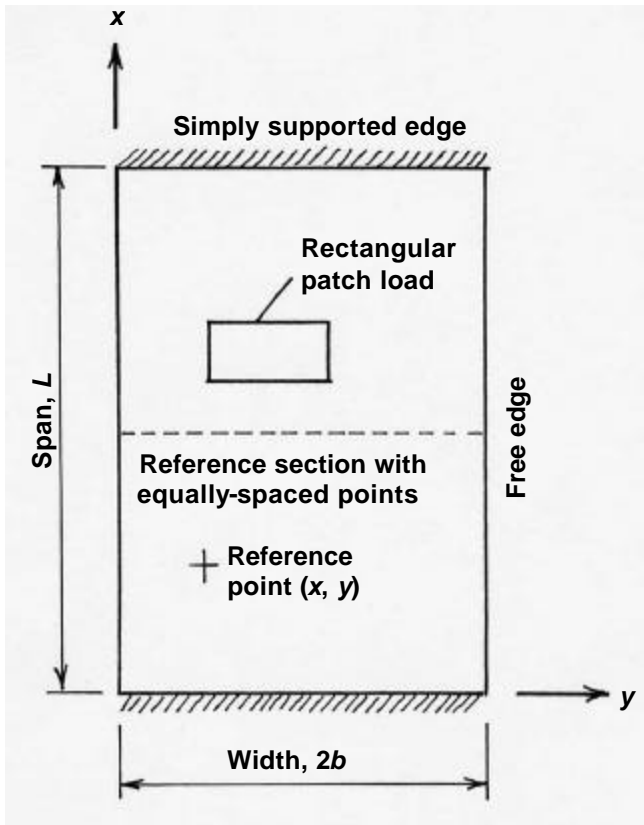

Figure 9 Co-ordinate system used by PLATO

Table 2 Longitudinal moment intensities in kN·mm/mm and distribution factors at the transverse reference section containing an axle (Fig. 8)

<b>y, m</b>	<b>0.00</b>	<b>0.61</b>	<b>1.22</b>	<b>1.83</b>	<b>2.44</b>	<b>3.05</b>	<b>3.66</b>	<b>4.27</b>	<b>4.88</b>
$M_x$ in bridge with $L=11$ m	209.6	204.0	183.4	173.6	167.0	136.1	107.1	92.9	88.5
DF in bridge with $L=11$ m	1.36	1.33	1.19	1.13	1.09	0.89	0.70	0.60	0.58
$M_x$ in bridge with $L=8$ m	143.4	139.7	126.2	119.4	114.4	94.0	74.8	65.3	62.3
DF in bridge with $L=8$ m	1.35	1.31	1.26	1.12	1.07	0.88	0.70	0.61	0.58

Distribution factor (DF), a non-dimensional measure of load distribution characteristics of a bridge, is obtained by dividing the actual longitudinal moment intensity with the average intensity. Thus obtained values of DF for longitudinal moment intensities for the two bridges are also listed in Table 2 and are compared in Fig. 10. The observation that the two curves of DF are

very close to each other confirms that  $b$  is very effective in characterizing the transverse load distribution properties of a bridge.

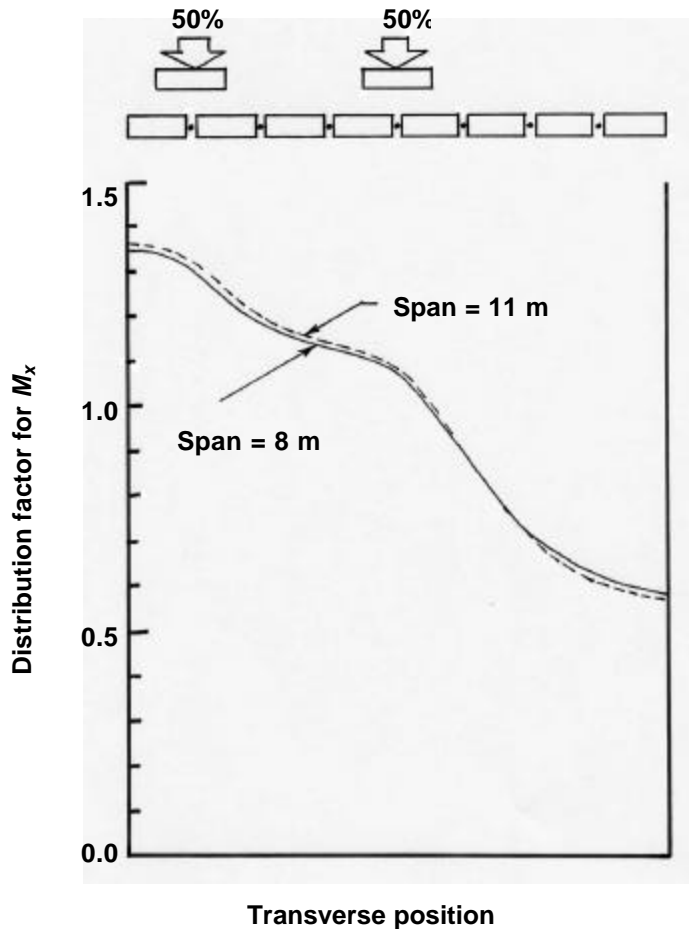

Figure 10 Distribution factors for longitudinal moment intensity in two plates having the same value of  $b$ .

### 3. SIMPLIFIED METHOD FOR LONGITUDINAL MOMENTS

#### 3.1 Details of plates and truck placement

Maximum longitudinal moment intensities under a single vehicle are induced in a bridge when the vehicle is placed as eccentrically as possible. It can be seen in Fig. 1 that in bridges under consideration, the timber guardrails are attached outside the deck, so that a longitudinal free edge of the bridge can be regarded as the edge of the design lane. Accordingly, trucks were so placed that the VED was 0.6 m in each case. The transverse positions of the three design trucks with respect to the nearer longitudinal free edge of the bridge are shown in Fig. 11.

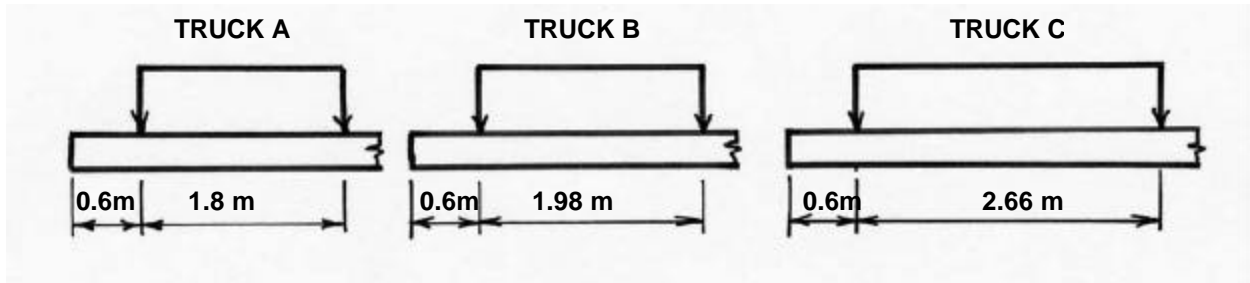

Figure 11 Transverse positions of design trucks

Details of the placement of the three design trucks on bridges with a span of 6 m are shown in Fig. 12. This figure shows the truck placements for obtaining maximum intensities of both longitudinal moments and shears. Analyses for the latter are discussed in Chapter 4.

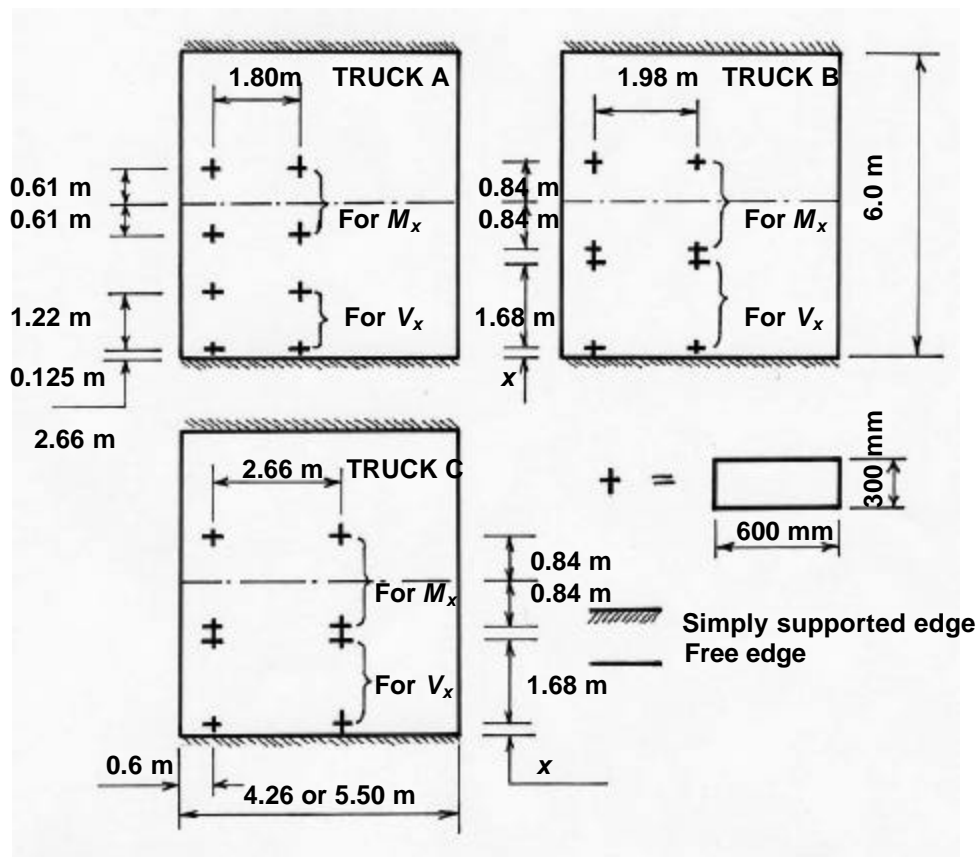

Figure 12 Truck placements on bridges with 6 m span

As listed in Table 1, five span lengths were considered for each of the two bridge widths. Plans of bridges with the other four span lengths are presented in Fig. 13. For each of these bridges, the dual-axle tandem of each design truck had the same relative position with respect to the mid-span of the bridge as shown in Fig. 12 for the 6-m span bridges.

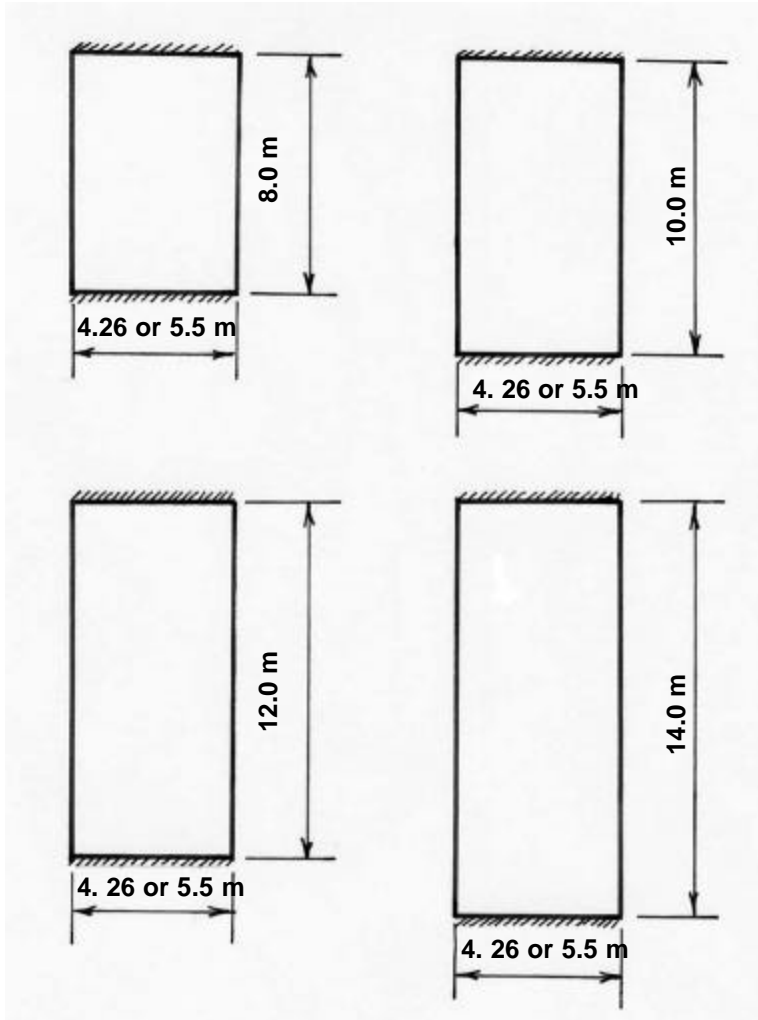

Figure 13 Plans of bridges with spans of 8, 10, 12 and 14 m

### 3.2 Confirmation of basic assumption

The fundamental premise of a simplified method of bridge analysis is that for a given transverse spacing between lines of wheels of trucks, the transverse distribution pattern of longitudinal responses (being longitudinal moments and shears) are independent of the spacing of axles and location of the transverse reference section. It is because of this premise that it was decided to develop the simplified methods by using only a dual-axle tandem of each design truck.

The premise noted above is verified in the following by analyzing a 14-m span bridge with a width of 4.26 m. As shown in Fig. 14, the bridge was analyzed under two load cases of Truck A2: (a) one load case being the same as used in the developmental analyses, i.e. with a two-axle tandem, and (b) in the other load case, both the two-axle tandems are positioned on the bridge to maximize the longitudinal moments. Reference sections for the two load cases are identified in Fig. 14. The average longitudinal moment intensities at these two reference sections are 230.1 and 231.0 kN·mm/mm, respectively.

As discussed later, for developmental analyses, the longitudinal moment intensities at the selected reference section were determined at three discrete points: at  $y = 0.0$ ,  $0.3$  and  $0.6$  m. For the two load cases illustrated in Fig. 14, the moment intensities were obtained by PLATO at the

same three reference points. Table 3 lists the moment intensities at these three reference points, along with the corresponding DF's. The fact the DF's for the two load cases are the same up to the second decimal place confirms the validity of the fundamental premise behind the simplified methods.

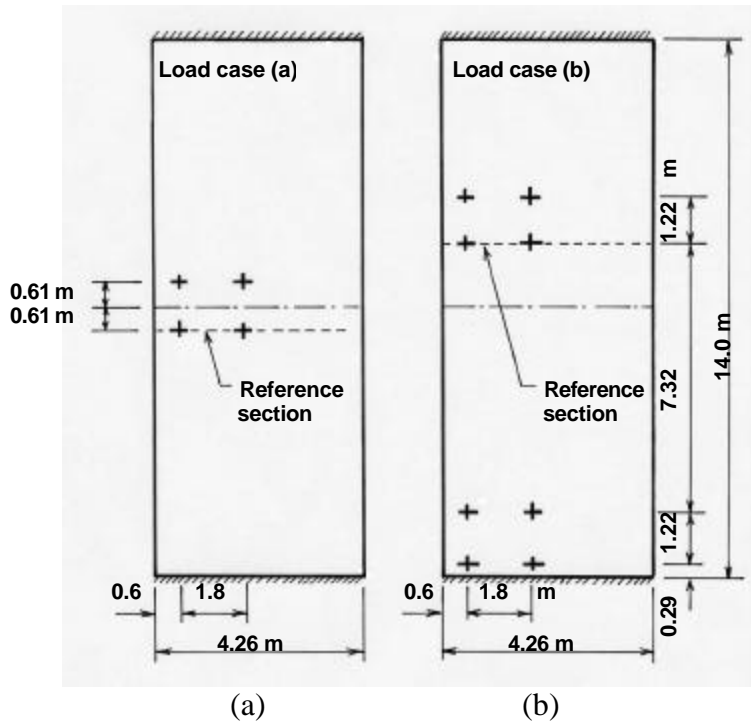

Figure 14 Two load cases for a bridge with a span of 14 m

Table 3 Longitudinal moment intensities and distribution factors for the two load cases shown in Fig. 14

<b>y, m</b>	<b>0.0</b>	<b>0.3</b>	<b>0.6</b>
Load case (a): $M_x$ at $x = 6.39$ m in kN·mm/mm	272.4	271.1	267.0
Load case (a): DF at $x = 6.39$ m	1.18	1.18	1.16
Load case (b): $M_x$ at $x = 8.83$ m in kN·mm/mm	273.8	272.4	268.4
Load case (b): DF at $x = 8.83$ m	1.18	1.18	1.16

It can be appreciated that since the transverse distance between the two lines of wheels of Truck A2 (wheel load distribution 50:50) is the same as that for the CHBDC Design Trucks, being 1.80 m, the simplified methods developed for the former can also be used in conjunction with the CHBDC truck loads.

### 3.3 Calculation of plank moments through plate analysis

Calculation of moments in a girder or a concrete plank,  $M_g$ , from orthotropic plate analysis requires some explanation for the uninitiated. Consider the distribution of longitudinal moment

intensity,  $M_x$ , at a given transverse section in an articulated plate subjected to a single eccentrically-placed vehicle. As shown in Fig. 15,  $M_x$  is likely to have its peak value, designated as  $M_{xmax}$ , at the nearer longitudinal free edge of the plate. As the reference point moves away from the longitudinal free edge,  $M_x$  would drop either gradually or rapidly. In any case, the total moment sustained by the most-heavily-loaded plank will be equal to area under the  $M_x$ -curve shown hatched in Fig. 15.

From articulated plate analysis, the plank moment can be calculated in the following three ways, listed in descending order of accuracy.

- (a) Calculate the total area under the  $M_x$ -curve over a width  $S$  by using a numerical integration technique, such as the Simpson's rule.
- (b) Assume that the distribution of  $M_x$  is linear over the plank width  $S$ , obtain the average value of moment intensity over  $S$  and multiply it with  $S$  to obtain the plank moment.
- (b) Calculate  $M_g$  by simply multiplying  $M_{xmax}$  with  $S$ .

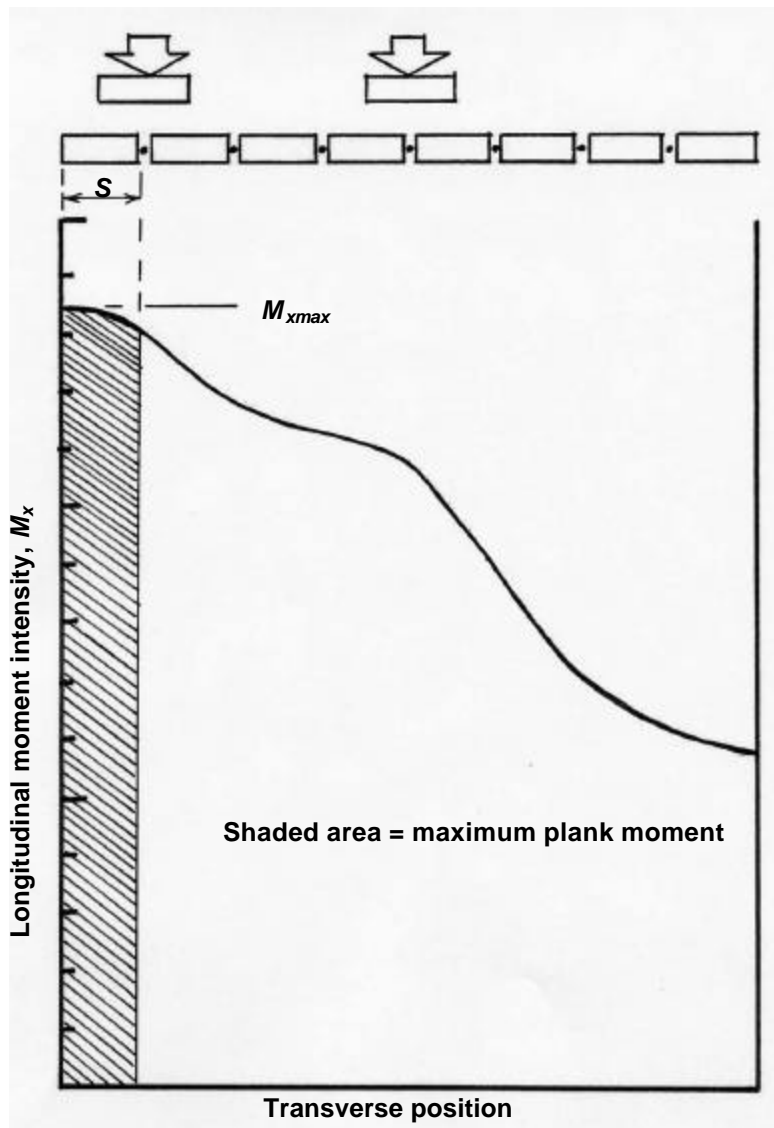

Figure 15 Longitudinal moment in a plank from orthotropic plate analysis

Unless the transverse distribution of  $M_x$  is very peaky in the vicinity of  $M_{xmax}$ , the margins of errors resulting from methods (b) and (c) are expected to be quite small. It was decided to use method (b) for obtaining the maximum plank moments. Since the smallest practical value of  $S$  is 0.61 m, it was further decided to obtain the plank moment over an outer width of 0.6 m, by taking the average of  $M_x$  at  $y = 0.0, 0.3$  and  $0.6$  m. Thus, the maximum plank moment  $M_g$  in kN-mm is obtained from the following equation in which  $M_x$  values are in kN-mm/mm.

$$[6] \quad M_g = 600 \left( \frac{(M_x)_{y=0.0m} + (M_x)_{y=0.3m} + (M_x)_{y=0.6m}}{3} \right)$$

If a larger value of  $S$  were considered for moment integration, the value of  $M_g$  would have been smaller, thus leading to a simplified method that will not be safe for all situations.

### 3.4 Calculation of $F$

According to the CHBDC (2000) simplified method, the plank moment  $M_g$  at a given transverse section is given by the following equation.

$$[7] \quad M_g = F_m M_{gavg}$$

where  $M_{gavg}$  is the average moment per plank obtained by dividing the total truck moment,  $M_t$ , at the transverse section under consideration by  $N$ , the number of planks in the bridge. The amplification factor  $F_m$  is obtained from the following equation.

$$[8] \quad F_m = \frac{SN}{F \left( 1 + \frac{mC_f}{100} \right)} \leq 1.05$$

where

$S$  = centre-to-centre spacing of planks  
 $F$  = a width dimension that characterizes load distribution for a bridge

For multispine bridges,  $F$  depends upon  $b$ . The factor  $m$  defines the difference in the actual bridge width from the width, which was used to develop values of  $F$ ; and  $C_f$  is a correction factor in % to account for changes in values of  $F$  due to changes in bridge width.

In the current development analyses,  $F$  will be determined for the smallest width of bridges under consideration, being 4.26 m, for which width  $m =$  zero. For the smallest bridge width, Equation [7] is rewritten as follows.

$$[9] \quad F_m = \frac{SN}{F}$$

or



$$[10] \quad F = \frac{SN}{F_m}$$

From Equation [7],  $F_m$  is given by:

$$[11] \quad F_m = \frac{M_g}{M_{gavg}}$$

For a given idealized bridge and loading case, the value of  $M_g$  is found from results of articulated plate analysis by using Equation [6]. Equation [11] is used to find  $F_m$ , and then Equation [10] to calculate  $F$ .

Each of the 10 idealized bridges, described in Table 1, was analysed under six design trucks (Fig. 7) placed according to the scheme illustrated in Fig. 11. Longitudinal moment intensities were obtained at the critical transverse section at the three reference points identified earlier. Values of  $M_x$  at these three reference points were entered on a spreadsheet to calculate values of  $F$  according to the method described above. The spreadsheet output is included in Appendix A.

### 3.5 Results

The numerical accuracy of the analyses was confirmed by plotting the values of  $F$  against  $b$ . When the results of some analyses did not conform to the general trend, the analysis was done again to correct data errors until all results conformed to a uniform trend. Figure 16 shows the  $F$ - $b$  plots corresponding to Trucks A2, B2 and C2 (50:50 wheel load distribution) on all bridges. It can be seen that all trends conform to uniform patterns.

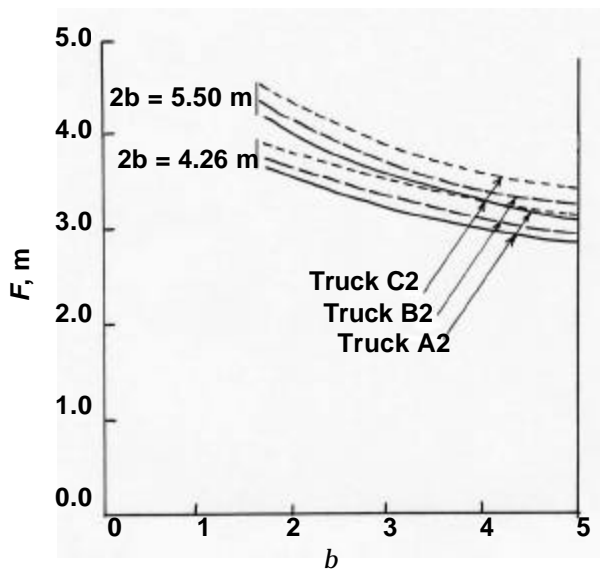

Figure 16  $F$ - $b$  plots corresponding to Trucks A2, B2 and C2 (Fig. 7)

A comparison of the  $F$ - $b$  curves for 50:50 and 60:40 distribution of wheel loads is provided in Fig. 17 (a) for bridges with a width of 5.50 m, and in Fig. 17 (b) for bridges with a width of 4.26 m. As expected, the values of  $F$  for the former distribution are larger, leading to smaller values of the amplification factor  $F_m$ .

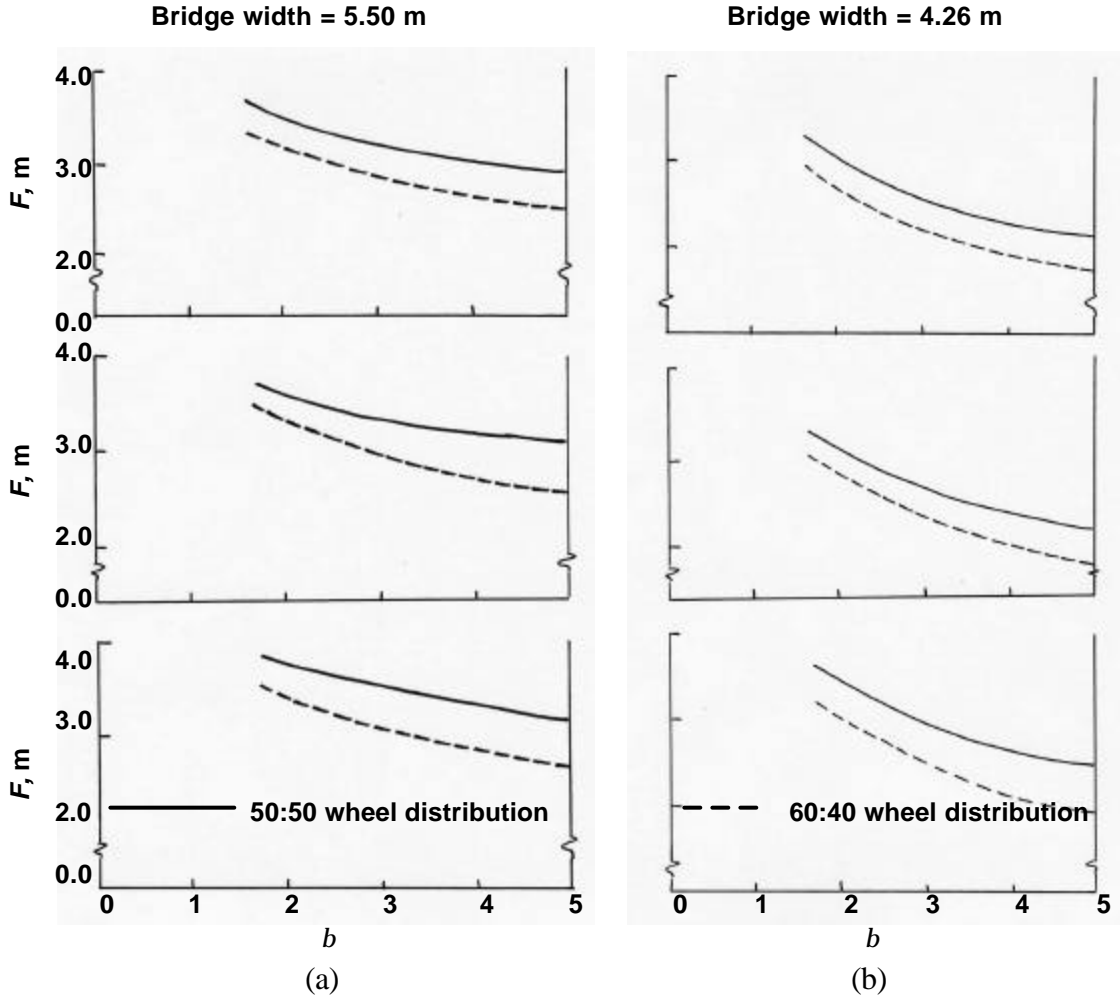

Figure 17 Values of  $F$  plotted against  $b$ : (a) wide bridges; (b) narrow bridges

A comparison of values of  $F$  for wide and narrow bridges plotted in Figs. 17 (a) and (b) will show that for the same value of  $b$ ,  $F$  is larger for the wider bridge. The difference between values of  $F$  for wide and narrow bridges is accounted for by  $C_f$ . It is noted that in CHBDC,  $C_f$  is given as a percentage, whereas in this report,  $C_f$  is defined to have the units of length. Values of  $F$  and  $C_f$  corresponding to Truck A2 (Fig. 7) are plotted in Fig. 18 against  $b$ . Since both the  $F$ - $b$  and  $C_f$ - $b$  curves are not straight lines, they can be easily represented by a polynomial. In the interest of simplicity, however, it was decided to represent them by simple equations, which represent a straight line. As also shown in Fig. 18, anchoring the straight lines at  $b = 2.0$  and  $4.0$  ensures that within the practical zone of  $b$  (between 1.5 and 3.5), the error involved in representing the actual curves by straight lines is very small. For example, the  $F$ - $b$  curve of Fig. 18 is represented by the following equation.

$$[12] \quad F = 4.10 - 0.27b$$

The differences between the actual values of  $F$  and those given by Equation [12] are noted in Table 4, in which it can be seen that the percentage error is quite small, especially when  $b$  lies between 2.0 and 4.0.

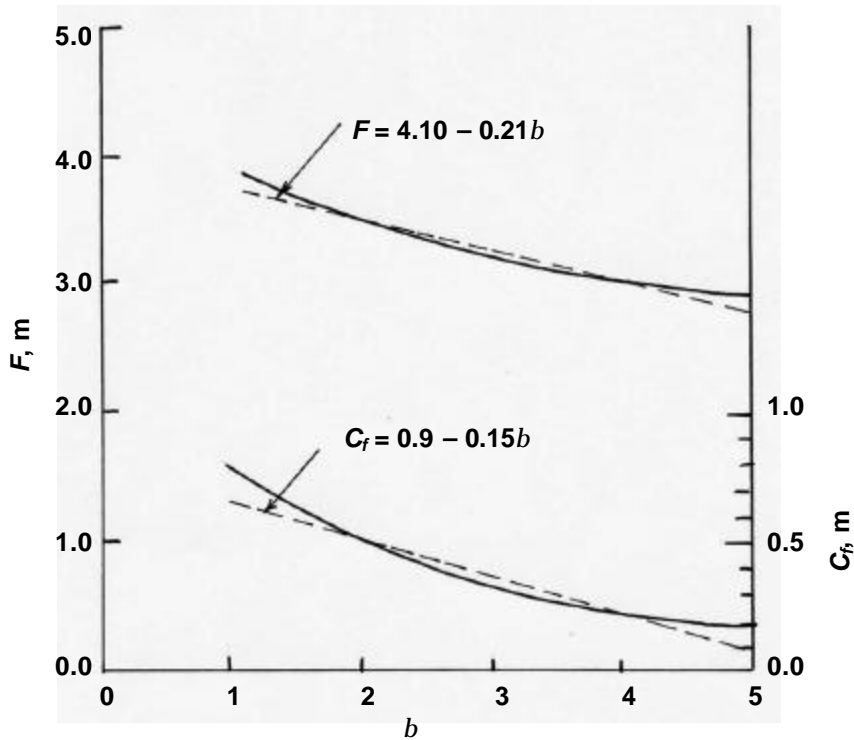

Figure 18  $F$  and  $C_f$  corresponding to Truck A2 plotted against  $b$

Table 4 Comparison of values of  $F$  obtained by articulated plate analysis and Equation [12] for Truck A2

$b$	Actual $F$ , m	$F$ , m by Equation [12]	Percentage difference between values of $F$
1.65	3.63	3.65	0.6
2.11	3.47	3.53	1.7
2.72	3.29	3.36	2.1
3.52	3.12	3.15	1.0
5.04	2.93	2.73	6.8

### 3.6 Proposed method for longitudinal moments

The proposed method for obtaining longitudinal moments in single-lane shear-connected concrete plank bridges is the same as specified in Clause 5.7.1.3 of the CHBDC (2000), except the following.

The value of the amplification factor  $F_m$  shall be obtained from the following equation.

$$[13] \quad F_m = \frac{SN}{F + mC_f}$$

where values of  $F$  and  $C_f$  are obtained from the expressions given in Table 5, and  $m$  is given by the following equation, in which the bridge width,  $2b$ , is in metres.

$$[14] \quad m = \frac{2b - 4.26}{1.24}$$

If the value of  $m$  is greater than 1.0, it shall be assumed to be 1.0.

Table 5 Expressions for  $F$  and  $C_f$  for longitudinal moments in single-lane shear-connected concrete plank bridges

Design truck	Wheel load distribution	$F, m$	$C_f, m$
A1	60:40	$3.73 - 0.26 b$	$0.75 - 0.12 b$
A2	50:50	$4.10 - 0.27 b$	$0.75 - 0.12 b$
B1	60:40	$3.85 - 0.27 b$	$0.75 - 0.12 b$
B2	50:50	$4.05 - 0.22 b$	$0.75 - 0.12 b$
C1	60:40	$4.65 - 0.45 b$	$0.90 - 0.15 b$
C2	50:50	$4.18 - 0.21 b$	$0.90 - 0.15 b$

Since the transverse wheel spread and the distribution of wheel loads of the axles of Truck A2 (see Fig. 7) are the same as those of the CHBDC CL-W Truck, the above method for Truck A2 can also be used for the CHBDC design loads.

### 3.7 Example

The use of the proposed method is illustrated with the help an actual bridge described by Bakht et al. (2001). The Harris Creek Bridge has a width and span of 5.84 and 10.63 m, respectively. As shown in Fig. 19, it has seven planks, each 819 mm wide.

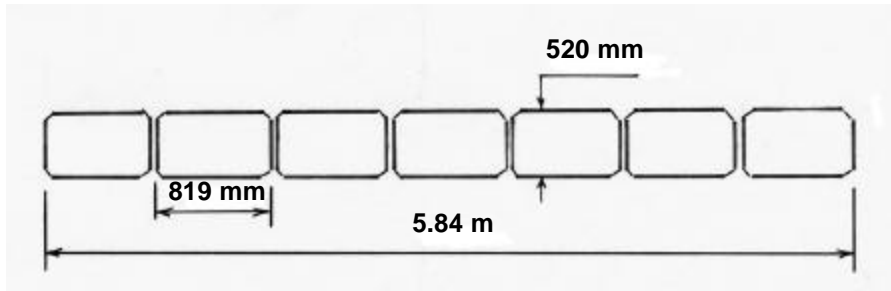

Figure 19 Cross-section of Harris Creek Bridge

It is required to calculate the maximum longitudinal moment in a plank due to both Trucks A1 and A2. From Equation [4]:

$$K = \frac{1}{3} - \frac{0.21 \times 520}{819} = 0.20$$

From Equation [5]:

$$b = p \left( \frac{5.84}{11.16} \right) \left( \frac{0.3833}{0.20} \right)^{0.5} = 2.39$$

Equation [14] gives  $m = 1.27$ . Since this value is larger than 1.0,  $m$  is taken as 1.0. For Truck A1, values of  $F$  and  $C_f$  are calculated from expressions given in Table 5.

$$F = 3.73 - 0.26 \times 2.39 = 3.11 \text{ m}$$

$$C_f = 0.75 - 0.12 \times 2.39 = 0.46 \text{ m}$$

For Truck A2, the corresponding values of  $F$  and  $C_f$  are found to be 3.45 and 0.46 m. Equation [13] gives  $F_m = 1.61$  for Truck A1, and 1.47 for Truck A2.

The longitudinal position, shown in Fig. 19, is the same for A1 and A2 trucks. It is readily found that the total moment,  $M_t$ , under the second axle from the left hand side is 723.0 kN·m. Dividing this moment by  $N$ , the number of planks ( $= 7$ ), one gets  $M_{g \text{ avg}} = 103.3$  kN·m.

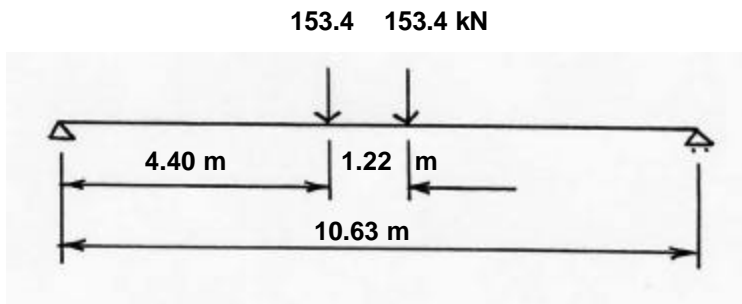

Figure 19 Longitudinal position of Trucks A1 and A2 on the span of Harris Creek Bridge

Multiplying  $M_{g \text{ avg}}$  with the relevant values of  $F_m$ , one gets the girder moment  $M_g$  for Truck A1 = 166.3 kN·m, and for Truck A2 151.9 kN·m.

#### 4. SIMPLIFIED METHOD FOR LONGITUDINAL SHEAR

##### 4.1 Locating longitudinal section for maximum longitudinal shear intensity

The longitudinal moment intensity is denoted as  $V_x$ . It is expected that the maximum value of  $V_x$  should be at the edge of a patch load. However, because of difficulties in the convergence of results, the orthotropic theory used in the computer program PLATO gives the maximum intensity some distance away from the patch load. To illustrate this point, results of analysis of a plate with span and widths of 6.0 and 4.26 m, respectively, are presented in Fig. 20.

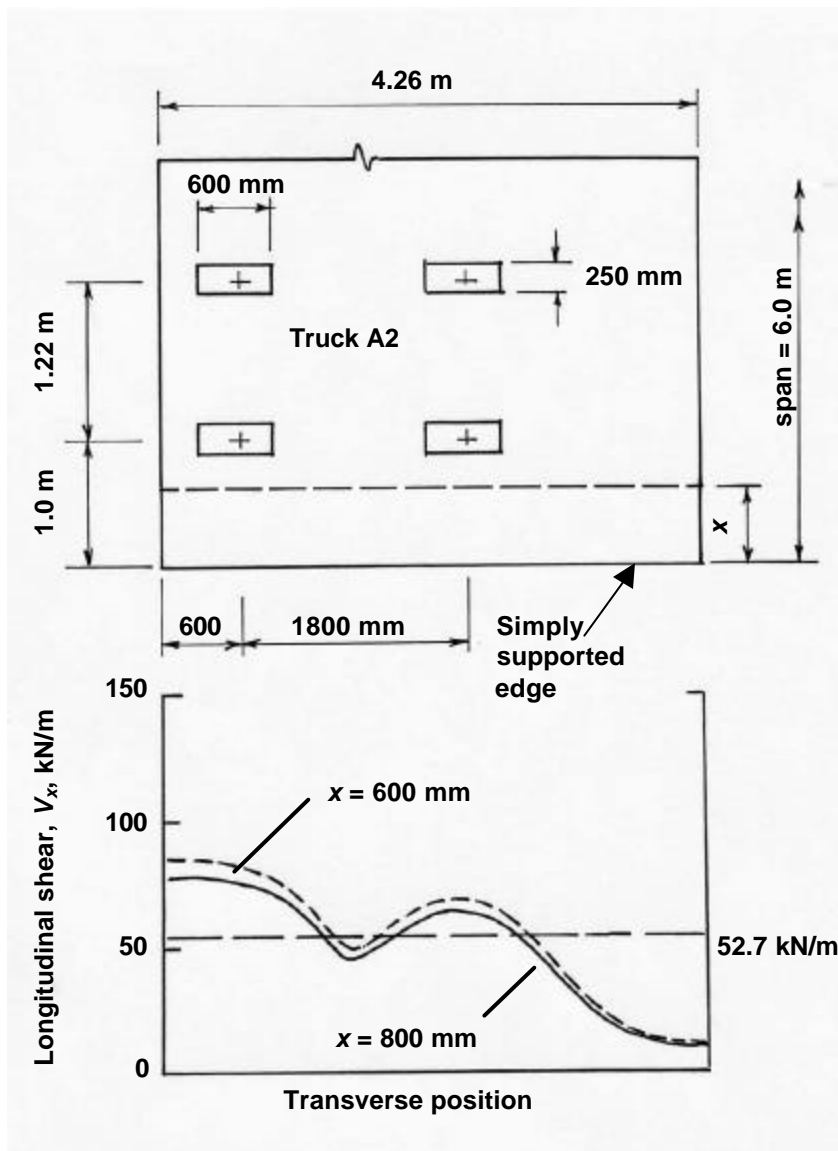

Figure 20. Longitudinal shear intensity at two transverse sections

As shown in Fig. 20, the two-axle tandem of Truck A2 is placed in such a way that the centre of one axle is 1.0 m away from the nearer simply supported edge.  $V_x$  due to this loading is investigated at different transverse sections, a distance  $x$  from the nearer supported edge of the plate. Since the total longitudinal shear at any transverse section between the load and the supported edge should be the same, the total area under the  $V_x$  curve at any transverse section within this region should also be the same. It can be seen in Fig. 20 that the total areas under the  $V_x$  curves at  $x = 600$  and  $800$  mm are not the same, thus indicating the need for determining the optimum location of the transverse section. The  $V_x$  curves of Fig. 20 also show that similar to  $M_x$ , the peak value of  $V_x$  lies at the nearer longitudinal free edge of the plate.

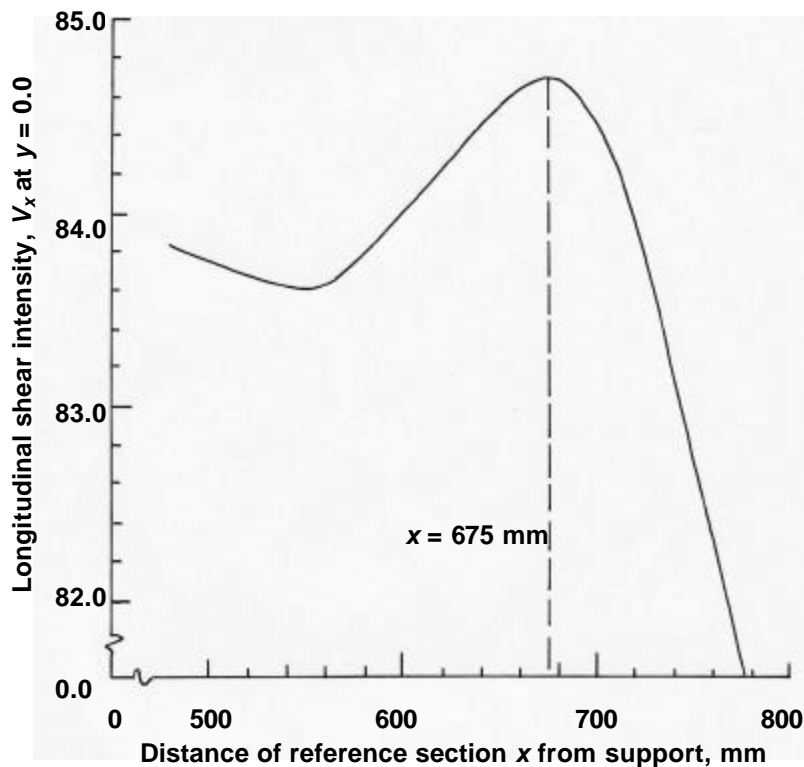

Figure 21 Longitudinal shear intensity for the articulated plate and loads shown in Fig. 20

PLATO was used to find  $V_x$  at  $y = 0.0$  and different values of  $x$ . The outcome of this exercise is presented in Fig. 21, in which it can be seen that for the load case under consideration, the peak value of  $V_x$  lies at  $y = 675$  mm. It is emphasized that the vertical scale of Fig. 21 is highly exaggerated, because of which even small differences in the magnitudes of  $V_x$  appear large. The total shear for the loads shown in Fig. 20, between the supported edge of the plate and the loads, is 224.47 kN. At  $y = 675$  mm, the total area under the  $V_x$  curve for 55 harmonics, obtained by numerical integration using the Simpson's rule, was found to be 224.47 kN, only 0.3% larger than the theoretical value. It was thus confirmed that the PLATO results for longitudinal shear converge almost fully at the optimum transverse reference section.

Through subsequent analyses, it was found that the transverse section at  $x = 675$  mm was also the optimum reference section for all other articulated plates considered in the developmental

studies. Accordingly, in all analyses relating to the development of the method for longitudinal shear, the loads were placed as shown in Fig. 20, and  $V_x$  was investigated at  $y = 675$  mm.

## 4.2 Results

The procedure for determining of  $F$  and  $C_f$  for longitudinal moments is described in Chapter 3. The values of  $F$  and  $C_f$  for longitudinal shear, determined by using the same procedure, are plotted in Fig. 22 against  $b$ . Appendix B contains the results of these analyses.

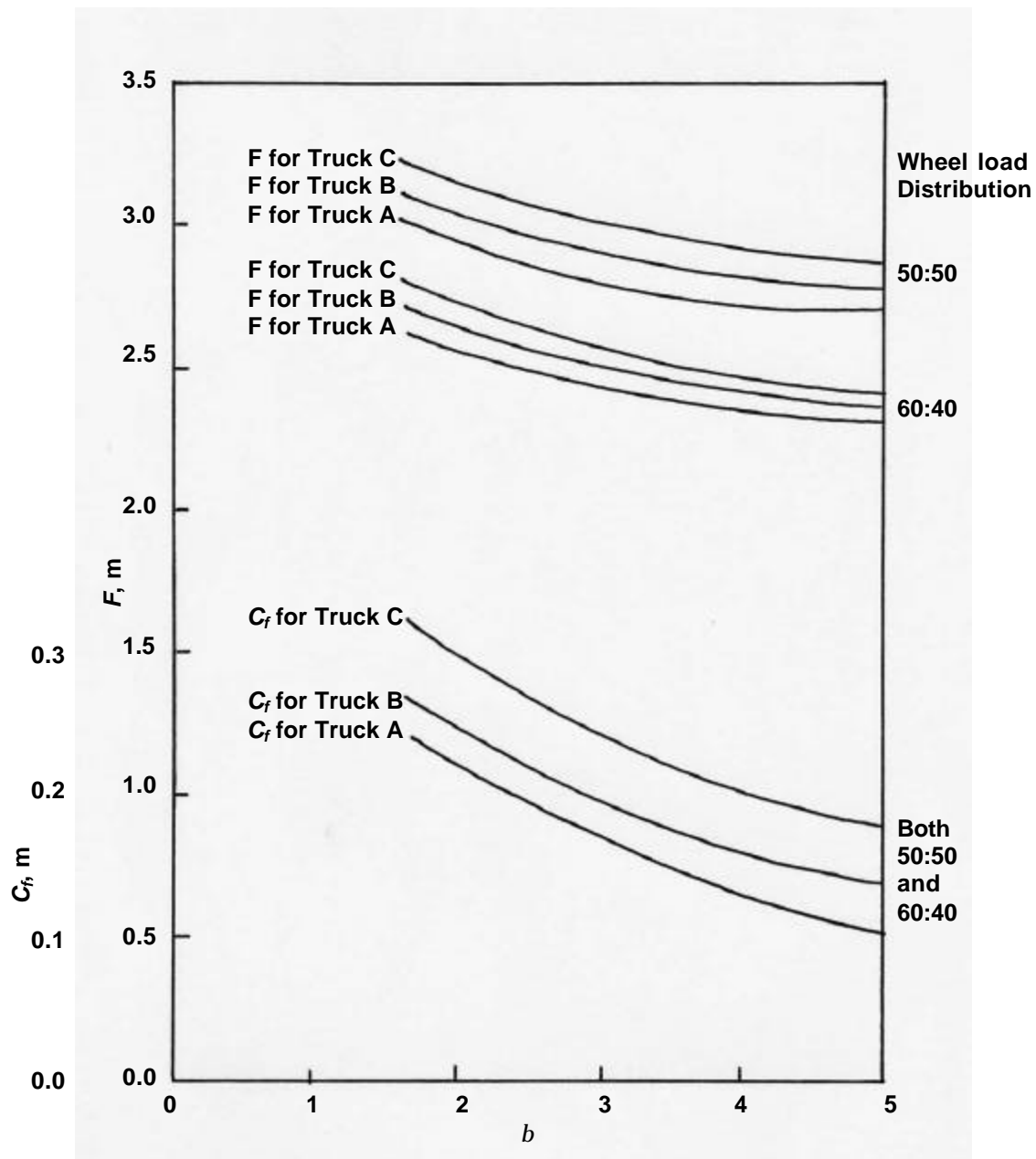

Figure 22 Values of  $F$  and  $C_f$  for longitudinal shear plotted against  $\beta$



### 4.3 Proposed method for longitudinal moments

The proposed method for obtaining longitudinal shears in single-lane shear-connected concrete plank bridges is the same as specified in Clause 5.7.1.5 of the CHBDC (2000), except the following.

The value of the amplification factor  $F_v$  shall be obtained from the following equation.

$$[15] \quad F_v = \frac{SN}{F + mC_f}$$

where values of  $F$  and  $C_f$  are obtained from the expressions given in Table 6, and  $m$  is given by the following equation, in which the bridge width,  $2b$ , is in metres.

$$[14] \quad m = \frac{2b - 4.26}{1.24}$$

If the value of  $m$  is greater than 1.0, it shall be assumed to be 1.0.

Table 6 Expressions for  $F$  and  $C_f$  for longitudinal shears in single-lane shear-connected concrete plank bridges

Design truck	Wheel load distribution	$F, m$	$C_f, m$
A1	60:40	$2.76 - 0.10 b$	$0.30 - 0.04 b$
A2	50:50	$3.16 - 0.10 b$	$0.30 - 0.04 b$
B1	60:40	$2.90 - 0.17 b$	$0.28 - 0.04 b$
B2	50:50	$3.22 - 0.10 b$	$0.28 - 0.04 b$
C1	60:40	$2.90 - 0.11 b$	$0.40 - 0.05 b$
C2	50:50	$3.38 - 0.11 b$	$0.40 - 0.05 b$

Since the transverse wheel spread and the distribution of wheel loads of the axles of Truck A2 (see Fig. 7) are the same as those of the CHBDC CL-W Truck, the above method for Truck A2 can also be used for the CHBDC design loads.

### 4.4 Example

The Harris Creek Bridge, analyzed for longitudinal moments in Section 3.6 is investigated for longitudinal shear for Truck A1 for the load position shown in Fig. 23. The value of  $b$  for this bridge was found to be 2.39, and the value of  $m$  was taken as 1.0.

From the expressions given in Table 6 for Truck A1:

$$F = 2.76 - 0.10 \times 2.39 = 2.52$$

$$C_f = 0.30 - 0.04 \times 2.39 = 0.20$$

For the above values of  $F$  and  $C_f$ , Equation [15] gives  $F_v = 2.01$ . As expected  $F_v$  is larger than  $F_m$ , for which the corresponding value was found to be 1.61. It is recalled that in a given bridge, the distribution pattern for longitudinal shear is peakier than that for longitudinal moments (e.g. Bakht and Jaeger 1985).



Figure 23 Longitudinal position of Truck A1 on the span of the Harris Creek Bridge

For the load position shown in Fig. 23, the maximum shear,  $V_t$ , is found to be 285.6 kN. Dividing this value by 7, the number of planks in the bridge, one obtains  $V_{g\ avg} = 40.8$  kN/ plank. The maximum longitudinal shear in a plank of the Harris Creek Bridge,  $V_g$ , obtained by multiplying 40.8 with 2.01, = 82.0 kN.

## 5. SIMPLIFIED METHOD FOR TRANSVERSE SHEARS

### 5.1 Developmental analyses

Bakht et al. (2001) have developed a simplified method of analysing articulated plates for transverse shear forces in shear keys due to design loads, in which the centre-to-centre distance between the two lines of wheels was assumed to be 1.2 m. A new simplified method has now been developed for the six design trucks of Fig. 7.

Bakht et al. (2001) had developed their simplified method for only wide single-lane bridges (with a width of 5.5 m) on the ground that the values of transverse shears thus determined are on the safe-side for narrower bridges. The same approach was utilised for the current exercise. It was found that the maximum intensity of transverse shear is induced when the vehicle is placed as close to a longitudinal free edge of the bridge, and the transverse shear intensity is investigated between the other longitudinal edge of the bridge and the closer line of wheels.

Similarly to longitudinal shear intensity, the orthotropic plate method of PLATO does not give the maximum intensity of transverse shear,  $V_y$ , at the edge of a rectangular patch load; Bakht et al. (2001) have also made the same observation. By conducting the kind of exercise reflected in the plot of Fig. 21, locations of critical longitudinal sections for were determined for  $V_y$  for each design truck. As expected, the location of the critical section depended upon the distance between the lines of wheels, and not upon the proportions of wheel load distribution. The locations of the critical longitudinal sections for the three types of trucks are trucks are shown in Fig. 23 along with the corresponding transverse positions of the trucks.

In the case of design trucks with unequal sharing of wheel loads, the heavier loads were placed near the critical section (Fig. 23).

Similar to Bakht et al. (2000), the smallest practical value of the spacing of shear keys,  $S_{sk}$ , was assumed to be 1.6 m in the developmental analyses. It is recalled that the use of the smallest value of  $S_{sk}$  leads to a safe simplified method for larger spacings of shear keys. For each articulated plate with a width of 5.5 m, the design trucks were placed centrally in the longitudinal

direction, and transversely as shown in Fig. 23. The maximum value of shear in a shear key of each idealized bridge was calculated from PLATO results by integrating  $V_y$  over a length of 1.6 m, at intervals of 0.2 m. The Simpson's rule was used for the numerical integration.

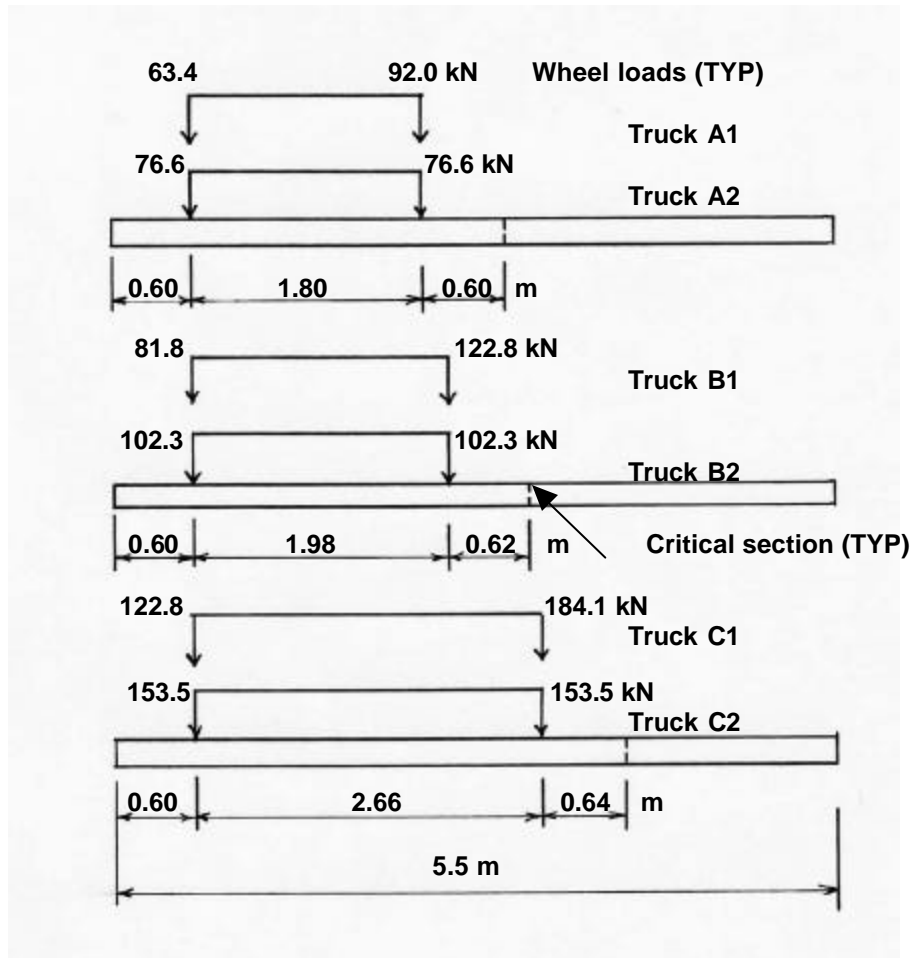

Figure 24 Transverse truck positions to induce maximum transverse shear

Results of analyses and calculations leading to the maximum values of shear in a shear key are given in Appendix C in a spreadsheet format. Advantage was taken of the symmetry of loading in the longitudinal direction of the bridge by integrating the area under the  $V_y$  curve over only half the length under consideration, i.e. over 0.8 m. The numerical accuracy of the input data was confirmed by plotting the calculated values of the shear force per shear key against  $b$ . For trucks with uneven distribution of wheel loads, these plots are given in Fig. 24 (a), and for trucks with equal distribution of wheel loads in Fig. 24 (b).

It can be seen in Figs. 24 (a) and (b) the shear- $b$  plots conform to well-defined patterns. In addition, for a given value of  $b$ , the maximum transverse shear force per shear key is higher for the heavier truck. Uneven distribution of wheel loads also leads to higher shear forces.

Using the results of analyses given in Appendix C, it would have been a straightforward matter to develop graphical charts similar to those given in CHBDC Clause 5.7.1.8. However,

the nearly linear shear- $b$  curves of Figs. 24 (a) and (b) suggested that a user-friendlier format can be adopted for the exercise at hand. Similar to the methods for longitudinal moments and shears, given in Chapters 3 and 4 respectively, the proposed method for transverse shears is based on the value of  $b$ .

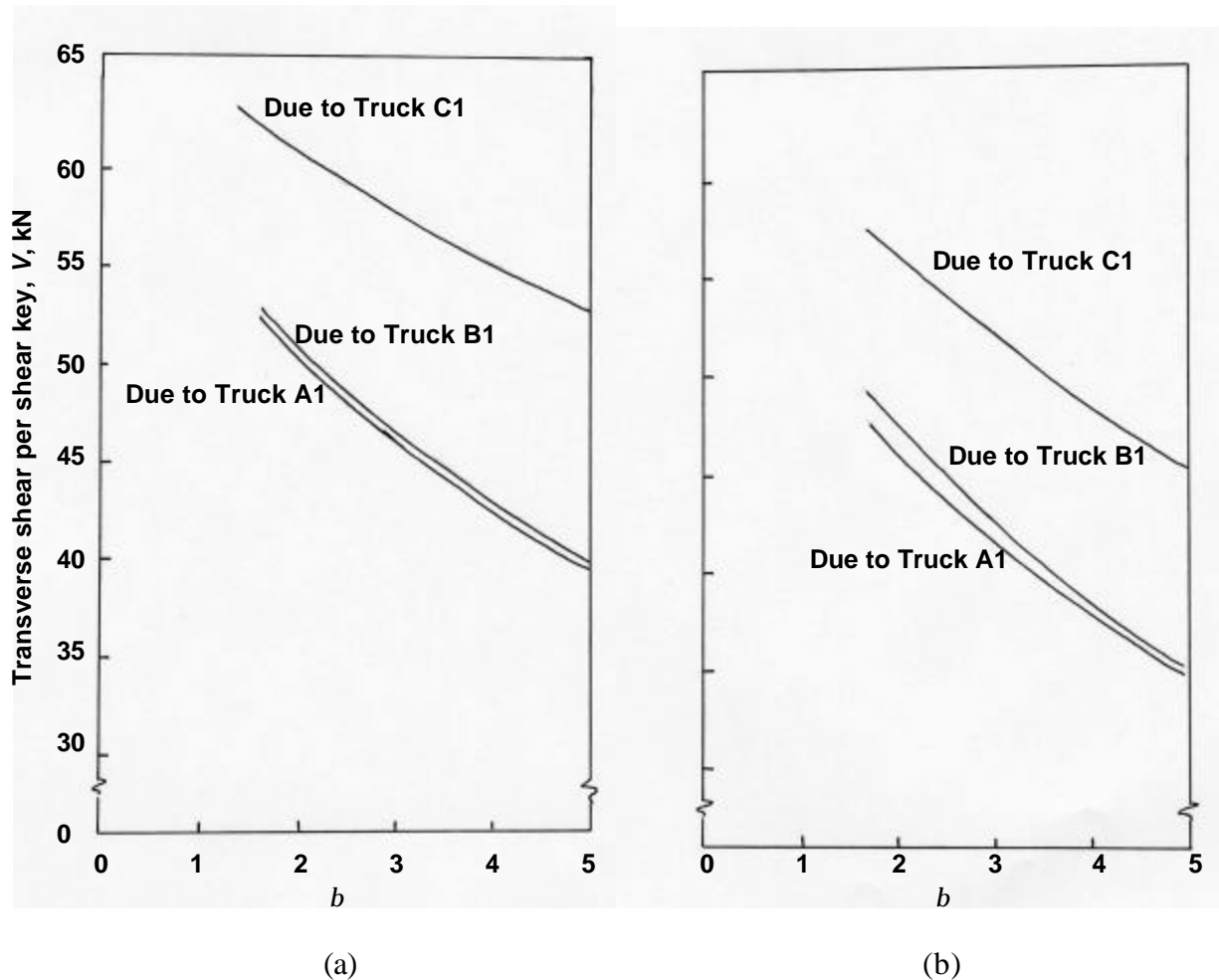

Figure 25 Transverse shear in shear keys at a spacing of 1.6 m: (a) due to trucks with 60:40 wheel load distribution; (b) due to trucks with 50:50 wheel load distribution

Values of transverse shear per shear key,  $V$ , obtained by orthotropic plate analyses are compared in Table 7 with those obtained by the proposed method. As shown in this table, within the practical range  $b$  (from 1.65 to 3.52) the values of  $V$  given by the proposed simplified method are within 3% of the values obtained by rigorous analysis. Even outside the practical range of  $b$ , the difference between the two sets of values is within 6%, thus confirming the accuracy of the proposed method.

Table 7 Comparison of transverse shear per shear key obtained by rigorous and simplified methods for shear key spacing of 1.6 m

Design Truck	Method of analysis/ Difference in values	V in kN per shear key for $b =$				
		1.65	2.11	2.72	3.52	5.04
A1	Orthotropic plate	39.2	44.3	47.0	50.0	53.0
	$V = 58 - 4b$	37.8	43.9	47.1	49.6	51.4
	Difference	3.6%	0.9%	0.2%	0.8%	3.0%
A2	Orthotropic plate	34.5	39.8	42.7	45.6	48.6
	$V = 54 - 4b$	37.8	43.9	47.1	49.6	51.4
	Difference in percentage	3.6%	0.9%	0.2%	0.8%	3.0%
B1	Orthotropic plate	39.5	45.0	47.8	50.3	52.7
	$V = 60 - 4b$	39.8	45.9	49.1	51.6	53.4
	Difference in percentage	0.8%	2.0%	2.7%	2.6%	1.3%
B2	Orthotropic plate	34.9	40.9	44.1	46.9	49.5
	$V = 58 - 5b$	32.8	40.4	44.4	47.5	49.8
	Difference in percentage	6.0%	1.2%	0.7%	1.3%	0.6%
C1	Orthotropic plate	52.5	56.9	59.0		
	$V = 68 - 3b$	52.9	57.4	59.8		
	Difference in percentage	0.8%	0.9%	1.4%		
C2	Orthotropic plate	45.3	50.5	53.2	55.6	58.0
	$V = 64 - 4b$	43.8	49.9	53.1	55.6	57.4
	Difference in percentage	3.3%	1.2%	0.2%	0.0%	1.0%

## 5.2 Proposed method

The maximum shear force  $V_{y \max}$  in shear keys, spaced at a centre-to-centre distance of  $S_{sk}$  in metres, shall be obtained from the following equation.

$$[15] \quad V_{y \max} = V \left( \frac{S_{sk}}{1.6} \right)$$

where the datum value of the transverse shear force  $V$  for  $S_{sk} = 1.6$  m, is obtained from the expressions given in Table 8 for the design truck under consideration. The value of  $b$ , used these expressions shall be obtained from Equation [5]. In the case of continuous shear keys,  $S_{sk}$  shall be assumed to be 1.0 m, and the value of  $V_{y \max}$  thus obtained shall be for a 1.0 m length of the shear key.

The value of  $V$  in kN for the CL-W Design Truck of the CHBDC (2000) shall be obtained from the following equation, in which  $W$  is the total weight of the design truck in kN.

$$[16] \quad V = \left( \frac{0.4W}{306.8} \right) (54 - 4b)$$

Table 8 Expressions for  $V$ , transverse shear in single-lane shear-connected concrete plank bridges with a shear key spacing of 1.6 m

Design truck	Wheel load distribution	$V$ , kN / shear key
A1	60:40	$58 - 4 b$
A2	50:50	$54 - 4 b$
B1	60:40	$60 - 5 b$
B2	50:50	$58 - 5 b$
C1	60:40	$68 - 3 b$
C2	50:50	$64 - 4 b$

When the total weight of the two closely-spaced axles of a truck are different from those of the CL-W Truck or those given in Fig. 7, expressions given in Table 8 can be used for trucks with different spacings between centres of their lines of wheels. It is noted that in this table,  $4P$  refers to the total weight on the two closely-spaced axles.

Table 9 Alternative expressions for  $V$ , transverse shear in single-lane shear-connected concrete plank bridges with a shear key spacing of 1.6 m

Spacing between lines of wheels, mm	Wheel load distribution	$V$ , kN / shear key
A1	60:40	$(4P/306.8) \times (58 - 4 b)$
A2	50:50	$(4P/306.8) \times (54 - 4 b)$
B1	60:40	$(4P/409.2) \times (60 - 5 b)$
B2	50:50	$(4P/409.2) \times (58 - 5 b)$
C1	60:40	$(4P/613.8) \times (68 - 3 b)$
C2	50:50	$(4P/613.8) \times (64 - 4 b)$

### 5.3 Example

The Harris Creek Bridge, described in Section 3.7, is analysed for transverse shear under Truck A1 (see Fig. 7); this bridge has welded shear keys with a centre-to-centre distance of 2.03 m. The value of  $b = 2.38$ .

From Table 8,  $V = 58 - 4 \times 2.38 = 48.5$  kN. From Equation [15], the maximum transverse shear,  $V_{y \max}$ , in a shear key of the Harris Creek Bridge =  $2.03 \times 48.5 / 1.6 = 61.5$  kN.

## 6. REFERENCES

- Bakht, B. and Jaeger, L.G. 1985. *Bridge Analysis Simplified*. McGraw Hill, New York.
- Bakht, B., and Mufti, A.A. 2001. Load distribution in shear-connected concrete plank bridges. CSCE Annual Conference, held in Victoria, BC (proceedings on CD ROM, hardcopy, without pagination).
- Bakht, B., Mufti, A.A., and Desai, Y.M. 2002. *PLATO User Manual*, ISIS Canada, University of Manitoba.
- Bakht, B., Mufti, A.A., and Sargent, D.D. 2001. Assessment of stresses in welds of shear-connected concrete plank bridges. CSCE Annual Conference, held in Victoria, BC (proceedings on CD ROM, hardcopy, without pagination).
- CHBDC. 2002. *Canadian Highway Bridge Design Code CAN/CSA-S6-00*. Canadian Standards Association, Toronto.
- Cusens, A.R. and Pama, R.P. 1975. *Bridge Deck Analysis*. Wiley, London.
- Spindel, J.E. 1961. A study of bridge slabs having no transverse flexural stiffness. Ph.D. thesis. London University.

**SIMPLIFIED ANALYSIS OF SKEW  
SINGLE-LANE SHEAR-CONNECTED CONCRETE PLANK BRIDGES**

by

Baidar Bakht

21 Whiteleaf Crescent  
Scarborough ON M1V 3G1

[bbakht@rogers.com](mailto:bbakht@rogers.com)

Phone: (416) 292 4391

Fax: (416) 292 7374

June 19, 2004



**EXECUTIVE SUMMARY**

The proposed simplified method for skew bridges involves the following two steps.

- (a) By assuming that the bridge is right with a span equal to the skew span of the original skew bridge, obtain the maximum longitudinal shear per plank by the simplified method proposed by Bakht (2004) for right bridges.
- (b) Calculate the magnifier  $C_v$  from the following equation.

$$C_e = 1 + \frac{Ly}{8000}$$

where the span length  $L$  is in metres and skew angle  $y$  is in degrees. Multiply the longitudinal shear per plank obtained in (a) with  $C_v$ . The shear thus obtained will be the longitudinal shear per plank in the skew bridge.

## 1. INTRODUCTION

A simplified method has been presented by Bakht (2004) to determine longitudinal moments and shears due to a variety of design live loads in single-span shear-connected concrete plank bridges with zero angle of skew (i.e. in right bridges).

The British Columbia Ministry of Forests wanted the above simplified method to be extended to skew bridges through the use of the kind of multipliers that are specified in the Clause CA5.1 (b)(i) of the Commentary to the CHBDC (2001). It is recalled that the CHBDC multipliers are applicable to only slab-on-girder bridges.

This report provides the details of the simplified method for skew shear-connected bridges with one lane, and subjected to a design truck, in which the centres of the two lines of wheels are 1.8 m apart and the loads between the two lines of wheels are divided 50:50; this truck is identified as Truck A2 by Bakht (2004).

## 2. BACKGROUND TO CHBDC METHOD

The CHBDC method, referred to above, provides values of the skew multipliers based on two dimensionless parameters,  $e$  and  $h$ , which are defined as follows; these parameters, relating to the idealisation of the bridge as an orthotropic plate, were derived by Jaeger et al. (1988), and are described by Jaeger and Bakht (1989).

$$[1] \quad e = \frac{S \tan \gamma}{L}$$

$$[2] \quad h = 0.5 \left( \frac{D_y}{D_x} \right) \left( \frac{L}{S} \right)^4$$

where  $S$  is the girder spacing,  $\gamma$  is the angle of skew,  $L$  is the span length,  $D_y$  is the transverse flexural rigidity per unit length, and  $D_x$  is the longitudinal flexural rigidity per unit width.

As discussed by Bakht (2004), the shear-connected bridges under consideration are analyzed as articulated plates, a special case of the orthotropic plate in which  $D_y$  is equal to zero. From Equation [2], it can be seen that for articulated plates, in which  $D_y = 0$ ,  $h$  is always zero. It is concluded that the longitudinal shear is likely to depend only on the angle of skew.

Bakht (1988) has shown that when skew bridges are analysed as right bridges by assuming that the equivalent span of the right bridge (Fig. 1 b) is the same as the skew span of the skew bridge (Fig. 1 a), the analysis always gives conservative (i.e. safe) results for longitudinal moments. The longitudinal shears obtained by the simplified method, however, are smaller than the same response in the skew bridge. It is for this reason that the CHBDC (2001) multipliers, which are always greater than 1.0, are applied to only longitudinal shears. It can be seen from Fig. 1 (a) that the skew span is always greater than the right span.

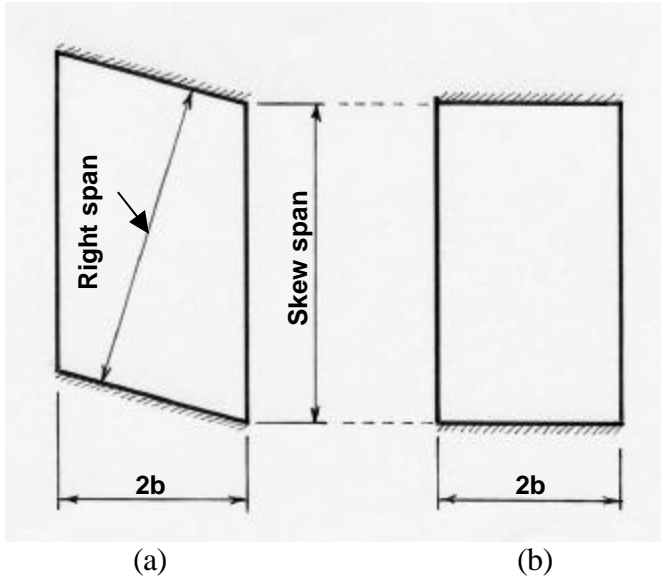

Figure 1 Analysing skew bridge as right: (a) skew bridge; (b) equivalent right bridge

### 3. ANALYSIS OF SKEW BRIDGE AS RIGHT

Bakht (1988) has shown that the effect of vehicles with an orthogonal pattern of wheel loads of a truck on a skew bridge (Fig. 2 a) can be analysed realistically by analysing the skew bridge as right in which the orthogonal pattern of wheel loads is made skew so that longitudinal positions of the loads on the equivalent right bridge with respect to the transverse reference section are the same as those on the original skew bridge (Fig. 2 b).

Table 1 Parameters of idealized bridges

Designation	Span, m	$D_x$ , kN·mm <sup>2</sup>	$D_x$ , kN·mm <sup>2</sup>	$b$
6N	6.0	125,052	24,439	5.04
8N	8.0	283,897	64,242	3.52
10N	10.0	434,224	104,958	2.72
12N	12.0	540,146	150,006	2.11
14N	14.0	630,000	210,600	1.65
6W	6.0	125,052	40,838	5.04
8W	8.0	283,897	106,583	3.52
10W	10.0	434,224	175,303	2.72
12W	12.0	540,146	250,011	2.11
14W	14.0	630,000	351,540	1.65

In the previous study (Bakht 2004), it was shown that the maximum intensities in bridges under consideration are induced in the outer-most plank, when the design truck is placed as eccentrically as possible. Accordingly, it was decided to use the same governing longitudinal and

transverse load position of the dual-axle tandem of the A2 Truck with respect to the closer longitudinal and transverse free edges of the articulated plate; this position is shown in Fig. 2 (a) for the skew bridges, and in Fig. 2 (b) for the equivalent right bridges. As shown in the latter figure, the longitudinal shears were investigated at transverse section that is 765 mm from the closer supported edge. Similar to the previous study, the span length  $L$  was varied from 6 to 14 m, but in steps of 4.0 m. Two bridge widths were considered: 4.26 and 5.50 m. The orthotropic plate properties for the 10 idealised bridges were the same as used in the previous study. These properties are listed in Table 1 for easy reference.

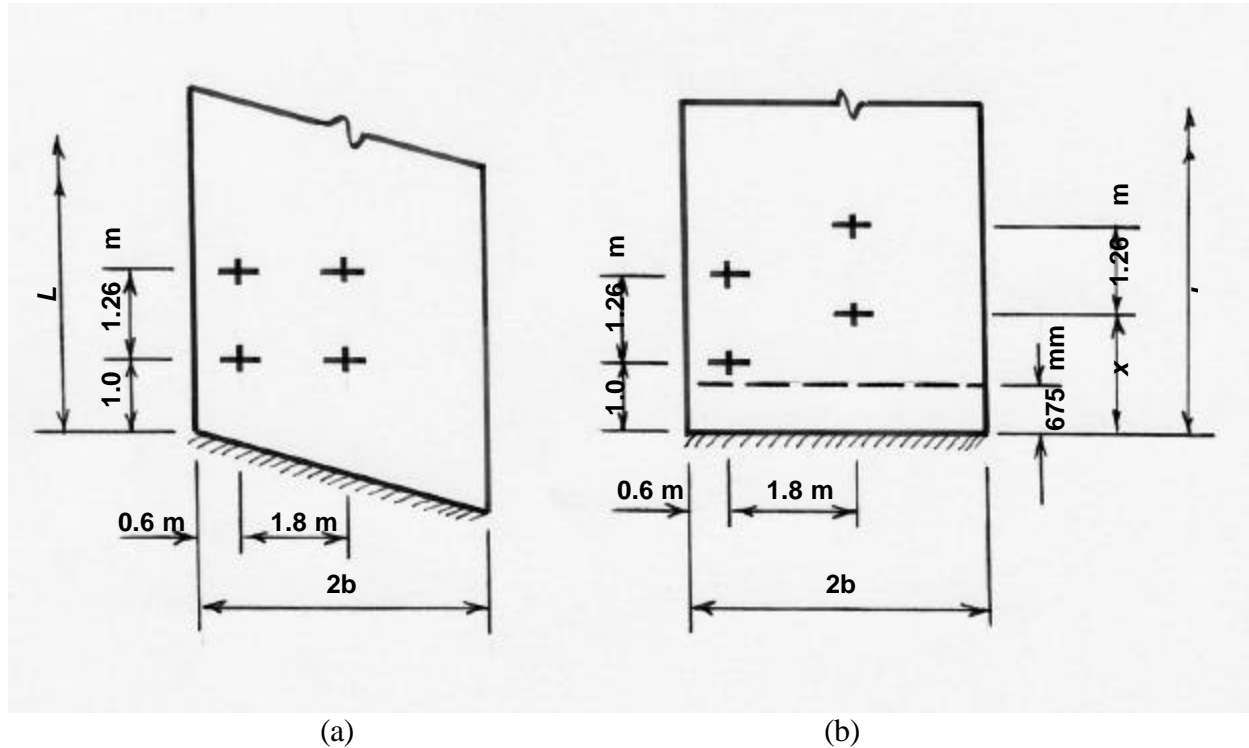

Figure 2 Analysing a skew bridge as right: (a) original skew bridge with orthogonal load pattern; (b) equivalent right bridge with skew load pattern

Each wheel load, represented by a + sign in Figs. 2 (a) and (b) represents a rectangular patch load measuring 300 mm in the longitudinal direction and 600 mm in the transverse direction.

Four skew angles were considered in the analyses. As shown in Fig. 3, these skew angles were  $0^\circ$ ,  $15^\circ$ ,  $30^\circ$  and  $45^\circ$ . Thus for each of the idealised bridges listed in Table 1, four load cases were considered corresponding to each of these skew angles. Since the orthotropic plate program PLATO (Bakht et al., 2002) can handle only similar longitudinal lines of wheels, each load case involved two sets of analyses, one for each line of loads. The results for dissimilar lines of loads (Fig. 2 b) were obtained by summing the results due to the separate lines of wheels.

It is noted that  $L$  in Fig. 3 was 6, 10 and 14 m, and two values of width  $2b$  were considered, these being 4.26 m and 5.50 m.

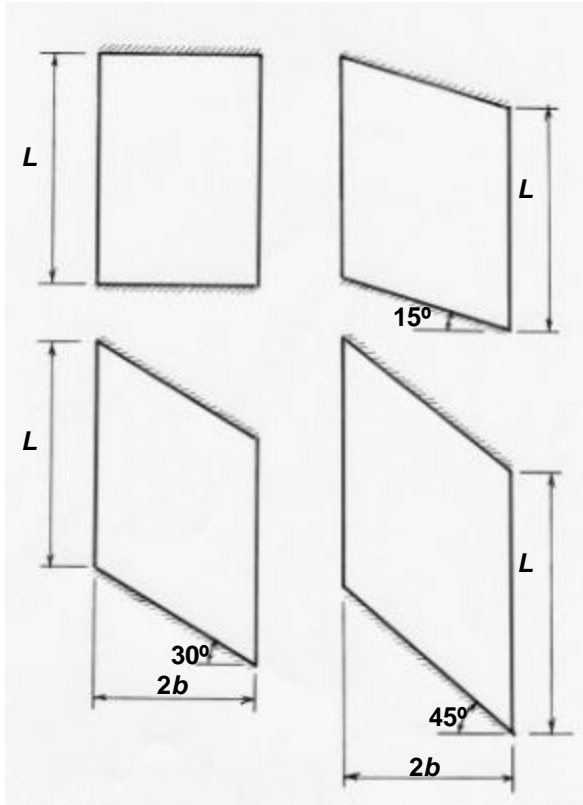

Figure 3 Four skew angles considered in the analyses

#### 4. DETAILS OF ANALYSES

Numerical results of analyses described above are presented in spreadsheet format in Appendix A. For each idealised bridge, the absolute values of longitudinal shear intensity is calculated, in kN/m, for skew angle =  $0^\circ$ ,  $15^\circ$ ,  $30^\circ$  and  $45^\circ$ , respectively. Following the notation of CHBDC Commentary, the magnifier for longitudinal shear is denoted herein as  $C_v$ . The value of  $C_v$  for a bridge with given angle of skew is obtained by dividing the maximum longitudinal shear/plank for the skew bridge with the corresponding value in the right bridge having the same span length, width and relative position of the design truck. From Appendix A, it can be seen that the values of  $C_v$  for nearly all analysed skew bridges are greater than 1.0. The reasons for some values of  $C_v$  being smaller than 1.0 are discussed in the following.

The variation of  $C_v$  with respect to the angle of skew can be studied readily when the results are presented graphically, as in Fig. 4. It can be seen in this figure that  $C_v$  increases most rapidly with increase in the skew angle when the span length is the largest, being 14 m. The increase become less rapid for the smaller span length of 10 m. However, for the smallest span of 6 m, the magnifier rises initially with increase in the angle of skew, but drops just below 1.0 for higher angles of skew. A study of the three  $C_v$ - $\gamma$  angle curves in Fig. 4 shows a systematic change with respect to both the span length and skew angle. This observation confirms that no arithmetical errors were committed in the analyses.

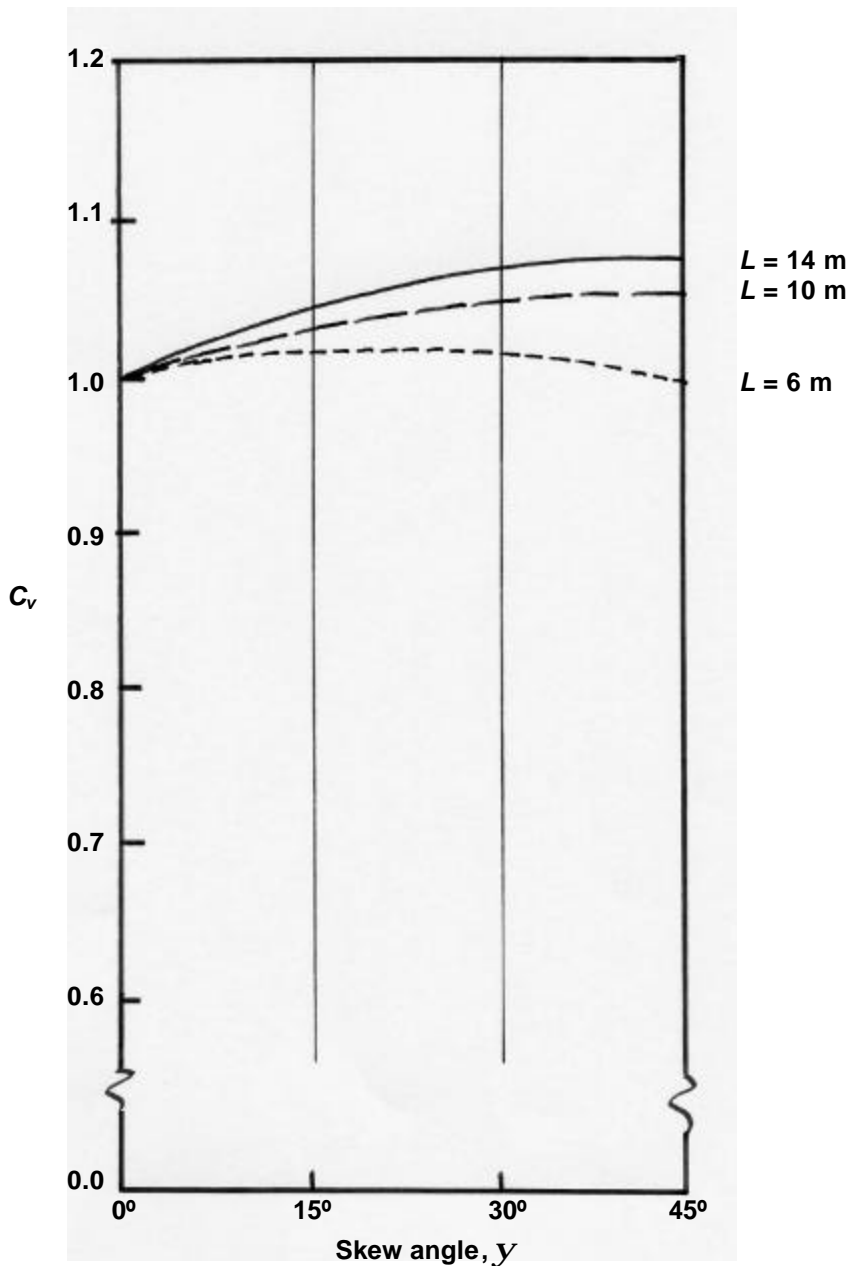

Figure 4  $C_v$  plotted against angle of skew

The values of  $C_v$  for outer and inner planks in some of analysed the shear-connected bridges are listed in Table 2 for both narrow (N) and wide (W) bridges, having widths of 4.26 and 5.50 m, respectively. It can be seen in this table that the magnifier always has a larger value for the outer planks, and that small changes in the bridge width have negligible effect on  $C_v$ .

The results shown in Table 2 clearly show that the effect of bridge width can be neglected in developing the magnifiers. Further, it is also obvious that similar to the simplified method for right bridges, the magnifiers need be developed only for the outer planks.

Table 2 Values of  $C_v$  for some cases

Bridge	$C_v$ for outer planks for skew angle =				$C_v$ for inner planks for skew angle =			
	0°	15°	30°	45°	0°	15°	30°	45°
6N	1.000	1.013	1.015	0.998	1.000	1.018	1.018	0.990
6W	1.000	1.017	1.016	0.989	1.000	1.021	1.016	0.973
14N	1.000	1.039	1.065	1.076	1.000	1.047	1.076	1.084
14W	1.000	1.034	1.052	1.052	1.000	-	-	-

While the trends of three  $C_v$ - $\gamma$  curves are well defined, it can be seen that the maximum value of the magnifier is nearly 1.08. An 8% increase in the maximum longitudinal shear intensity is very small and can be neglected. The 3<sup>rd</sup> edition of the Ontario Highway Bridge Design Code (OHBD, 1991), the predecessor of the CHBDC (2000), specified that the simplified analysis for live loads could be applied to a skew slab-on-girder bridge provided that the value of the skew parameter, defined by Equation [1], is less than 1/18. The commentary to the OHBD (1991) states that this limit ensures that the shear values obtained by the simplified method are not in unsafe error by more than 5%.

Since an unsafe error of up to 5% is considered acceptable by a state-of-the-art bridge design code, a case can also be made for increasing this limit to 8%. It is noted that, as explained later, only a few bridges will have an unsafe error of more than 5%.

The curves drawn in Fig. 4 have a relatively small vertical scale, making it difficult to visualise minute variations. In order to study them microscopically, the curves are redrawn in Fig. 5 with an exaggerated vertical scale, in which each division represents a 0.01 step in  $C_v$ .

It can be seen from Fig. 5 that  $C_v$  is larger than 1.05 only for large span bridges having skew angles greater than about 20°. For all other skew bridges, the degree of unsafe error in analysing them as right bridges will be 5% or smaller. Notwithstanding this observation, a simplified method is now developed so that no theoretical error is involved in the simplified method.

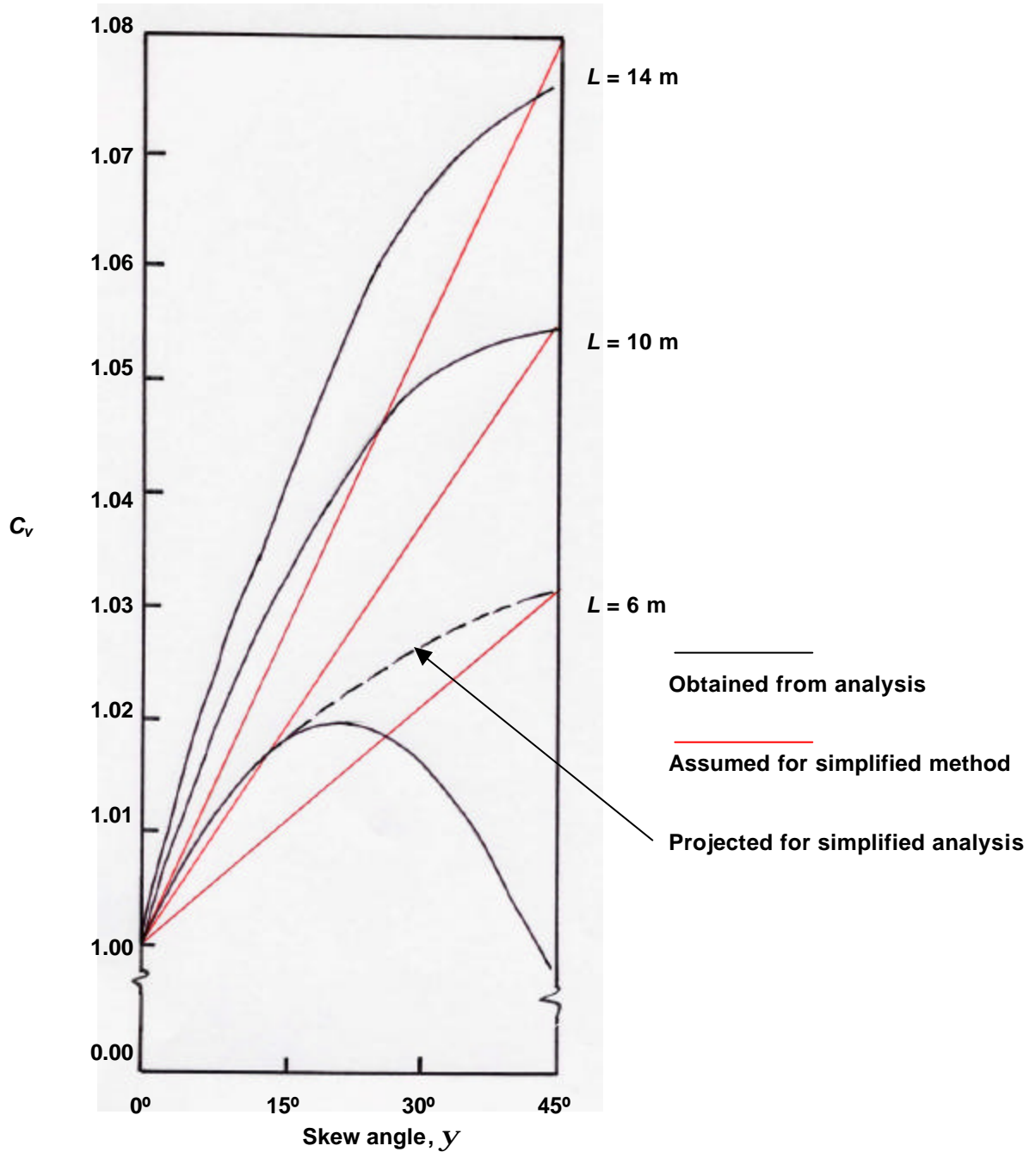

Figure 5  $C_v$  plotted against angle of skew with an exaggerated scale for  $C_v$

## 5. PROPOSED METHOD

In the interest of keeping the simplified method really *simple* three simplifying assumptions are made regarding the  $C_v$ - $\gamma$  curves, two of which are illustrated in Fig. 5: (a)  $C_v$  varies linearly with respect to the angle of skew; (b) for  $L = 6$  m,  $C_v$  does not drop with increase in the skew angle,



but keeps rising as shown in Fig. 5; and (c)  $C_v$  varies linearly with span length. As shown later, these assumptions lead to miniscule errors. By adopting these assumptions, the curves of Fig. 5 can be represented by the following equation.

$$[3] \quad C_e = 1 + \frac{Ly}{8000}$$

where the span length  $L$  is in metres and skew angle  $y$  is in degrees. The application of the magnifier  $C_v$  is quite simple: Obtain the maximum intensity of longitudinal shears by the simplified method proposed by Bakht (2004), and multiply this intensity by  $C_v$  obtained from Equation [3].

## 6. ACCURACY OF PROPOSED METHOD

The values of  $C_v$  obtained from rigorous analysis (Appendix A) are compared in Table 3 with those obtained from Equation [3].

Table 3 Comparison of values of  $C_v$  obtained from rigorous analysis and Equation [3]

$L, m$	Method	$C_v$ for skew angle =		
		15°	30°	45°
14.0	Rigorous	1.03	1.07	1.08
	Equation [3]	1.03	1.05	1.08
10.0	Rigorous	1.03	1.05	1.05
	Equation [3]	1.02	1.04	1.06
6.0	Rigorous	1.02	1.02	1.00
	Equation [3]	1.01	1.02	1.03

It can be seen in Table 3 that the differences in values of  $C_v$  given by rigorous analysis and obtained by Equation [3] are less than 0.01 in all cases except one, in which the difference is 0.03 on the safe side. It is thus concluded that the proposed method, although based on simplifying assumptions, is fairly accurate.

## 7. CONCLUSIONS

A simplified method has been developed for skew shear-connected bridges with one design lane to correct the design values of longitudinal shear obtained by the simplified method proposed by Bakht (2004). Similar to the method specified in the Commentary to the CHBDC (2001), the proposed method utilises a multiplier, always greater than 1.0, that depends upon the span length and angle of skew (Equation 1). It has been shown that the maximum unsafe error involved in predicting the design values of longitudinal shear in the bridges under consideration is likely to be under 8%. If this degree of error is deemed to be acceptable, then the effect of skew angle need not be considered.

## 8. REFERENCES

Bakht, B. 2004. Simplified analysis of single-span shear-connected plank bridges. Report prepared for British Columbia Ministry of Forests, May.

Bakht, B. 1988. Analysis of Skew Bridges as Right Bridges. ASCE Journal of Structural Engineering, Vol.114, No.10, pp.2307-2322.

Bakht, B., Mufti, A.A., and Desai, Y.M. 2002. PLATO User Manual, ISIS Canada, University of Manitoba.

CHBDC. 2000. Canadian Highway Bridge Design Code CAN/CSA-S6-00. CSA International, Toronto.

Commentary. 2001. S6.1-00, Commentary on CAN/CSA-S6-00, Canadian Highway Bridge Design Code. CSA International, Toronto.

Jaeger, L.G., and Bakht, B. 1989. Bridge Analysis by Microcomputer. McGraw Hill, New York.

Jaeger, L.G., and Bakht, B., and Surana C. 1988. Application of Analysis of Three-Girder Skew Bridges. Proceedings of the Second International Colloquium on Concrete in Developing Countries, January, Bombay, India, Section 5, pp.52-66.

OHBDC. 1991. Ontario Highway Bridge Design Code, Ministry of Transportation of Ontario, Downsview, Ontario.

Commentary to OHBDC. 1991. Ontario Highway Bridge Design Code, Ministry of Transportation of Ontario, Downsview, Ontario.