



PROVINCE OF BRITISH COLUMBIA



Ministry of Forests

**TREE FARM LICENCE NO. 56
GOLDSTREAM TREE FARM LICENCE
(The "Licence")**

THIS LICENCE, dated January 1, 1999

BETWEEN:

**THE MINISTER OF FORESTS, on behalf of
HER MAJESTY THE QUEEN IN RIGHT
OF THE PROVINCE OF BRITISH COLUMBIA
(the "Minister")**

**AND: REVELSTOKE COMMUNITY FOREST CORPORATION
P.O. BOX 3199
REVELSTOKE, BRITISH COLUMBIA
V0E 2S0
(the "Licensee")**

WHEREAS:

- A. Under Section 36 of the *Forest Act*, the minister offered a replacement licence to the Licensee.
- B. The Licensee has accepted the offer.
- C. The Licensee has agreed to manage the Licence Area according to this Licence and the Management Plan in effect under this Licence.

THEREFORE:

Under Section 36 of the *Forest Act*, this Licence replaces Tree Farm Licence No. 56, dated January 1, 1994.

TABLE OF CONTENTS

"The Table of Contents and headings in this Licence are included for convenience only and do not form a part of this Licence and in no way define, limit, alter or enlarge the scope or meaning of any provision of this Licence."

	<u>Page</u>
WHEREAS:.....	1
TABLE OF CONTENTS	2
1.00 <u>GRANT OF RIGHTS AND TERM</u>	3
2.00 <u>MANAGEMENT PLANS</u>	7
MANAGEMENT PLAN REVIEW	7
TIMBER SUPPLY ANALYSIS INFORMATION PACKAGE	8
DRAFT MANAGEMENT PLAN.....	10
20-YEAR PLAN	14
TIMBER SUPPLY ANALYSIS	15
PROPOSED MANAGEMENT PLAN	16
MISCELLANEOUS.....	21
3.00 <u>CONDITIONS IMPOSED UPON ACCEPTANCE OR APPROVAL</u>	23
4.00 <u>FELLING, BUCKING AND UTILIZATION SPECIFICATIONS</u>	24
5.00 <u>RESIDUE AND WASTE ASSESSMENTS</u>	25
6.00 <u>CUT CONTROL</u>	27
7.00 <u>CRUISE AND APPRAISAL INFORMATION</u>	27
8.00 <u>CUTTING PERMITS</u>	27
9.00 <u>LEGISLATIVE FRAMEWORK</u>	30
10.00 <u>ABORIGINAL RIGHTS AND/OR TITLE</u>	30
11.00 <u>REPORTING</u>	32
12.00 <u>FINANCIAL AND DEPOSITS</u>	33
13.00 <u>ACCESS AND ACCOMMODATION</u>	37
14.00 <u>CONTRACTORS</u>	38
15.00 <u>TIMBER PROCESSING</u>	39
16.00 <u>LIABILITY AND INDEMNITY</u>	40
17.00 <u>LIMITATION OF LIABILITY</u>	41
18.00 <u>TERMINATION</u>	41
19.00 <u>NOTICE</u>	42
20.00 <u>MISCELLANEOUS</u>	42
21.00 <u>INTERPRETATION & DEFINITIONS</u>	44
SCHEDULE A..... 1 PAGE	
SCHEDULE B..... 4 PAGES	
SCHEDULE C..... 5 PAGES	
SCHEDULE D..... 23 PAGES	
TFL MAPS IN FOLDER1	

THE PARTIES agree as follows:

1.00 GRANT OF RIGHTS AND TERM

- 1.01 The term of this Licence is 25 years, beginning January 1, 1999.
- 1.02 Subject to this Licence, the Minister grants the Licensee
- (a) the exclusive right during the term of this Licence to harvest from
 - (i) Schedule B Land, and
 - (ii) Schedule A Land subject to a timber licence,timber of the types specified in paragraph 1.03 from the types of terrain specified in paragraph 1.04,
 - (b) the right to manage
 - (i) Schedule B Land, and
 - (ii) Schedule A Land subject to a timber licence,according to this Licence, the management plan in effect under this Licence, and operational plans approved in respect of this Licence, and
 - (c) the right to enter and use
 - (i) Schedule B Land, and
 - (ii) Schedule A Land subject to a timber licence,for the purpose of exercising a right or fulfilling an obligation under this Licence.
- 1.03 The following types of timber are specified for the purposes of paragraph 1.02:
- (a) on Schedule A Land subject to a timber licence, all merchantable timber; and
 - (b) on Schedule B Land, all types of timber other than deciduous types.
- 1.04 The following types of terrain are specified for the purposes of paragraph 1.02:
- (a) on Schedule A Land subject to a timber licence, all terrain containing merchantable timber; and
 - (b) on Schedule B Land, all types of terrain.
- 1.05 Subject to this Licence, the Licensee may also harvest timber from the Licence Area that is not
- (a) of a type specified in paragraph 1.03, or
 - (b) from a type of terrain specified in paragraph 1.04.

- 1.06 The Licensee will not harvest timber from the Licence Area except under a cutting permit or road permit, or a free use permit issued to the Licensee and as otherwise authorized under the Acts and regulations referred to in paragraph 9.01.
- 1.07 Subject to paragraph 1.08, the Licensee will not occupy Schedule B Land or Schedule A Land subject to a timber licence, except under and in accordance with a cutting permit, road permit, or special use permit authorizing such use or occupation.
- 1.08 Paragraph 1.07 does not apply to temporary occupation for the purpose of
- (a) carrying out silviculture,
 - (b) collecting inventory information,
 - (c) doing engineering layouts and surveys,
 - (d) carrying out protection and forest health activities, and
 - (e) fulfilling other obligations of the Licensee under or associated with this Licence.
- 1.09 Each year during the term of this Licence, the Regional Manager or District Manager may dispose of the following volumes of timber of a type specified in paragraph 1.03 from a type of terrain specified in paragraph 1.04, provided the timber is within areas of Schedule B Land agreed under paragraph 1.12 or specified under paragraph 1.13:
- (a) subject to paragraph 1.17, 11 480 m³ of the allowable annual cut, under non-replaceable timber sale licences; and
 - (b) a volume of timber not exceeding one half of one percent (0.5%) of the portion of the allowable annual cut the Chief Forester determines is attributable to Schedule B Land, under free use permits.
- 1.10 In addition to any timber disposed of under paragraph 1.09, each year during the term of this Licence, the Regional Manager or District Manager may dispose of timber of a type other than that specified in paragraph 1.03 from a type of terrain specified in paragraph 1.04, under timber sale licences issued pursuant to a pulpwood agreement, provided
- (a) the timber is
 - (i) of the type referred to in Section 40(1)(b) of the *Forest Act*,
 - (ii) within a pulpwood area designated by the Minister, and
 - (iii) within areas of Schedule B Land agreed to under paragraph 1.12 or specified under paragraph 1.13, and

- (b) the volume of timber disposed of does not exceed an amount equal to the portion of the allowable annual cut which the Chief Forester determines is attributable to timber of the type referred to in clause(a)(i), having regard to the factors and information considered by the Chief Forester in his or her most recent determination of the allowable annual cut.

1.11 In addition to any timber disposed of under paragraphs 1.09 and 1.10, the Regional Manager or District Manager may dispose of any timber in the Licence Area that is not

- (a) of a type specified in paragraph 1.03,
- (b) from a type of terrain specified in paragraph 1.04,

provided the timber is within areas of Schedule B Land agreed to under paragraph 1.12 or specified under paragraph 1.13.

1.12 Subject to paragraph 1.13, the District Manager and the Licensee will agree upon areas of Schedule B Land for the purposes of paragraphs 1.09, 1.10, 1.11 and 1.18, having regard to

- (a) the type and quality of timber on the area of Schedule B Land under consideration compared to the Schedule B Land as a whole,
- (b) the type of terrain on the area of Schedule B Land under consideration compared to the Schedule B Land as a whole,
- (c) in the case of paragraph 1.10, the type of timber referred to in Section 40(1)(b) of the *Forest Act*,
- (d) in the case of paragraph 1.18, the nature of the Licensee's failure to comply with the management plan,
- (e) the management plan in effect under this Licence and the forest development plan approved in respect of this Licence,
- (f) any potential interference with the operations of the Licensee under this Licence, and
- (g) use of the Licence Area for purposes other than timber production, including use of the Licence Area by
 - (i) trappers, guide outfitters, range tenure holders, and other licensed resource users, and
 - (ii) aboriginal people claiming an aboriginal interest in or to the area.

- 1.13 If under paragraph 1.12 the District Manager and the Licensee are unable to agree upon areas of Schedule B Land for the purposes of paragraphs 1.09, 1.10, 1.11 or 1.18, the District Manager or the Licensee may refer the matter to the Regional Manager, in which case the Regional Manager, subject to paragraph 1.16, and having regard to
- (a) the factors referred to in paragraph 1.12, and
 - (b) the recommendations of the District Manager and the Licensee,
- will specify areas for these purposes.
- 1.14 Subject to paragraphs 1.15 and 1.16, the Minister in a notice given to the Licensee may delete an area from Schedule B Land to enable the Regional Manager or District Manager to issue a woodlot licence over the area, if the Chief Forester determines that the portion of the allowable annual cut attributable to the area does not exceed the volume of timber referred to in subparagraph 1.09(a), having regard to the factors and information considered by the Chief Forester in his or her most recent determination of the allowable annual cut.
- 1.15 Before deleting an area under paragraph 1.14, the Minister will consult the Licensee and consider any recommendations made by the Licensee.
- 1.16 The Regional Manager will only specify an area under paragraph 1.13, and the Minister will only delete an area under paragraph 1.14, where the Regional Manager or the Minister, as the case may be, is satisfied that specifying or deleting the area will not
- (a) compromise the management plan in effect under this Licence or a forest development plan approved in respect of this Licence, or
 - (b) unreasonably interfere with the Licensee's operations under this Licence.
- 1.17 Where the Minister deletes an area under paragraph 1.14, the volume of timber referred to in subparagraph 1.09(a) is deemed to be reduced by an amount equal to the portion of the allowable annual cut that the Chief Forester determines is attributable to the deleted area, having regard to the factors and information considered by the Chief Forester in his or her most recent determination of the allowable annual cut.
- 1.18 If
- (a) a management plan referred to in paragraph 2.01 or approved under paragraph 2.28 provides that part of the allowable annual cut is to be harvested from a specified part of the Licence Area or from a specified type of timber or terrain, and the Licensee fails to comply with that provision, and

- (b) as a consequence, the Chief Forester, under Section 69 of the *Forest Act*, reduces the portion of the allowable annual cut available to the Licensee,

then, in addition to any timber disposed of under paragraphs 1.09, 1.10, and 1.11, the Regional Manager or District Manager may dispose of a volume of timber, from areas of Schedule B Land agreed to under paragraph 1.12 or specified under paragraph 1.13, up to an amount equal to the amount by which the Chief Forester reduces the allowable annual cut under Section 69 of the *Forest Act* multiplied by the number of years the reduction remains in effect.

- 1.19 If an area of Schedule A Land is
 - (a) subject to a timber licence that expires, or
 - (b) deleted from a timber licence,

then the area is deemed to be deleted from Schedule A Land and added to Schedule B Land.

2.00 MANAGEMENT PLANS

- 2.01 A management plan
 - (a) approved under the tree farm licence replaced by this Licence, and
 - (b) still in effect on the date immediately preceding the date referred to in paragraph 1.01;

is deemed for the remainder of the term of the management plan to be the management plan in effect under this Licence.

- 2.02 If the management plan referred to in paragraph 2.01 expires before June 30, 2002, then for the purpose of preparing and submitting the components necessary for the approval of a new management plan,
 - (a) the Licensee will follow the 30-month process described in Schedule D, and
 - (b) paragraphs 2.03 to 2.44 of this Licence will not apply.

MANAGEMENT PLAN REVIEW

- 2.03 Not less than 20 months prior to the date on which the management plan in effect under this Licence is due to expire,
 - (a) the Regional Manager will provide the Licensee with a review
 - (i) of the management plan in effect under this Licence,

- (ii) the Licensee's performance in respect of that management plan, and
- (b) a list of guidelines currently in effect, and
- (c) the Regional Manager may specify the location(s) and time designated for the draft management plan public review.

TIMBER SUPPLY ANALYSIS INFORMATION PACKAGE

- 2.04 Not less than 16 months prior to the date on which the management plan in effect under this licence is due to expire, the Licensee will submit a Timber Supply Analysis Information Package to the Timber Supply Forester.
- 2.05 A Timber Supply Analysis Information Package submitted under paragraph 2.04 or subparagraph 2.07(b) must
 - (a) include the information required in the applicable manual in effect six months prior to the deadline for submitting the Timber Supply Analysis Information Package,
 - (b) identify assumptions the Licensee proposes to incorporate into the timber supply analysis referred to in paragraph 2.22 which are consistent with
 - (i) this Licence,
 - (ii) the Acts, regulations and standards referred to in paragraph 9.01,
 - (iii) higher level plans, and
 - (iv) subject to paragraph 2.40, the guidelines referred to in paragraph 2.03.(b),
 - (c) without restricting the generality of subparagraph (b), identify assumptions the Licensee proposes to incorporate into the timber supply analysis referred to in paragraph 2.22 regarding
 - (i) the inventory of timber and non-timber resources in the Licence Area,
 - (ii) growth and yield,
 - (iii) regeneration delays,
 - (iv) silviculture treatments,
 - (v) integrated resource management constraints,
 - (vi) harvesting methods and felling, bucking and utilization specifications, and
 - (vii) the timber harvesting land base,

- (d) describe the methodology, including the computer model, if any, that the Licensee proposes to use in the timber supply analysis, including a description of the extent to which the assumptions referred to in subparagraphs (b) and (c) are reflected in the methodology,
- (e) include information which supports the assumptions referred to in subparagraphs (b), (c) and (d),
- (f) describe how the Licensee proposes to address in the timber supply analysis, any inadequacies referred to in the draft management plan submitted under subparagraph 2.09(d), and
- (g) include any other information readily available to the Licensee, which
 - (i) the Licensee, or
 - (ii) the Timber Supply Forester, in a notice given to the Licensee 18 months prior to the date on which the management plan in effect under this licence is due to expire ,

considers relevant to an assessment of the timber supply of the Licence area.

2.06 Where the Timber Supply Forester accepts both the assumptions and the methodology referred to in paragraph 2.05 or subparagraph 2.07(b),

- (a) the Timber Supply Forester, within three months after the date on which the Timber Supply Analysis Information Package is submitted under paragraph 2.04, or one month after the information or proposals submitted under subparagraph 2.07(b), will in a notice given to the Licensee accept the assumptions and the methodology referred to in paragraph 2.05 and, if applicable, subparagraph 2.07(b) for use in the timber supply analysis referred to in paragraph 2.22 subject to such conditions as the Timber Supply Forester considers necessary or appropriate, if
 - (i) the requirements of paragraph 2.05 and, if applicable, subparagraph 2.07(b) have been met, and
 - (ii) the Timber Supply Forester is satisfied with the information provided in support of the assumptions and methodology.

2.07 Where the Timber Supply Forester does not accept both the assumptions and the methodology under paragraph 2.06,

- (a) the Timber Supply Forester, within three months after the date on which the Timber Supply Forester receives the Timber Supply Analysis Information Package submitted under paragraph 2.04, or one month after the date on which the Timber Supply Forester receives the information or proposals submitted under subparagraph (b), will specify in a notice given to the Licensee why the Timber Supply Forester has not accepted the assumptions, the methodology or both, and
- (b) the Licensee, within two months after the date on which the Licensee is given the notice referred to in subparagraph (a), will
 - (i) propose new or revised assumptions,
 - (ii) propose a new or revised methodology, and
 - (iii) submit further information in support of the assumptions, the methodology or both,as required by the Timber Supply Forester.

DRAFT MANAGEMENT PLAN

- 2.08 Not less than 16 months prior to the date on which the management plan in effect under this Licence is due to expire, the Licensee will submit a draft management plan to the Regional Manager for comment.
- 2.09 A draft management plan referred to in paragraph 2.08 or subparagraph 2.41(a) must
 - (a) be prepared by a professional forester in accordance with the manual in effect four months prior to the deadline for submitting the draft management plan under paragraph 2.08 or subparagraph 2.41(a),
 - (b) be consistent with
 - (i) this Licence,
 - (ii) the Acts, regulations and standards referred to in paragraph 9.01,
 - (iii) higher level plans,
 - (iv) subject to paragraph 2.37, the guidelines referred to in subparagraph 2.03(b),and take into consideration the Regional Manager's review under paragraph 2.03,
 - (c) include inventories, prepared in the manner, presented in the format and meeting the specifications set or approved in the applicable manual in effect six months prior to the deadline for submitting the Timber Supply Analysis Information Package, of

- (i) the forest and recreation resources in the Licence Area, based on information collected for this purpose by the Licensee, including information relating to visual quality objectives, sensitive soils, recreation sites, and the type of timber and terrain, and
 - (ii) the fisheries, wildlife, range, and cultural heritage resources of the Licence Area, based on the best information readily available to the Licensee,
- (d) include proposals for updating the inventories referred to in subparagraph (c) and, if applicable, addressing inadequacies in the inventory information,
- (e) propose management objectives regarding
- (i) management and utilization of the timber resources in the Licence Area, including harvesting methods and felling, bucking and utilization specifications suitable to the types of timber and terrain specified in paragraphs 1.03 and 1.04,
 - (ii) protection and conservation of the non-timber values and resources in the Licence Area, including visual quality, biological diversity, soils, water, recreation resources, cultural heritage resources, range land, and wildlife and fish habitats,
 - (iii) integration of harvesting activities in the Licence Area with use of the Licence Area for purposes other than timber production, including use of the Licence Area by
 - (A) trappers, guide outfitters, range tenure holders, and other licensed resource users, and
 - (B) aboriginal people claiming an aboriginal interest in or to the area,
 - (iv) forest fire prevention and suppression, prescribed fire, and fuel management,
 - (v) forest health, including disease and pest management,
 - (vi) silviculture, and
 - (vii) road construction, maintenance and deactivation,
- (f) include proposals for meeting the proposed management objectives referred to in subparagraph (e), including measures to be taken and specifications to be followed by the Licensee which meet or, if the Licensee so chooses, exceeds any requirements of the Acts, regulations and standards referred to in paragraph 9.01, or of the higher level plans, or guidelines referred to in subparagraph (b),
- (g) specify measures to be taken by the Licensee to identify and consult with persons using the Licence Area for purposes other than timber production, including

- (i) trappers, guide outfitters, range tenure holders, and other licensed resource users, and
 - (ii) aboriginal people claiming an aboriginal interest in or to the area,
- (h) assess the impact the draft management plan may have on factors such as harvest levels, economic opportunities, the number of persons employed by the Licensee and contractors of the Licensee, and the protection and conservation of non-timber values,
- (i) highlight the key similarities and differences between the draft management plan and the management plan in effect or last in effect under this Licence, and in a summary form compare
- (i) the impact, if any, that implementation of the management plan in effect or last in effect under this Licence had, and
 - (ii) the impact, if any, that the Licensee anticipates implementation of the draft management plan will have on factors such as those referred to in subparagraph (h),
- (j) if applicable, provide that part of the allowable annual cut will be harvested from a specified part of the Licence Area, or from a specified type of timber or terrain,
- (k) include any other information on the development, management and use of the Licence Area that the Chief Forester requires, and
- (l) if required in the manual referred to in subparagraph (a), provide some or all of the information referred to in this paragraph in the form of maps meeting the requirements of the manual.

2.10 At substantially the same time or at a time otherwise agreed to between the Regional Manager and the Licensee, the Licensee must publish, at least twice within a period of two consecutive weeks, a notice in a newspaper(s) circulating near the area of the Licence stating that the draft management plan is available for public review and comment.

2.11 The Licensee must provide an opportunity to review the draft management plan to members of the public interested in or affected by operations under the Licence

- (a) at a location and time, if specified by the Regional Manager in the management plan review referred to in subparagraph 2.03(b),
- (b) at another location proposed by the Licensee and approved by the Regional Manager, or
- (c) at the Licensee's place of business nearest to the Licence Area.

- 2.12 The public review referred to in paragraph 2.11 must provide an opportunity for comment to members of the public interested in or affected by operations under this Licence, including but not restricted to
- (i) resource agencies,
 - (ii) trappers, guide outfitters, range tenure holders, and other licensed resource users,
 - (iii) aboriginal people,
 - (iv) local governments, and
 - (v) members of the public.
- 2.13 Subject to paragraph 2.14, the opportunity for a review provided under paragraph 2.11 must be for a period of 60 days from the date of the publication of the first notice under paragraph 2.10.
- 2.14 The period of review specified under paragraph 2.13 may be
- (a) any lesser period as mutually agreed upon between the Licensee and the Regional Manager,
 - (b) extended by the Licensee on providing written notice to the Regional Manager, and
 - (c) extended by the Regional Manager on giving at least ten days notice to the Licensee prior to the expiry of the review period.
- 2.15 An opportunity for comment provided to a person referred to in paragraph 2.12 will be adequate only if, in the opinion of the Regional Manager, the opportunity is commensurate with the nature and extent of that person's interest in the Licence Area and any right that person may have to use the Licence Area.
- 2.16 The Regional Manager, within three months after the date on which the Regional Manager receives the draft management plan submitted under paragraph 2.08, will provide the Licensee with written comments on the draft management plan which the Licensee must consider in the development of the timber supply analysis, twenty year plan, and proposed management plan.
- 2.17 The Licensee not less than 12 months prior to the date on which the management plan in effect under this Licence is due to expire must consider all comments received during the period for review under paragraph 2.13, and will submit to the Regional Manager
- (a) a copy of the notice that was published under paragraph 2.10 in respect of the draft management plan, and
 - (b) a copy of each comment received by the Licensee in respect of the draft management plan, and

- (c) proposals, if any, to address the comments referred to in subparagraphs 2.12 and 2.16, in the proposed management plan, timber supply analysis and 20-year plan.

20-YEAR PLAN

- 2.18 Where the Timber Supply Forester accepts the assumptions and the methodology under paragraph 2.06, the Licensee, not less than 10 months prior to the date on which the management plan in effect under this licence is due to expire, will submit a 20-year plan to the District Manager.
- 2.19 A 20-year plan submitted under paragraph 2.18 or subparagraph 2.21(b) must
 - (a) identify
 - (i) the timber harvesting land base,
 - (ii) harvested areas,
 - (iii) existing and proposed road access within the net timber harvesting land base, and
 - (iv) areas subject to special integrated resource management constraints, such as use of the Licence Area for purposes other than timber production,
 - (b) categorize areas within the timber harvesting land base referred to in clause (a)(i) by
 - (i) the type and quality of timber, and
 - (ii) the harvesting methods suitable to the terrain, and
 - (c) in support of the timber supply analysis, set out a hypothetical sequence of cut blocks in 5 year increments over a period of 20 years, or longer if the Licensee so chooses, which is consistent with
 - (i) this Licence,
 - (ii) the Acts, regulations and standards referred to in paragraph 9.01,
 - (iii) higher level plans, and
 - (iv) subject to paragraph 2.37, the guidelines referred to in subparagraph 2.03(b)
- 2.20 Where the District Manager accepts a 20-year plan referred to under paragraph 2.18 or subparagraph 2.21(b),

- (a) the District Manager, within three months after the date on which the 20-year plan is submitted under paragraph 2.18, or one month after the date the 20-year plan is submitted under subparagraph 2.21(b), will in a notice to the Licensee accept the 20-year plan, subject to such conditions as considered necessary or appropriate, and
 - (b) where the District Manager accepts the 20-year plan under subparagraph (a), provide the Licensee with an assessment of the strengths and weaknesses of the 20-year plan.
- 2.21 Where the District Manager does not accept a 20-year plan under paragraph 2.20,
 - (a) the District Manager, within three months after the date on which the District Manager receives a 20-year plan submitted under paragraph 2.18, or one month after the date on which the District Manager receives a 20-year plan submitted under subparagraph (b), will specify in a notice given to the Licensee why the District Manager has not accepted the 20-year plan, and
 - (b) the Licensee, within one month after the date on which the Licensee is given the notice referred to in subparagraph (a), will submit a new or revised 20-year plan to the District Manager.

TIMBER SUPPLY ANALYSIS

- 2.22 Where the Timber Supply Forester accepts the assumptions and the methodology under paragraph 2.06, the Licensee, not less than 10 months prior to the date on which the management plan in effect under this licence is due to expire, will submit a timber supply analysis to the Timber Supply Forester.
- 2.23 A timber supply analysis submitted under paragraph 2.22 or subparagraph 2.25(b) must be based on the assumptions, and use the methodology, accepted by the Timber Supply Forester under paragraph 2.06.
- 2.24 Where the Timber Supply Forester accepts a timber supply analysis under paragraph 2.22 or subparagraph 2.25(b),
 - (a) the Timber Supply Forester, within three months after the date on which the timber supply analysis is submitted under paragraph 2.22, or one month after the date the timber supply analysis is submitted under subparagraph 2.25(b), will in a notice given to the Licensee accept the timber supply analysis, and

(b) where the Timber Supply Forester accepts the timber supply analysis under subparagraph (a), provide the Licensee with an assessment of the strengths and weaknesses of the timber supply analysis.

2.25 Where the Timber Supply Forester does not accept a timber supply analysis under paragraph 2.24,

(a) the Timber Supply Forester, within three months after the date on which the Timber Supply Forester receives a timber supply analysis submitted under paragraph 2.22, or one month after the date on which the Timber Supply Forester receives a timber supply analysis submitted under subparagraph (b), will specify in a notice given to the Licensee why the Timber Supply Forester has not accepted the timber supply analysis, and

(b) the Licensee, within one month after the date on which the Licensee is given the notice referred to in subparagraph (a), will submit a new or revised timber supply analysis to the Timber Supply Forester.

PROPOSED MANAGEMENT PLAN

2.26 The Licensee, not less than four months prior to the date on which the management plan in effect under this Licence is due to expire, will submit to the Chief Forester and Regional Manager

(a) a proposed management plan which is based on the draft management plan referred to in paragraph 2.08, and

(b) incorporates the Licensee's proposals, if any, to address the comments received from the review of the draft management plan as specified in paragraph 2.17

2.27 A proposed management plan submitted by the Licensee under paragraph 2.26, subparagraph 2.31(b) or 2.41(b) must

(a) be prepared by a professional forester in accordance with the manual in effect four months prior to the deadline for submitting the draft management plan under paragraph 2.08 or 2.41(a), as the case may be,

(b) be signed and sealed by a professional forester, and signed by the Licensee or an authorized signatory of the Licensee,

(c) be consistent with

(i) this Licence,

(ii) the Act, regulations and standards referred to in paragraph 9.01,

- (iii) higher level plans, and
- (iv) subject to paragraph 2.37, the guidelines referred to in subparagraph 2.03(b),

and take into consideration the Regional Manager's review under paragraph 2.03,

- (d) include inventories, prepared in the manner, presented in the format and meeting the specifications set or approved in the applicable manual in effect six months prior to the deadline for submitting the Timber Supply Analysis Information Package, of
 - (i) the forest and recreation resources in the Licence Area, based on information collected for this purpose by the Licensee, including information relating to visual quality objectives, sensitive soils, recreation sites, and the type of timber and terrain, and
 - (ii) the fisheries, wildlife, range, and cultural heritage resources of the Licence Area, based on the best information readily available to the Licensee,
- (e) include proposals for updating the inventories referred to in subparagraph (d) and, if applicable, addressing inadequacies in the inventory information,
- (f) propose management objectives regarding
 - (i) management and utilization of the timber resources in the Licence Area, including harvesting methods and felling, bucking and utilization specifications suitable to the types of timber and terrain specified in paragraphs 1.03 and 1.04,
 - (ii) protection and conservation of the non-timber values and resources in the Licence Area, including visual quality, biological diversity, soils, water, recreation resources, cultural heritage resources, range land, and wildlife and fish habitats,
 - (iii) integration of harvesting activities in the Licence Area with use of the Licence Area for purposes other than timber production, including use of the Licence Area by
 - (A) trappers, guide outfitters, range tenure holders, and other licensed resource users, and
 - (B) aboriginal people claiming an aboriginal interest in or to the area ,
 - (iv) forest fire prevention and suppression, prescribed fire, and fuel management,
 - (v) forest health, including disease and pest management,
 - (vi) silviculture,

- (vii) road construction, maintenance and deactivation, and
- (g) include proposals for meeting the proposed management objectives referred to in subparagraph (f), including measures to be taken and specifications to be followed by the Licensee which meet or, if the Licensee so chooses, exceeds any requirements of the Acts, regulations and standards referred to in paragraph 9.01, or of the higher level plans or guidelines referred to in subparagraph (c),
- (h) specify measures to be taken by the Licensee to identify and consult with persons using the Licence Area for purposes other than timber production, including
 - (i) trappers, guide outfitters, range tenure holders, and other licensed resource users, and
 - (ii) aboriginal people claiming an aboriginal interest in or to the area,
- (i) include
 - (i) the timber supply analysis accepted under paragraph 2.24, together with the assessment referred to in subparagraph 2.24(b), and
 - (ii) the 20-year plan accepted under paragraph 2.20, together with the assessment referred to in paragraph 2.20(b), or
- (j) assess the impact the proposed management plan will have on factors such as harvest levels, economic opportunities, the number of persons employed by the Licensee and contractors of the Licensee, and the protection and conservation of non-timber values,
- (k) highlight the key similarities and differences between the proposed management plan, and the management plan in effect or last in effect under this Licence, and in a summary form compare
 - (i) the impact, if any, that implementation of the management plan in effect or last in effect under this Licence had, and
 - (ii) the impact, if any, that the Licensee anticipates implementation of the proposed management plan will have on factors such as those referred to in subparagraph (j),
- (l) if applicable, provide that part of the allowable annual cut will be harvested from a specified part of the Licence Area, or from a specified type of timber or terrain,
- (m) include any other information on the development, management and use of the Licence Area that the Chief Forester requires, and

(n) if required in the manual referred to in subparagraph (a), provide some or all of the information referred to in this paragraph in the form of maps meeting the requirements of the manual.

- 2.28 Subject to paragraphs 2.29 and 2.30, the Chief Forester, within two months after the date on which the Chief Forester receives a proposed management plan submitted under paragraph 2.26, subparagraph 2.31(b) or subparagraph 2.41(b), will in a notice given to the Licensee approve the proposed management plan, subject to such conditions as the Chief Forester considers necessary or appropriate, if
- (a) the Chief Forester is satisfied that the proposed management plan
 - (i) meets the requirements of paragraph 2.26 and paragraph 2.27 or clause 2.41(b)(i), as the case may be, and
 - (ii) incorporates the proposals referred to in subparagraph 2.26(b).
- 2.29 The Chief Forester, in a notice given to the Licensee, may refuse to approve a proposed management plan under paragraph 2.28 until such time as
- (a) a timber supply analysis is accepted under paragraph 2.24, or
 - (b) a 20-year plan is accepted under paragraph 2.20.
- 2.30 Where a timber supply analysis accepted under paragraph 2.24 or a 20-year plan accepted under paragraph 2.20 was not included in the proposed management plan referred to in paragraph 2.08, before approving a proposed management plan under paragraph 2.28, the Chief Forester, in a notice given to the Licensee, may require the Licensee to refer the timber supply analysis or the 20-year plan, as the case may be, to persons interested in or affected by operations under this Licence.
- 2.31 Where the Chief Forester does not approve a proposed management plan under paragraph 2.28,
- (a) subject to paragraphs 2.29 and 2.30, the Chief Forester, within two months after the date on which the Chief Forester receives the proposed management plan, will specify in a notice given to the Licensee why the Chief Forester has not approved the proposed management plan, and
 - (b) the Licensee, within one month after the date on which the Licensee is given the notice referred to in subparagraph (a), will submit a new or revised proposed management plan to the Chief Forester.
- 2.32 Subject to paragraphs 2.29 and 2.30, if

(a) the Chief Forester, within three months after the date on which the Chief Forester receives a proposed management plan submitted under paragraph 2.27, has neither

- (i) approved the proposed management plan under paragraph 2.28, nor
- (ii) given the Licensee a notice referred to in subparagraph 2.31(a), and

(b) there is a management plan in effect under this Licence,

then the term of the management plan referred to in subparagraph (b) is deemed to be extended until such time as the Chief Forester approves the proposed management plan under paragraph 2.28, or gives the Licensee a notice referred to in subparagraph 2.31(a), as the case may be.

2.33 Before approving a proposed management plan under paragraph 2.28, the Chief Forester, at his or her sole discretion and notwithstanding the Licensee's obligations under this part, may consult persons who may be interested in or affected by operations under or associated with this Licence, including but not restricted to

- (a) resource agencies,
- (b) trappers, guide outfitters, range tenure holders, and other licensed resource users,
- (c) aboriginal people,
- (d) local governments, and
- (e) members of the public,

and, subject to paragraph 2.34, may consider any comments received as a result of consultation under this paragraph.

2.34 If, because of comments received as a result of consultation under paragraph 2.33, the Chief Forester is considering

- (a) not accepting or not approving, or
- (b) imposing a condition upon acceptance or approval of,

the proposed management plan referred to in paragraph 2.33, the Regional Manager or the Chief Forester, as the case may be, will provide the Licensee with an opportunity to respond to the comments before making a decision.

MISCELLANEOUS

2.35 If the Chief Forester is satisfied that the Licensee or a Ministry employee is trying in good faith to fulfill a requirement or obligation under this Part, but for reasons beyond the control of the Licensee or the Ministry employee, as the case may be, cannot

- (a) meet a deadline referred to in this Part, or
- (b) where there is a management plan in effect under this Licence, fulfill the requirement or obligation before the management plan is due to expire,

then the Chief Forester, in a notice given to the Licensee, will, as applicable,

- (c) extend the deadline by a period the Chief Forester considers sufficient to allow the Ministry employee or the Licensee, as the case may be, to fulfill the requirement or obligation, or
- (d) extend the term of the management plan by a period the Chief Forester considers sufficient to allow the Ministry employee or the Licensee, as the case may be, to fulfill the requirement or obligation in accordance with applicable deadlines,

subject to such conditions as the Chief Forester considers necessary or appropriate.

2.36 Subject to this Licence, unless otherwise agreed to between the parties

- (a) each document accepted or approved under this part must be consistent with the documents previously accepted or approved under this part; and
- (b) subject to paragraphs 2.37 and 2.38, no acceptance or approval given under this part may be revoked or revised.

2.37 If the Licensee

- (a) submits a Timber Supply Analysis Information Package under paragraph 2.04, or the information or proposals referred to in subparagraph 2.07(b) less than 10 months,
- (b) submits a timber supply analysis under paragraph 2.22 or subparagraph 2.25(b), or a 20-year plan under paragraph 2.18 or subparagraph 2.21(b) less than 4 months, or
- (c) submits a draft management plan under paragraph 2.08 less than 12 months

prior to the date on which the management plan in effect under this licence is due to expire, the Chief Forester, in a notice given to the Licensee within one month of the date on which the applicable item is submitted, may require the Licensee to amend one or more of the items referred to in subparagraphs (a) through (c) inclusive, to the extent required to address any new issues that may have arisen and ensure consistency with any new guidelines or manuals in effect on the date the Licensee is given the notice, higher level plans, and the Acts, regulations and standards referred to in paragraph 9.01

2.38 If the Chief Forester considers that

- (a) damage to timber in the Licence Area as a result of fire, flood, wind, insects, disease, or other causes,
- (b) operations conducted in accordance with the management plan are causing or could cause serious damage to the natural environment, including soils, fisheries, wildlife, water, range, and recreation resources,
- (c) establishment, variance, cancellation or replacement of a higher level plan,
- (d) interference with an aboriginal right, or
- (e) a change in the allowable annual cut as a result of a determination by the Chief Forester under the *Forest Act*

have rendered the management plan in effect under the Licence inadequate, the Chief Forester, in a notice given to the Licensee, may require that the management plan be amended.

2.39 A notice referred to in paragraph 2.38 must specify

- (a) why the Chief Forester considers the management plan has been rendered inadequate,
- (b) the extent to which the management plan is inadequate, and
- (c) the changes required by the Chief Forester.

2.40 Where the Chief Forester gives the Licensee a notice referred to in paragraph 2.38, the Licensee, within three months after the date on which the notice is given, will submit for the Chief Forester's approval a proposed amendment to the management plan, which incorporates the changes referred to in subparagraph 2.39(c), to have effect during the unexpired term of the management plan.

- 2.41 If the Licensee fails to comply with the requirements of paragraph 2.40, the management plan in effect under this Licence will expire three months after the date on which the notice referred to in paragraph 2.38 is given to the Licensee, in which case,
- (a) within three months after the date on which the management plan expires under this subparagraph, the Licensee will
 - (i) refer a draft management plan to the Regional Manager and
 - (ii) at the same time, refer the draft management plan referred to in clause (i) to resource agencies and make it available for comment in accordance with paragraphs 2.10 and 2.11, and
 - (b) within six months after the date on which the management plan expires under this paragraph, the Licensee will submit to the Chief Forester a proposed management plan which is based on the draft management plan referred to in subparagraph (a), and a summary of
 - (i) all comments received by the Licensee in complying with the requirements of subparagraph (a), and
 - (ii) the differences, if any, between the draft management plan and the proposed management plan, including differences resulting from modifications made in response to the comments referred to in clause (i).
- 2.42 The Licensee will implement the management plan in effect under this Licence.
- 2.43 The management plan in effect under this Licence is deemed to be part of this Licence.
- 2.44 Subject to paragraphs 2.32, 2.35, and 2.41, a management plan expires five years after the date on which it takes effect.

3.00 CONDITIONS IMPOSED UPON ACCEPTANCE OR APPROVAL

- 3.01 Where under this Licence a Ministry employee has a discretion to make his or her acceptance or approval of a document or plan subject to a condition, the Ministry employee will exercise that discretion in a reasonable manner, having regard to the purposes and functions of the Ministry of Forests set out in Section 4 of the *Ministry of Forests Act* RSBC 1996, c. 300.
- 3.02 The Licensee, in a notice given to the appropriate Ministry employee within 15 days of the date on which the notice of acceptance or approval is given to the Licensee, may reject any condition to which the

acceptance or approval is subject, in which case the notice of approval or acceptance is deemed to be a notice that the applicable document or plan is not accepted or approved for the reasons set out in the conditions.

4.00 FELLING, BUCKING AND UTILIZATION SPECIFICATIONS

- 4.01 With respect to the harvesting of timber authorized under cutting permits and road permits issued prior to March 1, 2000, the conditions regarding felling, bucking and utilization included in the Licence replaced by this Licence apply, and paragraphs 4.02 to 4.09 (inclusive) of this Licence do not apply. With respect to the harvesting of timber authorized under cutting permits and road permits issued on or after March 1, 2000, the Licensee will
- (a) fell standing timber in accordance with the felling specifications set out in Schedule C,
 - (b) buck felled or dead-and-down timber of the species referred to in subparagraph (a) in accordance with the bucking specifications set out in Schedule C, and
 - (c) utilize all timber of the species and grades as specified in Parts 4.00 and 5.00 of Schedule C.
- 4.02 Timber that is not felled, bucked or utilized in accordance with paragraph 4.01 will be identified as residue or waste in an assessment under Part 5.00.
- 4.03 A cutting permit or road permit may include a requirement that the Licensee fell timber not referred to in subparagraph 4.01(a), in which case, subject to paragraph 4.06, the Licensee will fell but need not utilize such timber.
- 4.04 Subject to paragraph 4.06, the Licensee may utilize
- (a) timber of the species and grades specified in Part 6.00 of Schedule C, and
 - (b) timber referred to in paragraph 4.03.
- 4.05 Timber referred to in subparagraph 4.04(a) that is not utilized by the Licensee will be identified as residue in an assessment under Part 5.00, unless otherwise provided in the current Provincial Logging Residue and Waste Measurement Procedures Manual.
- 4.06 The Licensee will not fell standing timber, and will not buck or utilize felled or dead-and-down timber, if under an operational plan or the Acts, regulations or standards referred to in paragraph 9.01, the Licensee is required not to fell the timber, or not to buck or utilize the timber.

- 4.07 If the Licensee fells, bucks or utilizes timber contrary to paragraph 4.06, the Licensee will
- (a) within 5 business days notify the District Manager, and
 - (b) comply with any directions of the District Manager in respect of the timber.
- 4.08 The felling, bucking and utilization specifications set out in Schedule C of this Licence takes precedence over any utilization standards included in the management plan in effect under this Licence.
- 4.09 A cutting permit or road permit may include felling, bucking and utilization specifications that are different from those specified in Schedule C if mutually agreed to by the District Manager and the Licensee.

5.00 RESIDUE AND WASTE ASSESSMENTS

- 5.01 Subject to paragraphs 5.02 and 5.03, the Licensee must, on an area of land harvested under a cutting permit and, where required by the District Manager on an area of land harvested under a road permit,
- (a) carry out an assessment of the volume of residue and waste left
 - (i) within 60 days after primary logging on the area has been completed and ground being sufficiently free of snow to allow for an adequate assessment to be carried out, or
 - (ii) if primary logging on the area is not completed before the expiry of the cutting permit or the road permit, within 60 days after the expiry of the cutting permit or the road permit and ground being sufficiently free of snow to allow for an adequate assessment to be carried out,
 - (b) as part of the assessment,
 - (i) measure the timber that was not felled, or was not bucked or utilized, in accordance with the specifications set out in the Schedule C of this Licence ,
 - (ii) classify the timber referred to in clause (i) as residue or waste, and
 - (iii) classify the residue and waste as avoidable or unavoidable, and
 - (c) within 30 days upon completion of the assessment, provide the District Manager with the results of the assessment.
- 5.02 The District Manager may extend the periods referred to in subparagraph 5.01(a).

- 5.03 If, for the purpose of determining the amount of stumpage payable in respect of timber harvested under a cutting permit, the cutting permit provides that the volume or quantity of timber harvested is to be determined using information provided by a cruise of the timber conducted before the timber is cut, the District Manager may waive the requirement for an assessment of the volume of residue and waste left on the area.
- 5.04 If, in the opinion of the District Manager, the Licensee has failed to comply with the requirements of paragraph 5.01, the District Manager may carry out the assessment.
- 5.05 An assessment referred to in paragraphs 5.01 or 5.04 must be carried out in accordance with the current Provincial Logging Residue and Waste Measurement Procedures Manual.
- 5.06 The District Manager, in a notice given to the Licensee, may require the Licensee to pay in respect of avoidable waste left on an area of land authorized for harvest under a cutting permit or road permit, an amount determined in accordance with paragraph 5.07.
- 5.07 For the purpose of determining the amount payable under paragraph 5.06, the District Manager will
- (a) multiply
 - (i) the volume of avoidable waste assessed under paragraph 5.01 or 5.04 based on sawlog grades, by
 - (ii) the average stumpage rate charged for sawlogs harvested under the cutting permit in statements or invoices issued during the 12 month period ending 1 month after the month in which
 - (A) primary logging on the area was completed, or
 - (B) the cutting permit expires or is otherwise terminated, as the case may be, and
 - (b) multiply
 - (i) the volume of avoidable waste assessed under paragraph 5.01 or 5.04 based on grades other than sawlog grades, by
 - (ii) the stumpage rate charged for timber of the applicable grades.
- 5.08 If the District Manager carries out an assessment under paragraph 5.04, the District Manager, in a notice given to the Licensee, may require the Licensee to pay the costs reasonably incurred by the District Manager in carrying out the assessment.

6.00 CUT CONTROL

- 6.01 For the purposes of the definition of "5 year cut control period" in Section 53 of the *Forest Act*, the first 5 year period for this Licence begins on January 1, 1998.
- 6.02 For the purposes of subparagraph (b) of the definition of the "volume of timber harvested during a calendar year" in Section 53 of the *Forest Act*, the volume of
- (a) avoidable residue,
 - (b) unavoidable residue,
 - (c) avoidable waste, and
 - (d) unavoidable waste
- left on areas of land authorized for harvest under a cutting permit, as determined by an assessment under paragraph 5.01 or 5.04, will be charged to the Licensee as volumes of timber estimated to be wasted or damaged.

7.00 CRUISE AND APPRAISAL INFORMATION

- 7.01 The Licensee must ensure that cruise data submitted under this Licence are compiled in accordance with the current Cruising Compilation Design Manual and based on cruises carried out in accordance with the current Cruising Manual prepared by the Ministry of Forests.
- 7.02 The Licensee must ensure that appraisal data submitted under this Licence are
- (a) compiled in accordance with, and
 - (b) include all data required under,
- the policies and procedures approved by the Minister from time to time under Section 105 of the *Forest Act* for the forest region in which the Licence Area is located.

8.00 CUTTING PERMITS

- 8.01 Subject to paragraphs 8.02 through 8.04 inclusive, the Licensee may submit an application to the District Manager for a cutting permit to authorize the Licensee to harvest the portion of the allowable annual cut available to the Licensee.

- 8.02 The Licensee may only submit an application for a cutting permit to authorize the Licensee to harvest one or more proximate areas of Crown land that are either
- (a) identified on a forest development plan for which the Licensee may, during the term of the forest development plan, apply for a cutting permit, or
 - (b) exempted under the *Forest Practices Code of British Columbia Act* from the requirement for a forest development plan.
- 8.03 Before submitting an application for a cutting permit, the Licensee must compile
- (a) cruise data, and
 - (b) appraisal data
- in accordance with the requirements of Part 7.00, for the areas to be included in the application.
- 8.04 An application for a cutting permit submitted under paragraph 8.01 must
- (a) be in a form acceptable to the District Manager,
 - (b) include
 - (i) a map to a scale acceptable to the District Manager showing the areas referred to in the application,
 - (ii) the cruise data and appraisal data referred to in paragraph 8.03, and
 - (c) if required by the District Manager, identify the sequence in which the areas of land referred to in the application would be harvested if a cutting permit is issued.
- 8.05 The areas of land shown on the map referred to in clause 8.04(b)(i) must be consistent with
- (a) cutblocks referred to in subparagraph 8.02(a), or
 - (b) areas referred to in subparagraph 8.02(b),
- allowing for difference due to scale variation between maps used in the forest development plan or exemption and the map referred to in clause 8.04(b)(i).
- 8.06 Subject to paragraphs 8.08 through 8.10 inclusive, upon receipt of an application for a cutting permit submitted under paragraph 8.01, the District Manager will issue a cutting permit to the Licensee if
- (a) there is a management plan in effect under this Licence,
 - (b) the District Manager is satisfied that

- (i) the requirements of paragraphs 8.02 through 8.05 inclusive have been met, and
 - (ii) the cruise data and appraisal data referred to in clause 8.04(b)(ii) meets the requirements of Part 7.00,
 - (c) the District Manager is satisfied that activities and operations under or associated with the cutting permit will be consistent with this Licence, higher level plans, the management plan referred to in subparagraph (a), and any operational plans approved in respect of the areas of land referred to in the cutting permit.
- 8.07 The District Manager may consult aboriginal people who claim to have an aboriginal interest that may be affected by activities or operations under or associated with a cutting permit.
- 8.08 The District Manager may impose conditions in a cutting permit to address an aboriginal interest.
- 8.09 The District Manager may refuse to issue a cutting permit if, in the opinion of the District Manager, issuance of the cutting permit would result in an unjustifiable infringement of an aboriginal interest.
- 8.10 The District Manager may refuse to issue a cutting permit if a silviculture prescription required under the *Forest Practices Code of British Columbia Act* has not been approved for an area of land referred to in the application for the cutting permit.
- 8.11 If the District Manager
- (a) determines that a cutting permit may not be issued because the requirements of paragraph 8.06 have not been met,
 - (b) is carrying out consultations under paragraph 8.07, or
 - (c) refuses to issue a cutting permit under paragraph 8.09 or 8.10
- the District Manager will notify the Licensee within 45 days of the date on which the application for the cutting permit was received.
- 8.12 A cutting permit must
- (a) identify the boundaries of the areas of Crown land which, subject to this Licence, the Licensee is authorized to harvest,
 - (b) specify a term which, subject to paragraph 8.14, does not exceed three years,
 - (c) specify a timber mark to be used in conjunction with the timber harvesting operations carried on under the cutting permit,

- (d) specify whether, for the purpose of determining the amount of stumpage payable in respect of timber harvested under the cutting permit, the volume or quantity of timber is to be determined using information provided by
 - (i) a scale of the timber, or
 - (ii) a cruise of the timber conducted before the timber is cut,
- (e) include such other provisions, consistent with this Licence, as the District Manager considers necessary or appropriate

8.13 Subject to 8.14, the District Manager may amend a cutting permit only with the consent of the Licensee.

8.14 With or without the consent of the Licensee, the District Manager, in a notice given to the Licensee, may

- (a) extend the term of a cutting permit, and
- (b) if he or she does so, amend the cutting permit to the extent necessary to ensure the cutting permit is consistent with the forest development plan in effect under this Licence at the time the cutting permit is extended.

8.15 A cutting permit is deemed to be part of this Licence.

8.16 All cutting permits in effect that were issued under the tree farm licence that is replaced by this Licence continue under this Licence for the duration of their respective terms.

9.00 LEGISLATIVE FRAMEWORK

9.01 This Licence is subject to

- (a) the *Forest Act* and the regulations made under that Act, and
- (b) the *Forest Practices Code of British Columbia Act* and the regulations and standards made under that Act.

9.02 Nothing in this Licence or a cutting permit issued under this Licence is to be construed as authorizing the Licensee to engage in any activities or carry out any operations otherwise than in compliance with the requirements of the Acts, regulations and standards referred to in paragraph 9.01.

10.00 ABORIGINAL RIGHTS AND/OR TITLE

10.01 Notwithstanding any other provision of this Licence, if a court of competent jurisdiction

- (a) determines that activities or operations under or associated with this Licence will unjustifiably infringe an aboriginal right and/or title,
- (b) grants an injunction further to a determination referred to in subparagraph (a), or
- (c) grants an injunction pending a determination of whether activities or operations under or associated with this Licence will unjustifiably infringe an aboriginal right and/or title,

the Regional Manager or District Manager, in a notice given to the Licensee, may vary or suspend, in whole or in part, or refuse to issue a cutting permit, road permit or special use permit, or a free use permit issued to the Licensee so as to be consistent with the court determination.

10.02 Subject to this Licence and the Acts, regulations and standards referred to in paragraph 9.01, if

- (a) under paragraph 10.01, the Regional Manager or District Manager has varied a cutting permit, road permit or special use permit, or a free use permit issued to the Licensee,
- (b) a court of competent jurisdiction subsequently overturns, sets aside or dissolves the determination or injunction referred to in that paragraph, and
- (c) it is practical to do so,

the Regional Manager or District Manager, at the request of the Licensee, will vary the permit to reflect as closely as possible, for the remainder of its term, the terms and conditions of the permit prior to the variation under paragraph 10.01.

10.03 Subject to this Licence and the Acts, regulations and standards referred to in paragraph 9.01, if

- (a) under paragraph 10.01, the Regional Manager or District Manager has suspended a cutting permit, road permit or special use permit, or a free use permit issued to the Licensee,
- (b) a court of competent jurisdiction subsequently overturns, sets aside or dissolves the determination or injunction referred to in that paragraph, and
- (c) it is practical to do so,

the Regional Manager or District Manager, at the request of the Licensee, will reinstate the permit for the remainder of its term.

- 10.04 Subject to this Licence, if
- (a) under paragraph 10.01, the Regional Manager or District Manager has refused to issue a cutting permit, road permit or special use permit, or a free use permit issued to the Licensee,
 - (b) a court of competent jurisdiction subsequently overturns, sets aside or dissolves the determination or injunction referred to in that paragraph, and
 - (c) it is practical to do so,
- the Regional Manager or District Manager, at the request of the Licensee, will issue the permit.

11.00 REPORTING

- 11.01 The Regional Manager, in a notice given to the Licensee by April 1, may require the Licensee to submit a report containing such information as the Regional Manager requires regarding
- (a) the Licensee's performance of its obligations under or in respect of this Licence, the approved management plan, the allowable annual cut rationale, and conditions from the Chief Forester's management plan approval letter, and
 - (b) the processing or other use or disposition of the timber harvested under this Licence.
- in the previous calendar year if the information is not included in any other reports which the Licensee must submit under the Acts or regulations referred to in paragraph 9.01.
- 11.02 Upon receipt of a notice referred to in paragraph 11.01, the Licensee, on or before the date specified in the notice, must submit a report to the Regional Manager containing the required information.
- 11.03 Subject to paragraph 11.04, the Regional Manager may include the information contained in a report submitted under paragraph 11.02 in any reports prepared by the Ministry of Forests for public review.
- 11.04 Subject to the *Freedom of Information and Protection of Privacy Act*, the Regional Manager will not disclose information provided in confidence by the Licensee in a report submitted under paragraph 11.02.

12.00 FINANCIAL AND DEPOSITS

- 12.01 In addition to any money payable under the Acts and regulations referred to in paragraph 9.01 in respect of this Licence, a cutting permit, road permit or special use permit, or a free use permit issued to the Licensee, the Licensee will pay to the Crown, immediately upon receipt of a notice, statement or invoice issued on behalf of the Crown,
- (a) stumpage under Part 7 of the *Forest Act* in respect of timber harvested
 - (i) under a cutting permit from
 - (A) Schedule B Land, or
 - (B) Schedule A Land subject to a timber licence, or
 - (ii) under a road permit,at rates determined, redetermined and varied under Section 105 of that Act, and
 - (b) any payments required under Part 5.00 or Part 14.00.
- 12.02 During the term of this Licence, the Licensee will maintain with the Crown a deposit in the amount prescribed under the *Forest Act* or the regulations made under that Act, in a form acceptable to the Minister, as security for the Licensee's performance of its obligations under or in respect of this Licence, a cutting permit, road permit or special use permit, or a free use permit issued to the Licensee.
- 12.03 If the Regional Manager or District Manager gives the Licensee a notice that an amount has been taken under this Part from the deposit, the Licensee, within four weeks of the date on which the notice is given, will pay to the Crown, in a form acceptable to the Minister, an amount sufficient to replenish the deposit.
- 12.04 If the Licensee fails
- (a) to pay money that the Licensee is required to pay to the Crown under
 - (i) this Licence, a cutting permit, road permit or special use permit, or a free use permit issued to the Licensee, or
 - (ii) in respect of this Licence, a cutting permit, road permit or special use permit, or a free use permit issued to the Licensee, or
 - (b) to otherwise perform its obligations under
 - (i) this Licence, a cutting permit, road permit or special use permit, or a free use permit issued to the Licensee, or

- (ii) in respect of this Licence, a cutting permit, road permit or special use permit, or a free use permit issued to the Licensee, the Regional Manager or District Manager, after at least four weeks notice to the Licensee, may take from the deposit
 - (c) an amount equal to the money which the Licensee failed to pay,
 - (d) an amount sufficient to cover all costs reasonably incurred by the Regional Manager or District Manager in remedying the Licensee's failure to perform its obligations, or
 - (e) an amount equal to the Regional Manager's or District Manager's estimate of the costs which the Regional Manager or District Manager could reasonably expect to incur in remedying the Licensee's failure to perform its obligations,
- and for that purpose a security included in the deposit may be realized.

12.05 A notice referred to in paragraph 12.04 must specify

- (a) the money which the Licensee has failed to pay or the obligation which the Licensee has failed to perform, and
- (b) the amount the Regional Manager or District Manager intends to take from the deposit.

12.06 Subject to paragraphs 12.08, 12.09 and 12.10, if

- (a) the Regional Manager or District Manager, under paragraph 12.04, takes from the deposit an amount equal to the Regional Manager's or District Manager's estimate of the costs which the Regional Manager or District Manager could reasonably expect to incur in remedying the Licensee's failure to perform its obligations, and
- (b) the costs reasonably incurred by the Regional Manager or District Manager in remedying the Licensee's failure to perform its obligations are less than the amount taken from the deposit,

the Crown will as soon as feasible return to the Licensee an amount equal to the difference between the amount taken from the deposit and the costs reasonably incurred by the Regional Manager or District Manager.

12.07 If

- (a) the Regional Manager or District Manager, under paragraph 12.04, takes from the deposit an amount equal to the Regional Manager's or District Manager's estimate of the costs which the Regional Manager or District Manager could reasonably expect to incur in remedying the Licensee's failure to perform its obligations, and
- (b) the costs reasonably incurred by the Regional Manager or District Manager in remedying the Licensee's failure to perform its obligations are greater than the amount taken from the deposit,

the Regional Manager or District Manager may take from the deposit an additional amount equal to the difference between the costs incurred by the Regional Manager or District Manager and the amount originally taken from the deposit, and for that purpose a security included in the deposit may be realized.

12.08 If the Regional Manager or District Manager, under paragraph 12.04, takes from the deposit an amount equal to the Regional Manager's or District Manager's estimate of the costs which the Regional Manager or District Manager could reasonably expect to incur in remedying the Licensee's failure to perform its obligations, the Regional Manager or District Manager is under no obligation to remedy the Licensee's failure.

12.09 If

- (a) the Regional Manager or District Manager, under paragraph 12.04, takes from the deposit an amount equal to the Regional Manager's or District Manager's estimate of the costs which the Regional Manager or District Manager could reasonably expect to incur in remedying the Licensee's failure to perform its obligations,
- (b) the Regional Manager or District Manager does not remedy the Licensee's failure to perform its obligations, and
- (c) the Regional Manager or District Manager gives a notice to the Licensee indicating that the Crown will not be remedying the Licensee's failure to perform its obligations,

subject to paragraph 12.10, the Crown may retain the amount taken from the deposit under paragraph 12.04.

12.10 If, after receiving a notice referred to in paragraph 12.09, the Licensee

- (a) remedies the failure to perform its obligations, and

- (b) gives a notice to that effect to the Regional Manager or District Manager within three months of the date on which the notice referred to in paragraph 12.09 is given to the Licensee, or within such longer period as the Regional Manager may approve,

the Crown will return to the Licensee an amount equal to the difference between the amount taken from the deposit and any costs reasonably incurred by the Regional Manager or District Manager in respect of the Licensee's failure to perform its obligations.

12.11 If the Regional Manager or District Manager considers that

- (a) any activity or operation that may be engaged in or carried out under this Licence, a cutting permit, road permit or special use permit, or a free use permit issued to the Licensee, is likely to cause damage to persons or property, and
- (b) the deposit is insufficient to indemnify the Crown for any liability which the Crown might incur as a consequence of the activity or operation,

the Regional Manager or District Manager may require the Licensee to maintain with the Crown a special deposit, in a form acceptable to the Minister, in the amount determined by the Regional Manager or District Manager, as the case may be, and the Licensee will comply.

12.12 If the Licensee fails to

- (a) remedy any damage resulting from an activity or operation referred to in paragraph 12.11, or
- (b) compensate any person who suffers a loss as a result of an activity or operation referred to in paragraph 12.11,

the Regional Manager or District Manager, after at least four weeks notice to the Licensee, may take an amount from the special deposit sufficient to indemnify the Crown for any liability which is or may be incurred by the Crown as a consequence of a failure referred to in subparagraph (a) or (b).

12.13 A notice referred to in paragraph 12.12 must specify

- (a) the nature of the Licensee's failure, and
- (b) the amount the Regional Manager or District Manager intends to take from the special deposit.

12.14 Subject to the *Forest Act* and the regulations made under that Act, the Crown will return to the Licensee

- (a) the deposit, less deductions made under paragraphs 12.04 and 12.07, when
 - (i) this Licence expires and is not replaced under Section 36 of the *Forest Act*, or is surrendered, and
 - (ii) the Regional Manager is satisfied that the Licensee has fulfilled its obligations under this Licence, and
- (b) a special deposit, less deductions made under paragraph 12.12, when the Regional Manager is satisfied that the Crown is no longer at risk of being held liable as a consequence of an activity or operation referred to in paragraph 12.11.

13.00 ACCESS AND ACCOMMODATION

- 13.01 Nothing in this Licence authorizes the Licensee to in any way restrict the Crown's right of access to Schedule B Land or Schedule A Land subject to a timber licence.
- 13.02 The Regional Manager or District Manager may carry out on Schedule B Land and Schedule A Land subject to a timber licence
 - (a) silviculture the Crown is required to carry out, under the Acts or regulations referred to in paragraph 9.01, and
 - (b) any other silviculture, provided it does not
 - (i) compromise the management plan in effect under this Licence or a forest development plan approved in respect of this Licence, or
 - (ii) unreasonably interfere with the Licensee's operations under this Licence.
- 13.03 Where the Regional Manager or District Manager carries out silviculture referred to in paragraph 13.02, the Regional Manager or District Manager, as the case may be, will ensure the silviculture is consistent with the intent of the management plan in effect under this Licence, except where the Regional Manager or District Manager is required to depart from the intent of the management plan because of the requirements of a higher level plan or the Acts, regulations or standards referred to in paragraph 9.01.
- 13.04 Any Ministry employee may
 - (a) enter onto Schedule A Land that is not subject to a timber licence, and
 - (b) use roads owned or deemed to be owned by the Licensee, and,

for the purpose of fulfilling an obligation or exercising a right under this Licence.

- 13.05 The Licensee will allow any person who has been granted harvesting rights to timber referred to in paragraphs 1.09, 1.10, 1.11 or 1.18 to use any road referred to in subparagraph 13.04(b) for the purpose of gaining access to timber within the Licence Area.
- 13.06 The Licensee will not require any payment from a person referred to in paragraph 13.05 other than a reasonable payment in respect of the actual maintenance costs of the road.
- 13.07 Upon reasonable notice from the Regional Manager or District Manager, the Licensee will provide a Ministry employee with reasonable office and living accommodation on premises owned or operated by the Licensee in or near the Licence Area, to enable the Ministry employee to fulfill an obligation or exercise a right under this Licence.
- 13.08 The Licensee may charge the Regional Manager or District Manager, as the case may be, for costs reasonably incurred in providing the accommodation referred to in paragraph 13.07.

14.00 CONTRACTORS

- 14.01 Each year during the term of this Licence, the Licensee will ensure that not less than
- (a) 50% of the volume of timber harvested by or on behalf of the Licensee from the Licence Area during the year, multiplied by
 - (b) the result obtained by the division of
 - (i) the portion of the allowable annual cut that the Chief Forester determines is attributable to Schedule B Land, by
 - (ii) the allowable annual cut,
- is harvested by persons under contract with the Licensee.
- 14.02 Compliance with paragraph 14.01 will be calculated in accordance with the method prescribed under the *Forest Act* or the regulations made under that Act.
- 14.03 If in a calendar year the volume of timber harvested by persons under contract with the Licensee is less than the volume required under paragraph 14.01, the Regional Manager, in a notice given to the Licensee, may require the Licensee to pay an amount determined in accordance with paragraph 14.04.
- 14.04 For the purpose of determining the amount payable under paragraph 14.03, the Regional Manager will multiply

- (a) the volume required under paragraph 14.01, minus the volume harvested during the calendar year by persons under contract, by
- (b) the average stumpage rate charged for sawlogs in statements or invoices issued to the Licensee during the calendar year in respect of timber harvested under this Licence.

14.05 The Minister may relieve the Licensee from the requirements of this Part to the extent provided for under the *Forest Act* or the regulations made under that Act.

14.06 The Licensee may contract to have more than the volume required under paragraph 14.01 harvested by persons under contract.

15.00 TIMBER PROCESSING

15.01 During the term of this Licence, the Licensee will make no less than 50 percent of the annual "bush run" volume, sorted or unsorted, representing a cross section of species, size and quality for the Licence Area, available for competitive sale on the open market.

15.02 The pulpwood component of the volume referred to in paragraph 15.01 is recognized as being committed through the existing agreement between the Licensee and Georgia Pacific, until the earlier of the termination of that agreement or its expiry on April 30, 2001, unless otherwise extended.

15.03 The volumes referred to in paragraph 15.01 will be sold by sealed tender with the highest bidder, if any bid is to be accepted, being awarded the timber.

15.04 Records of all bids received as per paragraph 15.03 and volumes sold thereunder will be forwarded quarterly to the District Manager.

15.05 The volumes not sold as per paragraph 15.01 or their equivalent must be processed in the Revelstoke area.

16.00 LIABILITY AND INDEMNITY

- 16.01 Subject to paragraph 16.03, the Licensee will indemnify the Crown against and save it harmless from all claims, demands, suits, actions, causes of action, costs, expenses and losses faced, incurred or suffered by the Crown as a result, directly or indirectly, of any act or omission of
- (a) the Licensee,
 - (b) an employee of the Licensee,
 - (c) an agent of the Licensee,
 - (d) a contractor of the Licensee who engages in any activity or carries out any operation, including but not restricted to harvesting operations, under or associated with this Licence, a cutting permit, road permit or special use permit, or a free use permit issued to the Licensee, or
 - (e) any other person who on behalf of or with the consent of the Licensee engages in any activity or carries out any operation, including but not restricted to harvesting operations, under or associated with this Licence, a cutting permit, road permit or special use permit, or a free use permit issued to the Licensee.
- 16.02 For greater certainty, the Licensee has no obligation to indemnify the Crown under paragraph 16.01 in respect of any act or omission of
- (a) an employee, agent or contractor of the Crown, in the course of carrying out his or her duties as employee, agent or contractor of the Crown, or
 - (b) a person, other than the Licensee, to whom the Crown has granted the right to use or occupy Crown land, including a person who has been granted the right to harvest timber referred to in paragraphs 1.09, 1.10, 1.11 or 1.18, in the course of exercising those rights.
- 16.03 Paragraph 16.01 does not apply to an act or omission which is a direct response to, and complies with, an order made by a Ministry employee or another officer of the Crown.

16.04 Amounts taken under Part 12.00 from the deposit or a special deposit, any payments required under Part 5.00 or Part 14.00, any reductions made under the *Forest Act* and regulations to the portion of the allowable annual cut available to the Licensee, and payments required further to the indemnity referred to in paragraph 16.01 are in addition to and not in substitution for any other remedies available to the Crown in respect of a default of the Licensee.

17.00 LIMITATION OF LIABILITY

17.01 The Crown is not liable to the Licensee for injuries, losses, expenses, or costs incurred or suffered by the Licensee as a result, directly or indirectly, of an act or omission of a person who is not a party to this Licence, including but not restricted to an act or omission of a person disrupting, stopping or otherwise interfering with the Licensee's operations under this Licence by road blocks or other means.

18.00 TERMINATION

18.01 If this Licence expires and is not replaced under Section 36 of the *Forest Act*, or is surrendered, cancelled or otherwise terminated,

- (a) all cutting permits will immediately terminate, and
- (b) timber, including logs and special forest products, harvested from Schedule B Land under the authority of this Licence and that are still located on the Licence area, will vest in the Crown, without right of compensation to the Licensee, and
- (c) unless otherwise agreed to between the District Manager and the Licensee prior to the surrender, cancellation or termination of this Licence, title to all improvements, including roads and bridges, constructed by the Licensee on Crown land under the authority of this Licence will vest in the Crown, without right of compensation to the Licensee, and
- (d) the Licensee may continue to enter and use Schedule B Land for a period of one month after the expiry or termination of this Licence for the purpose of removing the Licensee's property.

18.02 The Licensee will not remove any improvements or timber referred to in subparagraph 18.01(b), unless authorized to do so by the Regional Manager.

- 18.03 If the Licensee commits an act of bankruptcy, makes a general assignment of its creditors or otherwise acknowledges its insolvency the Licensee is deemed to have failed to perform an obligation under this Licence.

19.00 NOTICE

- 19.01 A notice given under this Licence must be in writing.
- 19.02 A notice given under this Licence may be
- (a) delivered by hand,
 - (b) sent by mail, or
 - (c) subject to paragraph 19.05, sent by facsimile transmission,
- to the address or facsimile number, as applicable, specified on the first page of this Licence, or to such other address or facsimile number as is specified in a notice given in accordance with this Part.
- 19.03 If a notice is given under this Licence, it is deemed to have been given
- (a) if it is given in accordance with subparagraph 19.02(a), on the date it is delivered by hand,
 - (b) if it is given in accordance with subparagraph 19.02(b), subject to paragraph 19.04, on the eighth day after its deposit in a Canada Post Office at any place in Canada, and
 - (c) if it is given in accordance with subparagraph 19.02(c), subject to paragraph 19.05, on the date it is sent by facsimile transmission.
- 19.04 If, between the time a notice is mailed in accordance with subparagraph 19.02(b) and the time it is actually received, there occurs a postal strike, lockout or slowdown that might reasonably affect delivery of the notice, the notice is not deemed to be given until the party actually receives it.
- 19.05 If a notice is sent by facsimile transmission, the party sending the notice must take reasonable steps to ensure that the transmission has been successfully completed.

20.00 MISCELLANEOUS

- 20.01 This Licence will enure to the benefit of, and be binding on, the parties and their respective heirs, executors, successors and permitted assigns.
- 20.02 The laws of British Columbia will govern the interpretation of this Licence and the performance of the parties' obligations under this Licence.

- 20.03 The Licensee will use the services of one or more professional foresters to manage the Licence Area.
- 20.04 At the request of the Regional Manager or District Manager, the Licensee will survey and define on the ground any or all boundaries of the Licence Area.
- 20.05 Where
- (a) the boundaries of the Licence Area are based on boundaries established under existing or expired timber licences,
 - (b) the legal description of the boundaries of the Licence Area has been derived from original timber licence survey plans or from reference maps prepared from original timber licence survey plans, and
 - (c) the legal description differs from the actual ground location of timber licence corner posts,
- the boundaries of the Licence Area are the boundaries as originally established by the actual ground location of the timber licence corner posts.
- 20.06 Any power conferred or duty imposed on a Ministry employee referred to in this Licence may be exercised or fulfilled by another Ministry employee designated or authorized to do so by the Minister, the Chief Forester, the Regional Manager, or the District Manager, as appropriate.
- 20.07 Where under this Licence the Minister or a Ministry employee has a discretion to require information, the Minister or Ministry employee, as the case may be, will exercise this discretion in a reasonable manner, having regard to the purposes and functions of the Ministry of Forests set out in Section 4 of the *Ministry of Forests Act* RSBC 1996, c. 300.
- 20.08 Subject to this Licence and all applicable legislation, including but not restricted to the Acts, regulations and standards referred to in paragraph 9.01, the Minister will ensure that the obligations under this Licence of the Ministry employees referred to in this Licence are fulfilled.
- 20.09 Nothing in this Licence entitles the Licensee to have an area of Schedule B Land, or Schedule A Land subject to a timber licence, replaced with another area, or to have harvesting rights awarded under another agreement under the *Forest Act*, in the event timber is damaged or destroyed by pests, fire, wind or other natural causes, or an area of land is deleted from the Licence Area under the Acts or regulations referred to in paragraph 9.01, or under any other Act or regulation.
- 20.10 The Schedules to this Licence are deemed to be part of this Licence.

21.00 INTERPRETATION & DEFINITIONS

21.01 This Licence is divided into parts, paragraphs, subparagraphs, clauses and subclauses, illustrated as follows:

1.00 PART;

1.01 PARAGRAPH;

(a) SUBPARAGRAPH;

(i) CLAUSE;

(A) SUBCLAUSE;

and a reference to a subparagraph, clause or subclause is to be construed as a reference to a subparagraph, clause or subclause of the paragraph, subparagraph or clause, as the case may be, in which the reference occurs.

21.02 In this Licence, unless the context otherwise requires,

- (a) "aboriginal interest" means potential for aboriginal right(s) and/or title.
- (b) "aboriginal people" includes registered and non-registered Indians, Inuits and Metis,
- (c) "allowable annual cut" means the allowable annual cut determined by the Chief Forester for the Licence Area in accordance with the requirements of the *Forest Act*,
- (d) "average stumpage rate charged for sawlogs" means the total stumpage charged for sawlogs divided by the total volume of sawlogs,
- (e) "avoidable" in respect of residue or waste means timber that does not fall within the definition of unavoidable,
- (f) "cultural heritage resource" means an object, a site or the location of a traditional societal practice that is of historic, cultural, or archaeological significance to the Province, a community or an aboriginal people,
- (g) "close" or "closure" means cessation of production of the principal forest products normally produced by a timber processing facility,
- (h) "cutting permit" means a cutting permit issued under this Licence or a cutting permit referred to in paragraph 8.16,
- (i) "deposit" means the deposit referred to in paragraph 12.02,

- (j) "District Manager" means
 - (i) a District Manager appointed under the *Ministry of Forests Act*, for a forest district in which all or part of the Licence is situated, and
 - (ii) any person authorized by the District Manager to exercise a power or fulfil a duty under this Licence,
- (k) "*Forest Act*" means the *Forest Act*, R.S.B.C. 1996 , c. 157 , as amended from time to time, or the successor to this Act if it is repealed,
- (l) "forest development plan" means a forest development plan referred to in the *Forest Practices Code of British Columbia Act*
- (m) "*Forest Practices Code of British Columbia Act*" means the *Forest Practices Code of British Columbia Act*, B.C. 1996, c. 159 , as amended from time to time, or the successor to this Act if it is repealed,
- (n) "free use permit" means a free use permit issued under the *Forest Act* to
 - (i) the Licensee, or
 - (ii) to a person other than the Licensee,
 to authorize the harvest of timber within the Licence Area,
- (o) "guideline" means a guideline, guidebook, policy, procedure or manual regarding forest practices applicable to all or part of the Licence Area, which has been set or approved by the Ministry,
- (p) "higher level plan" means a higher level plan that is applicable to all or part of the Licence Area,
- (q) "Licence Area" means Schedule A Land and Schedule B Land,
- (r) "management plan" means a plan approved under the TFL for managing, protecting and conserving both the timber resources and the non-timber values and resources of the Licence Area, and integrating harvesting and related activities with use of the Licence Area for purposes other than timber production,
- (s) "manual" means a guideline, guidebook, policy, procedure, or manual set or approved by the Ministry for preparation of:
 - (i) a Statement of Management Objectives, Options and Procedures,
 - (ii) a Timber Supply Analysis Information Package,
 - (iii) a timber supply analysis,

- (iv) a management plan,
- (v) inventories referred to in Part 2.00,
- (t) "Ministry" means the Ministry of Forests,
- (u) "Ministry officer" means an employee of the Ministry,
- (v) "person" includes a corporation and a partnership,
- (w) "pest" means any animal, insect, fungus, bacteria, virus, nematode, or other organism which is detrimental to effective forest management,
- (x) "primary logging" means felling timber and yarding or forwarding the timber to central landings or road-sides, but does not include removing the timber from these landings or road-sides,
- (y) "Regional Manager" means
 - (i) a Regional Manager appointed under the *Ministry of Forests Act*, for a forest region in which all or part of the Licence Area is situated, and
 - (ii) any person authorized by the Regional Manager to exercise a power or fulfil a duty under this Licence,
- (z) "residue" means timber of a species and grade specified as optional utilization in Schedule "C" of this Licence or any cutting permits issued in accordance with this licence, that is not utilized by the Licensee, unless otherwise provided in the current Provincial Logging Residue and Waste Measurement Procedures Manual,
- (aa) "resource agencies" means any governmental agency, Ministry or department having jurisdiction over a resource which may be affected by any activity or operation, including but not restricted to harvesting activities or operations, engaged in or carried out under or associated with this Licence or a road permit,
- (bb) "review strategy" means a plan for obtaining input from resource agencies and interested persons regarding management and development of the Licence Area,
- (cc) "road permit" means a road permit entered into under the *Forest Act* which provides access to timber harvested, or to be harvested, under this Licence,
- (dd) "Schedule A Land" means the land described in Schedule "A" to this Licence,
- (ee) "Schedule B Land" means the Crown land described in Schedule "B" to this Licence,

- (ff) "silviculture prescription" means a silviculture prescription referred to in the *Forest Practices Code of British Columbia Act*,
- (gg) "special deposit" means a special deposit referred to in paragraph 12.11,
- (hh) "special use permit" means a special use permit issued under the *Forest Act* before June 15, 1995, or under the *Forest Practices Code of British Columbia Act* on or after June 15, 1995, to authorize the Licensee to use or occupy Crown land within the Licence Area,
- (ii) "timber harvesting land base" means the portion of the total Licence Area considered to contribute to, and be available for, long-term timber supply.
- (jj) "timber supply analysis" means an analysis of the short-term and long-term availability of timber for harvesting in the Licence Area, including an analysis of the short and long-term effect of management practices on the availability of timber,
- (kk) "Timber Supply Analysis Information Package" means information relating to the preparation of a timber supply analysis, including information regarding the assumptions to be incorporated into a timber supply analysis, and the methodology to be used in the timber supply analysis,
- (ll) "Timber Supply Forester" means the Ministry employee designated by the Chief Forester to review the timber supply analysis information package and the timber supply analysis,
- (mm) "20-year plan" means an operational timber supply projection for the Licence Area, prepared in support of a timber supply analysis, that indicates the availability of timber over a period of not less than 20 years,
- (nn) "unavoidable" in respect of residue or waste means timber that was not felled, or was not bucked or utilized, in accordance with the specifications set out in Schedule C of this Licence, because the timber
 - (i) is inaccessible or physically obstructed,
 - (ii) could not be felled, bucked or utilized safely, or
 - (iii) could not be felled, bucked or utilized because of the restriction referred to in paragraph 4.06,
- (oo) "utilize" means to remove timber from the Licence Area for use or processing elsewhere,

(pp) "waste" means timber referred to in paragraph 4.01 that is not felled, bucked or utilized in accordance with the requirements of Schedule C of this Licence.

- 21.03 Unless otherwise provided in paragraph 21.02, if a word or phrase used in this Licence is defined in the *Forest Act* or the *Forest Practices Code of British Columbia Act* the definition in the Act applies to this Licence, and where the word or phrase in the Act is replaced by a new word or phrase, this Licence is deemed to have been amended accordingly.
- 21.04 If a provision of the *Forest Act* or the *Forest Practices Code of British Columbia Act* referred to in this Licence is renumbered, the reference in this Licence is to be construed as a reference to the provision as renumbered.
- 21.05 In this Licence, unless the context otherwise requires,
- (a) the singular includes the plural and the plural includes the singular, and
 - (b) the masculine, the feminine and the neuter are interchangeable.

IN WITNESS WHEREOF this Licence has been executed by the Minister and the Licensee on the dates written below:

SIGNED by the Minister)
on behalf of Her Majesty)
the Queen in Right of)
the Province of)
British Columbia)
in the presence of:)

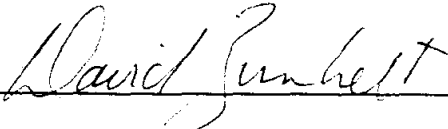

))
BRIAN GILES)
Minister Staff.)

))
The Honourable David Zirnelt
Minister of Forests

Date: DEC. 8, 1999

THE COMMON SEAL of)
the Licensee was affixed)
in the presence of:)

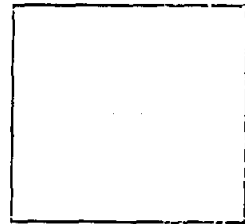
))
_____))
_____)



OR

SIGNED by the Licensee)
in the presence of:)
))
_____))
_____)

))
(Licensee)

Date: OCT 27/99

SCHEDULE "A"
GOLDSTREAM TREE FARM LICENCE
TREE FARM LICENCE NUMBER 56

Forest lands and merchantable timber in other tenures owned or controlled by the Licensee within Tree Farm Licence Number 56.

Crown Grants

Nil

<u>Timber Licence</u>	<u>Replaces Special Timber Licence</u>	<u>Land District</u>	<u>Hectares</u>
T0617	TL 2328P	Kootenay	106
T0646	TL 4898P	Kootenay	259
T0648	TL 5372P	Kootenay	138
T0658	TL 12439P	Kootenay	148
T0662	TL 12440P	Kootenay	<u>259</u>
		TOTAL	<u>910</u>

SCHEDULE "B"
GOLDSTREAM TREE FARM LICENCE
TREE FARM LICENCE NUMBER 56

Interpretation of Schedule B, TFL 56

1. Schedule "B" Land

1.1 For the purposes of the definition of "Schedule 'B' Land" in Paragraph 21.02 of this Licence, "Crown land described in Schedule 'B'" means all Crown land within the boundaries described in Paragraph 2, except for Alienated Crown Land.

2. Boundaries

2.1 The boundaries referred to in Paragraph 1 are as follows:

"Metes and bounds legal description"

3. Interpretation

3.1 "Alienated Crown Land" means Crown land which is not available for inclusion in Schedule "B" Land and, without restricting the generality of the foregoing, includes Crown land which:

(a) is, as of the effective date of this Licence, within the area of:

(i) a park or ecological reserve;

(ii) a lease, licence of exclusive occupation, or timber licence held by a person other than the Licensee, or

(iii) a highway (or road) right of way where the highway (or road) is or is deemed, declared or determined to be a public highway under the *Highway Act* (or a Forest Service road under the *Forest Act*); or

(b) becomes vested in the Crown by escheat, reversion, transfer or otherwise during the term of this Licence, except as provided in this Licence.

3.2 The map(s) accompanying this Schedule are for convenience only, and if there is any discrepancy between the map(s) and the description of boundaries in Paragraph 2, the description in Paragraph 2 will be deemed to be correct.

3.3 All alienated Crown Land may not be identified as such on the attached Schedules and maps.

Note: Crown land does not include land owned by an agent of the Crown, nor land vested in the federal Crown.

Active amendments and instruments of (former) Tree Farm Licence Number 56, which are currently in effect and are not described in Schedule "B", and are not needed on the document map(s).

SCHEDULE "B"

GOLDSTREAM TREE FARM LICENCE

TREE FARM LICENCE NUMBER 56

<u>Document</u>	<u>Date</u>	<u>Particulars</u>
Nil		

SCHEDULE "B"
GOLDSTREAM TREE FARM LICENCE
TREE FARM LICENCE NUMBER 56

All Crown lands not otherwise alienated within the area outlined in bold black on the accompanying map except Crown land reverted subsequent to 1971, which was subject to an old temporary tenure (within the meaning of the *Forest Act* assented to March 30, 1972) and held by a person other than the licensee.

Commencing at the confluence of the natural boundaries of Cap Creek on the left bank thereof and Revelstoke Lake on the easterly shore thereof; thence in a general northeasterly direction along the natural boundary of said Cap Creek on the left bank thereof to a point being 400 metres south and 3.100 kilometres east of the northeast corner of Lot 3414, Kootenay Land District; thence north 25 degrees east 940 metres, more or less, to the westerly boundary of the watershed of Holdich Creek; thence in a general northerly and easterly direction along the westerly and northerly boundaries of the watershed of said Holdich Creek to the southwesterly boundary of the watershed of Downie Creek; thence in a general southeasterly, easterly and northerly direction along the southwesterly, southerly and easterly boundaries of the watershed of said Downie Creek to the easterly boundary of the watershed of Goldstream River; thence in a general northerly direction along easterly boundary of the watershed of said Goldstream River to the southerly boundary of the watershed of Stitt Creek; thence in a general westerly direction along the southerly boundary of the watershed of said Stitt Creek to a point 3.480 kilometres east and 220 metres south of the southeast corner of Lot 16941; thence south 60 degrees west 280 metres, more or less, to the natural boundary of an unnamed creek on the left bank thereof, said unnamed creek flowing southerly into aforesaid Goldstream River at a point 3.090 kilometres east and 2.200 kilometres south of the

southeast corner of aforesaid Lot 16941; thence in a general southerly direction along the natural boundary of said unnamed creek on the left bank thereof to the natural boundary of said Goldstream River on the right bank thereof; thence in a general westerly direction along the natural boundary of said Goldstream River on the right bank thereof to the easterly boundary of Section 24, Township 2, Kootenay Land District; thence southerly along the easterly boundary of said Section 24 to the southeast corner thereof; thence westerly along the southerly boundaries of Sections 24 and 23 to the northeast corner of Section 14; thence southerly along the easterly boundaries of Sections 14, 11 and 2, and Lot 80A to the most northerly corner of Lot 4685; thence southeasterly and southwesterly along the northeasterly and southeasterly boundaries of said Lot 4685 to the easterly boundary of said Lot 80A; thence southerly and westerly along the easterly and southerly boundaries of said Lot 80A to the natural boundary of aforesaid Revelstoke Lake on the easterly shore thereof; thence in a general southerly direction along the natural boundary of said Revelstoke Lake on the easterly shore thereof to a point due west of a tie point, said tie point being 6.172 kilometres north and 1.658 kilometres west of the northwest corner of Lot 8296; thence east to said tie point; thence south 805 metres; thence east 402 metres; thence south 1.207 kilometres; thence east 402 metres; thence south 805 metres; thence due west to the natural boundary of aforesaid Revelstoke Lake on the easterly shore thereof; thence in a general southerly direction along the natural boundary of said Revelstoke Lake on the easterly shore thereof to a point due west of a tie point, said tie point being 1.195 kilometres east and 787 metres south of the southwest corner of aforesaid Lot 8296; thence east to said tie point; thence south 402 metres; thence due west to the natural boundary of aforesaid Revelstoke Lake on the easterly shore thereof; thence in a general southerly direction along the natural boundary of said Revelstoke Lake on the easterly shore thereof to the northerly boundary of Lot 2772; thence easterly along the northerly boundary of said Lot 2772 to the southwest corner of Block A of Lot 2712; thence northerly, easterly and southerly along the westerly, northerly and easterly

boundaries of Block A of said Lot 2712 to the northerly boundary of aforesaid Lot 2772; thence easterly along the northerly boundary of said Lot 2772 to the natural boundary of Downie Arm on the northerly shore thereof; thence in a general northeasterly and southwesterly direction along the natural boundary of said Downie Arm on the northwesterly and southeasterly shores thereof to the easterly boundary of Lot 1880; thence southerly along the easterly boundary of said Lot 1880 to the natural boundary of aforesaid Revelstoke Lake on the easterly shore thereof; thence in a general southerly direction along the natural boundary of said Revelstoke Lake on the easterly shore thereof to the second most northerly boundary of Lot 2771; thence easterly and southerly along the northerly and easterly boundaries of said Lot 2771 to the northerly boundary of Lot 2774; thence easterly, southerly and westerly along the northerly, easterly and southerly boundaries of said Lot 2774 to the natural boundary of said Revelstoke Lake on the easterly shore thereof; thence in a general southeasterly direction along the natural boundary of said Revelstoke Lake on the easterly shore thereof to the northerly boundary of Lot 3414; thence easterly and southerly along the northerly and easterly boundaries of said Lot 3414 to the natural boundary of aforesaid Revelstoke Lake on the easterly shore thereof; thence in a general southeasterly direction along the natural boundary of said Revelstoke Lake on the easterly shore thereof to the natural boundary of aforesaid Cap Creek on the left bank thereof, being the point of commencement.

Excluding thereout all of that foreshore and land covered by water within the above described area, and lands that were deleted by notice or amendment under Tree Farm Licence Number 23, namely:

1. Notice dated September 20, 1955, which deleted various surveyed lots within Kootenay Land District.
2. Amendment No. 2, which deleted Lot 7486, Kootenay Land District.
3. Amendment No. 73, replaces Amendment No. 63, removes radio site.

SCHEDULE C

SCHEDULE C - FELLING, BUCKING AND UTILIZATION SPECIFICATIONS

1.00 DEFINITIONS

- 1.01 In this Schedule, as exemplified by the diagrams attached to this Schedule,
- (a) "butt end" means the log end that was previously attached to the stump;
 - (b) "butt log" means the log cut from the portion of the tree that was previously attached to the stump;
 - (c) "diameter at stump height" means
 - (i) in the case of standing timber, the diameter of the tree (outside bark) measured at the point of the maximum stump height shown in the table attached to this Schedule, and
 - (ii) in the case of a butt log, the diameter (outside bark) at the butt end of the log; and
 - (d) "slab" means one of 2 or more parts of a log produced as a result of the log fracturing along its length;
 - (e) "stump height" means the height of the stump measured on the side of the stump adjacent to the highest ground;
 - (f) "top diameter" means the diameter (inside bark) at the narrowest end of the log;
 - (g) "top log" means any log that is not a butt log.

2.00 FELLING SPECIFICATIONS

- 2.01 Subject to paragraph 4.06 of the Licence, standing timber of the species detailed in Table 1 of this Schedule must be felled in accordance with the following specifications:
- (a) all timber meeting the minimum diameter at stump height shown for species in Table 1 must be felled; and
 - (b) unless otherwise authorized in writing by the District Manager, timber must be felled to a stump height that does not exceed the maximum stump height shown for that species in Table 1.

SCHEDULE C

3.00 BUCKING SPECIFICATIONS

- 3.01 Subject to paragraph 4.06 of this Licence, felled or dead-and-down timber of the species referred to in paragraph 2.01 must be bucked so as to maximize the volume of logs and slabs which
- (a) meet the utilization specifications referred to in Part 4.00 of this Schedule, and
 - (b) are of the species and grades specified as obligatory utilization under Part 5.00 of this Schedule.

4.00 UTILIZATION SPECIFICATIONS

- 4.01 Subject to paragraph 4.02 of this Schedule and paragraph 4.06 of the Licence, the following utilization specifications apply to timber authorized for harvest under the Licence:
- (a) all butt logs meeting
 - (i) the minimum diameter at stump height,
 - (ii) the minimum log length,
 - (iii) the minimum top diameter, and
 - (b) all top logs meeting
 - (i) the minimum log length,
 - (ii) the minimum top diameter, and
 - (c) all slabs meeting
 - (i) the minimum slab length, and
 - (ii) the minimum slab thickness
- shown for that species in Table 2 attached to this Schedule must be utilized.
- 4.02 The Licensee need not utilize timber of the species and grades specified in Part 6.00 of this Schedule as optional utilization.

5.00 OBLIGATORY UTILIZATION

- 5.01 If a cutting permit or road permit specifies that the stand is endemic, then timber of the following species and grades are specified as obligatory utilization:
- (a) all coniferous species that are:
 - (i) Sawlog Grade (Grade Code Blank); and

SCHEDULE C

- (ii) Lumber Reject (Grade Code 4)

5.02 If a cutting permit or road permit specifies that the stand is catastrophic, then timber of the following species and grades are specified as obligatory utilization:

- (a) all coniferous species that are
 - (i) Sawlog Grade (Grade Code Blank),
 - (ii) Lumber Reject (Grade Code 4); and
 - (iii) Dead and Dry Sawlog (Grade Code 3).

6.00 OPTIONAL UTILIZATION

6.01 If a cutting permit or road permit specifies that the stand is endemic, then timber of the following species and grades are specified as optional utilization:

- (a) firmwood rejects;
- (b) all deciduous species of all grades; and
- (c) all coniferous species of the following grades:
 - (i) Dead and Dry Sawlog (Grade Code 3);
 - (ii) Dead and Dry Lumber Reject (Grade Code 5); and
 - (iii) Undersized Log Grade (Grade Code 6).

6.02 If a cutting permit or road permit specifies that the stand is catastrophic, then timber of the following species and grades are specified as optional utilization:

- (a) firmwood rejects;
- (b) all deciduous species of all grades; and
- (c) all coniferous species of the following grades:
 - (i) Dead and Dry Lumber Reject (Grade Code 5); and
 - (ii) Undersized Log Grade (Grade Code 6).

SCHEDULE C

Diagram 1. Felling Specifications

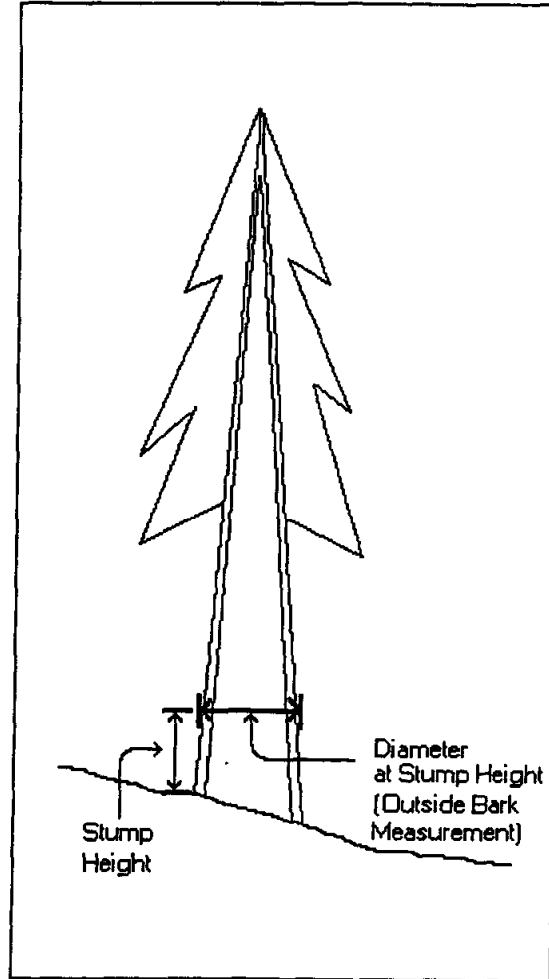

Table 1

Species	Maximum Stump Height	Minimum Diameter at Stump Height
Lodgepole pine	30.0 cm	15.0 cm
All other species	30.0 cm	20.0 cm

SCHEDULE C

Diagram 2. Utilization Specifications

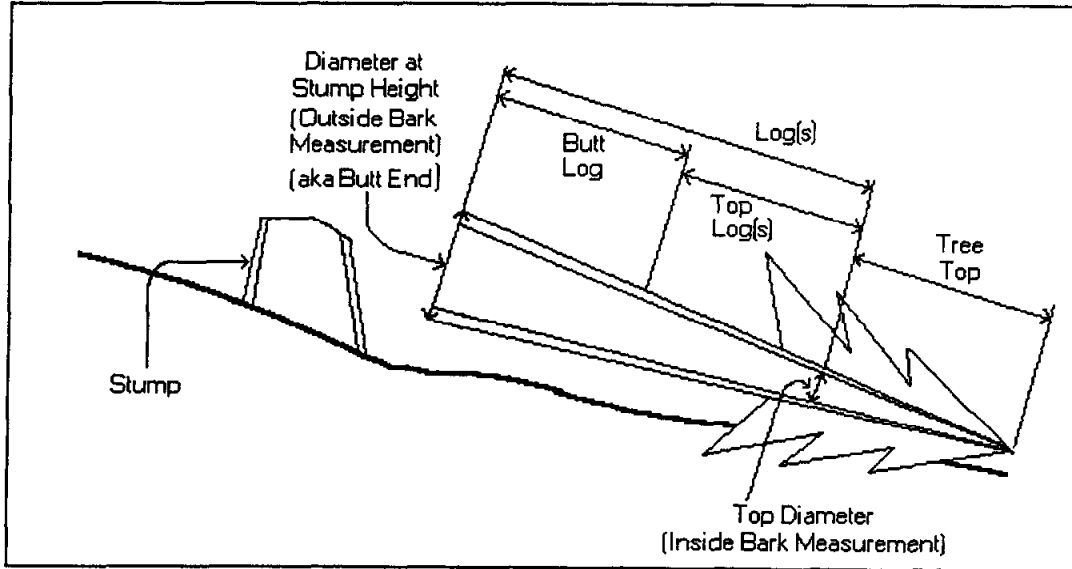

Table 2

Species	Minimum Log or Slab Length	Minimum Diameter at Stump Height	Minimum Top Diameter or Slab Thickness
Lodgepole pine	3.0 m	15.0 cm	10.0 cm
Cedar older than 141 years	3.0 m	20.0 cm	15.0 cm
All other species and ages	3.0 m	20.0 cm	10.0 cm

SCHEDULE D

SCHEDULE D - 2.00 MANAGEMENT PLANS

2.01 A management plan

- (a) approved under the tree farm licence replaced by the Licence, and
- (b) still in effect on the date immediately preceding the date referred to in paragraph 1.01 of the Licence,

is deemed for the remainder of the term of the management plan to be the management plan in effect under the Licence.

2.02 If there is no approved management plan in effect under the tree farm licence replaced by the Licence on the date immediately preceding the date referred to in paragraph 1.01 of the Licence, then solely for the purposes of

- (a) inviting comments under paragraph 2.05(a) and providing an assessment under paragraph 2.08(a), and
- (b) determining the deadlines for
 - (i) inviting comments under subparagraph 2.05(a),
 - (ii) submitting a review strategy under subparagraph 2.05(b),
 - (iii) providing an assessment under clause 2.08(a)(i),
 - (iv) submitting a summary of comments under subparagraph 2.08(b),
 - (v) submitting a Statement of Management Objectives, Options and Procedures under paragraph 2.09,
 - (vi) referring a draft management plan and inviting comments under paragraph 2.24, and
 - (vii) submitting a proposed management plan under paragraph 2.26,

the parties will proceed as if the management plan which was last in effect under that tree farm licence is the management plan in effect under the Licence and, subject to paragraph 2.04, is due to expire 28 months after the date referred to in paragraph 1.01 of the Licence.

2.03 If the management plan deemed under paragraph 2.01 to be the management plan in effect under the Licence is due to expire less than 28 months after the date referred to in paragraph 1.01 of the Licence of the Licence, then solely for the purpose of determining the deadlines for

- (a) inviting comments under subparagraph 2.05(a),
- (b) submitting a review strategy under subparagraph 2.05(b), if applicable,

SCHEDULE D

- (c) providing an assessment under clause 2.08(a)(i),
- (d) submitting a summary of comments under subparagraph 2.08(b),
- (e) submitting a Statement of Management Objectives, Options and Procedures under paragraph 2.09,
- (f) referring a draft management plan and inviting comments under paragraph 2.24, and
- (g) submitting a proposed management plan under paragraph 2.26,

the parties will proceed as if, subject to paragraph 2.04, the management plan in effect under the Licence is due to expire 28 months after the date referred to in paragraph 1.01.

2.04 If

- (a) either
 - (i) there is no approved management plan in effect under the tree farm licence replaced by the Licence on the date immediately preceding the date referred to in paragraph 1.01 of the Licence, or
 - (ii) the management plan deemed under paragraph 2.01 to be the management plan in effect under the Licence is due to expire less than 28 months after the date referred to in paragraph 1.01 of the Licence, and
- (b) the Chief Forester is satisfied that a requirement or obligation referred to in this Part has been met or fulfilled under the tree farm licence replaced by the Licence,

the Chief Forester, in a notice given to the Licensee, may

- (c) specify the requirement or obligation that has been met or fulfilled and deem that requirement or obligation to have been met or fulfilled under the Licence, and
- (d) if a period of less than 28 months is sufficient for the purpose of establishing a deadline referred to in subparagraph 2.02(b) or paragraph 2.03, specify a period of less than 28 months which is sufficient for this purpose.

2.05 Not less than 28 months prior to the date on which the management plan in effect under the Licence is due to expire,

- (a) the Licensee will

SCHEDULE D

- (i) publish at least twice within a period of two consecutive weeks in a newspaper acceptable to the Regional Manager, an advertisement inviting comments regarding
 - (A) the management plan in effect under the Licence, and
 - (B) the Licensee's performance in respect of that management plan, and
- (ii) make a copy of the management plan in effect under the Licence available for review by interested persons
 - (A) during normal business hours, and
 - (B) at the Licensee's place of business in the vicinity of the Licence Area or, if the Licensee so chooses, at another location which is convenient to the public and acceptable to the Regional Manager, for a period of one month, or longer if the Licensee so chooses, beginning at least one week after the last publication of the advertisement referred to in clause (i), and
- (b) if there is no management plan in effect under the Licence, or if the management plan in effect under the Licence does not include a review strategy for
 - (i) the Statement of Management Objectives, Options and Procedures referred to in paragraph 2.09,
 - (ii) the draft management plan referred to in paragraph 2.24,
 - (iii) the statement of objectives referred to in paragraph 2.41, or
 - (iv) the statement of proposals referred to in paragraph 2.42,

the Licensee will submit to the Regional Manager a review strategy, complying with the requirements of paragraphs 2.44, 2.45, 2.46, 2.47, and 2.48, for the Statement of Management Objectives, Options and Procedures, the draft management plan, the statement of objectives referred to in paragraph 2.41, and the statement of proposals referred to in paragraph 2.42, as applicable.

2.06 The Regional Manager, within two months after the date on which the Regional Manager receives a review strategy submitted under subparagraph 2.05(b) or 2.07(b), will in a notice given to the Licensee approve the review strategy, subject to such conditions as the Regional Manager considers necessary or appropriate, if the Regional Manager is satisfied that the review strategy meets the requirements of paragraphs 2.44, 2.45, 2.46, 2.47, and 2.48.

2.07 Where the Regional Manager does not approve a review strategy under paragraph 2.06,

SCHEDULE D

- (a) the Regional Manager, within two months after the date on which the Regional Manager receives the review strategy, will specify in a notice given to the Licensee why the Regional Manager has not approved the review strategy, and
 - (b) the Licensee, within one month after the date on which the Licensee is given the notice referred to in subparagraph (a), will submit a new or revised review strategy to the Regional Manager.
- 2.08 Not less than 26 months prior to the date on which the management plan in effect under the Licence is due to expire,
 - (a) the Regional Manager will provide the Licensee with
 - (i) an assessment of
 - (A) the management plan in effect under the Licence, and
 - (B) the Licensee's performance in respect of that management plan, and
 - (ii) a list of guidelines currently in effect, and
 - (b) the Licensee will submit to the Regional Manager a summary of the comments received by the Licensee in complying with subparagraph 2.05(a).
- 2.09 The Licensee, not less than 22 months prior to the date on which the management plan in effect under the Licence is due to expire, will submit to the Regional Manager
 - (a) a Statement of Management Objectives, Options and Procedures which has been referred to resource agencies and made available for comment in accordance with the review strategy approved
 - (i) in the management plan in effect under the Licence, or
 - (ii) under paragraph 2.06,as the case may be, and
 - (b) a summary of
 - (i) all comments received by the Licensee in complying with the review strategy referred to in subparagraph (a), and
 - (ii) the modifications, if any, made to the Statement of Management Objectives, Options and Procedures, prior to its submission to the Regional Manager, in response to the comments referred to in clause (i).
- 2.10 A Statement of Management Objectives, Options and Procedures submitted under paragraph 2.09 or subparagraph 2.12(b) must

SCHEDULE D

- (a) be prepared by a professional forester in accordance with the applicable manual in effect four months prior to the deadline for submitting the Statement of Management Objectives, Options and Procedures under paragraph 2.09 or subparagraph 2.12(b), as the case may be,
- (b) summarize the commitments which
 - (i) were made by the Licensee
 - (A) in the application on which the award of the tree farm licence replaced by the Licence or any predecessor to that tree farm licence was based,
 - (B) in accepting the offer of the tree farm licence replaced by the Licence or any predecessor to that tree farm licence, or
 - (C) as a result of a request for the Minister's consent for the purposes of Section 54 of the *Forest Act*, and
 - (ii) remain in effect at the time the Statement of Management Objectives, Options and Procedures is submitted,
- (c) identify the inadequacies, if any, in the information to be included in the inventories referred to in subparagraph 2.25(d),
- (d) propose management objectives for the Licence Area reflecting the management objectives which the Licensee intends to include in the draft management plan, and identify management options reflecting the proposals for meeting these objectives which the Licensee also intends to include in the draft management plan, regarding
 - (i) management and utilization of the timber resources in the Licence Area, including harvesting methods and felling, bucking and utilization specifications suitable to the types of timber and terrain specified in paragraphs 1.03 and 1.04 of the Licence,
 - (ii) protection and conservation of the non-timber values and resources in the Licence Area, including visual quality, biological diversity, soils, water, recreation resources, cultural heritage resources, range land, and wildlife and fish habitats,
 - (iii) integration of harvesting activities in the Licence Area with use of the Licence Area for purposes other than timber production, including use of the Licence Area by
 - (A) trappers, guide outfitters, range tenure holders, and other licensed resource users, and
 - (B) aboriginal people claiming an aboriginal interest in or to the area ,

SCHEDULE D

- (iv) forest fire prevention and suppression, prescribed fire, and fuel management,
- (v) forest health, including disease and pest management,
- (vi) silviculture,
- (vii) road construction, maintenance and deactivation, and
- (viii) any issues identified
 - (A) by the Licensee,
 - (B) by the Regional Manager in the assessment referred to in clause 2.08(a)(i), or
 - (C) in the comments referred to in subparagraph 2.08(b),

which are consistent with the Licence, higher level plans, the guidelines referred to in clause 2.08(a)(ii), and the commitments referred to in subparagraph (b),

- (e) identify inadequacies referred to in subparagraph (c) and issues referred to in clause (d)(viii) which will require further study or analysis, and indicate what, if any, studies or analyses the Licensee will carry out,
- (f) identify issues referred to in clause (d)(viii) which will be addressed in the management objectives and proposals in the draft management plan referred to in paragraph 2.24 and proposed management plan referred to in paragraph 2.26, and
- (g) identify management options referred to in subparagraph (d) which the Licensee proposes to assess in the timber supply analysis referred to in subparagraph 2.17(a).

2.11 The Regional Manager, within three months after the date on which the Regional Manager receives a Statement of Management Objectives, Options and Procedures submitted under paragraph 2.09, or two months after the date on which the Regional Manager receives a Statement of Management Objectives, Options and Procedures submitted under subparagraph 2.12(b), will in a notice given to the Licensee accept the Statement of Management Objectives, Options and Procedures, subject to such conditions as the Regional Manager considers necessary or appropriate, if

- (a) the Statement of Management Objectives, Options and Procedures meets the requirements of paragraph 2.10, and
- (b) the Regional Manager is satisfied that the Licensee has

SCHEDULE D

- (i) adequately addressed the inadequacies referred to in subparagraph 2.10(c), the issues referred to in clause 2.10(d)(viii), and the comments referred to in clause 2.09(b)(i), and
 - (ii) selected appropriate management options for assessment in the timber supply analysis.
- 2.12 Where the Regional Manager does not accept a Statement of Management Objectives, Options and Procedures under paragraph 2.11,
 - (a) the Regional Manager, within three months after the date on which the Regional Manager receives a Statement of Management Objectives, Options and Procedures submitted under paragraph 2.09, or two months after the date on which the Regional Manager receives a Statement of Management Objectives, Options and Procedures submitted under subparagraph (b), will specify in a notice given to the Licensee why the Regional Manager has not accepted the Statement of Management Objectives, Options and Procedures, and
 - (b) the Licensee, within one month after the date on which the Licensee is given the notice referred to in subparagraph (a), will submit a new or revised Statement of Management Objectives, Options and Procedures to the Regional Manager.
- 2.13 Where the Regional Manager accepts a Statement of Management Objectives, Options and Procedures under paragraph 2.11, the Licensee, within three months after the date on which the Statement of Management Objectives, Options and Procedures is accepted, will submit a Timber Supply Analysis Information Package to the Timber Supply Forester.
- 2.14 A Timber Supply Analysis Information Package submitted under paragraph 2.13 must
 - (a) include the information required in the applicable manual in effect six months prior to the deadline for submitting the Timber Supply Analysis Information Package,
 - (b) identify assumptions the Licensee proposes to incorporate into the timber supply analysis referred to in subparagraph 2.17(a) which are consistent with
 - (i) the Licence,
 - (ii) the Acts, regulations and standards referred to in paragraph 9.01 of the Licence,
 - (iii) higher level plans,

SCHEDULE D

- (iv) subject to paragraph 2.33, the guidelines referred to in clause 2.08(a)(ii),
 - (v) subject to paragraph 2.33, the management objectives in the Statement of Management Objectives, Options and Procedures accepted under paragraph 2.11, and
 - (vi) subject to paragraph 2.33, the management options in the Statement of Management Objectives, Options and Procedures accepted under paragraph 2.11 which are referred to in subparagraph 2.10(g),
- (c) without restricting the generality of subparagraph (b), identify assumptions the Licensee proposes to incorporate into the timber supply analysis referred to in subparagraph 2.17(a) regarding
- (i) the inventory of timber and non-timber resources in the Licence Area,
 - (ii) growth and yield,
 - (iii) regeneration delays,
 - (iv) silviculture treatments,
 - (v) integrated resource management constraints,
 - (vi) harvesting methods and felling, bucking and utilization specifications, and
 - (vii) the timber harvesting land base,
- (d) describe the methodology, including the computer model, if any, that the Licensee proposes to use in the timber supply analysis, including a description of the extent to which the assumptions referred to in subparagraphs (b) and (c) are reflected in the methodology,
- (e) include information which supports the assumptions referred to in subparagraphs (b), (c) and (d),
- (f) describe how the Licensee proposes to address in the timber supply analysis any inadequacies referred to in subparagraph 2.10(c), and
- (g) include any other information readily available to the Licensee, which
- (i) the Licensee, or
 - (ii) the Timber Supply Forester, in a notice given to the Licensee within one month after the date on which the Licensee is given the notice accepting the Statement of Management Objective, Options and Procedures under paragraph 2.11,
- considers relevant to an assessment of the impact on the timber supply of the management options referred to subparagraph 2.10(g).

SCHEDULE D

- 2.15 The Timber Supply Forester, within three months after the date on which the Timber Supply Forester receives the Timber Supply Analysis Information Package submitted under paragraph 2.13, or two months after the date on which the Timber Supply Forester receives the information or proposals submitted under subparagraph 2.16(b), will in a notice given to the Licensee accept the assumptions and the methodology referred to in paragraph 2.14 and, if applicable, subparagraph 2.16(b) for use in the timber supply analysis referred to in subparagraph 2.17(a), subject to such conditions as the Timber Supply Forester considers necessary or appropriate, if
- (a) the requirements of paragraph 2.14 and, if applicable, subparagraph 2.16(b) have been met, and
 - (b) the Timber Supply Forester is satisfied with the information provided in support of the assumptions and methodology.
- 2.16 Where the Timber Supply Forester does not accept both the assumptions and the methodology under paragraph 2.15,
- (a) the Timber Supply Forester, within three months after the date on which the Timber Supply Forester receives the Timber Supply Analysis Information Package submitted under paragraph 2.13, or two months after the date on which the Timber Supply Forester receives the information or proposals submitted under subparagraph (b), will specify in a notice given to the Licensee why the Timber Supply Forester has not accepted the assumptions, the methodology or both, and
 - (b) the Licensee, within one month after the date on which the Licensee is given the notice referred to in subparagraph (a), will
 - (i) propose new or revised assumptions,
 - (ii) propose a new or revised methodology, and
 - (iii) submit further information in support of the assumptions, the methodology or both,as required by the Timber Supply Forester.
- 2.17 Where the Timber Supply Forester accepts the assumptions and the methodology under paragraph 2.15, the Licensee, within three months after the date on which the assumptions and the methodology are accepted, will submit
- (a) a timber supply analysis to the Timber Supply Forester, and

SCHEDULE D

- (b) a 20-year plan to the District Manager.
- 2.18 A timber supply analysis submitted under subparagraphs 2.17(a) or 2.22(b) must:
 - (a) assess the impact on the timber supply of the management options in the Statement of Management Objectives, Options and Procedures accepted under paragraph 2.11 which are referred to in subparagraph 2.10(g), and
 - (b) subject to paragraph 2.33,
 - (i) be based on the assumptions, and
 - (ii) use the methodology,accepted by the Timber Supply Forester under paragraph 2.15.
- 2.19 A 20-year plan submitted under subparagraph 2.17(b) or 2.23(b) must
 - (a) identify
 - (i) the timber harvesting land base,
 - (ii) harvested areas,
 - (iii) existing and proposed road access within the timber harvesting land base, and
 - (iv) areas subject to special integrated resource management constraints, such as use of the Licence Area for purposes other than timber production,
 - (b) categorize areas within the timber harvesting land base referred to in clause (a)(i) by
 - (i) the type and quality of timber, and
 - (ii) the harvesting methods suitable to the terrain, and
 - (c) in support of the timber supply analysis, set out a hypothetical sequence of cut blocks in 5 year increments over a period of 20 years, or longer if the Licensee so chooses, which is consistent with
 - (i) the Licence,
 - (ii) the Acts, regulations and standards referred to in paragraph 9.01 of the Licence,
 - (iii) higher level plans,
 - (iv) subject to paragraph 2.33, the guidelines referred to in clause 2.08(a)(ii),
 - (v) subject to paragraph 2.33, the management objectives in the Statement of Management Objectives, Options and Procedures accepted under paragraph 2.11, and

SCHEDULE D

- (vi) subject to paragraph 2.33, a management option selected by the Licensee from the management options in the Statement of Management Objectives, Options and Procedures accepted under paragraph 2.11 which are referred to in subparagraph 2.10(g).
- 2.20 The Timber Supply Forester, within three months after the date on which the Timber Supply Forester receives a timber supply analysis submitted under subparagraph 2.17(a), or two months after the date the Timber Supply Forester receives a timber supply analysis submitted under subparagraph 2.22(b), will
 - (a) in a notice given to the Licensee accept the timber supply analysis, subject to such conditions as the Timber Supply Forester considers necessary or appropriate, if the timber supply analysis meets the requirements of paragraph 2.18, and
 - (b) where the Timber Supply Forester accepts the timber supply analysis under subparagraph (a), provide the Licensee with an assessment of the strengths and weaknesses of the timber supply analysis.
- 2.21 The District Manager, within three months after the date on which the District Manager receives a 20-year plan submitted under subparagraph 2.17(b), or two months after the date on which the District Manager receives a 20-year plan submitted under subparagraph 2.23(b), will
 - (a) in a notice given to the Licensee accept the 20-year plan, subject to such conditions as the District Manager considers necessary or appropriate, if the 20-year plan meets the requirements of paragraph 2.19, and
 - (b) where the District Manager accepts the 20-year plan under subparagraph (a), provide the Licensee with an assessment of the strengths and weaknesses of the 20-year plan.
- 2.22 Where the Timber Supply Forester does not accept a timber supply analysis under paragraph 2.20,
 - (a) the Timber Supply Forester, within three months after the date on which the Timber Supply Forester receives a timber supply analysis submitted under subparagraph 2.17(a), or two months after the date on which the Timber Supply Forester receives a timber supply analysis submitted under subparagraph (b), will specify in a notice given to the Licensee why the Timber Supply Forester has not accepted the timber supply analysis, and

SCHEDULE D

- (b) the Licensee, within one month after the date on which the Licensee is given the notice referred to in subparagraph (a), will submit a new or revised timber supply analysis to the Timber Supply Forester.
- 2.23 Where the District Manager does not accept a 20-year plan under paragraph 2.21,
 - (a) the District Manager, within three months after the date on which the District Manager receives a 20-year plan submitted under subparagraph 2.17(b), or two months after the date on which the District Manager receives a 20-year plan submitted under subparagraph (b), will specify in a notice given to the Licensee why the District Manager has not accepted the 20-year plan, and
 - (b) the Licensee, within one month after the date on which the Licensee is given the notice referred to in subparagraph (a), will submit a new or revised 20-year plan to the District Manager.
- 2.24 Not less than six months prior to the date on which the management plan in effect under the Licence is due to expire, the Licensee will
 - (a) refer a draft management plan to the Regional Manager for comment, and
 - (b) at the same time, refer the draft management plan referred to in subparagraph (a) to resource agencies and make it available for comment in accordance with the review strategy approved
 - (i) in the management plan in effect under the Licence, or
 - (ii) under paragraph 2.06,

as the case may be.
- 2.25 A draft management plan referred to in paragraph 2.24 or subparagraph 2.37(a) and a proposed management plan submitted by the Licensee under paragraph 2.26, subparagraph 2.30(b) or 2.37(b) must
 - (a) be prepared by a professional forester in accordance with the applicable manual in effect four months prior to the deadline for submitting the draft management plan under paragraph 2.24 or subparagraph 2.37(a), as the case may be,
 - (b) be signed and sealed by the professional forester who prepared it, and signed by the Licensee or an authorized signatory of the Licensee,
 - (c) be consistent with
 - (i) the Licence,

SCHEDULE D

- (ii) the Acts, regulations and standards referred to in paragraph 9.01 of the Licence,
 - (iii) higher level plans,
 - (iv) the commitments referred to in subparagraph 2.10(b),
 - (v) subject to paragraph 2.33, the guidelines referred to in clause 2.08(a)(ii),
 - (vi) subject to paragraph 2.33, the Statement of Management Objectives, Options and Procedures accepted under paragraph 2.11,
- (d) include inventories, prepared in the manner, presented in the format and meeting the specifications set or approved in the applicable manual in effect six months prior to the deadline for submitting the Timber Supply Analysis Information Package, of the forest, recreation, fisheries, wildlife, range, and cultural heritage resources in the Licence Area, including information relating to visual quality objectives, sensitive soils, recreation sites, and the type of timber and terrain,
- (e) include proposals for updating the inventories referred to in subparagraph (d) and, if applicable, addressing inadequacies in the inventory information,
- (f) propose management objectives regarding
- (i) management and utilization of the timber resources in the Licence Area, including harvesting methods and felling, bucking and utilization specifications suitable to the types of timber and terrain specified in paragraphs 1.03 and 1.04 of the Licence,
 - (ii) protection and conservation of the non-timber values and resources in the Licence Area, including visual quality, biological diversity, soils, water, recreation resources, cultural heritage resources, range land, and wildlife and fish habitats,
 - (iii) integration of harvesting activities in the Licence Area with use of the Licence Area for purposes other than timber production, including use of the Licence Area by
 - (A) trappers, guide outfitters, range tenure holders, and other licensed resource users, and
 - (B) aboriginal people claiming an aboriginal interest in or to the area ,
 - (iv) forest fire prevention and suppression, prescribed fire, and fuel management,
 - (v) forest health, including disease and pest management,
 - (vi) silviculture,

SCHEDULE D

- (vii) road construction, maintenance and deactivation, and
- (viii) anything else relating to the management, development and use of the Licence Area that the Chief Forester requires,
- (g) include proposals for meeting the proposed management objectives referred to in subparagraph (f), including measures to be taken and specifications to be followed by the Licensee which meet or, if the Licensee so chooses, exceeds any requirements of the Acts, regulations and standards referred to in paragraph 9.01 of the Licence, or of the higher level plans or guidelines referred to in subparagraph (c),
- (h) specify measures to be taken by the Licensee to identify and consult with persons using the Licence Area for purposes other than timber production, including
 - (i) trappers, guide outfitters, range tenure holders, and other licensed resource users, and
 - (ii) aboriginal people claiming an aboriginal interest in or to the area,
- (i) include
 - (i) the Statement of Management Objectives, Options and Procedures accepted under paragraph 2.11, including revisions, if any, required under paragraph 2.33,
 - (ii) either
 - (A) the timber supply analysis accepted under paragraph 2.20, together with the assessment referred to in subparagraph 2.20(b), or
 - (B) where no timber supply analysis has been accepted, a draft timber supply analysis prefaced with a statement to the effect that the draft timber supply analysis has not been submitted under subparagraph 2.17(a) or accepted under paragraph 2.20, as applicable, and
 - (iii) either
 - (A) the 20-year plan accepted under paragraph 2.21, together with the assessment referred to in subparagraph 2.21(b), or
 - (B) where no 20-year plan has been accepted, a draft 20-year plan prefaced with a statement to the effect that the draft 20-year plan has been not submitted under subparagraph 2.17(b) or accepted under paragraph 2.21, as applicable,

SCHEDULE D

- (j) assess the impact the draft management plan or proposed management plan, as the case may be, will have on factors such as harvest levels, economic opportunities, the number of persons employed by the Licensee and contractors of the Licensee, and the protection and conservation of non-timber values,
- (k) highlight the key similarities and differences between the draft management plan or the proposed management plan, as the case may be, and the management plan in effect or last in effect under the Licence, and in a summary form compare
 - (i) the impact, if any, that implementation of the management plan in effect or last in effect under the Licence had, and
 - (ii) the impact, if any, that the Licensee anticipates implementation of the draft management plan or the proposed management plan, as the case may be, will have on factors such as those referred to in subparagraph (j),
- (l) if applicable, provide that part of the allowable annual cut will be harvested from a specified part of the Licence Area, or from a specified type of timber or terrain,
- (m) include any other information on the development, management and use of the Licence Area that the Chief Forester requires, and
- (n) if required in the manual referred to in subparagraph (a), provide some or all of the information referred to in this subparagraph in the form of maps meeting the requirements of the manual.

2.26 The Licensee, not less than three months prior to the date on which the management plan in effect under the Licence is due to expire, will submit to the Chief Forester

- (a) a proposed management plan which is based on the draft management plan referred to in paragraph 2.24, and
- (b) a summary of
 - (i) all comments
 - (A) provided by the Regional Manager within two months of the date on which the Regional Manager receives a draft management plan referred to the Regional Manager in accordance with the requirements of subparagraph 2.24(a), and
 - (B) received by the Licensee in complying with the requirements of subparagraph 2.24(b), and

SCHEDULE D

- (ii) the differences, if any, between the draft management plan and the proposed management plan, including differences resulting from modifications made in response to the comments referred to in clause (i).

2.27 Subject to paragraphs 2.28 and 2.29, the Chief Forester, within three months after the date on which the Chief Forester receives a proposed management plan submitted under paragraph 2.26, subparagraph 2.30(b) or 2.37(b), will in a notice given to the Licensee approve the proposed management plan, subject to such conditions as the Chief Forester considers necessary or appropriate, if

- (a) the Chief Forester is satisfied that the proposed management plan
 - (i) meets the requirements of paragraph 2.25 and subparagraph 2.26(a) or clause 2.37(b)(i), as the case may be, and
 - (ii) adequately addresses the comment referred to in clause 2.26(b)(i) or subclause 2.37(b)(ii)(A), as the case may be, and
- (b) the proposed management plan includes
 - (i) inventories referred to in subparagraph 2.25(d),
 - (ii) proposals referred to in subparagraph 2.25(e) for updating these inventories and, if applicable, addressing inadequacies in the inventory information,
 - (iii) management objectives referred to in subparagraph 2.25(f),
 - (iv) proposals referred to in subparagraph 2.25(g) for meeting these objectives, and
 - (v) measures referred to in subparagraph 2.25(h) for identifying and consulting with persons using the Licence Area for purposes other than timber production,

which are satisfactory to the Chief Forester.

2.28 The Chief Forester, in a notice given to the Licensee, may refuse to approve a proposed management plan under paragraph 2.27 until such time as

- (a) a timber supply analysis is accepted under paragraph 2.20, or
- (b) a 20-year plan is accepted under paragraph 2.21.

SCHEDULE D

- 2.29 Where a timber supply analysis accepted under paragraph 2.20 or a 20-year plan accepted under paragraph 2.21 was not included in the draft management plan referred to in paragraph 2.24, before approving a proposed management plan under paragraph 2.27, the Chief Forester, in a notice given to the Licensee, may require the Licensee to refer the timber supply analysis or the 20-year plan, as the case may be, and make it available for comment in accordance with the review strategy referred to in paragraph 2.24.
- 2.30 Where the Chief Forester does not approve a proposed management plan under paragraph 2.27,
- (a) subject to paragraphs 2.28 and 2.29, the Chief Forester, within three months after the date on which the Chief Forester receives the proposed management plan, will specify in a notice given to the Licensee why the Chief Forester has not approved the proposed management plan, and
 - (b) the Licensee, within one month after the date on which the Licensee is given the notice referred to in subparagraph (a), will submit a new or revised proposed management plan to the Chief Forester.
- 2.31 Subject to paragraphs 2.28 and 2.29, if
- (a) the Chief Forester, within three months after the date on which the Chief Forester receives a proposed management plan submitted under paragraph 2.26, has neither
 - (i) approved the proposed management plan under paragraph 2.27, nor
 - (ii) given the Licensee a notice referred to in subparagraph 2.30(a), and
 - (b) there is a management plan in effect under the Licence,
- then the term of the management plan referred to in subparagraph (b) is deemed to be extended until such time as the Chief Forester approves the proposed management plan under paragraph 2.27, or gives the Licensee a notice referred to in subparagraph 2.30(a), as the case may be.
- 2.32 If the Chief Forester is satisfied that the Licensee or a Ministry employee is trying in good faith to fulfill a requirement or obligation under this Part, but for reasons beyond the control of the Licensee or the Ministry employee, as the case may be, cannot
- (a) meet a deadline referred to in this Part, or

SCHEDULE D

- (b) where there is a management plan in effect under the Licence, fulfill the requirement or obligation before the management plan is due to expire,

then the Chief Forester, in a notice given to the Licensee, will, as applicable,

- (c) extend the deadline by a period the Chief Forester considers sufficient to allow the Ministry employee or the Licensee, as the case may be, to fulfill the requirement or obligation, or
- (d) extend the term of the management plan by a period the Chief Forester considers sufficient to allow the Ministry employee or the Licensee, as the case may be, to fulfill the requirement or obligation in accordance with applicable deadlines,

subject to such conditions as the Chief Forester considers necessary or appropriate.

2.33 If the Licensee

- (a) submits a Timber Supply Analysis Information Package under paragraph 2.13, or the information or proposals referred to in subparagraph 2.16(b) more than eight months,
- (b) submits a timber supply analysis under subparagraph 2.17(a) or 2.22(b), or a 20-year plan under subparagraph 2.17(b) or 2.23(b) more than 13 months,
- (c) submits a draft management plan under paragraph 2.24 more than 19 months, or
- (d) submits a proposed management plan under paragraph 2.26 or subparagraph 2.30(b) more than 22 months,

after the date on which the Statement of Management Objectives, Options and Procedures is accepted under paragraph 2.11, the Chief Forester, in a notice given to the Licensee within one month of the date on which the applicable item is submitted, may require the Licensee to amend both the Statement of Management Objectives, Options and Procedures, and one or more of the items referred to in subparagraph (a) through (d) inclusive, to the extent required to address any new issues that may have arisen and ensure consistency with

- (e) any new guidelines or manuals in effect on the date the Licensee is given the notice,
- (f) higher level plans, and

SCHEDULE D

(g) the Acts, regulations and standards referred to in paragraph 9.01 of the Licence

2.34 If the Chief Forester considers that

- (a) damage to timber in the Licence Area as a result of fire, flood, wind, insects, disease, or other causes,
- (b) a determination by the Chief Forester that operations conducted in accordance with the management plan are causing or could cause serious damage to the natural environment, including soils, fisheries, wildlife, water, range, and recreation resources,
- (c) establishment, variance, cancellation or replacement of a higher level plan,
- (d) interference with an aboriginal right,
- (e) a change in the allowable annual cut as a result of a determination by the Chief Forester under the *Forest Act*, or
- (f) other special circumstances,

have rendered the management plan in effect under the Licence inadequate, the Chief Forester, in a notice given to the Licensee, may require that the management plan be amended.

2.35 A notice referred to in paragraph 2.34 must specify

- (a) why the Chief Forester considers the management plan has been rendered inadequate,
- (b) the extent to which the management plan is inadequate, and
- (c) the changes required by the Chief Forester.

2.36 Where the Chief Forester gives the Licensee a notice referred to in paragraph 2.34, the Licensee, within three months after the date on which the notice is given, will submit for the Chief Forester's approval a proposed amendment to the management plan, which incorporates the changes referred to in subparagraph 2.35(c), to have effect during the unexpired term of the management plan.

2.37 If the Licensee fails to comply with the requirements of paragraph 2.36, the management plan in effect under the Licence will expire three months after the date on which the notice referred to in paragraph 2.34 is given to the Licensee, in which case,

- (a) within three months after the date on which the management plan expires under this subparagraph, the Licensee will

SCHEDULE D

- (i) refer a draft management plan to the Regional Manager and
 - (ii) at the same time, refer the draft management plan referred to in clause (i) to resource agencies and make it available for comment in accordance with the review strategy referred to in subparagraph 2.24(b), and
 - (b) within six months after the date on which the management plan expires under this paragraph, the Licensee will submit to the Chief Forester
 - (i) a proposed management plan which is based on the draft management plan referred to in subparagraph (a), and
 - (ii) a summary of
 - (A) all comments received by the Licensee in complying with the requirements of subparagraph (a), and
 - (B) the differences, if any, between the draft management plan and the proposed management plan, including differences resulting from modifications made in response to the comments referred to in subclause (A).
- 2.38 The Licensee will implement the management plan in effect under the Licence.
- 2.39 The management plan in effect under the Licence is deemed to be part of the Licence.
- 2.40 Subject to paragraphs 2.31, 2.32, and 2.37, a management plan expires five years after the date on which it takes effect.
- 2.41 When the Licensee submits a Statement of Management Objectives, Options and Procedures under paragraph 2.09, the Licensee will also submit to the Regional Manager
- (a) a statement of the Licensee's objectives regarding
 - (i) employment of people living in or near the Licence Area, including aboriginal people, and
 - (ii) economic opportunities available to people living in or near the Licence Area, including aboriginal people, in respect of timber harvested under the Licence or the Licensee's operations under or in respect of the Licence,
- which has been referred to resource agencies and made available for comment in accordance with the review strategy approved in the management plan in effect under the Licence, or under paragraph 2.06, as the case may be, and
- (b) a summary of

SCHEDULE D

- (i) all comments received by the Licensee in complying with the review strategy referred to in subparagraph (a), and
 - (ii) the modifications, if any, made to the statement of objectives prior to its submission to the Regional Manager, in response to the comments referred to in clause (i).
- 2.42 When the Licensee refers a draft management plan and makes it available for comment under paragraph 2.24, the Licensee will also refer and make available for comment, in accordance with the review strategy approved
 - (a) in the management plan in effect under the Licence, or
 - (b) under paragraph 2.06,as the case may be, a draft statement of the Licensee's proposals for meeting the objectives set out in the statement of objectives submitted under paragraph 2.41.
- 2.43 When the Licensee submits a proposed management plan to the Chief Forester under paragraph 2.26, the Licensee will also submit
 - (a) a statement of proposals based on the draft statement of proposals referred to in paragraph 2.42, and
 - (b) a summary of
 - (i) all comments received by the Licensee in complying with the requirements of paragraph 2.42, and
 - (ii) the differences, if any, between the statement of proposals submitted under this paragraph and the draft statement of proposals referred to in paragraph 2.42, including differences resulting from modifications made in response to the comments referred to in clause (i).
- 2.44 A review strategy referred to in subparagraphs 2.05(b) or 2.07(b) must
 - (a) provide adequate opportunities for comment to persons interested in or affected by operations under the Licence, including but not restricted to
 - (i) resource agencies,
 - (ii) trappers, guide outfitters, range tenure holders, and other licensed resource users,
 - (iii) aboriginal people,
 - (iv) local governments, and
 - (v) members of the public, and
 - (b) specify measures for inviting comment, including
 - (i) referrals to resource agencies,

SCHEDULE D

- (ii) advertising methods, times and locations,
 - (iii) viewing methods, times and locations,
 - (iv) if applicable, times and locations of open houses, and
 - (v) methods for collecting written and oral comments from interested persons.
- 2.45 An opportunity for comment provided to a person referred to in subparagraph 2.44(a) will only be adequate if, in the opinion of the Regional Manager or the Chief Forester, as the case may be, the opportunity for comment properly reflects the nature and extent of that person's interest in the Licence Area and any right that person may have to use the Licence Area.
- 2.46 When the Licensee refers a document or plan to resource agencies, or makes it available for comment, in accordance with an approved review strategy, the Licensee will at the same time send a copy of the document or plan to the Regional Manager for his or her information.
- 2.47 Before
 - (a) approving a review strategy under paragraph 2.06,
 - (b) accepting a Statement of Management Objectives, Options and Procedures under paragraph 2.11, or
 - (c) approving a proposed management plan under paragraph 2.27,the Regional Manager or the Chief Forester, as the case may be, at his or her sole discretion and notwithstanding the Licensee's obligations under the review strategy, may consult persons who may be interested in or affected by operations under or associated with the Licence, including but not restricted to
 - (d) resource agencies,
 - (e) trappers, guide outfitters, range tenure holders, and other licensed resource users,
 - (f) aboriginal people,
 - (g) local governments, and
 - (h) members of the public,and, subject to paragraph 2.48, may consider any comments received as a result of consultation under this paragraph.
- 2.48 If, because of comments received as a result of consultation under paragraph 2.47, the Regional Manager or the Chief Forester is considering

SCHEDULE D

- (a) not accepting or not approving, or
- (b) imposing a condition upon acceptance or approval of,

a document or plan referred to in paragraph 2.47, the Regional Manager or the Chief Forester, as the case may be, will provide the Licensee with an opportunity to respond to the comments before making a decision.

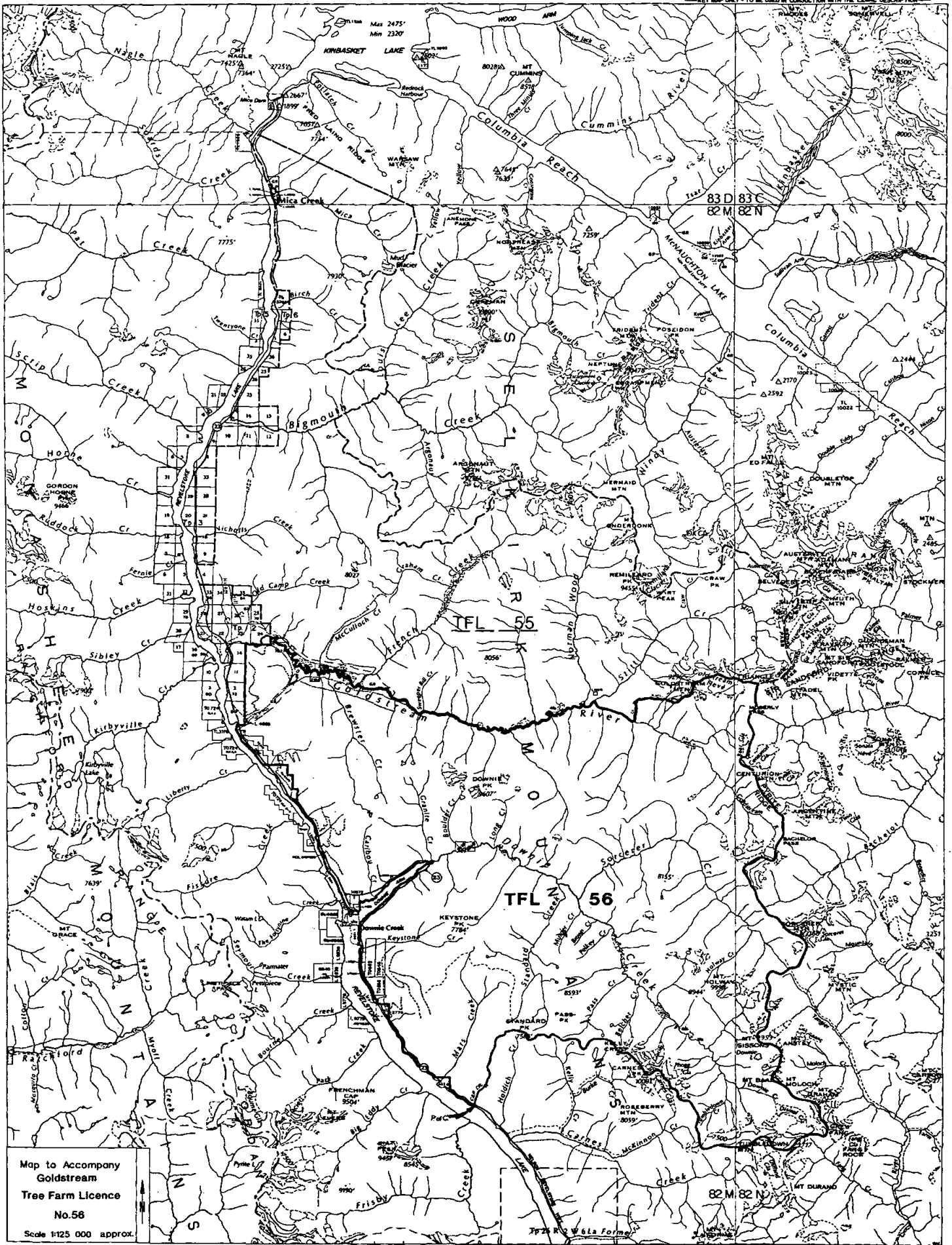

Map to Accompany
Goldstream
Tree Farm Licence
No. 56
Scale 1:25 000 approx.

NOTE: FLOODING OF NEVELSTONE LAKE BASED ON 128 000 INVENTORY (PINNAC) FOREST COVER MAP