

TIMBER PRICING BRANCH

Provincial Logging Residue and Waste Measurement Procedures Manual – Coast, Woodlot Licences, and Community Forest Agreements

Effective: April 1, 2019

Includes Amendments

Amendment No. 1

Amendment No. 2

Amendment No. 3

Effective Dates

May 1, 2019

December 23, 2019

April 1, 2021



This manual is intended for the use of individuals or companies when conducting business with the British Columbia Government.

Permission is granted to reproduce it for such purposes. This manual and related documentation and publications are protected under the *Federal Copyright Act*. They may not be reproduced for sale or for other purposes without the express written permission of the Province of British Columbia.

This page is intentionally left blank.

Amendment No. 3 - Provincial Logging Residue and Waste Procedures Manual - Coast, Woodlot Licences, and Community Forest Agreements Highlights

Section, Table or Appendix Number	Description
Throughout	Removed Pre-Harvest Waste Assessment procedures
Throughout	Minor wording changes
1.1	Removed Waste Assessment Policy and provided new link
1.2.3, 1.2.4	Added clarity on when waste submissions are required
1.2.6.1, 1.2.7	Updated monetary billings relative to the fibre recovery zone fraction
1.2.5	Reorganized definitions and added definition of “conventional”
1.6	Updated Waste Relief procedures
4.4.2	Update to procedure for determining plot location on roadside strata
5.3.2	Added submission requirements for waste assessment areas containing standing timber
5.3.2.2	Reorganized and updated submission and survey requirements
5.3.2.3	Updated wording when billing is required on unharvested cutblocks
5.7.2.1	Updated missing text in the harvest method table
7.4.1.2	Clarified Fibre Recovery Zone applicability and added FRZ adjustment factors
Table 7-1	Updated with new Obligation Adjustment values
Appendix 5	Updated benchmark selection criteria
Appendix 7	Updated the FRZ flow chart

Table of Contents

Introduction..... 4

Application.....4

To Obtain a Provincial Logging Residue andWaste Measurement Procedures Manual.....5

Comments and Suggestions.....5

Software Support5

1 Policy and Administration..... 1

1.1 Waste Assessment Policy2

1.2 Purpose and Rationale2

 1.2.1 Purpose2

 1.2.2 Rationale.....5

 1.2.3 Scale Based Cutting Authorities.....5

 1.2.4 Cruise Based Cutting Authorities5

 1.2.5 Definitions5

 1.2.6 Monetary Billings6

 1.2.7 Deciduous7

 1.2.8 Amount Payable.....7

1.3 Authority8

1.4 Background.....9

1.5 Responsibility11

 1.5.1 Timber Pricing Branch11

 1.5.2 Regional Manager.....11

 1.5.3 District Manager12

 1.5.4 Timber Sales Manager.....12

 1.5.5 Licensees13

1.6 Waste Relief Applications14

 1.6.1 Initiating an Application for Waste Relief.....14

 1.6.2 Processing of Application.....14

 1.6.3 Final Waste Relief Determination15

2 General Assessment Requirements 17

2.1	Field Assessments and Reporting Time Frames	2
2.2	Continuing Liability	3
2.3	Overdue Waste Assessments and Reports	4
2.4	Reporting Unit Options	5
2.4.1	Waste Assessment Area.....	5
2.4.2	Fibre Recovery Zone Cutblocks	5
2.4.3	Cutblock Option	6
2.4.4	Aggregate Option	6
2.4.5	Ocular Estimate Option	7
3	Alternative Methods	9
3.1	The RSI Method	2
3.1.1	RSI Method Procedures.....	2
3.2	Parent Block (PB) Method	4
3.2.1	Parent Block Method - Conditions	4
3.3	Ocular Estimate (OE) Method	5
3.3.1	Ocular Estimate Method – Best Field Practices	6
3.4	The OE Method and Standing Timber	8
4	Block Planning and Plot Layout	11
4.1	The Plot Sampling Process	12
4.2	Sampling Design	13
4.2.1	Population.....	13
4.2.2	Sub-Populations.....	13
4.2.3	Stratification	13
4.2.4	Block Survey Plan	14
4.2.5	Sampling Objective	14
4.3	Sampling Method	15
4.3.1	Number of Plots (Sample Size)	15
4.3.2	Procedure to Determine the Number of Plots.....	16
4.3.3	Grid Spacing	16
4.4	Plot Layout	17
4.4.1	Dispersed	17
4.4.2	Roadside Accumulations	19
4.4.3	Spot Accumulations.....	20
4.5	Stratification Procedures for Roadside Accumulations	21
4.5.1	Roadside Consisting of Strip Accumulations.....	21
4.5.2	Spot Accumulations Resulting From Piling Roadside Slash.....	21

4.5.3	Accumulations Within Dispersed Sub-population	21
4.5.4	Debuilt Road.....	21
4.6	Road Rights-of-Way.....	27
4.6.1	Reporting	27
4.6.2	Procedures	27
4.7	Partial Cutting (Variable Retention) Waste Assessment Areas.....	28
5	Field Procedures.....	29
5.1	General Requirements	9
5.1.1	Material to be Measured	9
5.1.2	Recording Standards.....	9
5.1.3	Waste Class.....	10
5.1.5	Grading Pieces	12
5.1.6	Visual Estimates	12
5.1.7	Measure Factor	12
5.1.8	Deductions for Rot.....	13
5.1.9	Waste Survey Safety Procedures	13
5.2	Plot Establishment.....	15
5.2.1	Locating Landing Plots.....	17
5.2.2	Locating Dispersed Plots	17
5.2.3	Moving Dispersed Plots.....	17
5.2.4	Plot Sizes	19
5.3	Kind of Material	21
5.3.1	Logs	21
5.3.2	Trees	21
5.3.3	Slabs	25
5.3.4	Stumps	26
5.3.5	Bucking Waste.....	30
5.3.6	Breakage.....	33
5.3.7	Forks	34
5.3.8	Long Butts	35
5.3.9	Coarse Woody Debris.....	35
5.3.10	Special Cases	35
5.4	Field Standards.....	36
5.4.1	Maps	36
5.4.2	Field Equipment and Supplies	36
5.4.3	Traverse Notes.....	37
5.5	Measurement Protocol and Standards	38
5.5.1	Lengths	38
5.5.2	Diameters.....	40
5.5.3	Bucking Waste.....	41
5.5.4	Deductions	41
5.6	Data Status and Recording Format	42

5.7	Completing the FS 444 (Block Summary Card)	38
5.7.1	Header.....	38
5.7.2	Area Statement	42
5.7.3	Timber Merchantability Specifications.....	47
5.8	Completion of the FS 161 (Plot Tally Card)	50
5.8.1	Header.....	50
5.8.2	Piece Descriptions	52
5.8.3	Gross ‘In Plot’ Dimensions for Pieces.....	54
5.8.4	Deduction for Rot or Holes.....	56
5.8.5	Outside Plot Measurements	57
6	Check Surveys	61
6.1	Check Surveys	62
6.2	Check Survey Standards	63
6.2.1	Number of Blocks.....	63
6.2.2	Check Requirements.....	64
6.3	Maximum Allowable Errors	65
6.3.1	Net Volume or Value.....	65
6.3.2	Individual Parameters	66
6.4	Acceptability of Block Results	67
6.5	Non-Compliance with Check Survey Standards	68
6.5.1	Second Check Survey	68
6.5.2	Dispute Resolution (BCTS).....	69
6.6	Material Disposed of Prior to Waste Assessments	70
7	Reporting	71
7.1	Data Compilation	72
7.2	Reporting Requirements	73
7.3	Review of Reports	6
7.3.1	Report Checklist	6
7.4	Processing Waste Volume Estimate (FS 702)	8
7.4.1	Waste Rate	8
7.5	Interior Log GradeChanges	12
Appendices	13	

Appendix 1 Glossary	2
A2.1 Standing Stem Harvesting	8
A2.2 Waste Accounting Methodology	8
Appendix 3 Waste Rate Determination.....	9
A3.1 Cutblocks with Harvesting.....	9
A3.2 Cutblocks with No Harvesting.....	9
A3.3 Coniferous Waste Rates Within a Fibre Recovery Zone	10
A3.4 Deciduous Waste Rate	10
Appendix 4 Riparian Management Zone (RMZ).....	11
A4.1 Assessment Method	11
A4.2 Stream Clean-out	11
Appendix 5 Waste Benchmarks	12
Appendix 6 Coast Grading.....	19
A6.1 Bucking Waste and Long Butts	19
A6.2 Stumps	19
A6.3 Logs	20
A6.4 Standing Trees	20
A6.5 Breakage	20
Appendix 7 Waste Benchmarks in the Coast Area and Fibre Recovery Zone (FRZ) Waste Rates.....	30

List of Figures

Figure 3-1 RW01 Estimate Form - Interior9
Figure 3-2 RW01 Estimate Form - Coast..... 10
Figure 4-1 Plot Sampling Process 12
Figure 4-2 Strip and Plot Placement..... 18
Figure 5-1 Measure Factor 13
Figure 5-2 Border Plot 18
Figure 5-3 Measuring Slabs 25
Figure 5-4 Avoidable and Unavoidable Waste (High Side) 27
Figure 5-5 Windfall Stump 29
Figure 5-6 Examples of Bucking Waste 31
Figure 5-7 Avoidable / Unavoidable Bucking Waste 32
Figure 5-8 Examples of Breakage 33
Figure 5-9 Forked Log 34
Figure 5-10 Measuring Broken Tops 38
Figure 5-11 Measuring Shattered Ends 39
Figure 5-12 Front of FS444 (Block Summary Card) 48
Figure 5-13 Back of FS 444 (Block Summary Card) 49
Figure 5-14 Front of the FS 161 (Plot Tally Card) 58
Figure 5-15 Back of the FS 161 (Plot Tally Card) 59
Figure 7-1 FS 702 - Volume Estimate - Waste Form (Page 1)..... 4
Figure 7-2 Volume Estimate - Waste Form (Page 2)..... 5
Figure 0-1 Sample of Worksheet for Waste Billing Against Benchmarks (Coast)..... 17
Figure 0-2 Sample of Worksheet for Waste Billing Against Benchmarks for Blocks..... 18

List of Tables

Table 1-1 Coast Timber Merchantability Specifications	2
Table 1-2 Interior Timber Merchantability Specifications	3
Table 1-3 The Disposition of Residue and Waste Volumes in Monetary Billing	4
Table 3-1 RSI Thresholds	2
Table 3-2 Ocular Estimate Thresholds	5
Table 4-1 Grid Spacing (GS) Worksheet	22
Table 4-2 Coast - Dispersed Area	23
Table 4-3 Coast - Accumulation Area	24
Table 4-4 Interior - Dispersed Area	25
Table 4-5 Interior - Accumulation Area	26
Table 5-1 Slope Distances for 11.28 m Plot Radius	16
Table 7-1 Timber Sales Licence Fibre Recovery Zone Obligation Adjustment Values by District	11

Introduction

In British Columbia, the right to harvest Crown timber is conferred through the form of agreements under the *Forest Act*. The *Forest Act* and the agreements require licensees to carry out waste assessments.

Waste assessments are carried out to quantify the volumes of merchantable timber and waste left on the harvested areas following the completion of primary logging. The waste volume data compiled from the assessments are used to invoice licensees for monetary and cut control charges.

This manual outlines the administration and field measurement procedures to be used in the assessments and is intended to serve as the reference for industry and government staff who conduct or check waste assessments in British Columbia.

Application

The manual is applicable to waste assessments:

- located in the Coast Area,
- located in the North Area or South Area authorized under a Community Forest Agreement, or
- located in the North Area or South Area authorized under a Woodlot Licence.

To Obtain a Provincial Logging Residue and Waste Measurement Procedures Manual

The manuals are available electronically on the Internet at:

<http://www2.gov.bc.ca/gov/content/industry/forestry/competitive-forest-industry/timber-pricing/forest-residue-waste/provincial-logging-residue-and-waste-measurements-procedure-manual>

Comments and Suggestions

Any comments on this manual can be sent to:

Provincial Residue and Log Salvage Policy Forester
Ministry of Forests, Lands, Natural Resource
Operations and Rural Development
Timber Pricing Branch
PO Box 9511 Stn Prov Govt
Victoria, BC V8W 9C2
E-mail: Forests.RevenueBranchOffice@gov.bc.ca

Software Support

To support the compilation of waste data, the Ministry of Forests, Lands Natural Resource Operations and Rural Development has made available the following software program which, together with the accompanying user guides, can be downloaded from the following internet web address:

<http://www2.gov.bc.ca/gov/content/industry/forestry/competitive-forest-industry/timber-pricing/forest-residue-waste>

1 Policy and Administration

1.1 Waste Assessment Policy

The Waste Assessment Policy can be found online at:

<https://www2.gov.bc.ca/gov/content/industry/forestry/competitive-forest-industry/timber-pricing/forest-residue-waste>

1.2 Purpose and Rationale

1.2.1 Purpose

Waste assessments are carried out to bill licensees monetarily for timber except reserved timber, whether standing or felled, that will not be removed from the cutting authority area and which meets or exceeds the timber merchantability specifications described below.

Table 1-1 Coast Timber Merchantability Specifications

Description		Mature*	Immature*
Stumps**			
•	no higher than	30 cm	30 cm
Top diameter (inside bark)			
•	all timber that meets or exceeds	15 cm	10 cm
Slab thickness:			
•	all slabs that meet or exceed (cedar only)	15 cm	10 cm
•	all slabs that meet or exceed (all other species)	10 cm	10 cm
Minimum length			
•	log or slab	3 m	3 m

* The selection of Mature or Immature is based on the determination of maturity in a timber cruise of the cutblock. Once a cutblock is determined to be "mature" in a cruise compilation (based on 50 + % of coniferous timber having an average age of 121 years or older and deciduous timber having an average age of 41 years or older), the Mature Timber Merchantable Specifications shall be used for waste measurement of all coniferous and deciduous timber left within the cutblock.

Conversely where a cutblock belongs to immature in a cruise, the Immature Timber Merchantable Specifications shall be used for waste measurement of all coniferous and deciduous timber left within the cutblock.

Table 1-2 Interior Timber Merchantability Specifications

Description		All Stands	
Stumps**			
•	no higher than	30 cm	
Diameter (outside bark) at stump height			
•	Lodgepole pine: all timber that meets or exceeds	15 cm	
•	All other species: all timber that meets or exceeds	20 cm	
Top diameter (inside bark or slab thickness)			
•	For all species and ages, except Cedar older than 141 years, all timber that meets or exceeds	10 cm	
•	For Cedar older than 141 years	15 cm	
Minimum length			
•	log or slab	3 m	
**	Measured on the side of the stump adjacent to the highest ground.		

Waste volumes are measured and billed monetarily in accordance with the following Table 1-3.

Table 1-3 The Disposition of Residue and Waste Volumes in Monetary Billing

Table Effective April 1, 2019 (Valid for all Species)										
Log Type	GRADES		All Stands							
			Avoidable				Unavoidable			
	COAST	INTERIOR	Class	Measure / Record	Rate*	AAC	Class	Measure / Record	Rate*	AAC
			W/X	YES/NO	YES/NB		W/X	YES/NO	YES/NB	
Sawlog **	U or Better	1 and 2	W	Yes	Yes	Yes	W	Yes	NB	Yes
Saw log Hembal	J or Better									
Sawlog **	X	N/A	W	Yes	Yes	Yes	W	Yes	NB	Yes
Sawlog Hembal	U									
Lumber Reject	Y	4	W	Yes	Yes	Yes	W	Yes	NB	Yes
Dead Dry Lumber Reject	Dry Y	Dry 4	X	No	NB	No	X	No	NB	No
Undersize	N/A	6	X	No	NB	No	X	No	NB	No
Firmwood Reject	Z	Z	X	No	NB	No	X	No	NB	No

*Rate: Rates will be billed as per section 1.2.4 - Monetary Billings.

** On Coast, all species except Hemlock and Balsam.

AAC Volume contributing to Cut Control

N/A Not applicable

NB No billing

W Waste

X Other

See Appendix 5 for waste benchmarks.

1.2.2 Rationale

The right to harvest Crown timber is granted in the form of agreements under the *Forest Act*.

The licensee has the discretion of whether or not to harvest the timber from the agreement area subject to the forest management standards required.

Pursuant to the *Forest Act*, an agreement holder must pay stumpage for timber that was harvested.

Under the *Forest Act* and the agreements, the licensee must pay a waste assessment for merchantable timber not harvested and for timber deemed to be wasted.

1.2.3 Scale Based Cutting Authorities

Where the amount of stumpage payable on the timber harvested from a cutting authority is calculated using the information reported in a scale of the timber, the holder of the agreement must conduct a waste assessment on that cutting authority.

1.2.4 Cruise Based Cutting Authorities

Where the amount of stumpage payable on the timber harvested from a cutting authority is calculated using the information reported in a cruise of the timber, the holder of the agreement is not required to conduct a waste assessment on that cutting authority.

1.2.5 Definitions

“**Avoidable waste**” means waste that does not fall within the definition of unavoidable waste.

“**Conventional**” means any harvest method that does not use a helicopter;

“**Fibre Recovery Zone**” (**FRZ**) means the area that is within the geographic boundaries of a Fibre Recovery Zone established by the director of Forest Tenures Branch.

- i. Fibre Recovery Zones are subdivided into three units: Immature Crown Timber, Mature and Immature Crown Timber, and Mature Crown Timber.
- ii. The location(s) of Fibre Recovery Zone(s) may be found online at: <https://www2.gov.bc.ca/gov/content/industry/forestry/competitive-forest-industry/timber-pricing/forest-residue-waste>
- iii. The map is provided as a general spatial representation of the Fibre Recovery Zone boundaries.

- iv. To determine if an area of interest falls within a Fibre Recovery Zone, please refer to the [WHSE ADMIN BOUNDARIES.FADM FIBRE RECOVERY ZONES S P layer](#) located in the BC Geographic Warehouse.

"**Merchantable timber**" means timber that meets or exceeds the timber merchantability specifications that are described in Table 1-1 for the Coast and in Table 1-2 for the Interior in this manual. Timber that is graded dry Y (5) or Z (Coast), graded dry 4, 6 or Z (Interior) is not merchantable.

"**Timber Merchantability Specifications**" means stump height and diameter, log top diameter, slab thickness and log length described in this manual for the Coast and the Interior.

"**Unavoidable waste**" means waste that:

- i. is inaccessible or physically obstructed;
- ii. could not be felled, bucked or removed due to safety or environmental reasons.

"**Waste**" means timber, except timber reserved from cutting, whether standing or felled, which meets or exceeds the timber merchantability specifications described for the Coast and the Interior in this manual that was not removed from the cutting authority area.

"**Waste assessment**" means an assessment conducted in accordance with the procedures set out in the *Provincial Logging Residue and Waste Measurement Procedures Manual* for determining the volumes of merchantable timber and waste left on a harvested area following completion of primary logging.

"**Waste benchmark**" means the volume of avoidable waste, expressed in cubic metres per hectare, that can be left on a harvested area without being subject to a monetary waste assessment.

1.2.6 Monetary Billings

Subject to the waste benchmarks described in Appendix 5, the avoidable waste volumes are billed as follows.

1.2.6.1 Coast

The avoidable conifer grade X, Y and grade U hemlock and balsam waste volumes are billed at:

- i) \$0.25 per m³ when originating from timber located outside a Fibre Recovery Zone **or when the FRZ adjustment factor is 1**, or
- ii) \$2.00 per m³ when originating from timber located inside a Fibre Recovery Zone **and the FRZ adjustment factor is greater than 1**.

Dead/dry grade Y (grade 5) timber not removed from the harvested area is not measured in waste assessments.

The avoidable coniferous waste volumes for hemlock and balsam that are Grade J or better, and for all other species, grade U or better, are billed at rates determined in section 7.4.1 of this manual.

1.2.6.2 Interior

The avoidable waste volumes of grade 4, lumber reject; are billed at \$0.25 per m³.

The avoidable sawlog grades (1 and 2) volumes are billed at the rates determined in section 7.4.1 of this manual.

1.2.7 Deciduous

Deciduous species are treated the same as coniferous species for waste billing purposes. Deciduous timber within the merchantability specifications that is not harvested is measured as waste.

The avoidable sawlog volumes for deciduous species are billed at:

- i. the fixed rate for the species as specified in the *Coast and Interior Appraisal Manuals*, plus any bonus and levies where applicable when the source of the timber is located outside of a Fibre Recovery Zone, **or when the FRZ adjustment factor is 1, or**
- ii. \$2.00 per m³ when the source of the timber is located inside a Fibre Recovery Zone **and the FRZ adjustment factor is greater than 1.**

The avoidable volumes of grades other than sawlog are billed at:

- i. the rates established as per *Coast and Interior Appraisal Manuals* when the source of the timber is located outside a Fibre Recovery Zone, **or when the FRZ adjustment factor is 1, or**
- ii. \$2.00 per m³ when the source of the timber is located inside a Fibre Recovery Zone **and the FRZ adjustment factor is greater than 1.**

1.2.8 Amount Payable

For merchantable Crown timber that is not cut and removed, the amount payable is calculated by multiplying:

- a. the volumes of avoidable waste reported in a waste assessment after deducting the waste benchmark volume allowed under Appendix 5, by
- b. the applicable rates specified in 1.2.4.1, 1.2.4.2, and 1.2.5

1.3 Authority

Waste assessments are carried out under the authority of:

1. The *Forest Act*.
2. The Waste Assessment Policy.
3. The *Provincial Logging Residue and Waste Measurement Procedures Manual*.
4. Agreement and Cutting Permit documents.

1.4 Background

Starting in the late 1960s, timber harvesting policy provided for waste measurements. At that time, in the Interior, waste measurement provisions were by and large not exercised except where waste was considered flagrant. On the Coast, waste was measured and charged for cut control purposes but only waste considered 'flagrant' was billed on a monetary basis. The definition of flagrant waste varied over the years.

In the mid-1980s some major forest companies on the Coast left very high levels of waste. In response to public outcries on the Queen Charlottes Islands in 1987, the Ombudsman commissioned T.M. Thomson & Associates to review a major coastal licensee's waste measurement procedures and utilization practices on the Queens Charlottes. The review determined that there was a need to develop consistent and enforceable utilization standards and waste measurement procedures for the entire province.

The responsibility for developing the utilization policy was placed with the Director of RTEB. The Coast and Interior utilization policies were implemented in the early 1990s. Both policies prescribed the minimum cutting specifications, log grade utilization and cut control requirements.

The responsibility for developing the waste measurement standards was placed with the Director of Timber Pricing Branch. Necessitated by the implementation of the zero waste policy, the *Residue and Waste Measurement Procedures Manual* was released and approved for use in the entire province in 1991. All harvest completed cutblocks in the Interior and on the Coast were required to have waste measured and reported in accordance with the standards and procedures set out in the manual.

Until the year-end of 1998, the province had a zero waste policy. Under this policy, logs that were sawlog grade were required to be utilized (mandatory utilization); if they were not utilized and left on the cutblock, these logs were classified and billed as waste. This policy meant that all useable logs except low quality pulp (grade Y or 4) logs, were required to be removed from the cutblock by the company licensed to harvest the area.

Under this policy, all logs that were sawlog grade and physically possible to be removed were required to be utilized by the licensees.

Starting in 1999, waste benchmarks were established to allow a volume of waste to be left without being monetarily billed. The waste benchmarks allow the licensees to decide which logs to remove or to leave behind as waste. The concept was that market forces would drive the business decisions. Licensees would recover logs to their economic margins. Another purpose of the waste benchmarks was to accommodate coarse woody debris, which is important in the nutrient and organic matter dynamics of forest ecosystems.

The benchmarks were not based on scientific studies or quantitative analyses. Rather, the benchmarks were set as a starting point to recognize that zero waste was not a sound ecological policy and economics was not served by compelling licensees to remove every log.

In the spring of 2003, the government announced the Forestry Revitalization Plan and brought forward legislation to reform forest policy. Waste policy was further aligned with the Ministry policy reform undertaken to allow market forces to drive business decisions. Foremost was the elimination of the mandatory species and log grade utilization (cut and remove) requirements, so that licensees are free to extract any logs of value to them within the cutting authority areas subject to the *Forest and Range Practices Act* and the required forest management standards. Licensees must pay stumpage on timber removed and scaled, and waste assessments on timber, whether standing or felled that was not removed from the cutting authority area. This is referred to as the “Take or Pay” Policy.

In 2015, in response to a need for more complete and efficient utilization of wood fibre the government, in cooperation with the Forestry Fibre Working Group announced the *Forest Fibre Action Plan*.

1.5 Responsibility

The responsibilities are as follows:

1.5.1 Timber Pricing Branch

1.5.1.1 Director, Timber Pricing Branch

The Director, Timber Pricing Branch is responsible for:

1. Approving *Provincial Logging Residue and Waste Measurement Procedures Manual* and amendments.
2. Processing and maintaining waste data.
3. Billing licensees by issuing waste invoices for monetary and cut control charges.

1.5.1.2 Residue and Log Salvage Policy Forester, Timber Pricing Branch

The Residue and Log Salvage Policy Forester is responsible for:

1. Developing and maintaining standards and procedures for determining and reporting waste.
2. Providing training and technical support.
3. Providing policy interpretation to industry and ministry staff.
4. Maintaining software compilation programs and standards.
5. Conducting technical reviews of Forest Regions and Forest Districts for policy and procedure compliance.

1.5.2 Regional Manager

The Regional Manager is responsible for:

1. Ensuring that district staff adhere to policy and procedures, and where necessary, provide training to district staff.
2. Recommending survey procedure changes where necessary, to the Director, Timber Pricing Branch.
3. Advising industry and forest district staff on matters relating to waste assessments.
4. Processing waste reports and FS 702 for waste monetary billing and cut control where required.
5. Providing Waste System guidance and training to district staff and industry users.

1.5.3 District Manager

The District Manager is responsible for:

1. Conducting check surveys in accordance with manual standards.
2. Implementing and administering the policy and procedures, and recommending survey procedure changes where necessary to the Regional Manager.
3. Approving waste assessment plans and issuing reporting unit numbers.
4. Checking for completeness of licensees' submitted reports.
5. Processing waste reports and FS 702 for waste monetary billing and cut control where required.

1.5.4 Timber Sales Manager

Unless otherwise specified in the agreement, the Timber Sales Manager is responsible for:

1. Ensuring BCTS Licensees submit waste assessments in accordance with licence agreements, Waste Policy and the *Provincial Logging Waste Measurement Procedures Manual*.
2. Where a BCTS licensee does not submit a waste assessment as required under 1.5.4(1) the timber sales manager may carry out the assessment, and in a notice given to the holder, may require the holder to pay the costs incurred by the timber sales manager in carrying out the assessment.

1.5.5 Licensees

Agreement holders are responsible for conducting waste assessments on their scale based cutting authorities **in accordance with the *Forest Act***.

The licensees are responsible for:

1. Submitting annual waste assessment plans.
2. Conducting waste assessments in accordance with this manual.
3. Submitting waste field data into the online Waste System.

Where the above mentioned work is performed by a contractor or a sub-contractor, it is the licensee's responsibility for ensuring that the work is carried out in compliance with Ministry standards and requirements.

1.6 Waste Relief Applications

A licensee may apply, in writing, for waste relief with respect to the timber left on a cutting authority provided the government has not issued a waste assessment (invoice) for the timber to the licensee.

1.6.1 Initiating an Application for Waste Relief

An application for waste relief must include:

1. a written statement from the licensee that:
 - a. identifies the applicable Part of the Waste Relief Policy under which the application is made; and
 - b. explains the basis on which the licensee considers that the circumstances relating to the cutting authority meet the criteria of that Part;
2. any evidence upon which the licensee relies; and
3. data on the timber volumes and grades in relation to which the licensee is seeking the relief (the “supporting data”)
(collectively, the “application”).

The supporting data under paragraph 3 must:

- a. provide an accurate estimate of the timber volume remaining on each cutblock in the cutting authority. The estimate of remaining timber volume may be determined by methods that include, but are not necessarily limited to, one or more of the following:
 - i. a full waste survey conducted in accordance with this manual;
 - ii. a timber cruise with a map showing the locations of the timber included in the application.
- b. be submitted into the Waste System with a notation or comment in the Waste System identifying that the information pertains to an application for waste relief.

The licensee must submit the written statement and evidence to the Area Director of Pricing and Tenures and the supporting data into the Waste System.

1.6.2 Processing of Application

Following receipt of an application that complies with the requirements of section 1.6.1, the Area Director of Pricing and Tenures will direct the preparation of a draft information package that includes:

1. the licensee’s application,
2. relevant additional information on the cutting authority,
3. an estimated waste monetary assessment based on the timber grade profile (for each cutblock in the application as applicable) and the applicable waste rates,
4. if the application is made under Part 2 of the Waste Relief Policy, an assessment of the opportunity for resale of the timber included in the application, including the current market value, and

5. a draft Briefing Note to the ADM providing analysis of whether the application meets the criteria of the Waste Relief Policy and should be approved.

The Area Director of Pricing and Tenures will forward the draft information package in electronic form to the Director, Timber Pricing Branch, Ministry of Forests, Lands, Natural Resource Operations and Rural Development.

The Director, Timber Pricing Branch will review, update, and submit the information package to the ADM for a preliminary assessment.

If the ADM's preliminary assessment following review of the information package is that the application:

1. should not be approved:
 - a. the ADM will disclose to the licensee the evidence and rationale supporting the preliminary assessment and offer the licensee the opportunity to respond within a defined period;
 - b. any response from the licensee must be submitted to the ADM and is appended into the information package;
 - c. if the ADM determines that further clarification is needed, the ADM will offer the licensee the opportunity to provide such clarification within a defined period, and any response from the licensee must likewise be submitted to the ADM and appended into the information package;
 - d. once the ADM is satisfied that no further clarification is required regarding the licensee's response the information package is deemed to be final; and
 - e. the final waste relief determination is made under section 1.6.3.
2. should be approved:
 - a. the information package is deemed to be final, and the final waste relief determination is made under section 1.6.3.

1.6.3 Final Waste Relief Determination

Following review of the final information package, the ADM will approve or reject the application and notify the licensee, with a copy to the District Manager, the Timber Sales Manager in the case of BCTS agreements, and the Area Director of Pricing and Tenures.

If the application is rejected, the waste survey will be processed, and an invoice will be issued for the timber included in the application.

If the application is approved, the waste survey submission status in the Waste System will be updated so that billing will not occur for the timber included in the application.

This page has been left intentionally blank

2 General Assessment Requirements and Reporting Units

2.1 Field Assessments and Reporting Time Frames

1. Where the amount of stumpage payable on the timber harvested on a cutblock by the holder of:

- a. a major licence,
- b. a community forest agreement,
- c. a community salvage licence,
- d. a woodlot licence,
- e. a road permit,
- f. a licence to cut, or
- g. a timber sale licence,

is calculated using the information reported in a scale of the timber, the holder of the agreement must conduct a waste assessment on that **waste assessment area the earliest of:**

- i. sixty (60) days after primary logging has been completed on the **waste assessment area**, or
 - ii. within sixty (60) days after the cutting authority authorizing the harvesting of that timber expires or is otherwise terminated, whichever occurs first, or
 - iii. as soon thereafter that the ground is sufficiently free of snow that an assessment may be carried out on the cutblock.
2. The holder must submit the waste assessment data for a cutblock to the district manager within thirty (30) days of the completion of the waste assessment.

2.2 Continuing Liability

In accordance with section 79 of the *Forest Act*, and notwithstanding the time frames specified in Section 2.1 for conducting and submitting a waste assessment, and despite the expiry, surrender, suspension or cancellation of a holder's agreement, the holder of an agreement is required to conduct a waste assessment, and pay the fees, costs and invoice billings owing to the government in respect of the waste assessment.

2.3 Overdue Waste Assessments and Reports

1. Where the holder of an agreement, other than an agreement entered into with the timber sales manager, does not complete the waste assessment and submit it to the district manager as required under Section 2.1, the district manager may in a notice given to the licensees, take actions to ensure assessment of waste for a block or blocks.
2. Where the holder of an agreement entered into with the timber sales manager that is required by that agreement to conduct a waste assessment, fails to conduct that waste assessment, the timber sales manager may carry out the assessment, and in a notice given to the holder, may require the holder to pay the costs incurred by the timber sales manager in carrying out the assessment.

2.4 Reporting Unit Options

1. Blocks are reported in the Waste System using a 'Reporting Unit' that is unique to the license owner of the block(s). A Reporting Unit is a reporting mechanism to store and report waste information. Reporting Units can be created for the following reporting options:
 - a. the cutblock option – used to report a waste assessment area.
 - b. the aggregate option – used to report a group of blocks using the parent/child method.
 - c. the ocular estimate option – used to report a group of blocks using only ocular estimate submissions.

2.4.1 Waste Assessment Area

A waste assessment area can be either a cutblock, or a portion of a cutblock submitted in a waste assessment.

Cutblocks containing both helicopter and conventional harvest methods must be separated into two waste assessment areas and sampled separately in the Coast Area.

Waste assessments may be submitted as separate waste assessment areas for each year of harvest when the harvest of a cutblock has occurred over multiple years.

2.4.2 Fibre Recovery Zone Cutblocks

Waste assessments for cutblocks in which a portion of the cutblock area is within a Fibre Recovery Zone, and the FRZ waste rate is applicable to the waste assessment area, must be surveyed either:

1. As two waste assessment areas, with one assessment area within a Fibre Recovery Zone and the other assessment area outside of a Fibre Recovery Zone, or
2. As one waste assessment area, and
 - a. The waste assessment area submitted into the Waste System will contain the areas inside and outside the FRZ, and
 - b. The FRZ rate will apply to the entire submission.

2.4.3 Cutblock Option

1. Where the holder of an agreement uses the cutblock option, each cutblock is a separate reporting unit.
2. Each cutblock must be sampled in accordance with the number of plots required to meet the approved sampling error objective that applies to that cutblock as required in Chapter 4 of this manual.

2.4.4 Aggregate Option

The aggregate option is a method of reporting waste for more than one waste assessment area.

1. Where the holder of an agreement uses the aggregate option, waste assessment areas may be amalgamated to form an Aggregate Reporting Unit. An aggregate reporting unit must be comprised of at least two cutblocks which can be originated from different cutting authorities.
2. Subject to subsection (3) of this section, an aggregate reporting unit may only be comprised of waste assessment areas from within a single Forest District that have been harvested by the holder of an agreement.
3. Each aggregate reporting unit may only consist of:
 - a. only waste assessment areas that contained old growth timber,
 - b. only waste assessment areas that contained second growth timber, or
 - c. only waste assessment areas that contained timber that was transported from the waste assessment area by a helicopter.
4. Each waste assessment area within the aggregate reporting unit must be assessed individually using either the number of plots as calculated using the pertinent algorithm in Table 4-1 of this manual or the Historic Waste Information from Appendix 7 of this manual.
5. Aggregate reporting units created for all methods must be sampled in accordance with number of plots required to meet the sampling error objective that applies to that reporting unit as required in Chapter 4 of this manual.
6. Where the holder of an agreement uses the aggregate option and did not meet the sampling error objective when using an aggregate option previously, the holder must use the next higher coefficient of variation required to be used by this manual unless the district manager determines that the use of the lower coefficient of variation will not create a significant revenue risk to the government.

2.4.5 Ocular Estimate Option

1. Where the holder of an agreement uses the ocular estimate option, each reporting unit may be comprised of one or more waste assessment areas.
2. Where the waste benchmark will be exceeded using the ocular estimate option, the holder of the agreement must use another option authorized by this manual unless the district manager determines that the revenue risk to the government caused by the use of the ocular estimate option is minimal.
3. Where the ocular estimate option is used, there is no requirement to meet the sampling error objective required under Chapter 4 of this manual.

This page has been left intentionally blank

3 Alternative Methods

Waste assessments may be conducted using:

- a. the Full Sampling Intensity survey method (FSI method),
- b. the Reduced Sampling Intensity survey method (RSI method),
- c. the Parent Block survey method (PBmethod),
- d. the Ocular Estimate surveymethod (OE method),

as and when permitted by the provisions of this manual.

3.1 The RSI Method

1. The RSI Method may only be used in a dispersed stratum on a waste assessment area if:
 - a. the cutblock option is used on that waste assessment area, and
 - b. subject to subsection 2 of this section, the estimated volume per hectare of avoidable waste in the dispersed stratum is less than the maximum dispersed volume prescribed in the Table 3-1 of this manual.

Table 3-1 RSI Thresholds

Location of Cutblock	Stand Description	Maximum Dispersed Volume
In the Coast Forest Area	Second Growth	20 m ³ /ha
	Old Growth	35 m ³ /ha
In the Southern Interior Area or Northern Interior Area	Dry Belt *	8 m ³ /ha
	Transition *	20 m ³ /ha
	Wet Belt *	35 m ³ /ha

2. The District Manager may permit the use of the RSI survey method in a dispersed stratum where the estimated volume per hectare measurement of avoidable waste in the dispersed stratum exceeds the maximum dispersed volume prescribed in Table 3-1 of this manual if the district manager determines that there is not a significant revenue risk to the government.

3.1.1 RSI Method Procedures

1. The number of dispersed plots on the waste assessment area:
 - a. must be in accordance with Table 4-2 of this manual where the cutblock is in the Coast Forest Region, and,
 - b. must be in accordance with Table 4-4 of this manual where the cutblock is in one of the Interior Forest Regions.
2. The coefficient of variation (C.V.) that must be used is 100 percent.
3. The number of dispersed plots that must be used is one quarter of the number of plots that are required by:
 - a. Table 4-2 of this manual where the waste assessment area is in the Coast Forest Region, or

- b. Table 4-4 of this manual where the cutblock is in one of the Interior Forest Regions.
4. The plot must be:
 - a. circular, rectangular, a line transect, and
 - b. at least 400 m² in size.
5.
 - a. Where the waste assessment area is a partial cutting cutblock specified under Section 4.7 of this manual, a plot size smaller than 400 square meters may be used.
 - b. Where a smaller plot size is used under this subsection the number of plots that must be used must be calculated in accordance with the new C.V. formula that is set out in:
 - i. Table 4-2 of this manual where the cutblock is in the Coast Forest Region, or
 - ii. Table 4-4 of this manual where the cutblock is in one of the Interior Forest Regions.
6. There is no requirement to meet the sampling error objectives in Tables 4-2 and 4-4 of this manual
7. The field measurements that must be made and the recording requirements that must be met when using the RSI method are the same as those that must be made and met when using the FSI method.

* These site types are defined in the BEC zones link in the waste system homepage at:

<http://www2.gov.bc.ca/gov/content/industry/forestry/competitive-forest-industry/timber-pricing/forest-residue-waste>

3.2 Parent Block (PB) Method

The PB method includes the use of waste survey data from a surveyed waste assessment area hereinafter referred to as the “parent block” for applying the volume per hectare data to an unsurveyed cutblock hereinafter referred to as the “exempted block” which meets the conditions in Section 3.2.1.

3.2.1 Parent Block Method - Conditions

The holder of an agreement may only use the PB method where:

- a. the area of the exempted block is 20 ha or less, unless the district manager determines that the use of the PB method on a larger waste assessment area will not create a significant revenue risk to the government,
- b. the parent block was surveyed using plots,
- c. the parent block waste survey is in the Waste System records, and on the Coast, the parent block was surveyed using Appendix 6, Coast grading procedures,
- d. the district manager determines that:
 - i. the anticipated amount of waste in the exempted block is similar to the amount of waste in the parent block, and
 - ii. the species composition in each of the two blocks was similar.

3.3 Ocular Estimate (OE) Method

1. Where the estimated volume per hectare of avoidable waste on the waste assessment area is below the maximum volume prescribed in Table 3-2 of this manual, the use of the OE method does not require approval of the district manager.
2. The use of the OE method will not be permitted on a waste assessment area if the estimated volume per hectare of avoidable waste on the waste assessment area exceeds the maximum waste volume prescribed in Table 3-2 of this manual, unless the district manager determines that the use of this method will not create a significant revenue risk to the government.

Table 3-2 Ocular Estimate Thresholds

Location of Cutblock	Stand Description	Maximum Avoidable Waste Volume (sawlogs)
In the Coast Forest Area	Second Growth	10 m ³ /ha
	Old Growth	35 m ³ /ha
In the Northern Interior Area or the Southern Interior Area	Dry Belt	4 m ³ /ha
	Transition	10 m ³ /ha
	Wet Belt	20 m ³ /ha

3. Subject to subsection (4) of this section, the holder of an agreement may not use the OE method unless a licensed waste surveyor, licensed scaler, RPF or RFT certifies the accuracy of and submits the results of the assessment on behalf of the holder of an agreement to the district manager.
4. The district manager may permit the holder of the agreement to use the OE method and to submit the results of waste assessment directly to the district manager without the certification required by subsection (3) of this section where the agreement held by the holder is a woodlot licence, if the district manager determines that there is not significant revenue risk to the government by receiving the results of the waste assessment directly from the holder of the agreement.
5. Transect line or inspection plots:
 - a. should be used when using the OE method and
 - b. should be located in areas of the waste assessment area where the levels of avoidable waste reasonably represent the avoidable waste on the waste assessment area.

6. Where inspection plots are used, each plot should be:
 - a. Circular or rectangular, and
 - b. At least 50 m² in size.
7. Where a field audit conducted on behalf of the district manager determines that the waste assessment conducted by the holder of an agreement on the waste assessment area using the OE method does not reasonably represent the avoidable waste on the waste assessment area, the district manager may reject the waste assessment.

3.3.1 Ocular Estimate Method – Best Field Practices

For the purpose of maintaining uniform standards, the following procedures are available for use in deriving the ocular estimates.

The surveyor is responsible for ensuring that the ocular estimates derived are defensible and valid for the waste assessment area.

The supporting ocular field data need not be submitted but must be made available when requested by the Ministry of Forests, Lands, Natural Resource Operations and Rural Development staff.

1. Dispersed Stratum
 - a. Plots:
 - Put in inspection plots, circular or rectangular (at least 50 m² in size) in areas that reasonably cover the different waste types on the waste assessment area, or
 - b. Transect:
 - Put in transect lines that provide good sample coverage of the stratum being surveyed,
 - Start from the road or a good tie point (marked and ribboned), traverse at an angle to the boundary and then traverse back to the road on a different pathway,
 - The width of the transect line should provide good access for clean readily accessible measurement (usually 2 to 5 metres). Measure all the pieces within the transect area.

2. Accumulated Stratum

a. Wrap Around:

- Measure all waste pieces that can be reached on the outside of the entire pile or

b. Sectional Wrap:

- For very large piles, divide the pile into equal halves, mark the dividing points for the halves. Perform a wrap around one-half and if the half is unreasonably large, cut in half again and perform the wrap around on an equal quarter, or

c. Swath Method:

- This is the same as the dispersed transect method. The swath must be wide enough to give a reasonable sample (10 m) or use multiple smaller (5 m) swaths. This is usually appropriate for windrows, or

d. Plot on Top of Pile:

- Where there is no safety concern, use the procedures described in section 5.1.7.

Respecting each of above, apply a measure factor (MF) to the portion of the pieces or sampled areas that were measured. Strive to measure as many pieces as possible; the estimates will be more accurate with a higher MF.

3.4 The OE Method and Standing Timber

1. Where a waste assessment is conducted on standing timber using the OE method, the average net piece volume for each 5 cm DBH class for each species contained in the Extended Type Stand and Stock Tables or the net merchantable volume per tree in the Timber Type Summary, in the cruise compilation may be used to derive the standing timber volume.
2. Subject to subsection (3) of this section, the species and grades for the standing timber on a cutting authority area must be derived from the HBS billing history records held by the Timber Pricing Branch of the Ministry of Forests, Lands, Natural Resource Operations and Rural Development for the timber that has been harvested on the cutting authority area during the 12-month period prior to the date that primary logging was completed on the cutting authority area.
3. The species and grades for the standing timber may be established by an RPF or RFT by conducting a visual on site examination of the standing timber if:
 - a. there are no billing history records, or,
 - b. the RPF, RFT or the Ministry employee who is responsible for reviewing waste assessments determines that the billing history records do not reasonably represent the species and grade profile of the standing timber on the cutting authority area.

Waste Volumes

Forest District:		Licensee:				
Timbermark:		RU:	Return Number:			
Licence:	CP:	Block:				
Block Net Area: ① + ② + ③ ha						
Date Primary Logging Completed:	Avoidable Waste Benchmark: m ³ /ha	Block Leading Species:				
Ocular Estimates						
	DISPERSED		ACCUMULATED		STANDING TREES	TOTAL
Stratum Code *						
Area (ha)	①		②		③	
Avoidable	m /ha	Total (m ³)	m /ha	Total (m ³)	Total (m ³)	Total (m ³)
Sawlog waste (1)						
Sawlog waste (2)						
Grade 4 (Y)						
Total Avoidable						
Unavoidable						
Sawlog waste						
Grade 4 (Y)						
Total Unavoidable						
Grand Total						
<p><i>* Refer to Section 5.7.2 of the Provincial Logging Residue and Waste Measurement Procedures Manual.</i></p> <p>I hereby provide the above estimates in lieu of a waste survey. I agree to the use of these figures for cut control and waste monetary billing purposes.</p>						
Additional Comments:						
Surveyor/Scaler Name and No:			RPF/RFT Name and No:			
Signature (Licensee or Representative):			Forest Officer			
Date:						

2010/03

Please be advised that this information may be released under the *Freedom of Information and Protection of Privacy Act*.

Figure 3-1 RW01 Estimate Form - Interior

Waste Volumes

Forest District:		Licensee:				
Timbermark:		RU:	Return Number:			
Licence:	CP:	Block:				
Block Net Area: ① + ② + ③		ha		Stand (check box)	<input type="checkbox"/> Immature <input type="checkbox"/> Mature	
Date Primary Logging Completed:	Avoidable Waste Benchmark:		Block Leading Species:			
	m ³ /ha					
Ocular Estimates						
	DISPERSED		ACCUMULATED		STANDING TREES	TOTAL
Stratum Code *						
Area (ha)	①		②		③	
Avoidable	m ³ /ha or #	Total (m ³)	m ³ /ha or #	Total (m ³)	Total (m ³)	Total (m ³)
Conifer U grade or better						
HemBal U grade						
Conifer X grade						
Conifer Y grade						
Decid sawlog						
Decid Y grade						
Unavoidable						
Piles						
Decked wood						
* Refer to Section 5.7.2 of the Provincial Logging Residue and Waste Measurement Procedures Manual. Conifer U grade or better excludes HemBal U grade. Piles = Avg. Vol/Pile * number of Piles. Enter number of decks and volume of decked wood under Accumulated.						
I hereby provide the above estimates in lieu of a waste survey. I agree to the use of these figures for cut control and waste monetary billing purposes.						
Additional Comments:						
Surveyor/Scaler Name and No:			RPF/RFT Name and No:			
Signature (Licensee or Representative):			Forest Officer			
Date:						

2010/03 COAST

Please be advised that this information may be released under the *Freedom of Information and Protection of Privacy Act*.

Figure 3-2 RW01 Estimate Form – Coast

4 Block Planning and Plot Layout

4.1 The Plot Sampling Process

The planning and implementation of plot sampling surveys involves either one waste assessment area or an aggregation of waste assessment areas. For either cutblock or aggregate sampling, follow these steps:

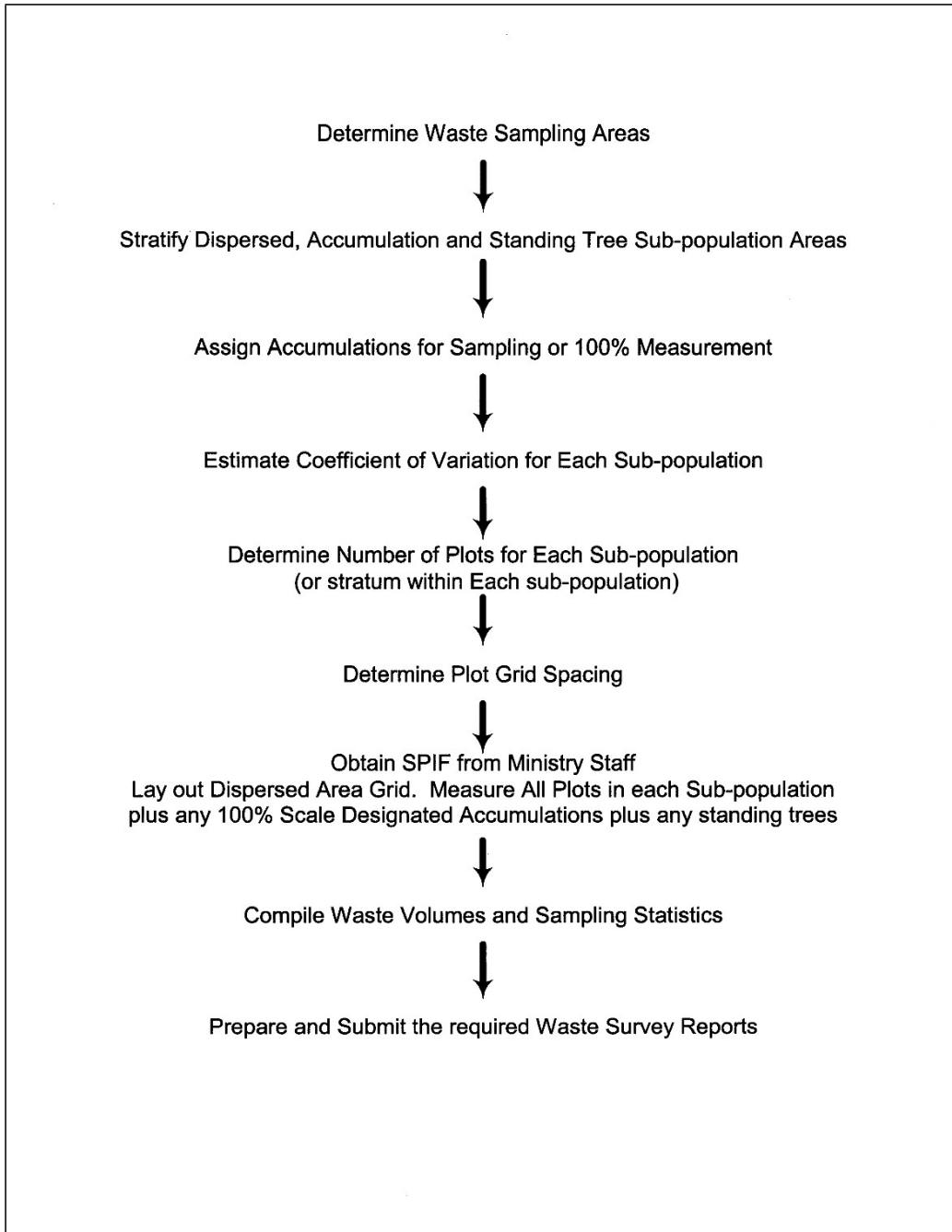

Figure 4-1 Plot Sampling Process

4.2 Sampling Design

4.2.1 Population

The population is the volume of waste generated during the specified reporting year within the approved waste reporting unit. The size of the population depends on:

- a. the option selected for the waste reporting unit,
- b. the area logged in that year.

4.2.2 Sub-Populations

The population usually consists of three sub-populations: accumulated, dispersed and standing trees. Each sub-population may be subdivided into one or more strata.

Accumulated waste occurs at landings, along roadsides and at other areas in the reporting unit where logs have been yarded or skidded to and where sample plots may be established. Where sample plots cannot be safely established, or are not appropriate, volumes are either estimated or 100 percent measured (each piece measured individually).

Dispersed waste occurs on the areas from which trees or logs have been removed and where sample plots can safely be established. Dispersed areas are sampled independently of accumulation areas. The area of the rights-of-way leading into the waste assessment area must be included in the net area of waste assessment area unless the waste volume has been included in a previous waste survey or as provided under Section 4.6.2.

Standing trees are trees authorized for harvest under the cutting authority (excepting reserved trees) but at the discretion of the licence holder, are not cut and removed.

Individual standing trees that are found at different locations of the waste assessment area can be measured and scaled individually and be treated as part of the dispersed sub-population. Standing tree patches will be delineated separately from the dispersed to form their own sub-population and the volumes determined with methods outlined under Section 5.3.2.

4.2.3 Stratification

Stratification can increase the precision of sub-population volume estimates and reduce the amount of sampling required to achieve a desired level of precision.

It is therefore useful to stratify the sub-populations, where possible, by harvesting system, different logging contractor, timber type, or relative quantity of waste generated.

4.2.4 Block Survey Plan

A good block survey plan in the form of a map is essential to an efficient waste survey.

The Block Survey Plan is not required to be approved by the District Manager.

A licensee or party responsible for survey must submit a Block Survey Plan or Notification to the District Manager thirty (30) days prior to the anticipated field work providing information required by the District Manager.

Only one survey plan or notification may be submitted for each waste assessment area, and waste report submissions must comply with the submitted plan or notification. No alterations will be allowed to be made to the waste billing volumes.

After the field survey is completed for the block, the final Block Survey Plan map must be submitted with the waste survey reports.

The map must show the waste assessment area boundaries, roads, the point of commencement, strip and plot locations, and must meet ministry standards. Each area must be carefully measured by mapping and planimetry. All roads, water, swamp and other non-forest areas must be delineated on the maps and the areas measured with a planimeter.

Accumulations and standing trees not harvested should be clearly indicated on the maps.

4.2.5 Sampling Objective

The sampling objective is to estimate the total volume of waste in each sub-population to a calculated minimum level of precision, or sampling error percent (S.E. %), at the 95 percent confidence level. Generally, calculated sampling errors decrease with increased sub-population size.

The sampling error and number of plots required for each sub-population are determined from plot Tables 4-2 to 4-5 in this chapter.

4.3 Sampling Method

There are four assessment methods as outlined in 5.7.2, they are PLOT (P), 100% Measure (S), Ocular Estimate (O), and Estimate Percent (E). Anyone or any combinations of the four assessment methods may be used in a waste assessment.

In both aggregate and cutblock options, the waste volume in the dispersed and accumulation subpopulations is calculated based on fixed-area sample plots laid out systematically. For the estimated or 100 percent piece scale subpopulations, waste volumes are either estimated or 100 percent measure for each specified stratum.

The fixed-area plots are established in a systematic, staggered grid pattern in dispersed types. In roadside accumulations the plot spacing depends on the average width of the accumulation. The grid spacing will also depend on the plot size and number of plots determined for the sub-population.

For accumulations, the licensees have the option of estimating volumes. Plots which fall on hazardous piles should be relocated; however, if unsuccessful, estimates will be allowed. Areas subject to 100 percent measurement or estimation should be typed out on the maps.

This manual prescribes either a cutblock or aggregate option using a combination of either fixed-area plots, estimations and/or 100 percent measure. Any variation from this sampling method requires written approval of the Director, Timber Pricing Branch.

The safety of the surveyor must always take precedence when estimating or measuring plots, including the wearing of proper safety equipment and footwear.

4.3.1 Number of Plots (Sample Size)

The number of plots and maximum sampling error for each sub-population are determined from plot tables. There are two sets of tables each for the Coast and Interior (dispersed and accumulation areas). These tables embody certain underlying assumptions concerning the volume, relative proportions of waste, cruise volume, and are specific to a given plot size.

To use the plot tables, you need the sub-population area and the estimated coefficient of variation (C.V.). This C.V. is specific to the individual plot volumes in that sub-population area.

If no coefficients of variation are available, use a "start up" C.V. estimate of 100 percent for the dispersed and accumulation sub-populations.

Subsequent estimates can be based on actual survey statistics. For the aggregate option, sampling proceeds as each cutblock is logged or becomes available.

4.3.2 Procedure to Determine the Number of Plots

Determine the minimum number of plots required for each sub-population as follows:

1. Determine the sub-population area (sum of stratum areas in the dispersed *or* accumulation sub-population).
2. Estimate the sub-population coefficient of variation, or use start up values.
3. From the appropriate dispersed or accumulation plot table, read the minimum number of plots required from the body of the table.
4. Read the maximum sampling error from the right-hand column of the table.
5. The minimum number of plots per stratum is 2, based on the sub-population area.
6. For the aggregate option, the number of plots for an *individual block* will be the result of the hectare to plot ratio *for all blocks in the aggregate* divided into the area of the block and rounded up to the nearest whole number, but the minimum of 2 plots per stratum still applies on *each* block.

For example:

If on the aggregate option you have a hectare to plot ratio of 6.2:1 and the area on one of the blocks is 41.5 ha, divide 41.5 by 6.2 to get 6.7; round up to 7 plots. If the number of plots before rounding is less than two, then at least two plots per stratum must be established on that block.

4.3.3 Grid Spacing

Follow Section 4.3.2 to determine the number of plots required.

For the cutblock option, the number of plots required for each block is taken directly from the appropriate plot table.

For the Aggregate option, the number of plots required for each block is calculated by dividing the gross area of the block by the hectare to plot ratio for the Aggregate, rounding to the nearest whole number.

For both the Cutblock and Aggregate options, the minimum number of plots per waste assessment area is 2, and the grid spacing is determined for each block.

Refer to the Grid Spacing Worksheet (Table 4-1). The grid spacing is calculated from the formula of $SQR(10\ 000 \times \text{ha/plots})$ where SQR means "take the square root of", and should be rounded down to the next 5 m.

If necessary, grid spacing is reduced or increased, in 10 m increments, to fit the required number of plots within the waste assessment area boundaries.

4.4 Plot Layout

4.4.1 Dispersed

Plots for dispersed types are to be located on a systematic, staggered grid. The steps required are as follows:

1. Using the hectares and an estimate of C.V. specific to the reporting unit, look up the minimum number of plots required in either Table 4-2 (Coast) or Table 4-4 (Interior).
2. Compute the grid spacing distance (GSD) using the grid spacing worksheet (Table 4-1).
3. Locate the POC where the main road enters the waste assessment area, and establish the baseline in the cardinal direction which most closely parallels the contours. The POC for helicopter blocks is the most south-westerly point on the block.
4. Obtain the Starting Point Interval Factor (SPIF) from the forest district staff. The SPIF (must be in effect for the month in which primary logging for the waste assessment area is completed), multiplied by the GSD will determine the horizontal distance from the POC to the mapped location of the initial strip (IS). (SPIF will be randomly determined by Ministry of Forests, Lands, Natural Resource Operations and Rural Development staff to either be 1/4, 1/2, 3/4 or other fractions of GSD.).
5. Map the initial strip (IS) at the SPIF distance along and at right angles to the baseline from the POC.
6. Map all remaining strips at the full GSD along the baseline in both directions from the IS. Strips are mapped at right angles to the baseline.
7. Number the Strips:
 - a. on blocks with North/South baselines number the strips sequentially from South to North, and
 - b. on blocks with East/West baselines number the strips sequentially from West to East.
8. On odd numbered strips, locate the first two plots at one half the GSD along the strip in both directions from the baseline. Locate the remaining plots at full GSD along the strip.
9. On even numbered strips, locate one plot at the intersection of the strip and the baseline, and all remaining plots at full GSD along the strip.
10. Number the plots. Each plot in a given block should have a unique number.

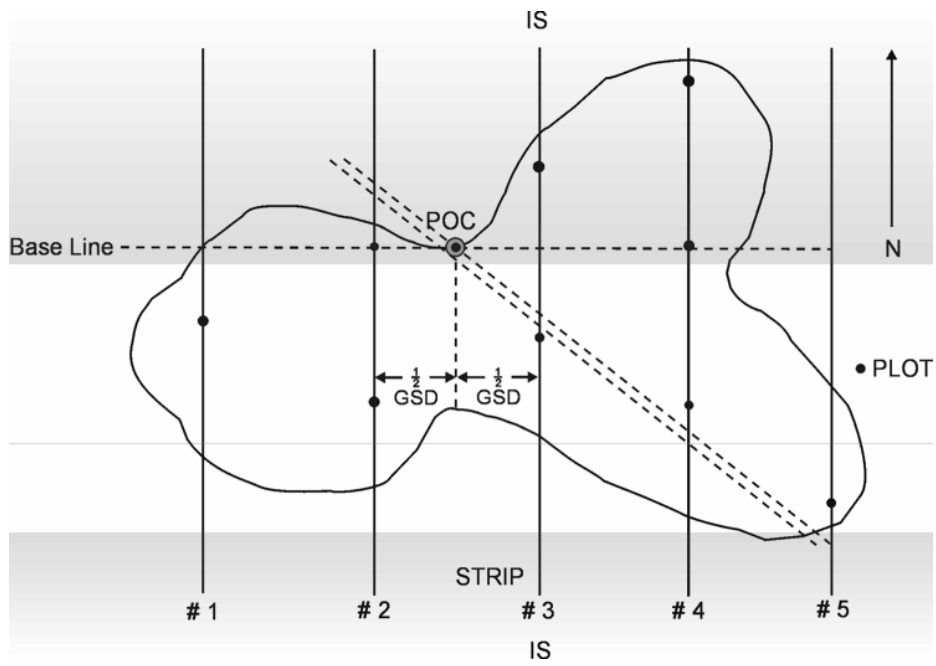

Figure 4-2 Strip and Plot Placement

4.4.2 Roadside Accumulations

For grapple yarding roadside accumulations, the number of plots required is based on the total area of the roadside accumulations. This area is calculated by measuring the length, along the road of "one-sided" and/or for "two-sided" accumulations. The length is then multiplied by an average width for the accumulation (usually but not restricted to 10 m).

The procedures are as follows:

One-sided or a mixture of one and two-sided accumulations	Two-sided Accumulations
<ol style="list-style-type: none"> 1. Start from the POC. 2. Measure the length of the one-sided accumulation; and the length of the two-sided accumulations multiplied by two. 3. Add the one-sided and two-sided accumulations together. 4. Calculate the area of the stratum as follows: $\text{Area (ha)} = (\text{length} \times \text{width}) / 10,000.$ 5. Look up the number of plots required from Table 3 (Coast) or Table 5 (Interior). 6. Calculate the grid spacing distance (GSD) as follows: $\text{Grid Spacing} = \text{length} / \text{number of plots required}.$ 	<ol style="list-style-type: none"> 1. Start from the POC. 2. Measure the length of the accumulations x 2. 3. Add the widths of the accumulations on both sides of the road together.
<p>Example:</p> <p>Total length of one-sided accumulation = 1500 m Total length of two-sided accumulation = 750 m x 2 = 1500 m 1500 m + 1500 m = 3000 m Area = 3000 m x 10 m = 3 ha = 15 plots (at 100% CV on the Coast) Grid Spacing Distance = 3000 / 15 = 200 m</p>	<p>Example:</p> <p>Total length of roadside accumulation = 3000 m x 2 = 6000 Width of roadside accumulation = 20 m (10 m on each side of the road) Area = 6000 m x 10 m = 6 ha = 16 plots (at 100% CV on the Coast) Grid Spacing Distance = 6000 / 16 = 375 m</p>

Laying Out of the Plots

1. Start from the POC and on the right hand side of the road.
2. Using the Starting Point Interval Factor (SPIF) for the month, establish the first plot at the GSD multiplied by the SPIF along the road.
3. For one-sided or a mixture of one and two-sided accumulations, locate a full size plot on the right side of the road. For two-sided accumulations, locate a full size plot on each side of the road.
4. Break chain the end of each accumulation and resume chaining at the beginning of the next accumulation until each GSD is covered.

5. Always stay to the right hand side of the road in the direction of travel when laying out the plots. When coming to a spur, go up the spur on the right hand side. At the end of the spur, turn around and come down on the right hand side.
6. For two sided accumulations when an odd number of plots are required, establish the last plot on one side of the road. If the last digit of the cutting permit is odd, establish it on the right hand side. If the last digit of the cutting permit is even, establish it on the left hand side.

Roadside accumulations must be marked on the map so the layout can be audited. When on-site stratification is done, it must be done on a non-bias basis.

4.4.3 Spot Accumulations

Spot accumulations include high-lead, spar, or tower landings, as well as skidder, helicopter landings.

Again, the number of plots is found from Table 4-3 (Coast) or 4-5 (Interior), and the minimum number of plots per stratum is two.

The method for selecting the first spot accumulation is to use the date of the month when the surveyor first arrives on site to do the survey.

Example 1:

31 piles requiring 6 plots, surveyed on the 23rd of the month
 $31 / 6 = 5.17$ Survey every 5th pile

Select the following piles: #23, #28, #2, #7, #12, #17

Example 2:

11 piles requiring 3 plots, surveyed on the 30th
 $11 / 3 = 3.67$ Survey every 4th pile

$30 - 11 = 19$; $19 - 11 = 8$

Select the following piles: #8, #1, #5.

4.5 Stratification Procedures for Roadside Accumulations

4.5.1 Roadside Consisting of Strip Accumulations

If the roadside accumulations consist of strips (e.g., windrows), use a rectangular plot which covers the entire width of the strip or a 50 m² circular plot system with plot centres located alternatively at 4 m and 11 m from the roadside, for a 15 m wide strip. Strip accumulations are normally treated as one stratum but may need to be stratified according to different levels of waste or harvesting methods.

4.5.2 Spot Accumulations Resulting From Piling Roadside Slash

Treat all spot accumulations from the same harvesting method in one stratum. The space intervals between spot piles must be treated as a separate roadside stratum.

For roadside piles where plots are established on the side of the pile, the surveyor must alternate locating the plots on the front and back of the piles selected for sampling, if it is safe to work around the back of the pile. If it is not safe to work around the back of the pile, establish the plot on the side of the pile closest to the POC for odd numbered plots and farthest away from the POC for even numbered plots.

Landing accumulations resulting from highlead, helicopter logging, etc., are always stratified separately from the roadside spot accumulations to form their own stratum.

4.5.3 Accumulations Within Dispersed Sub-population

Accumulations found within the dispersed sub-population area which had not been previously stratified will be surveyed as part of the dispersed sub-population and all pieces that fall within a dispersed plot will be measured and recorded.

4.5.4 Debuilt Road

If a road has been debuilt, the logs and stumps pulled back from the side-slopes and scattered over the top of the deactivated road, the debuilt road must be treated as a separate accumulation stratum and sampled accordingly. The stratum code for debuilt roads is WB0X.

Table 4-1 Grid Spacing (GS) Worksheet

LICENSEE:	Date:				
Waste Reporting Unit:					
Option for Measurement (either Cutblock or Aggregate):					
Estimated date of field survey:					
Estimated completion date of Primary Logging:					
Actual completion date of Primary Logging:					
Licence:			Division:		
Forest District:			Region:		
<p>NOTE: Worksheet calculations will be determined upon completion of primary logging for the block. If it is certain no changes will occur in the size of the block when primary logging has been completed, then the worksheet can be submitted in advance to facilitate notice of the waste survey.</p> <p>Formula for Grid Spacing = $\sqrt{10,000 * \frac{ha}{plots}}$</p>					
Column Number	(1)	(2)	(3)	(4)	(5)

CP & Block Number	Block Size (ha)	Plot Requirement from Table or Calculation	Ha/Plot Ratio Col. 1/Col. 2 equals to Col. 3 value	Total m ² of Area in Column 3 Value of Col. 3 *10,000	Grid Spacing (m) $\sqrt{\text{value in Column 4}}$

2003/04

Table 4-2 Coast - Dispersed Area

ESTIMATED MINIMUM NUMBER OF PLOTS (n)*
 TO MEET THE SAMPLING ERROR OBJECTIVE ARE SHOWN IN BODY OF TABLE
 MINIMUM PLOT REQUIREMENT PER STRATUM PER SUB-POPULATION IS TWO (2)
 TABLE BASED ON TOTAL WASTE IN SUB-POPULATION = 5% OF CRUISE VOLUME.**
 -WASTE COMPONENT IN SUB-POPULATION = 3% OF CRUISE VOLUME IN REPORTING UNIT.

SUB - POP AREA IN HECTARES (D)	ESTIMATED COEFFICIENT OF VARIATION % (C.V.)										SAMPLING ERROR % S.E. @ .95
	50	60	70	80	90	100	110	120	130		
1	2	2	2	2	2	2	2	2	2	2	N/A
5	2	2	3	4	4	5	6	7	8	8	N/A
9	3	4	4	6	8	9	11	13	15	15	N/A
11	3	4	6	7	9	11	13	16	18	18	N/A
13	4	5	7	9	11	13	16	18	21	21	N/A
15	4	5	8	10	12	15	18	21	24	24	N/A
17	4	6	9	11	14	17	20	23	27	27	N/A
19	5	7	10	12	16	19	22	26	31	31	N/A
21	5	8	11	14	17	20	25	29	34	34	N/A
23	6	8	12	15	19	22	27	32	37	37	N/A
25	6	9	13	16	20	24	29	35	40	40	38.9
30	7	10	14	18	23	28	34	40	46	46	36.4
35	8	11	15	20	25	31	37	44	51	51	34.6
40	9	12	17	22	27	34	40	48	55	55	33.3
45	9	13	18	23	29	36	43	51	59	59	32.2
50	10	14	19	24	31	38	45	54	63	63	31.4
55	10	15	20	26	32	40	48	56	66	66	30.7
60	11	15	20	27	33	41	49	58	68	68	30.1
70	11	16	22	28	36	44	53	62	73	73	29.3
80	12	17	23	30	37	46	55	65	76	76	28.6
90	12	17	24	31	39	48	58	68	80	80	28.1
100	13	18	24	32	40	49	59	70	82	82	27.6
110	13	18	25	33	41	51	61	72	84	84	27.3
120	13	19	26	33	42	52	62	74	86	86	27
130	13	19	26	34	43	53	64	75	88	88	26.8
140	14	20	27	35	44	54	65	77	92	92	26.6
160	14	20	27	35	45	55	66	79	92	92	26.2
180	14	20	28	36	46	56	68	81	94	94	26.6
200	14	21	28	37	46	57	69	82	96	96	25.8
250	15	21	29	38	48	59	71	85	99	99	25.4
300	15	22	30	39	49	60	73	87	101	101	25.1
350	15	22	30	39	50	61	74	88	103	103	25
400	16	22	30	40	50	62	75	89	104	104	24.8
500	16	23	31	40	51	63	76	90	106	106	24.6
800	16	23	32	41	52	63	78	93	109	109	24.4
1000	16	23	32	42	52	65	79	94	110	110	24.3
1500	16	24	32	42	53	65	80	95	110	110	24.1
2000	17	24	32	42	54	66	80	95	112	112	24.1
3000	17	24	33	43	54	66	80	96	112	112	24
4000	17	24	33	43	54	67	81	96	113	113	24
5000	17	24	33	43	54	67	81	96	113	113	24
7000	17	24	33	43	54	67	81	96	113	113	23.9
10000	17	24	33	43	54	67	81	97	113	113	23.9

* Based on 400 square metre plot size. For a different plot size calculate a new coefficient of variation from the following formula and then determine the probable minimum number of plots needed to achieve the sampling error @ .95 using the new C.V.
 New C.V. = $\sqrt{[(C^2) * (Y/X)]}$
 Where: C = C.V. using old plot size (%)
 Y = old plot size (m²)
 X = new plot size (m²)
 ** Cruise volume in reporting unit = cruise volume per hectare * population area.

Table 4-3 Coast - Accumulation Area

ESTIMATED MINIMUM NUMBER OF PLOTS (n)*
 TO MEET THE SAMPLING ERROR OBJECTIVE ARE SHOWN IN BODY OF TABLE
 MINIMUM PLOT REQUIREMENT PER STRATUM PER SUB-POPULATION IS TWO (2)
 -TABLE BASED ON TOTAL WASTE IN SUB-POPULATION = 9% OF CRUISE VOLUME.**
 -WASTE COMPONENT IN SUB-POPULATION = 5% OF CRUISE VOLUME IN REPORTING UNIT.

SUB - POP AREA IN HECTARES (A)	ESTIMATED COEFFICIENT OF VARIATION % (C.V.)									SAMPLING ERROR % S.E. @ .95
	50	60	70	80	90	100	110	120	130	
0.25	2	2	2	2	2	2	2	2	3	N/A
0.50	2	2	2	2	2	3	3	4	5	N/A
0.75	2	2	2	3	4	4	5	6	7	N/A
1	2	2	3	4	5	6	7	8	9	N/A
1.5	2	3	4	5	7	8	9	11	13	N/A
2	3	4	6	7	9	11	13	15	17	N/A
2.5	4	5	7	9	11	13	16	19	22	N/A
3	4	6	8	10	13	15	19	22	26	55.3
3.5	4	6	8	10	13	15	19	22	26	55.3
4	4	6	8	10	13	16	19	22	26	55.3
4.5	4	6	8	10	13	16	19	22	26	55.3
5	4	6	8	10	13	16	19	22	26	55.3
5.5	4	6	8	10	13	16	19	22	26	55.3
6	4	6	8	10	13	16	19	22	26	55.3
6.5	4	6	8	10	13	16	19	22	26	55.3
7	4	6	8	10	13	16	19	22	26	55.3
7.5	4	6	8	10	13	16	19	22	26	55.3
8	4	6	8	10	13	16	19	23	26	55.3
9	4	6	8	10	13	16	19	23	26	55.3
10	4	6	8	10	13	16	19	23	26	55.3
11	4	6	8	10	13	16	19	23	26	55.3
12	4	6	8	10	13	16	19	23	27	55.3
13	4	6	8	10	13	16	19	23	27	55.3
14	4	6	8	10	13	16	19	23	27	55.3
15	4	6	8	10	13	16	19	23	27	55.3
16	4	6	8	10	13	16	19	23	27	55.3
17	4	6	8	10	13	16	19	23	27	55.3
18	4	6	8	10	13	16	19	23	27	55.3
19	4	6	8	10	13	16	19	23	27	55.3
20	4	6	8	10	13	16	19	23	27	55.3
22	4	6	8	10	13	16	19	23	27	55.3
24	4	6	8	10	13	16	19	23	27	55.3
26	4	6	8	10	13	16	19	23	27	55.3
28	4	6	8	10	13	16	19	23	27	55.3
30	4	6	8	10	13	16	19	23	27	55.3
32	4	6	8	10	13	16	19	23	27	55.3
34	4	6	8	10	13	16	19	23	27	55.3
36	4	6	8	10	13	16	19	23	27	55.3
38	4	6	8	10	13	16	19	23	27	55.3
40	4	6	8	10	13	16	19	23	27	55.3

* Based on 50 square metre plot size. For a different plot size calculate a new coefficient of variation from the following formula and then determine the probable minimum number of plots needed to achieve the sampling error @ .95 using the new C.V.

New C.V. = $\sqrt{[(C^2) * (Y/X)]}$
 Where: C = C.V. using old plot size (%)
 Y = old plot size (m²)
 X = new plot size (m²)

** Cruise volume in reporting unit = cruise volume per hectare * population area.

Table 4-4 Interior - Dispersed Area

ESTIMATED MINIMUM NUMBER OF PLOTS (n)*
 TO MEET THE SAMPLING ERROR OBJECTIVE ARE SHOWN IN BODY OF TABLE
 MINIMUM PLOT REQUIREMENT PER STRATUM PER SUB-POPULATION IS TWO (2)
 -TABLE BASED ON TOTAL WASTE IN SUB-POPULATION = 2% OF CRUISE VOLUME.**
 -WASTE COMPONENT IN SUB-POPULATION = 1% OF CRUISE VOLUME IN REPORTING UNIT.

SUB-POP. AREA IN HECTARES (D)	ESTIMATED COEFFICIENT OF VARIATION % (C.V.)										SAMPLING ERROR % S.E. @ .95
	50	60	70	80	90	100	110	120	130	140	
1	2	2	2	2	2	2	2	2	2	2	N/A
5	2	2	3	3	4	5	6	7	8	8	N/A
9	3	3	5	6	7	9	10	12	14	14	N/A
11	3	4	5	7	9	11	13	15	17	17	N/A
13	3	5	6	8	10	12	15	17	20	20	N/A
15	4	6	7	9	12	14	17	20	23	23	N/A
17	4	6	8	11	13	16	19	23	26	26	N/A
19	5	7	9	12	15	18	22	25	29	29	N/A
21	5	8	10	13	16	20	24	28	32	32	N/A
23	6	8	11	14	18	22	26	31	36	36	N/A
25	6	9	12	15	19	24	28	33	39	39	40
30	7	10	14	18	22	27	32	38	44	44	37.4
35	8	11	15	19	24	29	35	42	49	49	35.5
40	8	12	16	21	26	32	38	45	53	53	34.1
45	9	13	17	22	28	34	41	48	56	56	33.1
50	9	13	18	23	29	36	43	51	60	60	32.2
55	10	14	19	24	31	38	45	54	62	62	31.5
60	10	14	19	25	32	39	47	56	65	65	30.9
70	11	15	21	27	34	42	50	59	69	69	30
80	11	16	22	28	36	44	53	62	73	73	29.3
90	12	17	23	29	37	45	55	65	76	76	28.8
100	12	17	23	30	38	47	57	67	78	78	28.3
110	12	18	24	31	39	48	58	69	80	80	28
120	13	18	24	32	40	49	59	70	82	82	27.8
130	13	18	25	32	41	50	61	72	84	84	27.4
140	13	19	25	33	42	51	62	73	85	85	27.2
160	13	19	26	34	43	52	63	75	88	88	26.9
180	14	19	26	34	44	54	65	77	90	90	26.6
200	14	20	27	35	44	55	66	78	91	91	26.4
250	14	20	28	36	46	56	68	81	94	94	26
300	14	21	28	37	47	58	69	82	97	97	25.8
350	15	21	29	37	47	58	71	83	98	98	25.6
400	15	21	29	38	48	59	71	85	99	99	25.4
500	15	22	30	39	49	60	73	86	101	101	25.2
800	16	22	30	39	50	62	74	89	104	104	25
1000	16	23	31	40	50	62	75	89	105	105	24.9
1500	16	23	31	40	51	63	76	90	106	106	24.7
2000	16	23	31	41	51	63	76	91	107	107	24.7
3000	16	23	31	41	52	64	77	92	107	107	24.6
4000	16	23	31	41	52	64	77	92	108	108	24.6
5000	16	23	31	41	52	64	77	92	108	108	24.5
7000	16	23	31	41	52	64	77	92	108	108	24.5
10000	16	23	31	41	52	64	77	92	108	108	24.5

* Based on 400 square metre plot size. For a different plot size calculate a new coefficient of variation from the following formula and then determine the probable minimum number of plots needed to achieve the sampling error @ .95 using the new C.V.
 New C.V. = $\sqrt{[(C^2) * (Y/X)]}$
 Where: C = C.V. using old plot size (%)
 Y = old plot size (m²)
 X = new plot size (m²)
 ** Cruise volume in reporting unit = cruise volume per hectare * population area.

Table 4-5 Interior - Accumulation Area

ESTIMATED MINIMUM NUMBER OF PLOTS (n)*
 TO MEET THE SAMPLING ERROR OBJECTIVE ARE SHOWN IN BODY OF TABLE
 MINIMUM PLOT REQUIREMENT PER STRATUM PER SUB-POPULATION IS TWO (2)
 -TABLE BASED ON TOTAL WASTE IN SUB-POPULATION = 15% OF CRUISE VOLUME.**
 -WASTE COMPONENT IN SUB-POPULATION = 9% OF CRUISE VOLUME IN REPORTING UNIT.

SUB-POP. AREA IN HECTARES (A)	ESTIMATED COEFFICIENT OF VARIATION % (C.V.)										SAMPLING ERROR % S.E. @ .95
	50	60	70	80	90	100	110	120	130		
0.25	2	2	2	2	2	2	2	2	3	N/A	
0.50	2	2	2	2	3	3	4	4	5	N/A	
0.75	2	2	3	3	4	5	6	7	8	N/A	
1	2	3	3	4	5	6	7	9	10	N/A	
1.5	3	4	5	6	7	9	11	13	15	N/A	
2	4	5	6	8	10	12	14	17	20	N/A	
2.5	4	6	8	10	12	15	18	21	24	N/A	
3	5	7	9	12	14	18	21	25	29	52	
3.5	5	7	9	12	15	18	21	25	29	52	
4	5	7	9	12	15	18	21	25	29	52	
4.5	5	7	9	12	15	18	21	25	29	52	
5	5	7	9	12	15	18	22	25	29	52	
5.5	5	7	9	12	15	18	22	25	29	52	
6	5	7	9	12	15	18	22	25	30	52	
6.5	5	7	9	12	15	18	22	25	30	52	
7	5	7	9	12	15	18	22	25	30	52	
7.5	5	7	9	12	15	18	22	25	30	52	
8	5	7	9	12	15	18	22	25	30	52	
9	5	7	9	12	15	18	22	25	30	52	
10	5	7	9	12	15	18	22	25	30	52	
11	5	7	9	12	15	18	22	26	30	52	
12	5	7	9	12	15	18	22	26	30	52	
13	5	7	9	12	15	18	22	26	30	52	
14	5	7	9	12	15	18	22	26	30	52	
15	5	7	9	12	15	18	22	26	30	52	
16	5	7	9	12	15	18	22	26	30	52	
17	5	7	9	12	15	18	22	26	30	52	
18	5	7	9	12	15	18	22	26	30	52	
19	5	7	9	12	15	18	22	26	30	52	
20	5	7	9	12	15	18	22	26	30	52	
22	5	7	9	12	15	18	22	26	30	52	
24	5	7	9	12	15	18	22	26	30	52	
26	5	7	9	12	15	18	22	26	30	52	
28	5	7	9	12	15	18	22	26	30	52	
30	5	7	9	12	15	18	22	26	30	52	
32	5	7	9	12	15	18	22	26	30	52	
34	5	7	9	12	15	18	22	26	30	52	
36	5	7	9	12	15	18	22	26	30	52	
38	5	7	9	12	15	18	22	26	30	52	
40	5	7	9	12	15	18	22	26	30	52	

* Based on 50 square metre plot size. For a different plot size calculate a new coefficient of variation from the following formula and then determine the probable minimum number of plots needed to achieve the sampling error @ .95 using the new C.V.
 New C.V.= $\sqrt{[(C^2) * (Y/X)]}$
 Where: C = C.V. using old plot size (%)
 Y = old plot size (m²)
 X = new plot size (m²)
 ** Cruise volume in reporting unit = cruise volume per hectare (V) * population area (H).

4.6 Road Rights-of-Way

4.6.1 Reporting

Waste assessments are required on road rights-of-way. Licensees must ensure the waste reported on the road rights-of-way is attributed to the correct timber mark or road permit mark. If a road belongs to a Master Road Permit, then the Master Road Permit mark shall be used.

4.6.2 Procedures

The road right-of-way is the access road leading into the waste assessment area from the closest previously logged waste assessment area or the preceding road junction with the main road. There are two surveying options:

1. No plot sampling is required. The area of the road right-of-way area (from edge of the travelled surface to edge of the timber) is included with the dispersed sub-population area of the waste assessment area.
2. Sample with plots (usually 50 m²) in a separate roadside stratum. The stratum code to be used is OT0X.

The procedure for locating the plots is to start from the POC for the waste assessment area (where the road enters the waste assessment area) and put in rectangular plots covering the width of the area between the edge of the road and the edge of the timber using the right hand rule.

4.7 Partial Cutting (Variable Retention) Waste Assessment Areas

Partial cutting (variable retention) waste assessment areas contain leave trees in groups (over 0.25 ha in size is termed group retention) and/or as dispersed individual trees or small groups of a few trees (dispersed retention).

It is important that a proper map of the waste assessment area which shows leave areas and corridors be obtained and used as the Block Survey Plan.

For full surveys, proper stratification of the waste assessment area is required. Leave areas and corridors should be stratified out. Any stratum that has trees removed must be sampled.

New stratum codes for variable retention waste assessment areas have been created, and they are “G” for group retention, and “D” for dispersed retention. The use of smaller than 400 m² plot size is permitted for these strata. If a smaller plot size is used, the C.V. must be recalculated and adjusted using the formula indicated in the bottom of the plot tables.

5 Field Procedures

This manual chapter assumes the waste surveyor is knowledgeable in the principles of sampling and surveying and is familiar with log scaling and grading procedures.

If there are uncertainties over any aspect of the field procedures, waste surveyors are encouraged to direct questions to the district, regional or branch staff.

5.1 General Requirements

5.1.1 Material to be Measured

5.1.1.1 Plot Surveys

All waste volumes within the plot boundaries must be measured and recorded according to the *Timber Merchantability Specifications* specified in this manual.

For pieces that lie across the plot boundary, record the in-plot portion only but classify (kind, waste class, grade) based on the entire piece as if it were completely within the plot.

All coniferous and deciduous timber except reserved timber which is within the specifications of Timber Merchantability described in this manual must be measured and recorded.

5.1.1.2 Road Deactivation Material

Road deactivation material is timber previously used in the construction of a culvert, bridge or a right-of-way which has since been deactivated.

At the time of a waste assessment, all road deactivated material that has not been previously scaled must be included in the waste assessment. All road material must be one hundred percent measured unless it is unsafe, then the volume may be estimated using an accepted method.

5.1.1.3 Decked Timber

Decked timber is five or more logs that are mechanically placed together in a deck.

If a forest officer determines that a log deck is to be scaled at a scale site or field scaled, the log deck must be clearly marked and identified by the licensee in order that the timber in the log deck will not be included in the waste assessment.

For decked timber that is to be included in a waste assessment, the logs must be 100 % measured or estimated using the most practical method as determined by the licensed surveyor such as top scale or average piece size times number of pieces.

5.1.2 Recording Standards

To measure waste material, follow the rules in the Ministry of Forests, Lands Natural Resource Operations and Rural Development *Scaling Manual* except where otherwise described in this manual.

Record the (inside bark) gross dimensions of each piece including rot or other defects. In addition, the waste surveyor calculates the volume deductions for any defects and records the deduction equivalent under "Deduction for Rot/Holes" in rads and/or metres, along with the most appropriate "decay type."

When netting-down the dimensions of a log because of defect, the gross length will be used to determine if the piece meets the 3 m minimum log length. Therefore, the net length of a log used for volume calculations can be less than 3 m.

Record gross length measurements to the nearest one-tenth (0.1) of a metre and gross diameter measurements in radius class units (rads, 1 rad = 2 cm). Record deductions in length to the nearest one-tenth (0.1) of a metre and deductions in radius to the nearest rad.

Top measurements on logs which have very little taper must be made carefully, due to the length of merchantable wood involved between radius classes. For oversized tops, the measurement is to be made at the last occurrence (i.e., uppermost on the tree) of the applicable timber merchantability top dimension specification. When using a scale stick, for a 10 cm top, it will be the mid-point of the 5 radius class. For a 15 cm top, it will be the line separating the 7 and the 8 radius class. All measurements are inside bark.

The measurement of the portion of borderline pieces outside the plot may be recorded but are not mandatory. The minimum requirement will be the measurements of the portions of the pieces within the plot, together with a code (when needed) that will override computer checks on minimum log length.

Detailed measurement protocol and standards are included later in this chapter.

5.1.3 Waste Class

Waste classification must not be biased for any reason such as accommodating inadequate planning and supervision, poor harvesting methods, inadequate/careless logging practices or a licensee's own manufacturing or market specifications.

All waste must be classified as either avoidable or unavoidable.

Unavoidable volumes are those which cannot be removed because of physical impediments, safety considerations, or environmental constraints.

By definition, all other volumes are *avoidable*.

5.1.3.1 Some Unavoidable Examples

1. Due to physical impediments:
 - a. logs wedged between boulders, or
 - b. a log stranded on a ledge.
2. Due to safety:
 - a. the portion of a high stump (with a rock against it) between the maximum allowable stump height and the height where the stump could have been safely cut (Figure 5.4),
 - b. logs with shards of imbedded rock from blasting (Section 5.3.10),
 - c. log pieces that were cut to create escape paths for the fallers (Section 5.3.4.2),
 - d. bucking waste with severe deformities as outlined in Figure 5.3.5.1, or
 - e. logs that are unsafe to remove due to site specific circumstances.
3. Due to environmental constraint:
 - a. a log if removed will cause excessive site disturbance or soil degradations, or
 - b. approved high stumps due to snowpack (Section 5.3.4.4),
 - c. stub trees to be used for biodiversity purposes.

5.1.3.2 Piece Numbers

Waste pieces are usually recorded with one set of measurements.

However, where high stumps or forks are found, the piece may have both avoidable and unavoidable segments.

In these situations, the segments are recorded separately, *each with its own piece number*. Record MP on the comment column of FS 161 to indicate multiple pieces. Mark all pieces measured in the plot clearly with the piece number, using tree marking paint.

5.1.5 Grading Pieces

Log pieces must be graded according to the rules in the *Scaling Manual* except where the waste rules are different and then waste rules are used.

For example the minimum log length for waste is 3 m instead of the 2.5 m in the *Scaling Manual*.

For more information on the grading rules see the *Scaling Manual*.

On the coast, due to the timber pricing changes made to Hemlock, Balsam U and X grades for all coniferous species, refer to Appendix 6 on how to grade bucking waste, stumps, logs and standing trees.

When the waste assessment of a waste assessment area has not been conducted within the allowable time frame, log pieces must be graded according to their conditions (i.e., grade and decay) at the time the waste survey should have been conducted.

5.1.6 Visual Estimates

If loose debris cannot be quickly moved away to facilitate measurements in dispersed plots, or if logs and/or branches in landings prevent measuring one of the ends or the length of a log, visually estimate the missing dimension. In order to correctly establish the grade, at least one end must be visible or the piece should not be recorded.

5.1.7 Measure Factor

In deep accumulations, it may not be possible to measure or visually estimate each piece. In these cases, first measure and/or visually estimate the material that is accessible.

Then, project the plot boundaries down to the ground and visually estimate what portion of the volumes within the plot boundaries were measured. Record this portion on the plot tally card under "measure %."

This percent is known as the "Measure Factor", and is only applied to the plot method.

Measure as many pieces as possible, even when some dimensions of an individual piece must be estimated.

In the example below: If you were able to measure down approximately 2 m, you would record a measure factor of 40 percent providing that the volumes of waste were spread evenly through the cylinder within the plot boundaries. The measure factor is derived from $2\text{m}/5\text{m} \times 100\% = 40\%$.

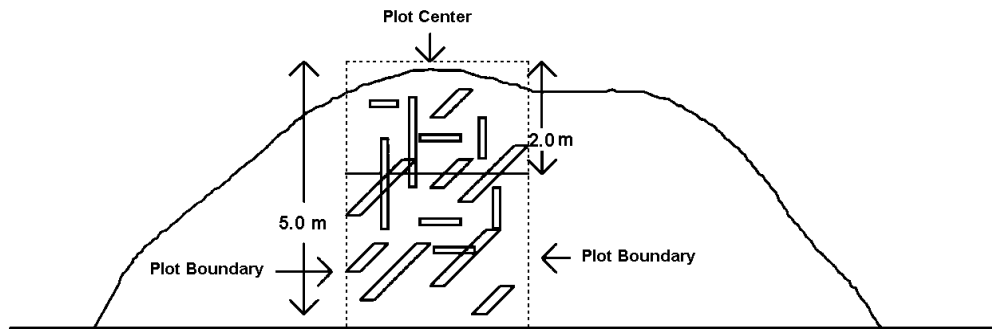

Figure 5-1 Measure Factor

5.1.8 Deductions for Rot

For material containing rot, measure and record the gross dimensions of the piece (actual size) including rot. In addition, surveyor calculates the volume deduction for rot but records the deduction equivalent in rads and/or metres, along with the most appropriate "decay type".

5.1.9 Waste Survey Safety Procedures

In accordance with Section 3.12(1) of the Occupational Health and Safety Regulation - "A person **must not** carry out or cause to be carried out any work process or operate or cause to be operated any tool, appliance or equipment if that person has reasonable cause to believe that to do so would create an undue hazard to the health and safety of any person."

The objective of this section is to provide an alternative method of determining waste volumes where a portion or the entire plot or block cannot be measured safely.

1. Where a piece or portion of a plot or an entire plot cannot be measured safely, attempt to complete the piece or plot through estimation from a nearby location.
2. Where the plot cannot be measured or estimated safely, move the plot to a safe location as specified in Section 5.2.3 up to a maximum of 48 meters. If there is no safe location within 48m, drop the plot.
3. When a plot must be dropped for safety, use replacement data of an existing plot from the same cut block or license that has similar waste levels, species and grade profile, age and method of harvesting. The surveyor may have to use a measure factor to adjust the volume to make it representative of the actual waste levels.

If replacement data from another plot is used, ensure the volume is the same or less of the dropped plot. If the volume is less, then apply the measure factor to increase the waste volume to the appropriate level. The waste system cannot reduce a plot volume; therefore, assigning a measure factor greater than 100% will not work.

4. Where more than half of the plots cannot be established safely, the waste volumes on the waste assessment area can be determined using the Block Exemption or Ocular Estimate method.

5.2 Plot Establishment

All P.O.Cs and tie points should be marked with aluminum tags and either flagging ribbon or high-visibility paint and be easily observed from access roads.

Plot centres are to be marked with a sturdy stake driven well into the ground and made clearly visible with paint or surveyors flagging ribbon and identified with waterproof felt pen or aluminum tags.

Plot boundaries are to be clearly marked on all borderline pieces with paint.

Plot boundaries are to be measured from the point where the plot stake enters the ground.

Recorded pieces are to be clearly numbered with tree marking paint.

The formula for calculating the horizontal radius of a circular plot is:

$$\sqrt{[\text{plot size in m}^2 / \pi]}$$

Any odd shaped accumulations may be sampled with a long rectangular plot or strip so long as the plot size is consistent within the stratum.

All distances (between plots etc. and plot radii) are to be corrected for slope and must be measured to the standards listed in Chapter 6. The formula used to correct for slope is:

$$\text{COS} [\text{Tan}^{-1} (\text{slope \%}/100)]$$

The inverse of this number is multiplied by the plot radius to obtain the corrected slope distance.

e.g. slope of 74% and plot radius of 11.28m

$$\text{COS} [\text{Tan}^{-1} (74/100)] = 0.8038 \qquad 0.8038^{-1} = 1.2441$$

$$1.2441 \times 11.28\text{m} = 14.03 \text{ m Slope distance}$$

Table 5-1 following contains the corrected slope distance for a 11.28 m plot radius (400 m² plot).

Table 5-1 Slope Distances for 11.28 m Plot Radius

5% - 11.29 m	39% - 12.11 m	73% - 13.97 m
6% - 11.30 m	40% - 12.15 m	74% - 14.03 m
7% - 11.31 m	41% - 12.19 m	75% - 14.10 m
8% - 11.32 m	42% - 12.23 m	76% - 14.17 m
9% - 11.33 m	43% - 12.28 m	77% - 14.24 m
10% - 11.34 m	44% - 12.32 m	78% - 14.31 m
11% - 11.35 m	45% - 12.37 m	79% - 14.38 m
12% - 11.36 m	46% - 12.42 m	80% - 14.45 m
13% - 11.38 m	47% - 12.46 m	81% - 14.52 m
14% - 11.39 m	48% - 12.51 m	82% - 14.59 m
15% - 11.41 m	49% - 12.56 m	83% - 14.66 m
16% - 11.42 m	50% - 12.61 m	84% - 14.73 m
17% - 11.44 m	51% - 12.66 m	85% - 14.80 m
18% - 11.46 m	52% - 12.71 m	86% - 14.88 m
19% - 11.48 m	53% - 12.77 m	87% - 14.95 m
20% - 11.50 m	54% - 12.82 m	88% - 15.03 m
21% - 11.53 m	55% - 12.87 m	89% - 15.10 m
22% - 11.55 m	56% - 12.93 m	90% - 15.18 m
23% - 11.58 m	57% - 12.98 m	91% - 15.25 m
24% - 11.60 m	58% - 13.04 m	92% - 15.33 m
25% - 11.63 m	59% - 13.10 m	93% - 15.40 m
26% - 11.66 m	60% - 13.16 m	94% - 15.49 m
27% - 11.68 m	61% - 13.21 m	95% - 15.56 m
28% - 11.71 m	62% - 13.27 m	96% - 15.64 m
29% - 11.75 m	63% - 13.33 m	97% - 15.71 m
30% - 11.78 m	64% - 13.39 m	98% - 15.79 m
31% - 11.81 m	65% - 13.45 m	99% - 15.87 m
32% - 11.84 m	66% - 13.52 m	100% - 15.95 m
33% - 11.88 m	67% - 13.58 m	110% - 16.77 m
34% - 11.91 m	68% - 13.64 m	120% - 17.62 m
35% - 11.95 m	69% - 13.71 m	130% - 18.50 m
36% - 11.99 m	70% - 13.77 m	140% - 19.40 m
37% - 12.03 m	71% - 13.83 m	150% - 20.34 m
38% - 12.07 m	72% - 13.90 m	

5.2.1 Locating Landing Plots

Landing plots are located on a line starting from the geographic centre of the landing. Mark the centre of the landing (with orange ribbon or paint) so that the check surveyor will be able to find your P.O.C.

The first line is always run north from your P.O.C.

A plot is located at mid distance between the points where the line enters and exits the accumulation. This distance must be at least twice the plot radius because the plot must fall completely within the accumulation.

If a circular plot cannot be established on the North bearing, try East, then South, then West. If a circular plot cannot be established on these bearings try N45E, S45E, S45W and N45W consecutively. If a circular plot still cannot be established try N22.5E, N67.5E, S67.5E, S22.5E, S22.5W, S67.5W, N67.5W and N22.5W consecutively around the compass.

If a circular plot still cannot be established using the smallest plot size available (50m² - 3.99 m radius) then a rectangular plot can be established or 100 percent of the pile measured.

In blocks where there is only one landing or one landing that is safe to work on the minimum of two plots must still be established so a landing may have to have more than one plot established on it. In this case distribute the plots as evenly as possible over the accumulation(s).

This procedure is auditable so the plot must be established at the first successful attempt using the sequence of steps listed above.

5.2.2 Locating Dispersed Plots

Dispersed plots are to be located on a systematic staggered grid as per the Block Survey Plan drawn up for the block. See Plot Layout-Dispersed in Section 4.4.1.

5.2.3 Moving Dispersed Plots

5.2.3.1 Using Border Plots

If the dispersed plot centre falls within the stratum to be sampled but a 400 m² circular plot cannot be established because part of the plot falls outside the stratum, establish a 400 m² half circular plot (15.96 m radius).

To establish a plot proceed the shortest possible distance to the edge of the stratum, measure 3 m in each direction along the edge of the stratum and take a compass bearing between the two points. This compass bearing will be used, from plot centre, to determine the split line (boundary) of the half-circle plot.

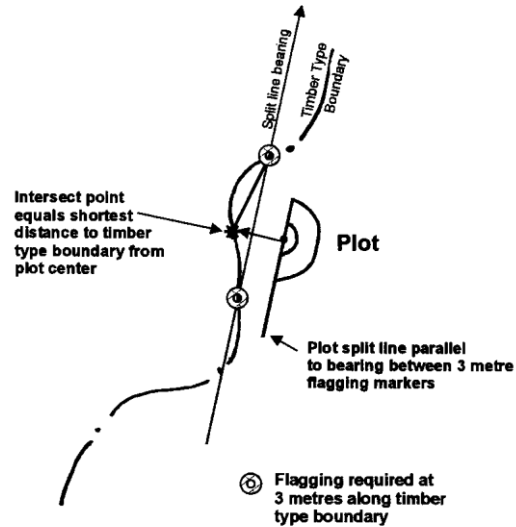

Figure 5-2 Border Plot

If a 400 m² half-circle plot (15.96 m radius) cannot be established without sampling outside of the stratum, move the plot as per Section 5.2.3.2.

5.2.3.2 Using Compass

Dispersed plots that fall outside the type stratum they were intended to sample are to be moved in a consistent and therefore auditable manner. The procedures for moving plots are as follows:

1. Move the plot North one plot radius (12 m) to establish either a full circle plot or a half circle (border) plot. If this fails, try East with the same distance and procedure, then South, then West.
2. If the above fails, repeat the same procedure but increase the distance by 12 m increments. A plot must be established at the first possible location.

Never move a plot that falls completely within the stratum it was intended to sample. stratum can be defined in advance of the fieldwork.

For example, roadside accumulations are often defined as 10 m wide and along both sides of the roads throughout the entire block.

If a large volume has slid down a steep slope from a roadside accumulation and a dispersed plot lands on the pile, that is where it must stay so long as the outside edge of the dispersed plot does not fall within the predetermined width of the roadside accumulation. Again, unless that pile were previously delineated and removed from the dispersed area, it is part of the dispersed sub-population.

Gravel pits and large swamps should be typed out and plots which fall on these locations must be moved to a spot within a type stratum.

Therefore, typing is *very* important to obtain reliable estimates.

5.2.4 Plot Sizes

Plots in dispersed slash must be circular and may not be smaller than 400 m² (11.28 m in radius) unless the block is a Variable Retention (partial logging) waste assessment area under Section

4.7. Plots in accumulations may be rectangular or circular and may be as small as 50 m² (3.99 m in radius) or rectangular (i.e., 5 m x 10 m). The formula for calculating the horizontal plot radius is: SQR (plot size in m² / PI), where SQR means "the square root of", and PI means 3.1415927.

Different plot sizes may be used for different stratum but once a plot size has been chosen it cannot be changed (i.e., all plots within a stratum must be the same size).

Recommended plot sizes and shapes are as follows:

Open slash	400 m ² round (radius = 11.28 m)
Felled and bucked	400 m ² round (radius = 11.28 m) or 100 percent scale if area is small
Accumulations	50 m ² round (radius = 3.99 m) or rectangular (i.e., 5 m x 10 m)
Roadside accumulations	200 m ² rectangular (i.e., 10 m x 20 m where 10 m is the average width of the roadside accumulation). 100 m ² rectangular. 50 m ² rectangular (for strips 10 m wide or less). 50 m ² circular (for a 15 m wide strip, locate plot centres alternatively at 4 m and 11 m from the roadside).

For fixed width roadside stratum that are over 15 m wide, rectangular plots must be used and the minimum acceptable size is 50 m². Each plot must cover half the width of the stratum by the distance required to make the plot size. The plots will be staggered with the odd number plots covering the outside half of the stratum and the even number of plots covering the inside half (i.e., for a 20 m wide stratum each plot would be 10 m wide by 5 m long). Alternatively, 100 m² rectangular plots covering the entire width of the stratum are acceptable.

For varying width stratum, map the width of the stratum every 25 m along the road. Rectangular plots (which cover the entire width of the stratum where the plot is located) must be used. The minimum acceptable plot size is 100 m² unless the maximum width of the stratum is 10 m or less and then 50 m² plots are acceptable (i.e., for a 18 m wide stratum use an 18 m by 5.56 m plot).

5.3 Kind of Material

5.3.1 Logs

A log is defined as any near-round piece with more than half of its *original circumference* remaining and with an average diameter equal to or larger than the timber merchantability specification diameter for at least 3 m of length.

Logs are measured in accordance with the *Scaling Manual* and *Scaling Regulation*, with some exceptions, as specified in this manual.

Measure the diameter to the nearest radius class unit on the scale stick (1 rad = 2 cm) and measure the length to the nearest 0.1 m (i.e., nearest decimetre).

"Log length" is the length that a scaler records to accurately determine the gross volume of the piece; i.e., without making any deductions for rot.

A broken top piece is measured from the top contractual diameter, and then a length deduction (from the diameter to the XY line) is applied to account for the missing wood, as illustrated in Section 5.5.1.1 (Figure 5.10).

In a waste survey, the term "logs" encompasses all down logs, slabs, that are a minimum of 3 m in length with a top diameter of 10 cm or 15 cm. Record as "L" under "Kind of Material" on the plot survey card (FS 161).

5.3.2 Trees

Trees left standing after timber harvesting that are not reserved for silviculture, biodiversity or a forest management reason are measured in a waste assessment and classified as avoidable or unavoidable waste.

Appropriate documents such as tenure licence documents, timber appraisal applications and maps need to be referenced to determine the conifer and/or deciduous leaf trees identified by species to be retained as reserved timber for the waste assessment area being waste assessed. These specifications apply to trees outside of the mapped wildlife tree patches.

In all cases, a document detailing the post harvest standing tree specifications must be submitted into the Waste System and updated documents (maps, etc.) must be provided to the waste surveyor.

For cutting authorities requiring a post harvest appraisal data submission under the *Coast Appraisal Manual*, when a waste assessment area contains standing timber, the post harvest standing tree specifications must be documented in an assurance statement prepared by a forest professional. For cutting authorities that have not been submitted into the Electronic Commerce Appraisal System (ECAS), this document must confirm:

- 1. If standing timber is to be excluded from the net cruise volume of the post harvest appraisal data submission, and that standing timber is not to be tallied, or**
- 2. If standing timber is to be tallied as waste and contain a description of the standing timber characteristics.**

When a post harvest appraisal data submission has been completed in ECAS, the waste assessment must align with the information contained within that submission.

5.3.2.1 Clearcut

Individual standing tree volumes that are measured must be kept separate from the plot waste volumes. Standing tree dimensions are recorded using FS 161, Waste Survey Plot Tally. Trees that were left scattered sparingly throughout the waste assessment area are measured individually and each tree is numbered and marked with paint. Record the timber merchantability specification top diameter in rads as the top diameter. The length is determined using a tape/chain and a clinometer or an electronic measuring device such as a laser instrument. The waste surveyor visually estimates the location of the top diameter and then measures the length from this point down to the timber merchantability stump height (must make a 3 m log that meets the timber merchantability specifications).

If the top is broken, the waste surveyor visually estimates the diameter at the break, and measures the length from the break mid-point to the stump height. The butt diameter is obtained by measuring the tree diameter at the timber merchantability specification stump height, accounting for flare.

On the FS 161, under Kind, record T for standing trees or D for downed trees, classify the trees as avoidable or unavoidable. Enter the dimensions for length, top and butt diameters, end codes, and assign a log grade.

One possible method for determining the volume of standing trees is to record the species and diameter of each tree and use the Extended Type Stand and Stock Table from the timber cruise compilation.

For trees that were left in a large patch where individual tree measurement is impractical, the waste surveyor will perform a closed traverse measuring the precise area represented by the tree patch. The cruise net volume per hectare (for that timber type(s)) will be used to determine the volume of timber in the tree patch that was not harvested. A patch is defined to be a grouping of trees occupying an area of more than one hectare. For a patch that is less than one hectare, a surveyor may apply the cruise net average or opt for individual tree measurement.

For scattered standing trees, the standing tree areas must be properly stratified. Plots will be allowed but the block must be surveyed using the Cutblock option.

Except for individual standing or downed trees where each tree is individually graded, the species and grade allocations for large tree patches left in clearcuts, are based on the cruise compilation information for the cutblock being waste assessed. Alternately, the historic billing grade profile of the timber mark for the cutting authority may be used when a cruise compilation is not available.

If a forest professional considers the historical records or cruise compilation information to be unrepresentative of the grade profile on site, grades may be derived by an RPF or RFT based on examinations of the actual grade compositions of the stand left on site.

5.3.2.2 Partial Cut

Timber volume that is left in excess of the leave volume **and is not, or will not be, excluded in a post harvest appraisal data submission for the cutting authority** will be billed as waste subject to the application of the waste benchmarks.

Surveyors should reference appropriate documents that provide the volume percent reduction by either one or more of species, timber type, risk group/tree class or treatment unit for each individual waste assessment area within the cutting permit or agreement.

There are at least two methods **for determining the unharvested standing tree volume in a partial cut – by re-cruising the waste assessment area, or by tallying the standing timber in** fixed area waste plots. Choose a method that is appropriate for the waste assessment area.

1. For a re-cruise, a licensee must strive to put in a sufficient number of cruise plots that will either **achieve the sampling error objective as stated in the *Cruising Manual*, or meet the conditions required to waive it.**
2. If waste plots are used, the plot size should be 400 m². A licensee must strive to put in a sufficient number of waste plots that will meet or exceed the sampling error objective approved for the reporting unit. The minimum sampling intensity required is at least two plots per stratum or if the waste assessment area is not stratified, two plots per waste assessment area.

Except when waste plots are used, once the unharvested standing tree volume has been derived, the **species and** grade allocations are based on the **re-cruise compilation information for the cutblock being waste assessed**. **Alternately**, the historic billing grade profile of the timber mark for the cutting authority **may be used when a cruise compilation is not available**.

If a **forest professional** considers the historical records **or cruise compilation information to be** unrepresentative of the grade profile on site, grades may be derived by an RPF or RFT based on examinations of the actual grade compositions of the stand left on site.

The survey results for waste assessment areas that have been harvested using partial cut systems must be **submitted or** sponsored by an RPF or RFT **in the Waste System**. This is to confirm that the partial cut timber harvesting requirements that were previously stated in **the** Schedule B or the Percent Reduction Report in the appraisal cruise compilation submission have been met and there are no waste billing concerns on the remaining standing tree volumes.

If a field or office review by ministry staff identifies an apparent discrepancy with the species or volume harvested, the licensee or the TSM may be directed by the District Manager to re-cruise or resurvey the residual standing trees.

5.3.2.3 Unharvested Cutblocks

An unharvested cutblock in an expired, surrendered or cancelled cutting permit or authority where harvest has occurred on the cutting authority will be billed as waste unless:

1. A waste relief application has been approved, or
2. The cutblock contains only standing timber and is removed from the net cruise volume in the cutting authority in the post harvest appraisal data submission.

The billings will be made on the basis of the net cruise volume attributed to the unharvested cutblock.

Once the net cruise volume is determined, the grade allocations will be based on the cruise compilation for the unharvested cutblock or by using the historic billing grade profile of the timber mark for the cutting authority. Only in the absence of the billing history records, or if a forest professional considers the records are unrepresentative, grades may be derived by a forest professional based on examinations of the actual grade compositions of the stand left on site.

5.3.2.4 Tabular Stumpage Rates

1. This section only applies to cutblocks where primary logging is completed on or after November 1, 2009.
2. Subject to subsection (3) of this section, and notwithstanding sections 5.3.2, 5.3.2.1 and 5.3.2.2 of this manual, where a stumpage rate for a cutting authority must be determined under Section 6.1.1, or Section 6.1.2 of the *Interior Appraisal Manual*, or Section 7.2 of the *Coast Appraisal Manual*, timber left standing on the cutting authority area after primary logging has been completed will not be measured nor billed as waste.
3. Where the District Manager determines that the holder of the agreement failed to harvest the standing timber in accordance with:
 - a. the results or strategies of a Forest Stewardship Plan, or the default or alternative performance requirements that pertain to the agreement, or
 - b. the results, strategies, or the measures of a Woodlot Licence Plan that pertain to the agreement,

the District Manager may require the holder of the cutting authority to conduct a waste assessment of the standing timber and will bill this residual timber on the cutting authority area as avoidable waste.

4. Subsections (2) and (3) apply to standing timber only, a waste assessment of the dispersed and accumulated subpopulations of the cutblock must be conducted as per this manual's requirements.

5.3.3 Slabs

A slab is defined as any non-round piece with less than half (1/2) of its original circumference remaining, a minimum thickness of 10 cm and an average diameter equal to or larger than the timber merchantability specification diameter. The *only* exception is mature red cedar (on the Coast only) which must have a minimum thickness of 15 cm to be measured or recorded.

Slabs are measured, graded and recorded as a “Log” (L) if they have a minimum thickness of at least 10 cm for at least 3 m in length or as “Bucking Waste” (W) if they are bucked at the butt end or both ends and have a minimum thickness of a least 10 cm for less than 3 m but at least a tenth (0.1) of a metre.

Chapter 5 of the *Scaling Manual* should be referred to for measurement procedures for slab ends in various shapes (i.e., semi-circle, quadrant, sector, segment, etc).

Alternatively, the following method is continuously accepted for computing slab diameters, for waste purposes.

Using Figure 5.3, slab diameters are computed using the following steps:

1. Measure and average 3 thickness.
i.e., $11 + 9 + 13 = 33/3 = 11$ rads
2. Measure 1 width between 5 rades.
i.e., Width = 31 rads
3. Average the thickness and the width.
i.e., $11 + 31 = 42/2 = 21$ rads*

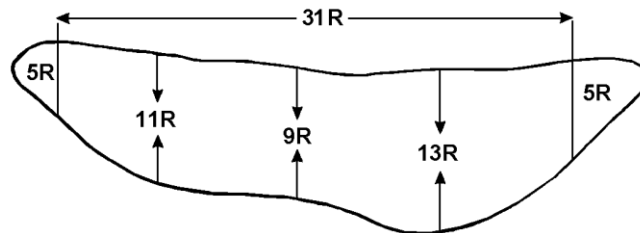

Figure 5-3 Measuring Slabs

5.3.4 Stumps

A stump is defined as any piece with more than half (1/2) of its original circumference remaining, less than 3.3 m in length and still attached to the roots. The length is to be measured from the high side of the stump. A stump that is at least 3 m in length after the maximum allowable stump height (usually 30 cm) has been deducted is classified as a log because of its length.

Stump heights are always measured from the high side.

Stump height *is not* measured from the top of any root flare or any obstacles such as accumulated bark, moss, or other loose duff and vegetation that could be kicked away easily by the faller. No consideration should be given to brush and undergrowth that the faller should cut away before falling.

Measure from where the ground meets the base of the stem to the top of the felling cut (as shown in Figure 5.4) to the nearest tenth (0.1) of a metre. The volume of the undercut is included in the measured stump volume. Deduct the stump height of 0.3 m and record the result under length on the FS 161.

If the total stump height is less than or equal to the stump height of 0.3 m measured from the high side, then the stump *does not have to be recorded*.

For raised stumps where the tree has grown out of a rotten log, the stump height should be measured from the point of germination, or the high side, whichever is higher.

Stumps will not normally be graded and will default to sawlog grade. However, if the log from the stump is present the stump should be graded the same as the log.

If the stump has less than 50 percent firmwood volume, the stump is not recorded.

In the Interior, dead stumps will only be measured and recorded where the timber stand is designated to be catastrophic.

On the Coast, dead stumps will not be measured nor recorded except cedar, cypress and white pine. Use the following guidelines to differentiate between dead/live stumps:

Dead	considerable crumbling sap rot and/or loose or missing bark.
Live	little or no crumbling sap rot and bark not loose.

Sometimes stumps can be broken up in logging. Any stump fragments are ignored. Conversely, any stumps with missing fragments are measured as if the fragment was still in place.

5.3.4.1 Measuring and Recording Stumps

Careful measurement of stumps is critical because they contain high volume per unit of length.

Measure the top diameter (inside bark) of the stump (unless the total height of the stump exceeds 1.3 m) and record it in the "top" column.

For a stump whose total height exceeds 1.3 m, record the diameter (inside bark) at 1.3 m above the ground on the high side of the stump. The taper of the stump should be finished at approximately that point and recording the top diameter above 1.3 m would end up under estimating the volume of the stump.

Stump diameter is always measured inside bark, and recorded to the nearest rad.

No entry is required in either the top or butt end code fields on the FS 161.

5.3.4.2 Waste in Stumps

Unless there are physical obstructions or safety precautions because of decayed wood, waste in stumps is classified as avoidable waste.

Unavoidable waste occurs where excessive snow depth or an obstruction prevents cutting the tree to the timber merchantability specifications. Where there are physical obstructions or excessive snow depth, the lowest height that the tree could have been cut must be established.

Frequently, trees and snags with butt rot are felled above the TMS stump height for safety reasons. Under these circumstances, a stump may have both avoidable and unavoidable components. This situation is illustrated below in Figure 5.4.

The District Manager may approve a higher allowed stump height on all or a portion of the waste assessment area for safety reasons or to hold back logs.

- A. Timber Merchantability Specifications (TMS) Stump Height.
- B. Allowed Stump Height.
- C. Total Stump Height.

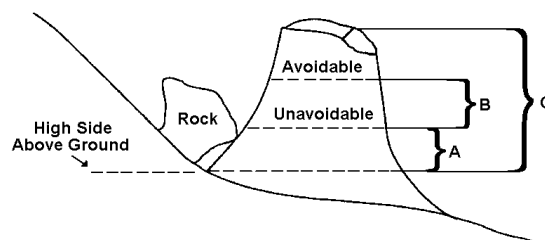

Figure 5-4 Avoidable and Unavoidable Waste (High Side)

5.3.4.2.1 Definitions:

- A. *Timber merchantability specifications (TMS) stump height* of 30 cm is measured from the ground on the *high side*. This part is not recorded. If the stump is higher, length measurements start from the 30 cm mark.
- B. *Allowed stump height* is the height specified in the District Manager's letter for heavy snow packs, or the minimum distance from the ground on the *high side* of a stump up to a point above a physical obstruction which allows for safe falling. B minus A = unavoidable piece.
- C. *Total stump height* is the distance from the ground on the *high side* to the top of the felling cut. C minus B = avoidable piece.

5.3.4.3 Recording Stumps in Segments

If there are both avoidable and unavoidable components of waste, the stump is recorded as two pieces each with its own piece number and record appropriate comment code such as MP on FS 161 to indicate multiple pieces.

Record the top portion as avoidable piece. Enter the difference between the total stump height and the allowed stump height in the length field, and the top radius in the top field. Classify this piece as avoidable (A).

Record the lower portion as unavoidable piece. Enter the difference between the allowed stump height and the TMS stump height in the length field, and the top radius of this lower segment in the top field. Classify this piece as unavoidable (U).

5.3.4.4 High Stumps - Snowpack

Winter logging can result in unavoidable waste occurring in high stumps due to snowpack, especially alongside winter skid trails.

Where winter logging is approved and the TMS stump heights cannot be achieved by operators because of snow conditions, the waste portion is considered avoidable unless a written exemption is issued by the District Manager.

This exemption will specify a new maximum stump height to reflect acceptable winter stump heights.

The portion of the stump between the TMS stump height and the allowed stump height specified in the exemption letter is considered unavoidable.

The portion of the stump above the allowed stump height specified in the exemption letter is considered avoidable.

In all cases, trees must be cut as close to the TMS stump height as possible.

Survey crews must confirm if an exemption letter has been issued prior to the survey.

In addition, the decision to classify stumps as unavoidable because of snow should not be automatic. Prudent operators with a mix of operating areas are expected to avoid high snow areas through sound planning.

5.3.4.5 Blowdown Stumps

It is very difficult to determine whether a stump on a blowdown area is avoidable or unavoidable after the logging has been completed since there could have been a dangerous obstruction that has since been removed.

Safety is the primary consideration for the person cutting the log off a tree that has been blown over. Therefore, if there is any question as to whether the stump should be called avoidable then the waste surveyor should give the licensee the benefit of the doubt and call it unavoidable.

Unavoidable waste in blowdown stumps also occurs in the form of long butts. Where this occurs, as illustrated below in Figure 5.5, the long butt is treated as a stump with the length being measured from the side 30 cm adjacent to high ground.

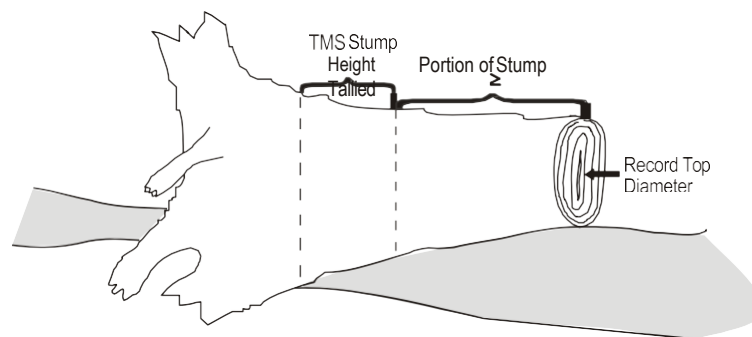

Figure 5-5 Windfall Stump

In some blowdown situations, there may be wind sheared trees resulting in high stumps that could not yield a minimum-length clean log. These stumps are classified as unavoidable, provided that the Forest Service has been advised immediately after the field work for the affected block has been completed. Occasionally, there may be valid safety reasons for leaving a wind sheared high stump that could have yielded a minimum-length log, but normally such high stumps are classified as avoidable.

Unavoidable stumps can also occur when windfalls obstruct the trunks of standing trees preventing lower cuts.

Where feasible, especially where there are many blowdown trees, fallers should consider making their first cut just over one log length from the root wad. The resulting log with the root attached may then be yarded or skidded into the landings and the roots safely cut off.

Blowdown stumps which stand back up when the logs are bucked off should be classified as unavoidable because they were probably cut high for safety reasons.

If bucking could safely produce a minimum length log from such stumps, the volume above the TMS stump height should be recorded as avoidable waste.

Guy line stumps can be accepted as unavoidable if there is no unnecessary waste of wood. Any portion that is excessive waste must be classified as avoidable. Blowdown stumps on a landing should be classified as unavoidable.

5.3.4.6 Borderline Stumps

For borderline stumps, measure the horizontal distance from the plot centre to the geometric centre of the stump at a point 30 cm above the high side. If this point is located inside the plot, the entire stump is recorded. If it is not, the entire stump is not recorded.

For knocked-over and uprooted stumps, measure the horizontal distance from the plot centre to a point 30 cm above the high side or the point of germination (POG), whichever is higher. If this point is located inside the plot, measure the entire stump.

5.3.5 Bucking Waste

Bucking waste is defined as any piece less than 3 m in length (originating from a log at least 3 m in length) that has been cut at the large end or at both ends. It has been cut too short to be of any use through improper or careless bucking practices.

A piece cut at the small end (top) and broken at the large end (butt) is considered unavoidable breakage (not recorded) in the dispersed sub-population but is measured and recorded as bucking waste in accumulation sub-populations. However, if the logging system was inappropriate or there was excessive breakage in the dispersed sub-population then all pieces cut at the small end (top) and broken at the large end (butt) should be recorded as avoidable breakage.

Some examples of bucking waste are when tops are bucked off at a diameter larger than the TMS diameter, when the 0.1 m trim allowance has been exceeded (big end cut and small end broken) and when decay has been bucked off a log and the remaining piece is more than 50 percent sound. Trim ends less than 50 percent sound which are less than the dimensions of a slab need not be measured. Trim ends which are heavily fractured are not to be measured.

Bucking Waste is recorded as "W" under "Kind of Material" on the FS 161 (Plot Survey Card). Bucking waste is normally graded sawlog and can only be downgraded for excessive twists and oversize knots.

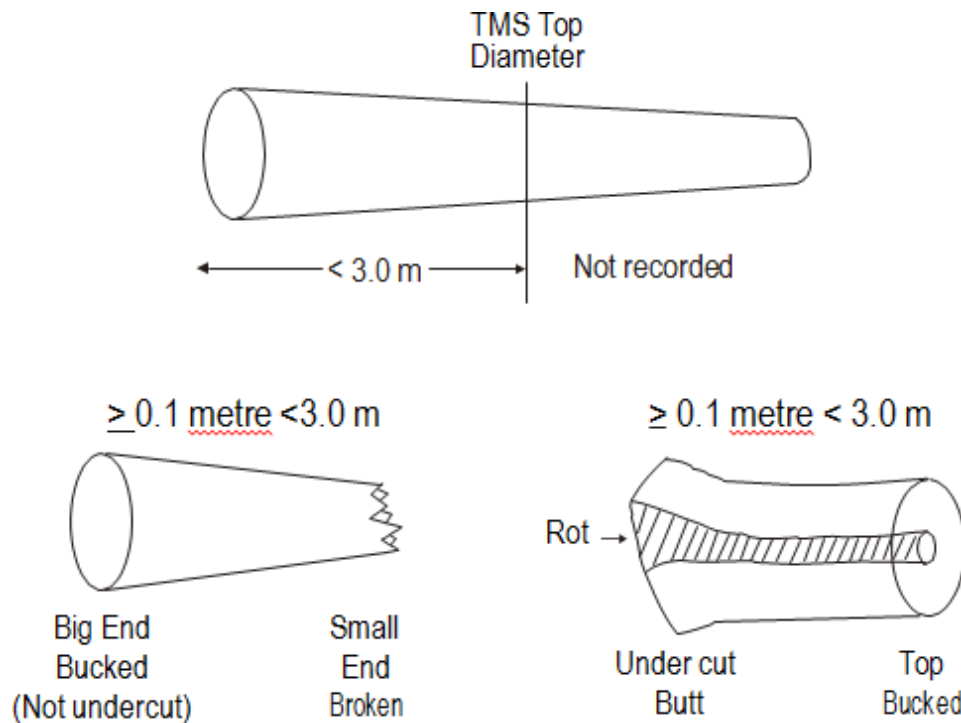

Figure 5-6 Examples of Bucking Waste

5.3.5.1 Avoidable/Unavoidable

Bucking waste is considered avoidable unless there is clear evidence that pieces were cut out for safety reasons in falling (escape path) and bucking (oblique cuts), in which case they may be classified as unavoidable.

Pieces with severe physical deformities such as forks, crooks, pistol butt or extreme sweep, and gall or goitres may be pencil bucked to separate avoidable and unavoidable portions as shown in the examples of pieces under 3 m below.

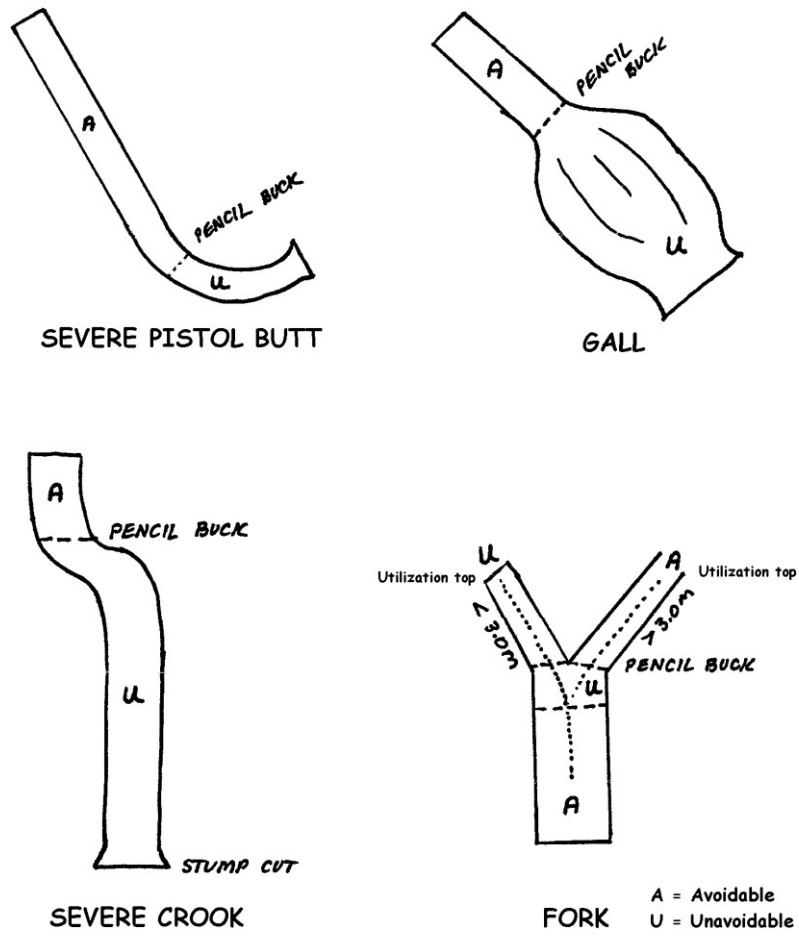

Figure 5-7 Avoidable / Unavoidable Bucking Waste

5.3.6 Breakage

Breakage is defined as any piece, meeting the minimum diameter of the TMS, which is shorter than 3 m in length and broken at the large end or broken at both ends.

If it resulted from "normal" falling or yarding, it is unavoidable and *not tallied*.

If it is excessive (or careless) it is considered avoidable and *is tallied* as such. In this case, it will be included in the cut-control volume.

This definition is not consistent with the inventory definition of breakage nor is it intended to be.

Undercut butts less than 3 m in length with a broken top are classified as breakage and should not be tallied.

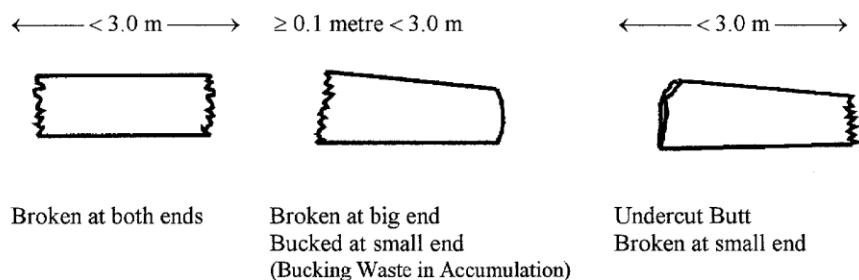

Figure 5-8 Examples of Breakage

5.3.6.1 Recording Breakage

Normal breakage is not usually recorded.

If a licensee wishes to measure breakage for its own purposes, it should all be tallied as *unavoidable* breakage which is not included in the cut-control volumes.

However, where breakage is considered excessive because of an inadequate harvesting method or was intentionally caused by the logging crew, it should all be recorded as *avoidable* waste. These volumes will be included in the cut-control volume.

In addition, breakage must be measured and charged to cut control where the inventory for the TSA or TFL has not been netted down for breakage. Breakage is recorded as "B" under "Kind of Material" on the FS 161 (Plot Survey Card).

A log lying in a dispersed area that is heavily fractured and common sense indicates that it would likely break into chunks below the TMS specifications in handling between "stump to dump", should be classified as breakage and not recorded.

5.3.7 Forks

A fork is defined to be a division of a log into two or more stems. Forks which measure greater than 3 m are measured as logs. If the diameters of forks are greater than or equal to the minimum diameter of the timber merchantability specifications, the portion(s) of the tree, above the fork or crook must meet the criteria for minimum log length to be considered avoidable waste.

If the portion(s) of the tree, above the fork or crook, doesn't meet the minimum log length criteria (3 m), it is considered unavoidable waste and must be recorded for cut control purposes.

In Figure 5.9, segment A, if visually extended to the minimum top diameter (5R), would meet the minimum log length (3 m); therefore, is classified as avoidable waste.

However, segment B, if visually extended to the minimum top diameter (5R), would not meet the minimum log length (3 m) and therefore is classified as unavoidable waste.

Segment C is recorded as unavoidable waste for safety reasons because lumber cannot be cut from it. The maximum length of segment C is 0.3 m unless the butt end of segment D shows two separate piths and then segments C and D are recorded as one unavoidable segment.

Segment D (with one pith showing) is recorded as avoidable waste.

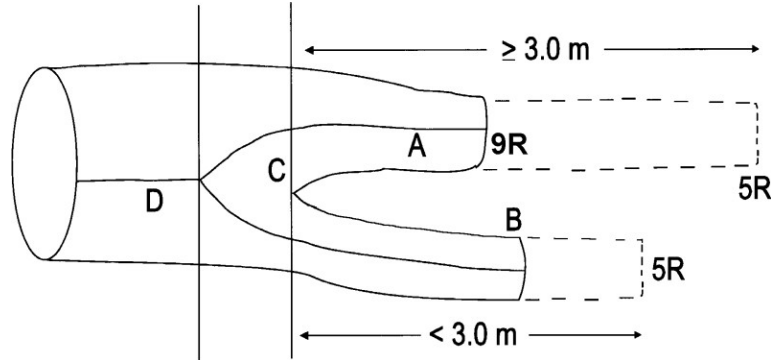

Figure 5-9 Forked Log

Segments A, B, C and D are recorded as separate pieces on the FS 161, each with its own piece number. Use FK as comment code to indicate the pieces belong to a fork.

5.3.8 Long Butts

For long butts under 3 m in length, pieces that are less than 50 percent sound are not required to be recorded; pieces that are more than 50 percent sound, the entire piece (net volume) is classified and graded as avoidable sawlog waste. In the Interior, if the long butt originated from a dead tree, it may be classified as avoidable grade 3 waste.

If there is clear evidence that bucking was done to raise the grade of the parent log from lumber reject to sawlog, then the long butt may be graded lumber reject. Log butts may be downgraded for forks, crooks, excessive twist, or oversized knots.

For long butts over 3 m in length, the piece is measured and graded as a log.

5.3.9 Coarse Woody Debris

Log pieces that may be required to meet coarse woody debris requirements are included in the waste benchmarks. No special provisions are made for coarse woody debris in waste assessments.

5.3.10 Special Cases

Waste surveyors often encounter pieces, usually less than the minimum log length, that are hard to classify as waste or breakage, or as avoidable or unavoidable. A few of these circumstances are listed here:

- a. embedded rock, usually resulting from blasting. If the pieces are trimmed within 20 cm of the rock, such pieces may be classified as unavoidable. If the pieces have been trimmed longer, the segment beyond the rock should be classified as avoidable, without making any trim allowance,
- b. chunks on the tail-spar or skidding trails used to support the roadbeds, that resulted in the breakage of pieces greater than the minimum log length. Such pieces are classified as avoidable, and may be graded according to the characteristics of the whole piece,
- c. windfalls will be tallied in the usual manner for in-plot portions. The exceptions are windfalls that are blown down after harvesting with their roots sitting outside the block. These pieces will not be tallied,
- d. helicopter bucking waste. Incorrect estimation of log weights may result in having to buck the logs shorter after attempting to lift them. Such waste is always regarded as avoidable,
- e. chunks in the landing, bucked at both ends and used to support a steel tower. Classify as avoidable waste and grade as per the parent log,
- f. avoidable breakage is recorded,
- g. unavoidable breakage is *not* recorded, or
- h. unavoidable bucking waste is recorded.

5.4 Field Standards

Those responsible for waste assessments must ensure that proper field procedures are followed, including the use of industry standard equipment, materials and conventions. Assessments which are not carried out properly will be rejected by the District Manager.

5.4.1 Maps

The block survey map should be at a scale of 1:5000 showing the cut-block boundaries, roads, landings, strata and other features required to correctly determine the area logged. If acceptable to the District Manager, another large scale may be used. In addition, the plot locations, base lines and points of commencement must be marked.

The style and map notation must be consistent with good forestry practice. Map symbols should be explained if they are not obvious. The cartographic standards used by the Ministry of Forests, Lands, Natural Resource Operations and Rural Development are mandatory.

5.4.2 Field Equipment and Supplies

The waste survey crew should use equipment that can perform the work within the allowable error limits. The minimum recommended equipment is:

- a. hand compass, with declination adjustment,
- b. clinometer with percent scale,
- c. topefil strings, 50 m metal or braided nylon chain, graduated in metres,
- d. logger's tape,
- e. BC metric scale stick,
- f. axe; tree marking paint, and
- g. tally book with waterproof tally cards, flagging ribbons, aluminum tags and felt markers.

The tie-points, plot centres, plot boundaries, and measured pieces must be clearly marked in the field. Tie points and plot centres must be marked with a solid stake well-driven into the ground, taped or painted, and numbered on aluminum tags, or with permanent felt marker. Orange paint is recommended for stakes. Plot boundaries and pieces must be clearly marked. The accuracy of boundary marking is only critical when measured pieces cross the boundary. Blue paint is recommended for boundaries and pieces. Paint must be log or tree-marking grade.

5.4.3 Traverse Notes

When a field assessment involves traversing areas, proper notes must be kept to support the area compilations. These notes will show:

- a. the forward sighting of the bearings,
- b. the slope in degrees or percent,
- c. slope distances in metres,
- d. horizontal distances in metres, and
- e. retain traverse notes with all other working papers for inspection by Forest Service check-survey or audit staff.

Any typing within subpopulations must be supported by field notes and may not be done on a plot-by-plot basis.

Plot Tallies

Plot tally cards must contain at least the information prescribed in this manual, and be in the prescribed format. They must be printed on moisture-resistant and durable field material.

5.5 Measurement Protocol and Standards

5.5.1 Lengths

Lengths will be recorded to the nearest tenth (0.1) of a metre:

for exact 0.05 m lengths round to the lower tenth (0.1) of a metre.

Example:

A log 4.25 m in length - record as 4.2 m

A log 4.26 m in length - record as 4.3 m

The determination of KIND (logs, bucking waste, breakage) is made on the basis of gross length.

5.5.1.1 Broken Tops

The length measurement procedures for broken tops are (refer to Figure 5.10):

- Step 1 Locate the TMS top diameter (must have minimum slab thickness of 5R) measured from the small end.
- Step 2 Measure gross length which commences from the top diameter.
- Step 3 Locate the X Y line upon which the volume above the top diameter to the X Y line (Section B) equals to the void of the missing wood (Section A).
- Step 4 Record a length deduction which is measured from the top diameter to the X Y line.

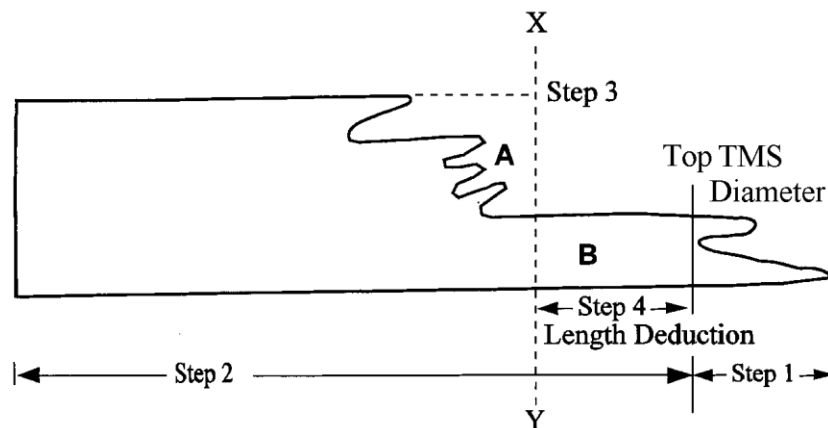

Figure 5-10 Measuring Broken Tops

Logs broken at both ends are tallied only if they meet or exceed 3 m, midpoint to midpoint. Logs of less than 3 m are breakage and not tallied.

Example:

A log 2.99 m in length - is breakage - do not tally

A log 3 m in length - is a log - tally as 3 m

A log 3.06 m in length - tally as 3.1 m

5.5.1.2 Shattered Ends

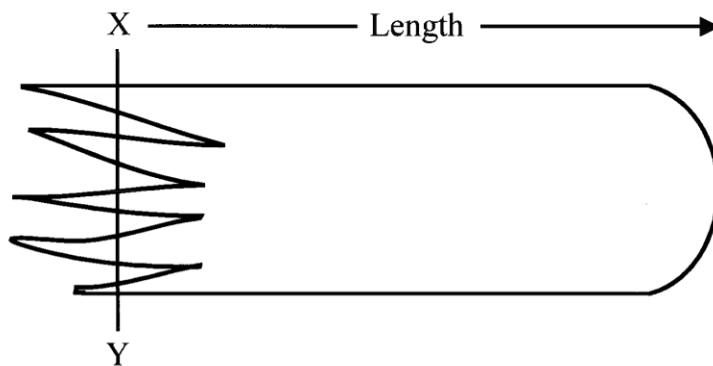

Figure 5-11 Measuring Shattered Ends

Length is measured to the XY line where the protrusions are folded in to compensate the missing wood in the voids.

5.5.1.3 Stump Heights

Minimum stump height must be 36 cm above high side to be tallied: rounding to nearest 10th of a metre gives 0.4, less 0.3 m stump allowance, nets 0.1 m to be tallied.

Examples of Stump Heights:

Stump height 0.35 m - do not tally

Stump height 0.36 m - tally and record as 0.1 m

Stump height 0.36 m - tally and record as 0.1 m

Stump height 0.45 m - tally and record as 0.1 m

Stump height 0.46 m - tally and record as 0.2 m

5.5.2 Diameters

Diameters will be recorded to the nearest radius class unit (rad), inside bark.

If the end is out of round, the average of measurements taken across two or more representative diameters shall be recorded as the end measurement.

All half measurements shall be taken to the nearest even number. Thus 24.5 will be recorded as 24 while 25.5 will be recorded as 26.

Top log diameter standards reflect log diameters in centimetres, which must be converted to radius class units for field measurement.

Example:

15 cm =	7.5 rads - represented on the scale stick by the black line between 7 and 8 rads.
10 cm =	5 rads - represented on the scale stick by the red line in the middle of the 5 rad class.

5.5.2.1 Stump Diameters

In the Interior, a minimum diameter at stump height (outside bark) is specified in the timber merchantability specification and this dsh is measured at a point 0.3 m above the high side of the stump. The minimum dsh must be obtained without rounding up or the stump is grade 6 and doesn't have to be tallied.

All tallied stumps have their top diameters measured and recorded inside bark so it is possible to have a stump diameter which is less than the minimum dsh.

If the stump total height, which includes the TMS of 30 cm, is less than 1.3 m, measure the top diameter on the top of the stump. If the stump total height exceeds 1.3 m, measure the top diameter at 1.3 m above the ground on the high side.

On the Coast, where no minimum dsh is specified, a stump will only be considered if a log equal to or exceeding the timber merchantability specifications was deemed to have been cut from it.

Where no minimum dsh is specified, the minimum dbh above high-side in the cruise will apply as the minimum dsh (inside bark). That is, 12.0 cm dbh (outside bark, immature on the Coast) will be a 6.0 rad dsh; a 17.5 cm dbh (mature on the Coast) will be rounded up to 9.0 rads dsh.

5.5.3 Bucking Waste

Cut at both ends - tally to the nearest tenth (0.1) of a metre regardless of length.

Cut at large end - tally as waste if length meets or exceeds a tenth (0.1) of a metre.

Example:

0.09 m in length - do not tally,

0.10 m in length - tally as a tenth (0.1) of a metre.

5.5.4 Deductions

Deductions for defect should be calculated in the field using the British Columbia metric scale stick.

The compilation program will subtract numbers (if any) in the deduction columns for length, top and/or butt from gross length, top and/or butt dimensions respectively. The resulting dimensions will then be used to calculate volume.

The numbers that are tallied in the deduction columns are not actual dimensions but length or radius deductions, i.e., a log with gross dimensions of 4.2 m and 18 rad top / 20 rad butt with 0.6 m, 2 rad top and 5 rad butt deductions would be calculated as a 3.6 m, 16 rad top / 15 rad butt log.

5.6 Data Status and Recording Format

As an aid to the waste surveyor, throughout this guide the items (or fields) of information or data to be recorded on the two field cards have been grouped into 5 status categories and coded as follows:

R	Indicates fields of critical data that REQUIRED for the compilation program and therefore must always be correct and complete. (Field must never be left blank).
~S~	Indicates fields of data that are required only occasionally (i.e., when the item being identified is SUPPLEMENTAL or quantified is actually present, decay for example). (Field may be left blank when no data is required.)
U	Indicates data that is USEFUL for the waste surveyor to make correct field decisions. This data should be recorded in the office before proceeding to the field to establish plots (field may be left blank).
O	Indicates OPTIONAL data that need not be recorded. If it is decided not to record this data, it must be left blank consistently within a cut block.

Abbreviations used to identify the correct recording format for each character within a field are as follows:

n	-	Numeric characters only.
a	-	Alpha characters only.
An	-	Any combination of alpha and/or numeric characters.
Rj	-	Right justified.
Lj	-	Left justified.
Nba	-	No blank characters allowed in the whole field.
Bp	-	Blanks are permitted within the field.
n.n	-	Left number quantifies total numeric characters in the field, right number quantifies the number of numeric characters to the right of an unseen decimal.

5.7 Completing the FS 444 (Block Summary Card)

One FS 444 must be completed for each block sampled regardless of which sampling option has been chosen and the number of plots to be established in it.

This section may be further revised when the new Waste System is in full implementation.

5.7.1 Header

<i>F.D. - FOREST DISTRICT</i> <i>*R* (2n-nba)</i>	Identifies the Ministry of Forest, Lands and Natural Resource Operations District Office responsible for the administration of the block being sampled. ◀▶
--	--

Administrative Area	Region	District	Acronym
Coast Area	South Coast	Chilliwack	DCK
		Sea to Sky	DSQ
		Sunshine Coast	DSC
	West Coast	Campbell River	DCR
		Haida Gwaii	DQC
		North Island	DNI
		South Coast	DSI
North Area	North East	Peace	DPC
		Fort Nelson	DFN
	Omineca	Mackenzie	DMK
		Prince George	DPG
		Stuart Nechako	DJA
	Skeena	Coast Mountains	DKM
		Nadina	DND
Skeena/Stikine		DSS	
South Area	Cariboo	100 Mile House	DMH
		Cariboo-Chilcotin	DCC
		Quesnel	DQU
	Kootenay/Boundary	Rocky Mountain	DRM
		Selkirk	DSE
	Thompson Okanagan	Cascades	DCS
		Okanagan Shuswap	DOS
Thompson Rivers		DKA	

<p><i>REP. YR. - REPORTING YEAR *R* (2n-nba)</i></p>	<p>Identifies the last two digits of the year in which the sampling for the block was completed.</p>			
<p><i>REPORTING UNIT *R* (5n-rj)</i></p>	<p>Identifies the area for which the weighted sampling error objectives must be met.</p> <p>If the block sampling option is being used, each block is a Reporting Unit (RU) and will be given a unique RU number.</p> <p>If an aggregate sampling option is being used, each aggregate (group of blocks) is an RU and will be given a unique RU number.</p> <p>Reporting Unit numbers will be created by the online Waste System.</p>			
<p><i>YEARS LOGGED *R* (2 of 2n-nba)</i></p>	<p>Identifies the last two digits of the year primary logging started on the cut block and the last two digits of the year primary logging was completed. If the logging was done in one year, use the same two digits in both fields. District Managers may require blocks that are to be harvested over more than 2 seasons be split for administrative reasons. Therefore, portions of blocks logged in one year must be surveyed no later than the following year.</p>			
<p><i>TIMBER MARK *R* (6an-lj)</i></p>	<p>Identifies the timber mark used for the block.</p> <p>If more than one timber mark was used for the block then a separate FS 444 must be completely filled out for each mark, specifying all the information for that area (net area, stratum, stratum areas and plot sizes, utilization standards etc.). A separate FS 72 will be printed for each block/mark combination.</p> <p>For wavy lines, record ":", for bars, record "-", for crescents records "" and for old "X" timber sales, record "<". Some examples are as follows:</p>			
	TFL 22, CP 7	22/7	FL A01369, CP 9	F76009
	TL within TFL	HZ0021	TSL A48416 -	48416

<p><i>LICENCE *R*</i> (6an-lj)</p>	<p>Identifies the licence number of the block being sampled. Some examples are as follows:</p>			
	TFL 1	TFL001	FL A17645 -	A17645
	LOT 217	LOT 217	Wood Lot 443	W0443
<p><i>CP - CUTTING PERMIT *R*</i> (4an-rj)</p>	<p>Identifies the cutting permit number under which harvesting of the block was authorized.</p>			
<p><i>BLOCK - CUT BLOCK *R*</i> (4an-rj)</p>	<p>Identifies the actual cut block or opening being sampled. The cut block numbers recorded on the FS 444 should correspond to the cut block numbers listed in the annual plan.</p>			
<p><i>PLC DATE *R*</i> (3 of 2n-rj)</p>	<p>Identifies the last two digits of the year, the month and the day on which primary logging was completed for the cutblock.</p>			
<p><i>SURVEY DATE *R*</i> (3 of 2n-rj)</p>	<p>Identifies the last two digits of the year, the month and the day in which the last plot was established in the block.</p>			
<p><i>NET AREA *R*</i> (4.2n rj)</p>	<p>Quantifies, in hectares, the total area of all stratum areas available for sampling and/or estimating.</p> <p>This area includes any accumulation areas not within a cut-block such as in helicopter logging or when logs are skidded off a cut-block to a nearby central landing area. Landings will include only the area of the actual waste piles.</p>			
<p><i>ROADS NP.NF *R*</i> (4.2n-rj)</p>	<p>Quantifies, in hectares, the total area of road surface, non-productive and non-forest land.</p> <p>Road surface can be calculated by measuring the total length from the map (so long as it is sufficiently accurate) and multiplying by an average width for the road (usually 8.0 m).</p> <p>Do not include the ditch in the road surface area calculation as it is part of the population being sampled.</p>			

	Do not include skid roads, cat roads, or back spar trails etc. as they are part of the dispersed type stratum. NP and NF areas to be included are only those that have been typed out on the operational cruise used for the stumpage appraisal.
<i>Waste Benchmark "R"</i> (4n-rj)	Quantifies, in cubic metres per hectare of avoidable waste threshold. Refer to Appendix 5.
<i>CRUISE VOLUME per ha</i> <i>*R*</i> (4n-rj)	Quantifies, in cubic metres per hectare, the average cruise volume for the block. Data available from cruise summaries. Estimate if data is unavailable.
<i>REAS. - REASON FOR SURVEY *R*</i> (1a) (RWS 2.70 only)	Identifies the purpose of the sampling. This allows the FS 444's and the FS 161's to be used for more than one type of waste measurements on the same block without the data becoming mixed up in the computer files. See the back of the FS 444 for codes.
<i>SNOW Y/N *R*</i> (1a) (RWS 2 - 70 only)	Identifies the presence of snow at the time of logging. See the back of the FS 444 for codes.
<i>SNOW MAX STUMP HT.M</i> <i>*R*</i> (RWS 2 - 70 only)	Quantifies, in metres, a maximum stump height which is different than the TMS (0.3 m). This occurs almost exclusively in the interior when, under certain circumstances, logging can only proceed during the winter. In any case, approval to leave stumps over 0.3 m due to snow (and therefore classify them unavoidable on FS 161) must be in writing from the FLNROD District Manager.

5.7.2 Area Statement

<p><i>TYPE STRATUM *R*</i> (aana-nba)</p>	<p>Type stratum is a term that describes any and all subdivisions of a sub-population within a block made for sampling purposes.</p>
---	--

Each type stratum is comprised of a four-character code.

5.7.2.1 Dispersed and Accumulated Types

The FIRST character, (alpha) starting from the left, identifies the waste type.

The recognized waste types and their codes are as follows:

Waste Types	Code														
1.	<table border="1"> <tr> <td colspan="2" data-bbox="446 821 1133 877">Dispersed Types</td> </tr> <tr> <td data-bbox="446 877 917 934">Dispersed Retention</td> <td data-bbox="917 877 1133 934">D</td> </tr> <tr> <td data-bbox="446 934 917 991">Felled and bucked</td> <td data-bbox="917 934 1133 991">F</td> </tr> <tr> <td data-bbox="446 991 917 1047">Group Retention</td> <td data-bbox="917 991 1133 1047">G</td> </tr> <tr> <td data-bbox="446 1047 917 1104">Historic Waste</td> <td data-bbox="917 1047 1133 1104">H</td> </tr> <tr> <td data-bbox="446 1104 917 1161">Open Slash/Clearcut</td> <td data-bbox="917 1104 1133 1161">S</td> </tr> <tr> <td data-bbox="446 1161 917 1220">Standing Stem</td> <td data-bbox="917 1161 1133 1220">T</td> </tr> </table>	Dispersed Types		Dispersed Retention	D	Felled and bucked	F	Group Retention	G	Historic Waste	H	Open Slash/Clearcut	S	Standing Stem	T
Dispersed Types															
Dispersed Retention	D														
Felled and bucked	F														
Group Retention	G														
Historic Waste	H														
Open Slash/Clearcut	S														
Standing Stem	T														
2.	<table border="1"> <tr> <td colspan="2" data-bbox="446 1220 1133 1285">Accumulated Types</td> </tr> <tr> <td data-bbox="446 1285 917 1341">Landings</td> <td data-bbox="917 1285 1133 1341">L</td> </tr> <tr> <td data-bbox="446 1341 917 1398">Roadside</td> <td data-bbox="917 1341 1133 1398">R</td> </tr> <tr> <td data-bbox="446 1398 917 1455">Windrow, Debuilt road</td> <td data-bbox="917 1398 1133 1455">W</td> </tr> <tr> <td data-bbox="446 1455 917 1512">Cold decked</td> <td data-bbox="917 1455 1133 1512">C</td> </tr> <tr> <td data-bbox="446 1512 917 1568">Spot accumulation</td> <td data-bbox="917 1512 1133 1568">P</td> </tr> <tr> <td data-bbox="446 1568 917 1688">Off-site landing (i.e. not in the block)</td> <td data-bbox="917 1568 1133 1688">O</td> </tr> </table>	Accumulated Types		Landings	L	Roadside	R	Windrow, Debuilt road	W	Cold decked	C	Spot accumulation	P	Off-site landing (i.e. not in the block)	O
Accumulated Types															
Landings	L														
Roadside	R														
Windrow, Debuilt road	W														
Cold decked	C														
Spot accumulation	P														
Off-site landing (i.e. not in the block)	O														

The "O" for off-site landings is required to identify those landings where the area of the landing is needed to calculate volume and this area *should* be included in the block net area.

The SECOND character (alpha) identifies the method used to harvest the waste type being sampled. This is a descriptive label only and will not cause a separate stratum to be created. Harvesting method codes are shown as follows:

Harvesting Method	Code
Spar (high lead)	S
Grapple yarder	G
Tractor (cat)	T
Horse	P
Rubber-tired skidder	R
Hand logging	M
Hoe chucking	B
Helicopter	H
Wyssen	W
Other	O

Open slash that has been logged using more than one harvesting method can be given the code for the predominant method or the code for a combination of methods.

The THIRD character identifies the assessment method used.

There are four assessment methods, and their codes are:

•Ocular Estimate	O
•Estimate Percent	E
•100% Measure	S
•Plot	P

When a method other than plot is used, use the "alpha" method code.

When the plot method is used, select the "Numeric" code that corresponds with the plot size in the table below. There must be at least two plots in each stratum.

0 - 50 m ²	5 - 500 m ²
1 - 100 m ²	6 - 600 m ²
2 - 200 m ²	7 - 1 000 m ²
3 - 300 m ²	8 - 5 000 m ²
4 - 400 m ²	9 - 10 000 m ²

The FOURTH character (alphanumeric) identifies any *stratification* of waste types into waste levels.

When significantly different levels of waste occur within a waste type and they can be easily identified and mapped, the waste surveyor must stratify them into waste levels.

The codes: "L", "M" and "H" for "light, medium and heavy" respectively or one to nine (1 to 9) may be used.

If no stratification is done, or for 100 percent piece scales, record "X".

Stratification, if done carefully, can reduce the coefficient of variation and therefore also reduce the sampling error.

Stratification of accumulation waste types, when significantly different waste levels exist, can help accomplish this in either sampling option.

Stratification of dispersed waste types could also be beneficial in the cut block sampling option. It will, however, be of limited use in the aggregate sampling option due to the generally small number of plots involved.

Where the plot method is used, each stratum created in either the accumulation or dispersed sub-population requires a minimum of two plots.

If sampling error is reduced with good stratification in the field, it is possible to reduce the number of plots required for the next sampling year.

Caution must be used, however, because poor stratification will cause the sampling error to increase and therefore unnecessary extra field work will result.

Any stratification of waste types must be supported with field notes and a map.

An accurate area calculation is required for each stratum and all of the plots attributed to a stratum must fall within its boundaries (i.e., stratification cannot be done on a plot by plot basis).

5.7.2.2 Standing Trees

Depending on the assessment method used, the stratum codes are:

<i>STRS</i>	Where trees are measured individually using the one hundred percent measure method.
<i>STRE</i>	Where tree volumes in a patch is estimated using the estimate percent method.

<i>DISPERSED AREA *R*</i> (4.1 n-rj)	Each line on the area statement quantifies, in hectares, the area of a dispersed waste type or waste level.
<i>ACCUMULATIONS - 100% *R*</i> (5.2n-rj)	<p>Each line on the area statement quantifies, in hectares, the area that has been 100% measured or estimated (i.e., not sampled with plots).</p> <p>Normally only single and/or very small landings, cold decks, small concentrated spot accumulations, unsafe piles or small patches of felled and bucked timber would be measured in this manner.</p> <p>If this measurement option is chosen for a stratum or substratum, all of the area in the stratum or substratum must be either 100 percent measured or estimated.</p> <p>"S" Not Used - Leave Blank. This is the column between "100 percent" and "Fixed".</p>

<p>FIXED *R* (5.2n-rj)</p>	<p>Each line on the area statement quantifies, in hectares, the area of any accumulated types or waste levels (i.e. type stratum) that have been sampled with plots of a fixed radius (a 400 m² plot = 11.28 m radius).</p> <p>3P Not used - leave blank.</p>
<p>PLOT SZ m² - PLOTSIZE *R* (3n-rj)</p>	<p>Each line quantifies, in square metres, the plot size used for the various type stratum.</p> <p>The normal plot size for dispersed types is 400 m² (circular with radius of 11.28 m). Smaller plot sizes are allowed for partial cutting.</p> <p>Accumulated types can be sampled with a 50 m² plot (circular with radius of 3.99 m), or rectangular or square plots of 100, 200, or 400 m².</p> $\sqrt{\text{plot size (m}^2\text{)} / \pi}$ <p>The plot radius formula is (<i>plot size (m²) / π</i>).</p>



All plots within a type stratum must be the same size.

<p>GRID DIST.m - GRID DISTANCE *R* (3n-rj)</p>	<p>Quantifies, in metres, the horizontal distance between plots on a strip and between strips on a baseline for dispersed types.</p> <p>It can also be used to quantify the horizontal distance between plots along the roadside accumulations.</p>
<p>SECOND OLD GR - SECOND or OLD GROWTH *U* (1a)</p>	<p>Identifies the predominant age class of the timber that was in the cut block.</p> <p>Codes are "O" for old growth (121 years and older) and "S" for second growth (under 121 years).</p>
<p>GRADES *U* (1a)</p>	<p>Identifies whether Coast or Interior grades are applicable for the block. I = Interior and C = Coast.</p>

5.7.3 Timber Merchantability Specifications

These specifications are described in this manual.

<p><i>SPECIES *R*</i> (2a-bp)</p>	<p>Identifies the species.</p> <p>Where the species is blanked out on the first line, the blank refers to all species).</p>
<p><i>MSH cm - MAXIMUM STUMP HEIGHT *R*</i> (2n-rj)</p>	<p>Quantifies, in centimetres, the TMS stump height allowed of 30 cm.</p>
<p><i>TOP cm *R*</i> (2n-rj)</p>	<p>Quantifies, in centimetres, the minimum top diameter, inside bark.</p> <p>On the coast it is always 15 cm for old growth timber and 10 cm for second growth.</p> <p>In the Interior, for red cedar 140 years or older, the top diameter is 15 cm; for younger red cedar and all other coniferous species it is 10 cm.</p>
<p><i>MLL m - MINIMUM LOG LENGTH *R*</i> (2.1n-rj)</p>	<p>Quantifies, in metres, the minimum log length that must be recovered.</p> <p>Currently it is 3 m for both the Coast and the Interior.</p>
<p><i>AGE *R*</i> (3n-rj)</p>	<p>Identifies the age of any species. Applies to the Interior only, leave blank on the Coast.</p>

Province of
British Columbia
Ministry
of Forests

**RESIDUE SURVEY
BLOCK SUMMARY**

F.D.	REP. YR.	REPORTING UNIT	YEARS LOGGED	TIMBER MARK	LICENCE	C.P.	BLOCK	SNO	MAX ST.			
			to									
PLC DATE			SURVEY DATE			NET AREA	ROADS/	W.BENCHMARK	CRUISE	REAS	Y/N	HT.
Y M D			Y M D			(AREA STATE)	NP / NF	m ² /ha	VOL./ha			m

AREA STATEMENT												
TYPE STRATUM	DISPERSED AREA	ACCUMULATIONS							SUB POP	PLOT SZ m ²	GRID DIST. m	SECOND OLD GR
		100%	S	FIXED	3P							
TOTALS												

MINIMUM UTILIZATION				
SPE- CIES	MSH cm	TOP cm	MLL m	AGE
TOTALS				

NET AREA

POC/TP	NOTES

Please be advised that this information may be released under the *Freedom of Information and Protection of Privacy Act*.

FS444 HVA 2001/04

Figure 5-12 Front of FS444 (Block Summary Card)

COMMENTS <hr/> <hr/> <hr/> <hr/> <hr/> <hr/> <hr/> <hr/>	
PREPARED BY	SIGNATURE

Coding for Block/Plot Headers

REASON FOR SURVEY: B - billing, C - check, S - special purpose
 SNO: Y/N - Snow Pack: Y - yes (when logged), N - none
 Max. Stump Height: m (DM prior approval letter)

SECOND/OLD GROWTH: S - second, O - old
 GRADES: I - Interior, C - Coast
 PLOT TYPE: A - accumulation
 D - dispersed
 PLOT SHAPE: C - circular, S - square, R - rectangular;
 3 - 3P, X - 100% scale
 MEASURED %: blank - dispersed plots; for accumulations, 05-95 (5% to 95%),
 00 - 100%

Coding for Plot Tallies

SEGMENTS: use different piece numbers
 SPECIES: use the scaling codes: FI, CE, HE, BA, SP, CY, LO, WH, WB,
 YE, LA, AL, AS, BI, CO, MA, OT
 KIND OF MATERIAL: L - log, slab, sliver, chunk, S - stump,
 D - down tree/snag, U - undersize,
 T - tree/snag, B - breakage (< min. log length),
 W - bucking and trimming waste, X - special product (shake bl.)
 CLASS: A - avoidable, U - unavoidable
 END CODE: B - broken, C - cut (bucked), N - natural (min. cutting specs. - pencil
 bucked), U - felling undercut (butt)
 DECAY TYPE: blank - none, H - heart rot (through), T - top rot, B - butt rot,
 R - ring rot, C - conk rot, P - pocket rot, S - sap rot
 GRADE Coast - U, X, Y, 5 (dry Y); Interior - blank (sawlog), 3, 4, 5, 6
 BORDERLINE CODE: blank - completely inside plot, B - borderline piece, X - length
 exceeds plot width

CODED COMMENTS:

BK - bunch knots and burls	LB - long butt
BR - buried	MP - multiple pieces
CA - candelabra	SA - sapling
CL - culvert log	SB - shake block
CR - severe crook or pistol grip	SL - slab
DP - "dead potential" (inv. classif.)	US - unsafe
DU - "dead useless" (inv. classif.)	WD - woody debris
FK - fork	WF - windfall
FL - fluted butt	WS - windshear

Figure 5-13 Back of FS 444 (Block Summary Card)

5.8 Completion of the FS 161 (Plot Tally Card)

5.8.1 Header

At least one FS 161 must be completed for each plot established.

If a plot has no pieces, record "*Nil Plot*" across the card.

If more than one page is required, record the page number on all pages.

Fill out the header line on all individual plot cards so that if the cards become separated they can be identified and reunited.

<i>LICENCE *R*</i> (6an-lj)	See "LICENCE" on FS 444. Must be identical to the licence number recorded on the FS 444.
<i>C.P. - CUTTING PERMIT *R*</i> (3an-rj)	See "CUTTING PERMIT" on the FS 444. Must be identical to the cutting permit recorded on the FS 444.
<i>BLOCK - CUT BLOCK *R*</i> (4an-rj)	See "BLOCK" on the FS 444. Must be identical to the block number recorded on the FS 444.
<i>DATE *R*</i> (3 of 2n-rj)	Identifies the year (last two digits), month and day when the plot was established.
<i>CERT - CERTIFICATE NUMBER *R*</i> (4an-rj)	Identifies the certificate number of the waste surveyor responsible for the establishment of the plot. Those without a waste licence number may use the following: Coast Forest Region = WACO Southern Forest Region = WASI Northern Forest Region = WANI Individuals conducting plot surveys who are not licenced waste surveyors must include the name and registration number of the sponsoring forestry professional in the comment field of the system/report.

<p>RET # - RETURN NUMBER *R* (3n-rj)</p>	<p>Identifies the return number of the waste surveyor responsible for the establishment of the plot.</p> <p>Return numbers will increment by one for each new block sampled in a given year.</p>
---	--

It is the responsibility of each certified waste surveyor to keep track of his/her own return number. These numbers automatically revert to "001" on January 1st of each year.

<p>B.LINE - BASELINE *R* (1a)</p>	<p>Identifies the baseline the plot is tied to.</p> <p>Use codes "A" "B" "C" etc.</p>
<p>STRIP *R* (2n-rj)</p>	<p>Identifies the strip number that plots are located on.</p>
<p>PLOT NO. *R* (2nrj)</p>	<p>Identifies the plot number. The strip/plot number combination must be unique within a type stratum.</p>
<p>TY. - PLOT TYPE *R* (1a) (used only in RWS 2.70 program only)</p>	<p>Use this field to identify the subpopulation type for the plot as recorded on the FS 444. Use codes, "D" for dispersed, "A" for accumulation, "E" for estimate or "M" for 100 percent scale.</p>
<p>PLOT SH - PLOT SHAPE *R* (1a-bp) (RWS 2.70 only)</p>	<p>Identifies the plot shape. Use codes "C" = Circular, "R" = Rectangular, "S" = Square. Must be blank for estimated plots and 100 percent measure plots.</p>
<p>MEAS.% - MEASURE % *R* (2n-rj)</p>	<p>Quantifies the percentage of the volume, within the plot boundaries that has been measured and recorded.</p> <p>A reasonable effort must be made to measure as much as possible even if one end of the piece cannot be seen and must be estimated.</p> <p>See the codes on the back of the FS 444.</p> <p>For RWS 2.70, use code 00 for 100 percent. For the new waste system, measure percent is always defaulted to 100.</p>

<p><i>TYPE STRATUM *R*</i> (aana-nba)</p>	<p>See "TYPE STRATUM" on the FS 444.</p> <p>Must be identical to the type stratum code (listed on the FS 444) for the type stratum in which the plot falls.</p>
---	---

5.8.2 Piece Descriptions

<p><i>PIECE NO. *R*</i> (3n-rj)</p>	<p>Identifies the piece. Increment by one for each new piece. For pieces that are segmented for classification purposes (i.e., a stump with one avoidable segment and one unavoidable segment), use a different piece number for each segment and record MP on the comment column to indicate multiple pieces.</p>			
<p><i>BOR.LINE – BORDERLINE *S*</i> (1a)</p>	<p>Identifies pieces that lay across the plot boundary.</p> <p>Also identifies pieces having a length that exceeds the diameter of the plot because the plot is on a steep slope or because the piece is standing on end (tree or piece standing in a pile).</p>			
	I	= Piece completely inside plot.		
	B	= Borderline piece (measure inside portion only).		
	X	= Pieces that exceed the plot diameter.		
<p><i>SPECIES *R*</i> (2a-bp)</p>	<p>Identifies the species of the piece. Acceptable codes are as follows:</p>			
	DOUGLAS FIR	- FI	WHITEBA R K PINE	- WB
	RED CEDAR	- CE	CYPRESS	- CY
	WHITE PINE	- WH	BIRCH	- BI
	YELLOW PINE	- YE	LARCH	- LA
	ASPEN	- AS	BALSAM	- BA
	COTTONWOOD	- CO	SPRUCE	- SP

	LOGEPOLE PINE	- LO	ALDER	- AL
	HEMLOCK	- HE	MAPLE	- MA
<i>KIND *R*</i> (1a)	Identifies the nature or shape of the piece. See the back of the FS 444 for the codes.			

Logs (L)

Includes all logs and slabs which are at least 3 m in length.

Down Trees (D)

Includes all down trees exceeding the timber merchantability specification.

Standing Trees (T)

Includes all standing trees exceeding the timber merchantability specifications.

Stumps (S)

Includes all stumps greater than 0.3 m and less than 3.3 m in total height measured from the high side to the top of the felling cut.

Only record that portion of each stump that is above the stump height (0.3 m) measured from the ground on the high side of the stump.

Stumps over 3.3 m in length should be measured from the contractual stump height (0.3 m) and classified as logs.

Dead stumps normally are not required to be tallied. The exception is catastrophic grade 3 stumps.

Bucking Waste (W)

Includes all portions of logs and slabs and less than 3 m in length and cut on at least one end in accumulations and cut at the larger or both ends in dispersed waste types.

Special Products (X)

Includes already manufactured products less than 3 m in length such as shake bolts or fence posts that have been left on the block.

Breakage (B)

Includes all pieces shorter than 3 m and broken at both ends. "Normal" breakage is not tallied.

If a licensee wishes to measure breakage for its own purposes, it should be tallied as *unavoidable* and will not be included in the cut-control volume.

However, where breakage is considered excessive because of an inadequate harvesting method or was intentionally caused by the logging crew it should be tallied as *avoidable* breakage and billed monetarily and against the licensee's cut-control according to its grade.

Do not scale or record breakage unless specifically requested to do so or it is excessive & avoidable.

<p>WASTE - WASTE CLASS *R* (1a)</p>	<p>Identifies the waste class (avoidable/unavoidable) of the piece. This is based solely on the physical accessibility and/or safety concerns for recovery of each piece. Waste class has nothing to do with quality.</p> <p>See "Waste Class" in Section 5.1.3 for a detailed description of how to identify the waste class of a piece.</p>
--	---

5.8.3 Gross 'In Plot' Dimensions for Pieces

The piece dimensions are inclusive of decay (i.e., they are not reduced to account for the volume of decay).

They include only the portion of the piece within the plot boundaries.

Length is measured to the plot boundary and the diameter of that end is taken there.

<p>LENGTH *R* (3.1 n-rj)</p>	<p>Quantifies, in metres, the "in plot" length of the piece.</p>
<p>TOP *R* (3n-rj)</p>	<p>Quantifies, in rads, the gross diameter, inside bark, of the top end.</p>
<p>E - END DESCRIPTION *R* (1a)</p>	<p>Describes whether the top end is natural (N), cut (C), Broken (B) or buried (X).</p>
<p>BUTT *R* (3n-rj)</p>	<p>Quantifies, in rads, the gross diameter, inside bark, of the large end.</p>
<p>E - END DESCRIPTION *R* (1a)</p>	<p>Describes whether the butt end is undercut (U), cut (C), natural (N), Broken (B) or buried (X).</p>

<p>GRADE *R* (1a)</p>	<p>Identifies the grade of the piece regardless of the kind of wood or waste class.</p> <p>For a complete description of the log grades, Coast or Interior, refer to the <i>Scaling Manual</i>.</p> <p>Waste surveyors on the <i>Coast</i>, must correctly identify "J", "U", "X", "Y", "dry Y" and "Z" grades.</p> <p>Waste surveyors in the <i>Interior</i> must be able to correctly identify all interior grades (1, 2, 4, dry 4, 6 and Z).</p>
----------------------------------	---

Dry Y (Coast) or Dry 4 (Interior), (former grade 5, not measured in waste, and is defined as follows)

Summary of the Grade Rule (for all species)

Logs and slabs graded as lumber reject and cut from trees which were *dead when harvested*.

Log requirements for the grade:

To be classified as dry the log *must* have one or more of the following characteristics (INDICATORS):

- a. deteriorated cambium,
- b. loose or shedding bark,
- c. sap rot,
- d. wood borers,
- e. deep checks (not weather checks).

Logs *cannot* be classified as dry if they display any of the following characteristics (Contraindicators):

- a. curling bark (green bark that is curling or cupping due to the drying process),
- b. green needles,
- c. fresh cambium (sticky)
- d. mildew or mold on wood surface (except on windthrow),

- e. charred wood (recent fire kill),
- f. dark weathered ends (indicative of decked timber), or
- g. pitching log ends.

Logs which display at least one *Indicator* plus one or more *Contra-indicators* are deemed to have come from a live, green tree.

Where the logs display characteristics (e.g., sun checks) which were caused by delays between timber felling and survey, they do not qualify as dry 4 or Y.

5.8.4 Deduction for Rot or Holes

It is a standard scaling convention in British Columbia to account for the volume of decay by reducing the gross dimensions of a piece by a *length and/or diameter (rad) deduction* (computed using the volume data on the scale stick). This gives net dimensions that will produce a volume equal to the net volume of the piece. This process is well documented in the *Scaling Manual*.

For waste assessments the *length and/or diameter (rad) deductions* must be recorded along with the gross dimensions of the piece and the compilation program calculates the net volume of the piece.

This is different from Scaling where they only record the net dimensions of each piece.

Waste surveyors must be able to calculate these deductions accurately and then record them on the FS 161.

<i>LENG. - LENGTH *S*</i> (2.1n-rj)	Quantifies the length deduction in tenths of metres.
<i>TOP *S*</i> (2n-rj)	Quantifies, in rads, the diameter deduction for the top end.
<i>BUTT *S*</i> (2n - rj)	Quantifies, in rads, the diameter deduction for the butt end.
<i>D - DEFECT TYPE *S*</i> (1a)	Identifies the type of decay in the piece. Must be recorded whenever a deduction has been recorded. See the back of the FS 444 (Figure 5.13) for codes.

5.8.5 Outside Plot Measurements

Outside plot measurements are not required in the new Waste System.

Everything to the right of decay type on the Waste Survey Plot Tally Card is optional and does not have to be completed.

The comment codes are very useful for explaining the waste classification or grade assigned to the piece. This information is not subject to audit.



The "outside measurements" are essential if any studies of average piece size are contemplated (e.g., the outside butt diameter will help to substantiate the grade of the piece).

<i>FAR END *O*</i> (2n-rj)	Quantifies the diameter, in rads, of the actual end of the piece when it is outside the plot boundary. This diameter can be estimated.
<i>ADD LENGTH - ADDITIONAL LENGTH *O*</i> (3.1 n-rj)	Quantifies, in metres, the additional length of the piece that is outside the plot boundary. This length can be estimated.
<i>COMMENT CODE *O*</i> (2a)	Additional descriptive information that may be useful. See the back of the FS 444 for codes that the computer compilation program will accept.
<i>BLANK COLUMN</i> (unlabelled)	For your own use.
<i>PIECE VOLUME</i>	This column allows for recording piece and plot volumes.

A simple formula for computing volume with a pocket calculator is:

$$\text{VOLUME} = [(t * t) + (b * b)] * L * K$$

Where	V	=	volume in cubic metres
	t	=	top diameter in rads
	b	=	butt diameter in rads
	L	=	Length in metres
	K	=	0.000157

 BRITISH COLUMBIA		Ministry of Forests 		RESIDUE SURVEY PLOT TALLY										PAGE _____ OF _____	
				LICENCE	C.P.	BLOCK	DATE			CERT	B LINE	STRIP	PLOT		MEAS. %
			Y	M	D	RET #			NO.	TY	SH				
													PIECE NO.		
													SPECIES		
													KIND		
													CLASS		
													LENGTH		
													TOP		
													E		
													BUTT		
													E		
													GRADE		
													BOR LINE		
													LENG		
													TOP		
													BUTT		
													D		
													OUTSIDE MEASUREMENT		
													FAR ADD		
													END LENGTH		
													COMMENT CODE		
													PIECE VOLUME (optional)		

PLEASE BE ADVISED THAT THIS INFORMATION MAY BE RELEASED UNDER THE FREEDOM OF INFORMATION AND PROTECTION OF PRIVACY ACT.

FS161 HVA 2001/04

Figure 5-14 Front of the FS 161 (Plot Tally Card)

																				PIECE NO.		
																				SPECIES		
																				KIND		
																				CLASS		
																				LENGTH	GROSS DIMENSIONS FOR PIECES INSIDE PLOT	
																				TOP	E	BUTT
																				E		
																				GRADE		
																				BOR LINE		
																				LENG	DEDUCTION FOR ROTH/HOLES	
																				TOP	BUTT	D
																				FAR END	OUTSIDE MEASUREMENT	
																				ADD LENGTH		
																				COMMENT CODE		
																				PIECE VOLUME (optional)		
NOTES _____																						
TIE-POINT _____																						
LOCATION _____																						
RESIDUE										ASSISTANT												
SURVEYOR										WEATHER												
SIGNATURE																						

FS 161 HVA 2001/04

Figure 5-15 Back of the FS 161 (Plot Tally Card)

This page has been left intentionally blank

6 Check Surveys

6.1 Check Surveys

The District Manager is responsible for conducting check surveys on timber sale licences, forestry licences to cut and permits issued under B.C. Timber Sales, major licences, woodlot licences, community forest agreements, community salvage licences and road permits.

Waste check surveys are activities included in the district's Internal Performance Measure.

Check surveys determine whether:

- a. surveys and oculars were properly planned and conducted,
- b. waste measurements and classifications were carried out according to the
- c. *Provincial Logging Residue and Waste Measurement Procedures Manual*,
- d. maximum allowable errors specified under Section 6.3 were not exceeded, and
- e. field assessments and reports were completed and submitted on schedule.

To enable the district to conduct check surveys while the survey crew is on site, a Block Survey Plans notification should be submitted to the District Manager at least 30 days prior to expected field work. Any changes to scheduled field work should be communicated to the district as soon as possible to facilitate rescheduling of check surveys. It is the Ministry of Forests, Lands, Natural Resource Operations and Rural Development prerogative to conduct a check survey at any time. If the survey crews will not be on site during the check survey, then the plot cards must be submitted to the district office no later than 1 week after the completion of the survey on that block.

6.2 Check Survey Standards

Check surveys verify that the field measurements are taken and recorded correctly. The check survey will re-measure all the pieces that should have been measured in the original plot. The survey or parts of a survey of a waste assessment area or a reporting unit can be accepted or rejected based on the results of the check survey.

In addition to meeting the requirements in Section 6.3 (Maximum Allowable Errors), waste surveys should meet the minimum sampling intensities requirements.

Field Services staff may check more than the minimum requirement if it is necessary to ensure compliance with the manual standards (i.e., previous check(s) showed borderline acceptable work).

The Ministry of Forests, Lands, Natural Resource Operations and Rural Development waste check surveys standards are:

6.2.1 Number of Blocks

1. Cutblock Option.

To check at least 10 percent of the measured cut blocks to a minimum of at least one cut block. This applies to both major licensees and the BC Timber Sales waste assessment areas.

- a. To check all plot cards, reports, and data entry.

2. Aggregate Option.

To check a minimum of 10 percent of the measured cut blocks in each reporting unit to a minimum of at least one block.

- a. To check 10 percent of the plot cards for every block against the plot listing report for data entry errors or incorrect methods of recording plot information.

3. Ocular Estimates

- a. To check at least 10 percent of the available waste assessment areas.

6.2.2 Check Requirements

In check surveys, the following number of plots and items are re-measured:

1. Cutblock Option

Dispersed Area:

- a. at least 10 percent of the plots in each selected block,
- b. a minimum of two plots or at least 1 plot per stratum, whichever is greater,
- c. check and account for all standing trees not harvested,
- d. check plots are properly located.

Accumulations:

- e. at least 10 percent of the plots in each selected block,
- f. a minimum of 2 plots, or at least 1 plot per stratum, whichever is greater

2. Aggregate Option

- a. at least 10 percent of the plots in the selected blocks must be checked,
- b. at least 2 plots per stratum, whichever is greater in each selected block,
- c. check plots are properly located, and
- d. check and account for all standing trees within the selected waste assessment area.

If more than one crew conduct surveys within the reporting unit, each crew should be checked on a weighted basis.

3. Ocular Estimates

- a. check reported estimates are representative of the waste levels on site, and
- b. check and account for all standing trees not harvested.

6.3 Maximum Allowable Errors

Measurement of a random selection of sample plots within a cut block is used to assess the acceptability of the survey results. The items to be checked and their acceptable limits of errors are specified below.

6.3.1 Net Volume or Value

Exceeding the parameter for either the net volume or net value of waste (avoidable and unavoidable) may be grounds for rejection of the survey.

Net Volume	
(Coast and Interior)	The net volume of waste for all checked plots must not vary by 10 percent from the net volume of waste determined by the check surveyor.
Net Value	
(Coast and Interior)	<p>The net value of waste for all checked plots must not vary by 10 percent from the net value of the waste determined by the check surveyor.</p> <p>The net value is derived by multiplying the volume of each species/grade combination by the applicable twelve-month average stumpage rate of the timbermark pertaining to the species, grade and waste class.</p>

6.3.2 Individual Parameters

Although the net volume and value are the main determining factor for accepting or rejecting a survey, a survey may be rejected if any of the individual parameters have been exceeded.

Sample Error	S.E. % must fall within the indicated S.E. percent for the dispersed and accumulation areas on Tables 4-4 and 4-5 (Interior) or Tables 4-2 or 4-3 (Coast).
Horizontal Distance	Strip to strip and plot to plot must be plus or minus 3 percent.
Area (stratum)	Plus or minus 2 percent.
Area (tree patches)	Plus or minus two (2) percent.
Bearing	Plus or minus 2 degrees (strip to strip or plot to plot).
Measure Percent	Plus or minus 10 percent.
Estimated Plots and Volumes	Plus or minus 20 percent.

Failure to follow the procedures specified throughout this manual may result in rejection of the survey. Some examples are:

- a. not locating plots in accordance with the assigned SPIF,
- b. incorrect location of plots (not using the correct POC and Grid Spacing Distance),
- c. locating plots in the wrong stratum,
- d. establishing more plots or less plots than required from the pre-determined sampling intensity,
- e. establishing a plot which samples outside the stratum it is located in,
- f. check surveyor is unable to audit the layout of the plots,
- g. check surveyor is unable to audit the plots and pieces due to poor marking, and
- h. using an incorrect method of selecting the piles to be sampled.

6.4 Acceptability of Block Results

If the net value and volume of the checked plots falls within the specified variance, then the survey is deemed to be acceptable unless the procedures specified in the manual were not adhered to (i.e., incorrect area used, log decks not included in the survey). Any obvious bias in grades and/or waste class which affect monetary billing will result in rejection of the survey.

If the net volume or value parameters are not met then the check survey will pinpoint the areas of weakness and allow that portion or entire survey to be redone.

If more than three check surveys or 30 percent of the checked waste assessment areas within a reporting unit are rejected, the district manager may order that all the waste assessment areas within that reporting unit be resurveyed.

Rejection of a survey will count against the waste surveyor for the purposes of validation of their certification. If more than one (1) waste surveyor worked on a waste assessment area, the rejection will count against the waste surveyor whose fieldwork caused the rejection.

6.5 Non-Compliance with Check Survey Standards

If the licensee's or contractor's survey work is rejected after a check survey, the District Manager may order the licensee or contractor to re-survey the entire waste assessment area or those portions of the original survey that caused the rejection. The re-survey must be completed within 60 days of the District Manager's notification.

The licensee or contractor will be responsible for any costs they incur in the re-survey.

A full or partial re-survey is subject to check surveys carried out at the District Manager's discretion.

6.5.1 Second Check Survey

A licensee or contractor who has been ordered to perform a re-survey may request a second check survey in writing to the District Manager.

The District Manager may have a second check survey performed by ministry personnel that were not involved in the first check survey.

If the second check survey:

- a. Finds the original survey in non-compliance with check survey standards,
 - i. the licensee or contractor will perform a re-survey to replace the original survey at his expense, and
 - ii. the licensee or contractor who requested the second check survey must pay to the government the charges, costs and expenses incurred by the government in respect of the second check survey.
- b. Finds the original survey in compliance with check survey standards,
 - i. the original survey stands, and
 - ii. no charges, costs and expenses are payable to the government.

6.5.2 Dispute Resolution (BCTS)

Where there are billable waste volumes on a Timber Sale Licence, Forestry Licence to Cut or permit issued by BCTS following a waste assessment conducted by BCTS, the Timber Sales Manager may notify the TSL holder about the waste assessment results. In the event that the TSL holder disputes the waste assessment results, the holder may submit a letter in writing specifying the grounds of dispute to the TSM within thirty (30) days of receiving the assessment results.

If the TSL holder is notified of the assessment results and no letter of dispute is received by the TSM, the TSL holder is deemed to have accepted the waste assessment results.

Once the TSM has forwarded the TSL waste assessments to the District Manager, subject to the field check that may be carried out by the district staff, the results are deemed to be final.

Any disputes relating to the check surveys and waste billing rates should be directed to the District Manager.

6.6 Material Disposed of Prior to Waste Assessments

If waste materials on a waste assessment area, landings, and roadside or spot accumulations are disposed of prior to the completion of waste assessments, the District Manager may bill the licensee monetarily and for cut control by using the higher of the district or the licensee waste volume average experienced for the stratum type in the past year or the best information.

Additionally, the District Manager may bill the licensee for the administration and field costs incurred in preparing the estimates.

7 Reporting

7.1 Data Compilation

A web-based system has been developed for processing waste assessment data. The system can be accessed at:

<https://apps.nrs.gov.bc.ca/ext/waste-for/>

For the Production system, users may follow the step by step procedures laid out in the *Waste System User Procedures Manual* that can be accessed at:

<http://www.for.gov.bc.ca/hva/rh/rwtraining/>

Effective January 1, 2005 all waste assessment data must be entered and submitted using the web based waste system.

7.2 Reporting Requirements

Licenses and contractors who utilize the web based Waste System must enter and submit the data for an entire waste assessment area within thirty days of completion of the field survey as specified under Section 2.4.

The final survey map for each waste assessment area must be included in the submission or in a manner acceptable by the District Manager.

If the log-loading-out phase causes the survey and report to be delayed, the delay time and the reason for that delay should be submitted to the District Manager.

The District Manager *may* extend these deadlines.

For major licenses and BCTS, survey reports submitted to the District Manager after November 15th may result in having invoices issued in the year following.

WASTE LICENCE	TIMBER MARK	CUTBLOCK			RETURN NUMBER			DATE			
					2	0					
LOG COUNT	W M R F		PLC DATE			E / C					
					2	0					
COMMENT (OPTIONAL)											
NOTATION											
R U NO.											
SPECIES	PRODUCT	GRADE	AVOIDABLE Y/N	PIECES	VOLUME			RATE			
										SURVEYOR'S SIGNATURE	
FS 702 HBS HVA 04/04											
Please be advised that this information may be released under the Freedom of Information and Protection of Privacy Act.											

Figure 7-1 FS 702 - Volume Estimate - Waste Form (Page 1)

INSTRUCTIONS FOR COMPLETING THE FS 702 VOLUME ESTIMATE - WASTE

This form is to be used to record waste volumes.

Right justify numbers in all the numerical fields and left justify characters in free-form fields, such as: Timber Mark. Underline the letter "S" and draw a line through the letter "o" to distinguish these letters from the numbers "5" and "0" (zero).

WASTE LICENCE:	Record the waste licence number of the surveyor. If not licenced, use: WACO For surveys done in the Coast Forest Region WASI For surveys done in the Southern Interior Forest Region WANI For surveys done in the Northern Interior Forest Region
TIMBER MARK:	Record the timber mark.
CUTBLOCK:	Record the cutblock.
RETURNNUMBER:	Record the surveyor's return number. As of January 1, 2004, start at 1 and continue to assign consecutively regardless of the scale site.
DATE:	Record the date this scale return was completed (e.g. January 15, 2004 = 20 040115).
LOG COUNT:	Record the total number of pieces on this return.
WMRF:	Record Waste Monetary Reducion Factor derived from the waste system.
PLC DATE:	Record the primary logging completion date.
E / C:	Record "E" for Endemic or "C" for Catastrophic whichever is designated for the timbermark.
COMMENT (OPTIONAL):	Record any comments you want to be keyed and stored in HBS.
NOTATION:	Text in this field will appear on the invoice.
RU NO:	Record the RU number reported in the waste assessment.
SPECIES:	Record the species code.
PRODUCT:	Default to blank.
GRADE:	Record the grade.
AVOIDABLE (Y / N):	Record "Y" for avoidable, "N" for unavoidable.
PIECES:	Default to 1.
VOLUME:	Record the volume in cubic metres.
RATE:	Record the stumpage rates in accordance with the waste manual.
SURVEYOR'S SIGNATURE:	The signature of the surveyor who completed this scale return.

Figure 7-2 Volume Estimate - Waste Form (Page 2)

7.3 Review of Reports

The Ministry of Forests, Lands, Natural Resource Operations and Rural Development staff will review all data submitted and either approve or reject the waste assessment(s).

7.3.1 Report Checklist

For waste assessment areas submitted using the Waste System go to Waste 102 and check

Coast	The selection of maturity is correct.
Interior	The selection of site type and condition is correct.

The bench mark calculations on the FS 702, WMRF is predicated on the correct selection of the above. Incorrect selections will result in rejection of the waste assessment area(s).

1. Area Summary Report:

- a. if there are standing trees present, ensure they are tallied and the reported area is correct.

2. Plot Piece Listing Report:

- a. use this report for field audit of the pieces.

3. Block Type Summary Report:

Volumes of kind (top trees, stumps, bucking waste, etc.) are reported for each stratum, block, and all blocks for information purposes.

4. Sampling Statistics:

a. Cut Block Option only.

- i. For blocks over 25 ha check that the sampling error requirement for the dispersed area has been met.

The sampling error requirement for blocks under 25 ha has been waived.

- ii. For blocks that have at least 3 ha of accumulation piles check that the accumulation sampling error requirement has been met.

The sampling error requirement for blocks with less than 3 ha of accumulations has been waived.

b. Aggregate Option only

- i. The sampling statistics and sampling summary reports don't need to be checked until the entire aggregate has been completed.
- ii. If the aggregate has been completed check that the sampling error requirements have been met.

If the sampling error requirements have not been met, check whether the licensee used a reasonable C.V. to determine the number of plots required and whether they established the required number of plots.

If the answer is yes then the aggregate is acceptable.

If the answer is no, a higher C.V. may be required from the licensee before approving the licensee's Annual Waste Assessment Plan for the following year.

5. FS 702 Waste Volume Estimate

Check the following:

- a. The waste surveyor number and return number (each subsequent FS 702 is incremented by one) have been filled out and that the waste surveyor has a valid Waste Surveyor Licence or Scaling Licence Number. If not, check for sponsoring forestry professional's name and number if plot surveys are submitted.

The old FS 72 format is no longer acceptable and must be converted to the current FS 702 format as in Figure 7-1.

7.4 Processing Waste Volume Estimate (FS 702)

Once checking is completed as per Section 7.3.1, the ministry will obtain and code the applicable waste rates on the FS 702.

7.4.1 Waste Rate

The application of a waste rate is dependent on whether there has been timber harvesting on a cutting authority, and whether there are areas of the cutting authority that reside within a Fibre Recovery Zone. If timber has been harvested on a cutting authority, then a waste rate is determined and applied on a waste assessment area basis.

7.4.1.1 Waste Rate Outside a Fibre Recovery Zone

1. Waste assessment areas with Harvesting

For waste assessment areas with harvesting, a waste rate is calculated for the waste assessment area using the weighted average stumpage rate charged for the sawlogs (graded sawlogs* on the Coast, and grade code blank sawlogs and/or grade code 1 and 2 sawlogs in the Interior) from invoices issued for a twelve-month period in respect of timber harvested under the applicable timbermark. The twelve-month period ends the month after the month that primary logging was completed for the waste assessment area. This applies to dispersed waste, accumulations and standing timber within the cutblock. Remaining areas of standing timber within the cutblock, that are left unharvested at the expiry, surrender, termination or cancellation of the cutting authority, would be waste billed using the same method, that is, the waste rate is based on the primary logging completion date for the cutblock. Refer to Appendix 3.1 for a description of determining the waste rate for cutblocks with harvesting.

Note that cutblocks may be split for waste assessment purposes (refer to page 5-38).

* Exclude all coniferous species Grade X, Hemlock and Balsam, Grade U.

2. Cutblocks with No Harvesting but Harvesting has Occurred on the Cutting Authority

If there has been no harvesting on the cutblock but there has been harvesting for the cutting authority, then the waste rate for the cutblock is derived using the average of the cutting authority's four quarterly timber appraisal stumpage rate (plus any bonus and levies where applicable) in effect during the twelve-months preceding the date of cutting authority's expiry, surrender, termination or cancellation, as the case may be. Refer to Appendix 3.2 for a description of determining the waste rate for cutblocks where no harvesting has taken place but there has been harvesting from the cutting authority.

3. Cutblocks with No Harvesting and No Harvesting has Occurred on the Cutting Authority

If there has been no harvesting on the cutblock, and there has been no harvesting on the cutting authority, then waste billings do not apply to cutblocks upon expiry, surrender, termination or cancellation of the cutting authority, as the case may be.

7.4.1.2 Waste Rate Within a Fibre Recovery Zone

1. Applicability of Waste Rates

The Coast Fibre Recovery Zone (FRZ) has geographic boundaries for Immature, Mature and Immature, and Mature Crown Timber. The applicability of these boundaries is based on:

1. The FRZ boundaries in effect on the date the waste survey is initially submitted into the Waste System, and
2. The maturity of the cutblock as assessed under the timber merchantability specifications in section 1.2.
 - a. For a waste assessment area to be considered within an FRZ, the maturity of the cutblock must be the same as the FRZ geographic boundaries it is contained within. For example:
 - A mature cutblock in a mature FRZ is in the FRZ
 - A mature cutblock in an immature FRZ is not in the FRZ

Waste assessment areas with any portion of the harvest area located within a Fibre Recovery Zone (FRZ) will be billed using the waste rate derived in this section, **unless exempted below. Fibre recovery zone rates apply to all strata in a waste assessment area.**

The items listed below are not subject to a Fibre Recovery Zone waste rate and are billed using the procedure in section 7.4.1.1:

- i. All avoidable western red cedar waste volume,
- ii. Areas within a Fibre Recovery Zone harvested using helicopter logging methods, and
- iii. Forestry licences to cut with stumpage rates determined under Chapter 7 of the *Coast Appraisal Manual*, master **licenses** to cut, and occupant **licenses** to cut.

Refer to Appendix 8 Waste Benchmarks in the Coast Area and Fibre Recovery Zone (FRZ) Waste Rates for guidance on application.

2. Fibre Recovery Zone Waste Rate Calculation

The following rates will apply to waste from timber originating in Fibre Recovery Zones **unless exempted above**:

- i. The avoidable conifer grade X, Y and grade U hemlock and balsam waste volumes will be billed at the rates applicable under section 1.2.4.1
- ii. Deciduous species within a Fibre Recovery Zone will be subject to the waste rate applicable under section 1.2.5
- iii. The waste rate for coniferous sawlog grades other than those listed in (i) for:
 - a. major licensees,
 - b. community forest agreements,
 - c. woodlot licenses,
 - d. road permits, and
 - e. forestry licences to cut with stumpage rates not determined under Chapter 7 of the *Coast Appraisal Manual*,will be:
 - the waste rate calculated for each species and grade under section 7.4.1.1 **multiplied by the FRZ adjustment factor**.

Where:

- **The FRZ adjustment factor under this subsection is 1.**

- iv. The waste rate for timber sale licenses for coniferous sawlog grades other than those listed in (i) will be the greater of:
 - \$2.00 per m³, or
 - (Stumpage rate – obligation adjustment) **multiplied by the FRZ adjustment factor**.

Where:

Stumpage rate = the total of the upset stumpage rate plus the bonus bid that must be paid by the licensee as per the *Coast Appraisal Manual* expressed in \$/m³

Obligation adjustment = the obligation adjustment \$/m³ for the district under Table 7-1 Timber Sales Licence Fibre Recovery Zone TOA adjustment values by district

The FRZ adjustment factor under this subsection is 3.

Table 7-1 Timber Sales Licence Fibre Recovery Zone Obligation Adjustment Values by District

District	Obligation Adjustment \$/m3
DCK	29.87
DCR	24.96
DHG	32.10
DNC	35.29
DNI	26.07
DSC	24.10
DSI	23.00
DSQ	29.19

7.5 Interior Log Grade Changes

The Interior log grade changes are scheduled to take effect April 1, 2006. Areas logged prior to April 1, 2006 will be waste surveyed using the grades in effect before the grade change subject to conditions specified below.

The cut blocks that will be affected are:

1. Blocks that are harvesting complete prior to April 1, 2006, but are surveyed and/or entered into the Waste System after April 1, 2006.
2. Blocks with areas partially harvested prior to April 1, 2006.

For those affected cut blocks, licensees have until April 30, 2006 to submit to the District Manager (or for timber sale licence*, the Timber Sale Manager) a listing of cut blocks where timber harvesting is completed and/or partially completed as of March 31, 2006.

The listing for completed cutblocks must include: Licence, CP, Block #s, Geographic Location, Block net area, and in addition for partially completed blocks, the areas harvested prior to the grade change, and maps clearly showing the harvested areas.

*For fixed rate Timber Sale Licences advertised before December 2, 2005, and expiring on or after April 1, 2006, the deadline for declaring harvesting complete is extended to May 31, 2006.

When the survey data for the cut blocks in the listing are entered into the Waste System, **the Survey Date on screen 102 must be artificially changed by the licensee to March 13, 2006**. This step will enable the grade listing in effect prior to April 1, 2006. When these blocks are submitted, the actual survey date must be entered on the comment box. Additionally, for administrative purposes, **the primary logging completion date must be entered with a date no later than February 28, 2006** for the purpose of the waste rate twelve-month average calculations.

Conditions:

The survey results for both **harvested** and partially harvested block in the listing must be submitted within sixty days from the date of notification or snow free. Those blocks that are submitted late must use the log grades in effect April 1, 2006.

Forest Districts will monitor on the basis of the survey date and the comments entered for ensuring the cut blocks submitted are indeed blocks eligible to use the grades in effect prior to April 1, 2006.

Any waste created after April 1, 2006, must be graded using the new grades in effect April 1, 2006.

Appendices

Appendix 1 Glossary

Accumulations	Areas where waste are concentrated (e.g., at landings and along roadsides).
Accuracy	The nearness of a measurement to the actual value of the variable being measured.
Aggregate Option	Sampling and measurement of a waste reporting unit comprised of an approved aggregation of cut blocks and/or cutting authorities. It cannot cross a District or T.S.A. boundary.
Allowed Stump Height	The higher of:
	1. Timber merchantability specification stump height,
	2. Height specified in District Manager letter for heavy snow packs,
	3. The minimum distance from the ground on the high side of a stump up to a point above a physical obstruction which allows for safe falling. Allowed stump height minus TMS stump height = unavoidable piece.
Allowable Annual Cut (AAC)	The rate of harvest determined by the Chief Forester for Timber Supply Areas (TSAs) and Tree Farm Licences (TFLs), and by the District Manager for Woodlot Licences (WLs), and the rate of harvest specified in a licence or in a management and working plan.
Availability of Cut Blocks	Cut blocks and partially completed cut blocks are available for waste assessments upon completion of primarily logging and the ground is sufficiently free of snow to allow for an adequate assessment to be carried out. Field assessments must be completed within sixty (60) days after primary logging and the survey reports must be submitted to the District Manager within thirty (30) days of completion of the field survey.

Avoidable Waste	Waste volumes left on the ground that could have been removed safely, were not physically obstructed and were not inaccessible.
Bias	Measurement bias occurs when the mean of the measured values differs from the mean of the actual values.
	Sampling bias occurs when certain sampling units are more likely to be included than others (lack of randomness).
	Statistical bias occurs when the expected value of the statistic differs from the population parameter.
Breakage	Breakage is defined as any piece, meeting the minimum diameter of the cutting authority, which is shorter than 3 m in length and broken at the large end or at both ends. Normal breakage is not usually recorded.
Bucking Waste	Bucking waste is defined as any pieces less than 3 m in length that has been cut at the large end, or at both ends. It has been cut through improper or careless bucking practices.
Chunk	A short piece of waste that has resulted from end trimming logs, or from breaking logs during extraction operations.
Closure Error	The square root of the sum of the squared sum of latitudes plus the squared sum of departures, which may also be expressed as a ratio to or percent of the perimeter length. A closure error of 1 percent will result in an area error of approximately 2 percent.
Coast	This refers to the Coast Forest Region.
Coefficient of Variation	A relative measure of variation, equal to the sample standard deviation expressed as a percentage of the sample mean.
Confidence	An expression of accuracy of sample estimates, usually assessed by confidence intervals, a specified proportion of which, such as 95 percent confidence intervals, contain the true population parameters.

Contractual Stump Height	The allowed stump height, specified in the minimum utilization standards of the cutting authority, as measured from the ground on the high side.
Cutblock	An area within which the holder of an agreement is authorized to harvest timber, as identified in: a) a cutting permit, or b) the agreement, if the agreement does not provide for cutting permits.
Cutblock Option	Each cutting block will be sampled as a separate population, and reported as a separate waste reporting unit.
Cut Control	The Ministry of Forests procedure for accounting the volumes of timber harvested under a licence as specified under Part 4 of the <i>Forest Act</i> .
Cutting Authority	Cutting Authority means a Timber Sale Licence, a Licence to Cut, a Road Permit, or a cutting permit issued under a Tree Farm Licence, Forest Licence, Timber Licence or a Woodlot Licence.
Dry grade 4 or Y	Dead and dry lumber reject that is not measured in waste.
Fixed-area Plot Sampling	A sampling method where each plot within a stratum is exactly the same size and shape.
Full Sampling Intensity (FSI)	A full sampling intensity survey on which a sampling error or hectare to plot ratio must be met as specified in Tables 4-2, 4-3, 4-4 and 4-5.
High Side (stumps)	The position where the ground meets the stump on the uphill side, ignoring any root flare, obstacles, vegetation, and loose matter that has accumulated at the base of the tree. Length measurements usually start from 30 cm above this point.
Interior	This refers to the Southern and the Northern Interior Regions.

Licensee	The holder of the cutting authority.
Log Grade	Those log grades that are defined in the Scaling Regulation.
Measure Factor	A visual estimate of the percentage of an accumulation that was physically measured and/or estimated. Recorded as the "measure percent."
Parent Block	A previously surveyed block that is representative, in terms of the level of dispersed waste, to the block being proposed for survey exemption.
Plot Sampling	The estimation of waste within a cutblock or reporting unit from sample plot measurements, and the determination of the sampling error associated with the plot estimates.
Population	The waste component within the waste reporting unit that is to be estimated by sample plot measurements.
Precision	The closeness, to each other, of repeated measures of the same quantity, expressed as Sampling Error or Standard Error of the sample estimate.
Primary Logging	The cutting of timber and the yarding of that timber to a central landing, road side, or drop area in a logging operation.
Primary Logging Completion Date	The date on which the yarding of all the timber that is cut in a cutblock to a central landing, roadside, or drop area in a logging operation is completed.
Reduced Sampling Intensity (RSI)	A reduced sampling intensity which may be applied to cutblocks that qualify (i.e., clean logging or low billing volumes). The plot requirement is one quarter of the minimum full sampling intensity using a C.V. of 100 percent. It applies only on dispersed subpopulation areas.
Reporting Unit	The area for which the waste is measured and reported. It may be either a cut block, several cutblocks, a licence, or part of a licence.

Reporting Unit Number	The unique number assigned by the Ministry of Forests to any one license within a waste reporting unit for a given year.
Reporting Year	The 12-month period in which the cut blocks in the waste reporting unit are first available for measurement. The District Manager will approve the 12-month period.
Radius Class Unit (rad)	The measurement of log or stump diameters to the nearest 2 cm of diameter (1 cm of radius), and as specified in the <i>Scaling Manual</i> .
Reserved Timber	Merchantable timber left after completion of primary logging that is reserved from cutting for silviculture, biodiversity and other specific forest management reasons.
Sampling Error (S.E.)	A measure of the variation among sample means is the standard error of the mean. It can be thought of as a standard deviation among sample means; it is a measure of the variation among sample means, just as the standard deviation is a measure of the variation among individuals. When we increase our confidence level above one standard deviation, i.e. two standard deviations for waste, we refer to the statistic as the sampling error. The waste calculations for sampling error include a finite population correction factor, which implies random sampling without replacement.
Standard Deviation (S.D.)	The Standard Deviation is the square root of variance. It characterizes dispersion of individuals about the mean and gives some idea whether most of the individuals in a population are close to the mean or spread out. On the average, about two-thirds of the unit values of a normal population will be within one standard deviation of the mean. About 95 percent will be within two standard deviations and about 99 percent within 2.6 standard deviations.
Stratum	A non-overlapping sub-unit of a subpopulation for which separate sampling statistics are calculated.

Stratification	The process of delineating strata boundaries within a subpopulation, where each stratum has unique characteristics (timber type, logging contractor, season or year logged).
Subpopulations	Subdivisions of the reporting unit or cut block (population). For example, the dispersed and accumulation volumes are each typically treated as subpopulations.
Timber	Trees, whether standing, fallen, living, dead, limbed, bucked or peeled.
Timber Merchantability Specification (TMS)	Means the merchantability specifications for stump height and diameter, log top diameter, slab thickness and log length described in this manual for the Coast and the Interior.
Timber Supply Area	Large contiguous areas of Crown land on which an annual allowable cut is calculated.
Trimming "Waste"	Avoidable waste that results from topping, slashing, bucking and end-trimming in a manner that does not conform to the merchantability specifications.
Unavoidable Waste	That component of the waste that is physically obstructed or cannot be removed for safety or environmental reasons.
Variance	The mean of squared deviations of observations about a sample mean (these deviations or differences from the mean are called residuals).
Waste	Timber except timber reserved from cutting, whether standing or felled, which meets or exceeds the timber merchantability specifications described in this manual, that was not removed from the cutting authority area.

Appendix 2 Standing Stem Harvesting

A2.1 Standing Stem Harvesting

Standing stem harvesting is a new logging method which utilizes a helicopter to selectively log components of a forest stand. Trees selected for harvesting are based on the licensees' pre-determined requirements (e.g., species, diameter, value). A 100% cruise is required for all trees that will be harvested in standing stem harvesting.

Once a tree has been selected, the tree is topped off at the height dependent on the tree diameter and the lifting capacity of the type of helicopter used in the operation. At the stump level, the tree is not cut through and enough holding wood is retained to enable the tree to remain standing.

After the tree has been topped and jugged, the helicopter moves into position, and utilizing a grapple attached to the end of a long cable line, lifts the log straight into the air and gently lowers it to the ground nearby.

A2.2 Waste Accounting Methodology

The harvested trees are scattered over a wide area throughout the cutblock and are often inaccessible, it is not cost effective to utilize a plot system for surveying the site.

Since 100% of the trees are cruised, the difference between the scaled volume and the cruised volume is used to derive the waste volumes for standing stem harvesting. Applicable for this harvesting method only, if the scaled volume exceeds the cruised volume, there is no waste to be reported for the block.

To submit a waste assessment for standing stem harvesting blocks, create a separate Reporting Unit, enter the volume of waste as an Ocular Estimate using the grade breakdown from the cruise and include a copy of the cruise summary as an attachment.

Appendix 3 Waste Rate Determination

The determination of the waste rate is dependent on whether there has been timber harvesting on a cutblock and whether there are portions of the waste assessment area that are located within a Fibre Recovery Zone

A3.1 Cutblocks with Harvesting

For cutblocks with harvesting, the waste rate for the cutblock is derived from the weighted average stumpage rate charged for the sawlogs (graded sawlogs on the Coast, grade code blank sawlogs and/or grade code 1 and 2 sawlogs in the Interior) in invoices issued during the 12-month period ending one month after the month in which primary logging on the cutblock area was completed. The formula to be used is:

$$WR = TS/TV$$

Where:

WR	=	Waste Rate for the cutting authority.	
TS*	=	Total billed sawlog stumpage (sum of Upset Stumpage*, and Bonus Bid) for the twelve-months prior to one month after the month primary logging was declared completed on the cutblock.	
		*	Include silviculture and development levies.
TV*	=	Total billed volume (accumulated volume in cubic metres that derived the total billed stumpage for the sawlogs) for the twelve-months prior to one month after the month primary logging was declared completed on the cutblock.	

*Effective April 12, 2007, TS and TV will exclude (on the Coast only), all coniferous species X grade, and Hemlock and Balsam, Ugrade.

A3.2 Cutblocks with No Harvesting

If there has been no harvesting on the cutblock, but there has been harvesting from the cutting authority, then the waste rate for the cutblock is derived using the average of the cutting authority’s four quarterly timber appraisal stumpage rates (plus any bonus and levies where applicable) in effect during the twelve-months preceding the date of the cutting authority's expiry, surrender, termination or cancellation, as the case may be. The formula to be used is:

$$WR = ACASR$$

Where:

WR	=	Waste Rate for the cutblock.
ACASR	=	Average Cutting Authority Stumpage Rate over the four quarters preceding the expiry, surrender, termination or cancellation date.

Example 1

If Cutting Authority A (CP A) became effective on September 5, 2003, and expires on September 4, 2005, then the ACASR is the simple average of the four quarterly stumpage rates for CP A as at October 1, 2004, January 1, 2005, April 1, 2005 and July 1, 2005.

Example 2

If Cutting Authority B (CP B) became effective on April 20, 2005, and is surrendered on September 5, 2005, then the ACASR is the simple average of the April 20, 2005 and July 1, 2005 stumpage rates for CP B.

A3.3 Coniferous Waste Rates Within a Fibre Recovery Zone

Refer to Section 7.4.1 of this manual.

A3.4 Deciduous Waste Rate

1. Deciduous Waste Rate outside a Fibre Recovery Zone

For deciduous species, the waste rate is either the appraised rate, or if there is no appraised rate, use the specified fixed rate for the species in the *Coast* or *Interior Appraisal Manuals*, plus any bonus bid and levies where applicable.

2. Deciduous waste rate inside a Fibre Recovery Zone

The applicable waste rate is the rate under section 1.2.5.

A3.5 Occupant Licence to Cut

For OLTCs that require the licensee to deck the timber but do not allow the licensee to remove the timber, the waste rate is based on the Average Sawlog Stumpage Rates by District and Species as per Section 7.1 of the *Coast Appraisal Manual* or Table 6-1, Average Sawlog Stumpage Rate by Forest Zone and Species in the *Interior Appraisal Manual*.

Appendix 4 Riparian Management Zone (RMZ)

A4.1 Assessment Method

For waste assessments to be conducted within the riparian management zone, the assessment method should commensurate with the silvicultural system used, as follows:

•	single tree selection	-	100 percent piece scale, or 50 m ²
•	group selection	-	100 percent piece scale or (circular or rectangular) plot of 50 to 400 m ² that best fits the group selection harvested area.

Refer to Section 4.7 for assessing partial cutting (variable retention) cutblocks, and Section 5.7.2 for stratum codes.

A4.2 Stream Clean-out

For stream clean-out conducted in accordance with the Riparian Management Area Guidebook, the waste classification procedures are as follows:

1. Where a log is left across a creek, classify the log as unavoidable for environmental reasons.
2. If a creek was machine cleaned and it was reasonable to recover the log pieces, classify the pieces as avoidable.
3. If a creek was hand cleaned and the log was bucked into small segments and thrown out of the creek channel, classify the pieces as unavoidable.

Appendix 5 Waste Benchmarks

1. Benchmarks

The following waste benchmarks in cubic meters per hectare will be used for monetary billing of avoidable waste and applied on an individual cutblock basis:

Coast

Harvest System	Immature	Mature
Ground base	10 m ³ /ha	10 m ³ /ha
Cable/ Skyline	10 m ³ /ha	25 m ³ /ha
Helicopter	10 m ³ /ha	35 m ³ /ha

The waste benchmark selection is based on the actual harvest method used within the waste assessment area.

Interior

Interior	Dry Belt	Transition Zone	Wet Belt
Normal	4 m ³ /ha	10 m ³ /ha	20 m ³ /ha

The Waste Benchmark zones are identified using the document 'Interior Forest Residue and Waste Benchmark and BEC Zones 2006' available at the website below:

http://www2.gov.bc.ca/assets/gov/farming-natural-resources-and-industry/forestry/docs/timber-pricing/residue-and-waste/bec_zones_linkage_to_interior_waste_benchmarks.pdf

The waste benchmark volume of a cutblock is derived by multiplying the value of the benchmark with the total of the dispersed, accumulation and standing trees sub population areas reported in a waste assessment of the cutblock.

2. Waste Benchmarks for Mature Blocks in the Coast Area with More Than One Conventional Harvest Method

- a. Mature cutblocks in the Coast Area containing more than one conventional harvest method will receive a prorated benchmark. The benchmark will be based on the **actual** harvest method **areas within a waste assessment area**.
- b. For cutting authorities that:
 - i. **require an appraisal data submission**, the benchmark will be based on:
 1. **the areas from the initial appraisal data submission when the post harvest condition of the cutblock matches this submission, or**
 2. **the areas listed in a professional certification, or**
 3. **the areas listed within the post harvest appraisal data submission as outlined in the *Coast Appraisal Manual* (as available).**
 - ii. do not require harvest method submission in the appraisal **data** submission, the harvest method proration **calculation must be** submitted with the waste assessment and signed off by a forest professional.
- c. The benchmark will be calculated as follows and rounded to the nearest whole number:

$$\frac{(CY+SL)(25 \text{ m}^3/\text{ha}) + (GS)(10\text{m}^3/\text{ha})}{(CY+SL+GS)}$$

Where:

CY = cable yarding **harvest method area (ha)**

GS = ground skidding **harvest method area (ha)**

SL = Skyline Logging **harvest method area (ha)**

- d. Where only a portion of a cutblock is being surveyed and submitted, the proration will be based on the harvest **method area (ha)** for the entire cutblock being surveyed regardless of which portions are harvested.
- e. Benchmark proration calculations must be attached in the Waste System for each waste assessment area.

3. Benchmark Calculations and Billings

Avoidable waste volumes in sawlog grades X or better (Coast), and conifer sawlog grades 1 and 2 (Interior) from the dispersed, accumulated and the standing tree subpopulations of the cutblock will be applied to the benchmarks.

Where the avoidable waste volumes in sawlog grades are below the established benchmark for the waste assessment area, no monetary billing of avoidable waste in sawlog grades will be made.

Where the avoidable waste volumes in sawlog grades are above the established benchmark for the waste assessment area, monetary billings will be made on the sawlog grade volumes exceeding the benchmark.

Avoidable waste volumes in grade Y or 4 will not be applied to the benchmark but will be billed monetarily in all cases.

4. Benchmark Eligibility

The benchmarks are administered on an individual waste assessment area basis, regardless of whether the waste assessment area is in the Cutblock, the Aggregate or the Ocular Reporting Unit. Therefore, each waste assessment area must be individually assessed to determine whether the avoidable waste within the waste assessment area is above or below the benchmark.

No waste benchmarks will be applied to log decks that in the determination of a forest officer are subject to scaling at a scale site or being field scaled. Such log decks must be clearly marked by the licensee and not to be included in the waste assessment.

Waste benchmarks do not apply to the unharvested cutblocks.

No waste benchmark will be applied to an area of a waste assessment area where the wasted timber volume compromised the site-specific forest management objective(s). The area must be delineated, waste assessed and billed separately from the remaining area of the waste assessment area.



	COAST Worksheet for Waste Billing Against Benchmarks	Ministry of Forests	
To be Completed by Licensees			
Licence No.	CP No.	Cut Block	
Timber Mark		Reporting Unit No.	
Primary Logging Completion Date		Cut Block Net Area ha	
Location		Stand/Site Type	
Calculations			
Avoidable waste sawlog (X or better)	=	_____ M ³ /ha.....	(A)
Established benchmark	=	_____ M ³ /ha.....	(B)
(A) - (B)	=	_____ M ³ /ha.....	(C)
If (C) < or = 0.0000, stop			
If (C) > 0.0000, proceed as follows:			
Waste Monetary Reduction Factor (WMRF) =	(C)/(A) =	_____(D)
		(to four decimals)	
To be Completed by Forest Service			
Processing			
If (C) is < or = 0.0000, on FS 702, code:			
Avoidable all species sawlogs (X or better):		\$0.00/m ³	
Avoidable all species grade Y:		\$0.25/m ³	
Unavoidable all species all grades:		\$0.00/m ³	
If (C) is > 0.0000, request average sawlog rate from HBS			
Average coniferous sawlog rate (HBS) =		\$ _____/m ³(E)
Deciduous sawlog rate =		\$ _____/m ³(F)
On FS 702, code			
Avoidable hembal (J or better) and all other conifer (U or better)	(D x E) =	\$ _____/m ³	
Avoidable hembal U and grade X all species =	D x \$0.25/m ³	\$ _____/m ³	
Avoidable deciduous species sawlogs:	(D x F) =	\$ _____/m ³	
Avoidable all species grade Y:		\$0.25/m ³	
Unavoidable all species all grades:		\$0.00/m ³	
Approved by Forest Officer (signature)		Date	

Figure A-1 Sample of Worksheet for Waste Billing Against Benchmarks (Coast)



	INTERIOR Worksheet for Waste Billing Against Benchmarks	Ministry of Forests	
To be Completed by Licensees			
Licence No.		CP No.	Cut Block
Timber Mark		Reporting Unit No.	
Primary Logging Completion Date		Cut Block Net Area ha	
Location		Stand/Site Type	
Calculations			
Avoidable waste conifer sawlog (grades 1 and 2)	=	_____	M ³ /ha..... (A)
Established benchmark	=	_____	M ³ /ha..... (B)
(A) - (B)	=	_____	M ³ /ha..... (C)
If (C) < or = 0.0000, stop			
If (C) > 0.0000, proceed as follows:			
Waste Monetary Reduction Factor (WMRF) =	(C)/(A) =	_____(D) <small>(to four decimals)</small>
To be Completed by Forest Service			
Processing			
If (C) is < or = 0.0000, on FS 702, code:			
Avoidable all species sawlogs (grades 1 and 2):		\$0.00/m ³	
Avoidable all species grade 4:		\$0.25/m ³	
Unavoidable all species all grades:		\$0.00/m ³	
If (C) is > 0.0000, request average sawlog rate from HBS			
Average coniferous sawlog rate (HBS) =		\$ _____ /m ³(E)
Deciduous sawlog rate =		\$ _____ /m ³(F)
On FS 702, code			
Avoidable coniferous species sawlogs (D x E) =		\$ _____ /m ³	
Avoidable deciduous species sawlogs: (D x F) =		\$ _____ /m ³	
Avoidable all species grade 4: \$0.25/m ³			
Unavoidable all species all grades: \$0.00/m ³			
Approved by Forest Officer (signature)		Date	

Figure A-2 Sample of Worksheet for Waste Billing Against Benchmarks for Blocks

Appendix 6 Coast Grading

Due to the timber pricing changes made to Hembal U grade and all coniferous X grade, the followings grade rules apply to blocks surveyed after May 1, 2006.

A6.1 Bucking Waste and Long Butts

- a. Old Growth - No change other than default to J grade.
- b. Second growth:
- c. Bucking Waste with less than an 8 rad top default to U grade,
- d. Bucking Waste with an 8 rad or larger top default to J grade.
- e. A piece of bucking waste that is less than 50% of its original log diameter (at the butt) with a broken end and gross length of less than 0.4 metres is not required to be measured. All three criteria must be met or the piece must be recorded. The piece cannot be folded (accounting for volume) to become less than 0.4 metres.

All Bucking Waste that is 50% or more of the original log diameter and meets the TMS must be measured and recorded.

A6.2 Stumps

- a. Old/Second Growth:
- b. \leq 12R default to U grade,
- c. \geq 13R default to J grade.
- d. Unavoidable grades are the same as avoidable grades.
- e. Severe Ring shake = X grade. (Severe ring shake is defined as covering at least 50% of the volume of the stump).
- f. Stumps cannot be graded as U, X or Y grade due to rot or missing wood.

A6.3 Logs

Use the following rules:

- a. Logs less than 5 meters in length and bucked on the butt end will be graded as if they were 5 metres long.

Logs (except spruce and cypress) with an undercut butt and less than 5.0 metres to the point where 8 rads disappears cannot be better than U grade. Spruce and Cypress logs with an undercut butt and less than 4.0 metres to the point where 8 rads disappears cannot be better than U grade.

- b. Logs broken at both ends or broken at the butt end will be graded according to the scaling grade rules.
- c. Logs greater than 12.8 metres in length, the diameter used for determining the grade of the entire log is the diameter (inside bark) measured at the point 12.8 meters from the large end. Do not pencil buck, scale and grade as one piece.

A6.4 Standing Trees

Use the following rules:

- a. Old Growth/Second Growth.
- b. Trees that are greater than 12.8 metres to the timber merchantability specifications top diameter will be pencil bucked in 12.8 metre segments with each segment classified and graded accordingly.

For example, a 15.0 metre tree would be entered as a 12.8 metre log and a 2.2 metre piece of bucking waste with each piece graded according to its dimensions. However, if the grade of all pieces in the pencil bucked tree is the same, then record the tree as one piece.

A6.5 Breakage

Where there is evidence of intentional or excessive breakage, classify as avoidable, and grade the piece as if it were a 5 metre long log.

Appendix 7 Waste Benchmarks in the Coast Area and Fibre Recovery Zone (FRZ) Waste Rates

