



Coast Area

Non-Tabular Development Cost Procedures

Effective December 15, 2021

Approved by:

December 15, 2021

Allan W. Bennett, RPF
Director, Timber Pricing Branch



Non-Tabular Development Cost Procedures Document Change Log

These effective **December 15, 2021**, Non-Tabular Development Cost Procedures contain the following changes by section as compared to the procedures effective **December 15, 2020**:

Section	Change
2.4(4)	Added wording that end haul bank height plus hourly can not be combined with other types
2.5(6)	Added wording regarding tabular culvert cost
2.6(3) and (5)	Wording change
3.1.2(2)(b)	Added wording that bank height plus hourly end haul projects must be used if specified in written contract
Type 6 Eligible Costs	Wording change and added wording for hourly and materials only and bank height plus equipment hourly
Type 6 Ineligible Costs	Wording change and added wording for hourly and materials only and bank height plus equipment hourly
Type 6 Supporting Information	New wording on geometric design information and added wording on road building contract
Type 12	Wording change
Type 14	Wording change
Appendix 1 Definitions	Added road builder contract definition and wording change for stabilized road surface
Appendix 4	New NDC Form
Appendix 5	NDC Procedures – Equipment Stand-By Time

Table of Contents

Non-Tabular Development Cost Procedures Document Change Log 2

1 Administration 1

1.1 Authority 1

1.2 Purpose 1

1.3 Application 1

1.3.1 Transition: Non-Tabular Development Cost Projects started prior to 1

April 1, 2019..... 1

1.4 Roles and Responsibilities 2

1.4.1 Licensees (including BCTS) 2

1.4.2 District Appraisal Staff 2

1.4.3 District & Regional Engineering Staff 3

1.4.4 Coast Area Pricing Appraisal Staff (regional appraisal staff)..... 3

1.4.5 Timber Pricing Branch Staff..... 3

2 Non-Tabular Development Cost Qualifications..... 4

2.1 Cost Item Qualifications..... 4

2.2 Forest Planning and Administrations Cost Items 4

2.3 Road Management Cost Items..... 5

2.4 Combined NDC Project(s)..... 5

2.5 Generally Accepted Cost Items in a NDC Project..... 6

2.6 Generally Ineligible Cost Items in a NDC Project 6

3	Submission Standards	8
	3.1 Methods for Determining Project Costs.....	8
	3.1.1 Qualified Registered Professional Estimate.....	8
	3.1.2 Detailed Calculation.....	8
	3.1.2(1) Pre-Construction	8
	3.1.2(2) Post-Construction	9
	3.1.3 Tendered Contract (Arm’s Length Competitive Bids).....	9
	Table 1 – NDC Documentation Requirement.....	10
	3.2 General NDC Submission Requirements.....	11
4	Project Types	12
	Type 1 Bridge Exceeding Tables in the CAM.....	12
	Type 2 Drainage Structure Maintenance or Upgrade	15
	Type 3 Barging of Bridge Structure Component(s).....	18
	Type 4 Major Culvert Installation	20
	Type 5 Ford Construction	22
	Type 6 End Haul Construction.....	24
	Type 7 Overland Construction & Large Fills	27
	Type 8 New Road Construction Exceeding Table Values in CAM.....	31
	Type 9 Road Reactivation	33
	Type 10 Road Reconstruction	35
	Type 11 Road Upgrade.....	37

Type 12	Placement of Stabilizing Material	39
Type 13	Retaining Wall Construction	42
Type 14	Pipeline Crossing Construction.....	44
Type 15	Powerline Works.....	46
Appendix 1 - Definitions.....		47
Appendix 2 - Supervision and Certification Costs		58
Appendix 3 - References		61
Appendix 4 - New NDC Form		62
Appendix 5 - NDC Procedures – Equipment Stand-By Time		63

1 Administration

1.1 Authority

These Non-Tabular Development Cost (NDC) Procedures have been approved by the Director of Timber Pricing Branch. The *Coast Appraisal Manual (CAM)* requires that these procedures, as updated from time to time, be followed for the submission of a NDC project in the appraisal of a cutting authority.

When a discrepancy is identified between the CAM and these procedures, the CAM will prevail. Coast Area Pricing appraisal staff (regional appraisal staff) may provide clarification in these situations, as applicable.

1.2 Purpose

The purpose of this document is to identify the appraisal requirements for NDC projects in the Coast Area. This includes the:

1. submission standards required in an appraisal or reappraisal; and
2. supporting information that may be required by the regional or district appraisal staff.

1.3 Application

These procedures are applicable to development projects that require NDC(s) in an appraisal or reappraisal of a cutting authority.

1.3.1 Transition: Non-Tabular Development Cost Projects started prior to April 1, 2019

1. For an NDC project where construction started prior to April 1, 2019, the project cost may be included in an initial appraisal data submission, a post-harvest appraisal data submission and/or reappraisal of a cutting authority whose original effective date is on or after April 1, 2019. The project cost may be submitted using the:
 - a. detailed Engineering Estimate for Coast Stumpage Appraisals (DEE) effective March 31, 2019, or
 - b. non-Tabular Development Cost procedures effective April 1, 2019.
2. Where the licensee submits project costs using the DEE, written documentation must be provided regarding the project construction:
 - a. start and completion dates; and
 - b. same documentation requirements of the DEE effective March 31, 2019.
3. Subsections 1.3.1(1)(a) and 1.3.1(2) do not apply to NDC projects with a construction completion date on or after April 1, 2020, regardless of the project start date being prior to April 1, 2019, unless otherwise approved by the regional appraisal coordinator.

1.4 Roles and Responsibilities

1.4.1 Licensees (including BCTS)

1. Ensure the cost effectiveness of their non-tabular development costs (this is a key element in the Post-Harvest Appraisal Reconciliation Model (PHARM)) by ensuring a licensee's forest professional(s) is acting in the best and most efficient manner relating to layout, design and construction of timber extraction infrastructure;
2. Ensure their NDC project submissions are reasonable for the site conditions, consistent with the CAM, and meet the requirements outlined in these procedures;
3. Include in Electronic Commerce Appraisal System (ECAS) the appropriate level of submission content; and
4. Provide additional supporting information where the aspects of the project are beyond the normal experience for the project type in the district and/or as requested by district, regional appraisal and/or engineering staff to complete the review of a NDC project and determination of a stumpage rate.

1.4.2 District Appraisal Staff

1. Verify the eligibility of each NDC project submitted;
2. Check for completeness and ensure sufficient detail is provided that meets the standard contained within these procedures;
3. Check the construction equipment rates, and all unit costs to ensure they are reasonable and based on the site conditions or local knowledge;
4. Check the calculations submitted;
5. Provide advice on the site conditions of specific engineering projects to regional appraisal staff;
6. Assist with the ongoing updates to these procedures as necessary; and

7. Review BCTS submission to:
 - a. advise on project eligibility, or if required, forward details to regional appraisal staff for interpretation; and
 - b. provide a recommendation for acceptance of the NDC to regional appraisal staff.

1.4.3 District & Regional Engineering Staff

1. Review bridge and major culvert upgrades on Forest Service Roads (FSR);
2. Provide advice on engineering practices, **as well as** the site conditions, productivities or specific engineering projects;
3. Provide advice to regional appraisal staff on the eligibility of complex structures;
4. Assist with the ongoing updates to these procedures as necessary; and
5. Assist regional appraisal staff in review of NDC projects when requested.

1.4.4 Coast Area Pricing Appraisal Staff (regional appraisal staff)

1. Provide interpretation, advice, and guidance on the eligibility of specific NDC projects upon request;
2. Provide recommendations to Timber Pricing Branch regarding updates to these procedures; and
3. Assist Timber Pricing Branch with updating these procedures as necessary.

1.4.5 Timber Pricing Branch Staff

1. Consider changes to the list of eligible projects listed in these procedures;
2. Update these procedures as necessary; and
3. Post these updated procedures on the Timber Pricing Branch website.

2 Non-Tabular Development Cost Qualifications

2.1 Cost Item Qualifications

A NDC project may be used in an appraisal or reappraisal of a cutting authority if the holder of the cutting authority incurred or will incur that kind of cost, on the basis of commonly used cost-effective road and drainage structure construction practices. Costs will not be accepted where the required regular maintenance has not been undertaken or where a structure failure is caused by improper installation or use.

NDC project cost item(s) that are otherwise considered part of other tenure obligation adjustments (TOA) cost(s), or part of the cost(s) represented in the Market Pricing System Final Estimated Winning Bid formula, are not eligible projects or costs in a NDC project.

2.2 Forest Planning and Administrations Cost Items

The CAM includes activities which are part of the Forest Planning and Administration Cost (FPA) under section 5.2 of the CAM. These costs should not be included in an NDC project.

Additional items or activities that may be related to a NDC project, which are considered FPA costs that should not be included in the NDC project are:

1. Emergency transportation vehicles and first aid attendants;
2. Stream assessments for the determination of stream class for operating areas;
3. Supervising or monitoring by a Registered Professional Biologist or Environmental Monitor except as described in section 2.5;
4. Bridge and/or culvert design, supervision and certification for drainage structures whose cost is accounted for using a CAM tabular methodology;
5. Any environmental protection works except those specifically listed in section 2.5; and/or
6. Qualified Registered Professional (QRP) costs where the professional is a company staff member or a contractor on long term (one year or more) or renewable shorter length contract (these costs are accounted for through the annual cost survey and are accounted for in the forest planning and administration tenure obligation adjustment).

2.3 Road Management Cost Items

Items normally covered under Road Management in the CAM, if specifically required as part of a NDC project, may be included in a NDC project. Sufficient information must be provided justifying the inclusion in the NDC project of any items normally covered under Road Management in the CAM.

For example, replacement of pipe culverts < 0.9 metres diameter on an active road as part of a NDC submission, is a legitimate cost to include if the culvert is impacted by the project construction. Culvert replacement of pipe culverts < 0.9 metres diameter on an active road as a separate activity is considered part of the road management cost.

2.4 Combined NDC Project(s)

1. Subject to section 2.4(3), End Haul Construction (Type 6), Overland Construction and Large Fills (Type 7 but excluding bridge approaches), and/or Retaining Wall Construction (Type 13) projects contiguous with a Road Reactivation (Type 9), Road Reconstruction (Type 10), or Road Upgrade (Type 11) project, may be combined into one of the following projects, as applicable:
 - a. Road Reactivation (Type 9);
 - b. Road Reconstruction (Type 10); or
 - c. Road Upgrade (Type 11).
2. Subject to section 2.4(3), End Haul Construction (Type 6) projects contiguous with a Retaining Wall Construction (Type 13) project where both projects are associated with new road construction, may be combined into the End Haul Construction (Type 6) project.
3. Combined projects that may result in one continuous uninterrupted section of road - as provided in these procedures and in accordance with the requirements of the CAM - must share the same name (Section ID) as it appears in the Forest Tenures Administration system (road registry). **New road end haul construction appraised using a bank height category cost component cannot be combined with other non-tabular development cost project types.**
4. Other NDC project combinations may be further detailed as described in section 4.0 of this document.

5. Licensees must provide the information required in Appendix 4b for combined NDC road sections that have been included in the NDC project cost total as a result of:
 - a. section 2.4(1), 2.4(2) or 4.0 of this document; or
 - b. the CAM.

2.5 Generally Accepted Cost Items in a NDC Project

The following cost items are considered **in addition to the FPA cost** and may be submitted as part of an NDC project:

1. Traffic control where required based on traffic (public and/or industrial), location and nature of the road works;
2. Mobilization and demobilization of ground equipment required for the NDC project that is not already in proximity for harvesting or road construction activities.
3. Site specific environmental management plans and related required supervision specific to an NDC project;
4. Stream diversion or isolation works where required as part of the approvals by Ministry of Environment or Fisheries and Oceans Canada, or where required by a QRP as part of the NDC project design;
5. Design costs, subject to Section 2.2(6);
6. **Tabular culvert material costs from CAM Table 5-4 Column B;**
7. Supervision and certification costs as per Appendix 2;
8. Freight of materials required; and
9. Provincial Sales Tax (PST) if it is clearly identified in an invoice.

2.6 Generally Ineligible Cost Items in a NDC Project

The following cost items are generally ineligible to include in an NDC project (note: this list is not complete – other items may be ineligible):

1. Right of way harvesting operations (i.e. felling, skidding, yarding, bucking, or sorting); the reason for this is that harvesting activities are accounted for in the stumpage rate of the timber harvested under the road permit mark;
2. Goods and Services Tax (GST) , the reason for this is that the license receives GST credits on inputs to develop the final product (lumber, chips, pulp, etc.) while the purchaser of the final products pays the GST;
3. Bank height tabular road costs, **except as specified in End Haul Construction (Type 6);**

4. Tabular bridge costs;
5. Tabular culvert costs **which include installation (CAM Table 5-4 Column A)**;
6. Projects where the required regular maintenance has not been undertaken or where a structure's failure is caused by improper installation or use;
7. Pest control;
8. All post-logging treatments;
9. Landing burning (includes fireguards);
10. Roadside debris piling and disposal;
11. Skid and/or back spar trail construction, and associated rehabilitation or slashing;
12. Slashing; and
13. Log material cost(s) for bridges or culverts;
 - a. Stumpage is not an acceptable cost, as logs should be obtained from **the** local area to the project. Every effort must be made to source log material locally as 'Camp Run Timber', which means the logs are scaled with a "CU" event code in the Scaling Control System (SCS) resulting in logs being scaled but not billed.
 - b. If no local log material is available, the costs that may be included are the stumpage rate paid for the logs (if scaled and billed), associated transportation of the logs; and preparation of logs at the project site. A rationale must be provided in this case.

3 Submission Standards

3.1 Methods for Determining Project Costs

There are three (3) methods for determining costs for a NDC project:

1. Qualified Registered Professional Estimate;
2. Detailed Calculation; and
3. Tendered Contract.

3.1.1 Qualified Registered Professional Estimate

A licensee representative submitting an NDC project in an appraisal may choose to submit a development project as a QRP estimate.

These types of estimates are for projects that have not been completed (pre-construction) on the date that the Initial ADS status of "SUBMIT" occurs in ECAS. A QRP estimate is appropriate for common projects that have known project costs for the same project type in the same area.

Cost estimates previously completed under the "Detailed Engineering Estimate for Coast Stumpage Appraisal – Cost Estimate Methodology (CEM)" in effect on March 31, 2019, may be considered by the licensee to be a 'QRP estimate'.

3.1.2 Detailed Calculation

A licensee representative submitting a NDC project in an appraisal may choose to submit a development project as a Detailed Calculation.

3.1.2(1) Pre-Construction

If the development work has not been completed prior to the licensee's submission of the initial appraisal data submission (ADS) in ECAS, the detailed calculation must be based on the estimate of volumes included in a geometric road design, or in the case of drainage and other structures, site specific plans and/or designs.

Sources of equipment productivity include Chapter 3 of the 1993 BC Ministry of Forests Engineering Manual, or manufacturer productivity guides.

Equipment and labour rates **are determined as follows:**

- from the CAM Appendix I, or
- **where the actual or expected piece of equipment is not in Appendix I then the equipment rate must be obtained from the appropriate rental rate guide (Blue Book) or**
- **from the Blue Book equipment category equivalence, or**

- where a required piece of equipment is neither in Appendix I nor the Blue Book use the actual invoiced rate.

Costs for materials may be sourced from local quotes.

The level of the site survey completed should be consistent with the complexity of the project and the level of detail required for the calculation of volumes. For bridges and major culverts, the level of site survey is outlined in the Joint Practice Board's *Guidelines for Professional Services in the Forest Sector - Crossings V.2*.

3.1.2(2) Post-Construction

- a. If the development work has been completed prior to the time of the licensee's submission of the appraisal or reappraisal in ECAS, the detailed calculation must be based on the actual equipment type and hours worked, hours in labour or professional services, materials and costs.

Equipment and labour rates are determined as outlined in 3.1.2(1).

- b. If the licensee's new road end haul construction payment is specified in a written road builder contract as a combination of bank height category and hourly equipment, the end haul construction project (Type 6) must be appraised using this method.

3.1.3 Tendered Contract (Arm's Length Competitive Bids)

The licensee has the option of submitting the results of an arm's length competitive bid process as a NDC for a specific project, a portion of a project, or a combination of projects. The contract and results used in an appraisal or reappraisal must meet the provisions outlined in the CAM. The tendered contract cost must not include items that are ineligible.

Table 1 – NDC Documentation Requirement

NDC Method	Planned/Initial ADS		¹ Ministry Review of Post-Harvest ADS	
	Pre-Construction /Development	Post-Construction /Development	Project <\$25,000	Project \$25,000 or more
Qualified Registered Professional Estimate	Based on experience, and/or internal cost tracking of a “reasonable” cost for the project. Also refer to Section 3.1.1. Limited supporting documentation.	QRP estimate is not acceptable in an initial appraisal data submission if the project has been constructed. A Detailed Calculation or a Tendered Contract is required.	Physical evidence or documentation requirements as per section 2.3.4(3)(b) of the CAM, or The lowest bid amount and confirmation of either:	Full documentation requirements as per section 2.3.4(3)(c) of the CAM, or The lowest bid amount and confirmation of either:
Detailed Calculation	Estimate of hours, equipment & rates, materials, labour, professional service costs.	Actual hours, equipment & rates, materials, labour, professional service costs.	A limited tender with 3 or more bids received, or A public (advertised) tender.	A limited tender with 3 or more bids received, or A public (advertised) tender.
Tendered Contract	The lowest bid amount and confirmation of a: Limited tender with 3 or more bids received, or Public (advertised) tender.			

¹Information is to be retained by Licensees and made available to the Ministry upon request during the office or field review stage (as per the CAM).

3.2 General NDC Submission Requirements

All NDC submissions must include a project summary containing the following:

1. NDC project type number (from within these procedures) under which the road section or drainage structure project qualifies;
2. Cutting authority:
 - a. Licence;
 - b. Cutting permit number (if applicable); and
 - c. ECAS Id (if available);
3. Location:
 - a. Cutblock identification (optional);
 - b. Road Name(s) (use exact name (Section ID) as it appears in the Forest Tenures and Administration system (road registry), DO NOT use colloquial names);
 - c. Station start and station end;
 - d. Section length; and
 - e. Bridge structure (corporate asset) number;
4. Development category (reconstruction/replacement [RR] or new construction [New]);
5. Project cost method (i.e. QRP Estimate, Detailed Calculation, or Tendered Contract);
6. List of machine model & category, hours and cost (if applicable);
7. List of labour type, hours and cost (if applicable);
8. List of material(s) and cost (if applicable);
9. Tendered Project Bid Cost (if applicable);
10. Freight and haulage cost of material only (if applicable);
11. Engineering, certification & supervision cost (if applicable);
12. Map(s) showing geographic location and nature of works with sufficient detail (if applicable);
13. Appendix 4b NDC Cost Form Addendum (if applicable);
14. Applicable CAM Version;
15. Project type cost total; and
16. Supporting information as required.

4 Project Types

The following project types are acceptable for submissions as a NDC project.

Type 1 Bridge Exceeding Tables in the CAM
--

Description

This project type is for bridge installation that exceeds the CAM bridge tables or where a portable bridge is reused, as described in the following sub-types:

1. Bridges with abutment height, crib height, or bridge span length that exceed the table limits in the CAM (i.e. Table 5-2 or Table 5-3);
2. Multi-span bridges;
3. Bridges that require piles to be driven more than 13 metres in depth;
4. Extra wide bridges that are > 4.9 metres wide (inside measurement between guardrails at mid-span of the bridge) that require one or more additional stringers and/or extra- width deck panels to be installed;
5. Portable bridges that are reused in another location; or
6. **Concrete span bridges.**

For guidance and additional information regarding the completion of site surveys and bridge designs, both the Joint Practices Board's *Guidelines for Professional Services in the Forest Sector - Crossings V.2*; and Appendix E of the *Forest Service Bridge Design and Construction Manual* can be referenced.

Application

A bridge structure should be based on the planned life span and design standard of the road. In general, for this project type, the following costs may apply, but are not limited to:

1. Production of site specific site plan and general arrangement as per 2.2(6);
2. Purchase cost of bridge superstructure (only for new superstructures unless a used superstructure is purchased from an arm's length third party and was never previously included in the appraisal of a cutting authority by the receiving licensee), if applicable;
3. Purchase cost of bridge substructure and associated components;
4. Site preparation, at the new bridge location;
5. The installation of the superstructure and substructure at the new bridge location;

6. Supply, placement and compaction of structural fill (volumes and materials as per design);
7. Development, supply and placement of rip rap or scour protection (volumes as per design); and
8. Supply and installation of fenders, delineators, hazard markers and required signage.

For this project type, sub-types A to D, the following costs may apply, but are not limited to:

9. Production of structural design drawings for new and re-designed structures;
10. Transportation (freight) of materials from the reasonably closest possible supplier;
11. Supervision and/or certification by a QRP as per Appendix 2.

For this project type, sub-type E, the following costs may apply, but are not limited to:

12. Removal and transportation costs for the purposes of re-installation of the superstructure or substructure, including mobilization and demobilization of equipment to the new bridge location if equipment is not already in the area for harvesting and/or road construction;
13. The removal of abutments if reused at the portable bridge's new location;
14. Repair of bridge superstructure and substructure if required; and
15. Installation of portable bridge structural components at the new site.

Project Type Combination

NDC projects under this project type are generally stand-alone projects as identified by road name and station (start & end) location. Any associated large fills (Type 7B) and/or barging (Type 3) must be combined into this project.

Eligible Costs

This project type may contain all applicable costs associated with the bridge

construction to the top of the decked surface.

Ineligible Costs

Costs that are ineligible for inclusion are:

1. The removal of abutments at the portable bridge's original location, if the abutments are not going to be reused at another location (This is considered part of the deactivation and is not an acceptable cost item.);
2. General deactivation costs such as cleanup and rehabilitation of the original bridge site, or the removal and disposal of other materials (not reused);

3. A bridge superstructure or substructure cost which has previously been included in the appraisal of a cutting authority of any of the licensee's license(s) or licence(s) the licensee has an interest in.

Supporting Information

1. Structural design drawings, site plan, and general arrangement documentation for the bridge installation (if applicable).
2. A pre-construction geometric design that includes plans, profiles, cross-sections, mass haul and cut and fill volume estimates (if applicable).
3. All portable bridges are required to be assigned a bridge structural (corporate asset) number that is affixed to the structure at the time of initial installation. Any existing portable bridge in use must also be assigned a tracking number and be identified on a list with the number and location submitted to the district.

Type 2 Drainage Structure Maintenance or Upgrade**Description**

This project type is for drainage structure maintenance or upgrade for sub-types:

- A. Structural Maintenance to the:
 - 1. bridge's substructure and superstructure component(s); or
 - 2. major culvert structural components; or
- B. Structural Upgrade to the:
 - 1. bridge's substructure and superstructure component(s); or
 - 2. major culvert structural components.

Application

Drainage structure maintenance or upgrade should be based on the planned life span and design standard of the road.

In general, for this project type, the following costs may apply, but are not limited to:

- 1. Structural maintenance which is the repair and/or replacement of a structural component(s) or load bearing member of a bridge or the structural components of a major culvert.

Structural maintenance is limited to the repair of, or replacement with, similar or comparable materials that meet the original design standard.

Structural maintenance includes:

- a. replacement of rip rap when specified by a QRP;
- b. repair or replacement of structural fill when specified by a QRP;
- c. removal and re-installation of fill when done in conjunction with structural works;
- d. repair or replacement of bridge substructure components;
- e. repair or replacement of bridge superstructure components;
- f. repair or replacement of panels on ACROW® bridges;
- g. replacement of guard rail or approach barrier system;
- h. any structural steel repairs as designed and recommended by a QRP, to maintain the current design load rating;
- i. replacement of concrete deck panels or structural steel deck panels, where

- replacement is required on more than 10% of the deck area;
 - j. replacement of timber decking, where replacement is required on more than 50% of the deck area;
 - k. replacement of gravel deck surfacing on gravel decked structures, when done in conjunction with structural works;
 - l. replacement of running planks on a log bridge, where replacement is required on more than 50% of the deck area;
 - m. repair or replacement of structural plates for multi-plate pipe (open bottom or pipe arch culverts) structures; and
 - n. repair or replacement of structural components for non-structural plate structures, this includes replacement of failed (collapsed) pipe sections.
2. Structural upgrade where structural changes are proposed that increase the original design load rating or enhance the physical properties of a drainage structure. Upgrade of drainage structures includes:
 - a. installation of new rip rap that is specified by a QRP;
 - b. to increase the design load rating by replacement of cross-ties with a larger dimension;
 - c. replacement of timber decks with concrete deck panels or structural steel deck panels, which result in an increase in either design lifespan or design load rating;
 - d. any structural steel works as designed by a QRP, to increase the design load rating;
 - e. installation of supplemental structural support (e.g. needle beams, etc.);
 - f. lengthening of existing major culverts, where justified; and
 - g. removal and re-installation of fill when done in conjunction with structural works.
 3. For maintenance and upgrade projects not explicitly stated in either of the above lists, the work should be referred to the Regional Appraisal Coordinator for a decision as to whether the project qualifies for as an NDC under this project type.
 4. The requirement to replace or repair a structural component(s) must be documented in an inspection by a qualified bridge inspector.
 5. Where replacement of or upgrade to concrete deck panels or structural steel panels are proposed, the project details must be referred to the district engineer.
 6. District engineering staff, 30 days prior to the commencement of works, must be notified of all upgrades on Forest Service Road bridges and major culverts; where required by the district engineer, the work may require design and/or supervision by a QRP.
 7. Structural maintenance and structural upgrades may be carried out under the

supervision of and should follow a design prepared by a QRP.

Project Type Combination

NDC projects under this project type are stand-alone projects as identified by road name, and station (start & end) location.

Eligible Costs

This project type may contain all costs associated with the repair, replacement and/or upgrade of structural components.

Ineligible Costs

Costs associated with the repair or replacement of asphalt or concrete topping of bridge decks or approaches are ineligible for inclusion.

Supporting Information

1. Bridge (corporate asset) number;
2. Copy of the most recent documented inspection by a qualified bridge inspector indicating the condition of the structure;
3. Specific details regarding the individual structural component requiring repair or replacement (for structural repairs);
4. Georeferenced photos of structural components affected;
5. Copies of drawings of the repair, replacement or upgrade for those components requiring a design by a QRP;
6. Copies of previous inspection reports with information regarding maintenance history of bridge component(s) being repaired, replaced, or upgraded; and
7. Structural design drawings, site plan, and general arrangement documentation for the project installation.

Type 3 Barging of Bridge Structure Component(s)**Description**

This project type is for barging bridge structure component(s), as described in the following sub- types:

1. bridges under Table 5-3 of the CAM;
2. bridges that exceed the table values in CAM Table 5-3;
3. permanent bridges barged to the installation location; and
4. portable bridges moved to the installation location, or from the original installation location, by barge, to a new location.

Application

In general, for this project type, the following costs may apply:

1. loading of the material starting at the time the first bridge component is loaded on the barge and ending when the last component is loaded onto the barge;
2. barging transport of material via the shortest reasonable one-way travel route from the:
 - a. barge loading location (at the site that results in the reasonably shortest barging distance to where the bridge material will be used);
 - b. barge off-loading location (at the site that results in the reasonably shortest barging distance to where the bridge material will be used);
3. unloading of the bridge material starting at the time the first component is unloaded at the destination and ending when the last component is removed from the barge; and
4. proration of barging cost must occur if equipment or material unrelated to the bridge project is also transported on the barge.

Project Type Combination

NDC projects under this project type are secondary projects and the cost must be submitted in the same cutting authority appraisal data submission(s) as the bridge whose structural components are being barged.

Eligible Costs

The prorated cost of barging.

Ineligible Costs

Costs that are ineligible for inclusion are:

1. barging of equipment that will also be used in road construction or harvesting activities accessible from the barge off-load location at time of bridge work;
2. barging costs of materials or equipment that are not directly associated with the drainage structure project; and/or
3. costs resulting from barge diversion.

Supporting Information

The location the barge was loaded and unloaded.

Type 4 Major Culvert Installation**Description**

This project type is for a major culvert installation, as described in the following sub-types:

1. culverts > 1800mm (1.8 metres) in diameter or equivalent to a corrugated steel pipe > 1800mm in diameter,
2. elliptical pipe culverts having a span > 1800mm, or
3. open bottom or pipe arch culverts having a span > 2130mm.

For guidance and additional information regarding the completion of site surveys and bridge designs, both the Joint Practices Board's *Guidelines for Professional Services in the Forest Sector – Crossings* and Appendix E of the *Forest Service Bridge Design and Construction Manual* can be referenced.

Application

In general, for this project type, the following costs may apply, but are not limited to:

1. production of a site specific site plan and general arrangement as per 2.2(6);
2. purchase cost of culvert components;
3. site preparation;
4. supply, placement and compaction (volume and materials as per design) of:
 - a. foundation;
 - b. structural fill envelope;
 - c. road's subgrade;
 - d. stabilized road surface material (if required); and
 - e. shaping of stabilizing material;
5. development, supply and placement of rip rap or scour protection (volumes as per design);
6. for embedded culverts, the cost to re-establish the stream channel and streambed through the pipe;
7. supply and installation of any roadside barriers, hazard markers or required signage; and
8. supervision/certification costs as per Appendix 2.

Project Type Combination

NDC projects under this project type are stand-alone projects as identified by road name, and station (start & end) location.

Eligible Costs

This project type may contain all costs associated with construction of the project to the top of the stabilized road surface and structure costs.

Ineligible Costs

Costs that are ineligible for inclusion are bank height tabular road costs. The reason for this is Major Culvert Installation accounts for construction to the top of the stabilized road surface.

Supporting Information

Structural design drawings, site plan, and general arrangement documentation for the culvert installation (if applicable).

Type 5 Ford Construction**Description**

This project type is for construction of a drainage structure constructed with non-erodible material designed and built so that water may pass over or through the road prism.

Figure 5-1 -Ford Example Design Diagram:

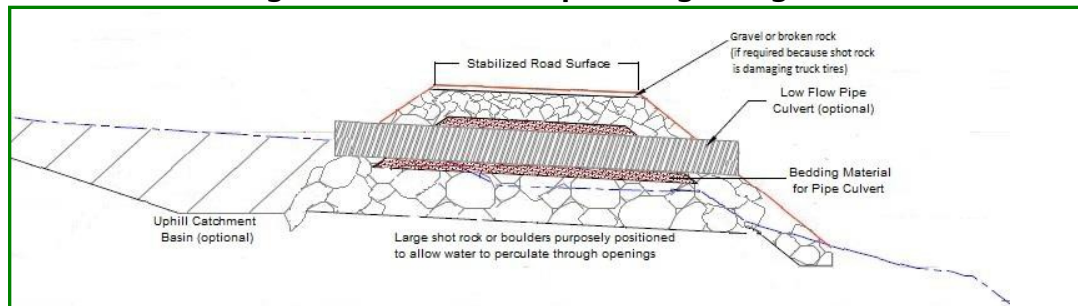
**Application**

In general, for this project type, the following costs may apply, but are not limited to:

1. grubbing & stripping;
2. development of the ford road prism structural material;
3. placement of ford structural material;
4. subgrade construction;
5. stabilized road surfacing material (if required);
6. placement & shaping of stabilizing material; and
7. culvert material (if required).

Project Type Combination

NDC projects under this project type are generally stand-alone projects of continuous uninterrupted section of road, road name, and station (start & end) location.

Eligible Costs

This NDC project may contain all costs associated with construction of the project to the top of the stabilized road surface and **including** culvert material.

Ineligible Costs

Costs that are ineligible for inclusion are bank height tabular road costs. The reason for this is Ford Construction accounts for construction to the top of the stabilized road surface.

Supporting Information

Structural design drawings and site plan documentation for the ford construction project (if applicable).

Type 6 End Haul Construction**Description**

This project type is for end haul construction occurring when excavated material excess to that road section must be placed in a truck and removed at least 10 metres because all or some of the material cannot be side casted, due to:

1. steep terrain or steep sites; defined as having a natural downslope $\geq 55\%$ measured from the outside edge of the road prism or where the angle of repose of the soil precludes its use as fill material in the road section;
2. sensitive sites; defined as sites where the sidecasting of the excavated soil material would cause a material adverse effect on forest resources (e.g. streams, visuals, wildlife habitat, etc.); or increase the risk of slope failure; or
3. unstable terrain as defined by a terrain specialist. The required terrain stability assessment (TSA) may include recommended site-specific actions to reduce and/or manage the landslide hazards and risks resulting from the road construction or development. Based on the TSA, a QRP prescription may be completed that outlines specific design requirements which must be included in the geometric road design.

For guidance and additional information regarding the completion of a TSA refer to the Joint Practice Boards' *Guidelines for Professional Services in the Forest Sector - Forest Roads; The Guidelines for Management of Terrain Stability in the Forest Sector; Guidelines for Professional Services in the Forest Sector – Terrain Stability Assessments; and Land Management Handbook Number 18 - A Guide for Management of Landslide-Prone Terrain in the Pacific Northwest.*

Application

Partial end haul is considered End Haul Construction and all road construction works within the road section are to be captured in the project.

In general, for this project type, the following costs may apply, but are not limited to:

1. geometric design, with design cutslope for:
 - a. Other material of $\frac{1}{2}$ to 1;
 - b. Rock of $\frac{1}{4}$ to 1;
2. grubbing & stripping;
3. excavation of material at road head;
4. trucking of excess material to the nearest feasible waste or spoil location;
5. culvert materials (if required by QRP design);

6. subgrade construction;
7. stabilized road surface material (if additional material is required); and
8. shaping of stabilizing material.

Project Type Combination

NDC projects under this project type are generally stand-alone projects of continuous uninterrupted section of road, road name, and station (start & end) location. If considered for combination with other project types, consult the applicable version of the CAM and Section 2.4 of these procedures.

Eligible Costs

This project type may contain all costs associated with construction of the project to the top of the stabilized road surface and culvert material (if required in the QRP design for the road section).

When the end haul project is a detailed calculation based upon:

1. equipment and labour hours and material only; or
2. a written road builder contract that specifies payment using bank height category plus invoiced rock truck hours, excavator hours, and equipment hours for spoil site management, then the appraised project cost may use the bank height category tabular road cost applicable to the road section measure-up and culvert material (if required in QRP design for the road section). Note this only applies to new road construction.

Ineligible Costs

Costs that are ineligible for inclusion are:

1. bank height tabular road costs where the appraised project cost is based on equipment hours only, the reason for this is End Haul Construction accounts for construction to the top of the stabilized road surface;
2. any equipment hours, materials, labour, or supplies related to the drilling and blasting of the road section where the appraised project cost is based on a written road builder contract that specifies payment using bank height category plus invoiced rock truck hours, excavator hours, and equipment hours for spoil site management.

Supporting Information

1. a pre-construction geometric design that includes: plans, profiles, cross-sections, mass haul and cut and fill volume estimates will be promptly submitted within one business day if requested;
2. a TSA completed by a terrain specialist (if applicable); or
3. a QRP's rationale specifying the requirement for end haul or partial end haul construction.

4. road building contract when the road section was appraised using tabular bank height category road costs.

Type 7 Overland Construction & Large Fills

Description

This project type is for Overland Construction due to the following sub-types:

- A. Weak soils; which is defined as trucking in extensive fill material (see “Overlanding” page 81-82 of the *Forest Road Engineering Guidebook* for a more detailed description) required for filling over undisturbed natural, thick organics and/or weak soils, or over shallow depressions on stable terrain with slopes < 20%; or
- B. Large fills at:
 - 1. Bridge approaches when the fill material required is > 0.8 metres in depth (station Y) to the edge of the bridge (station Z) for filling in (Figures 7-1; 7-3) or building up (Figure 7-2);

Figure 7-1 - Bridge Approach Large Fill - Example Diagram

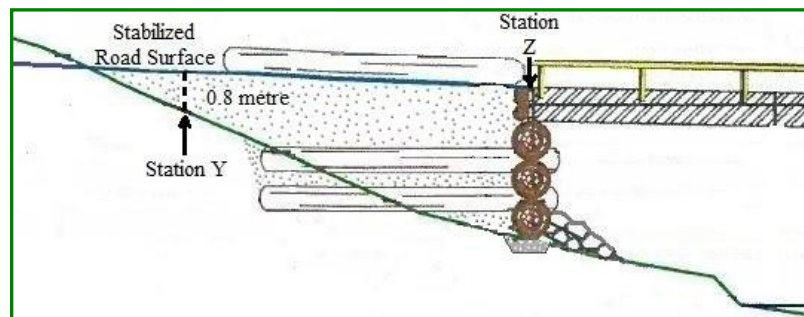

Figure 7-2 - Bridge Approach Large Fill Build-up - Example Diagram

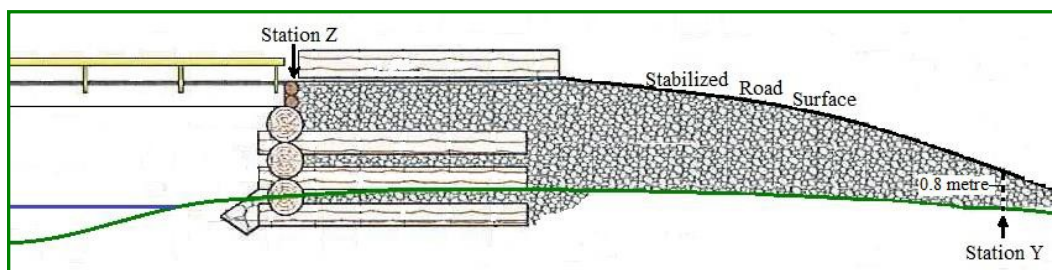
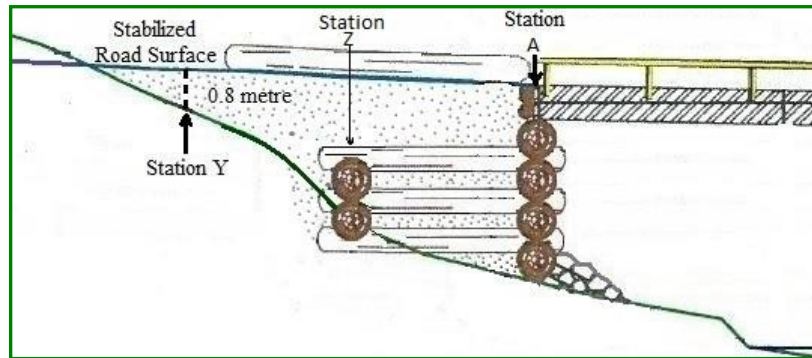
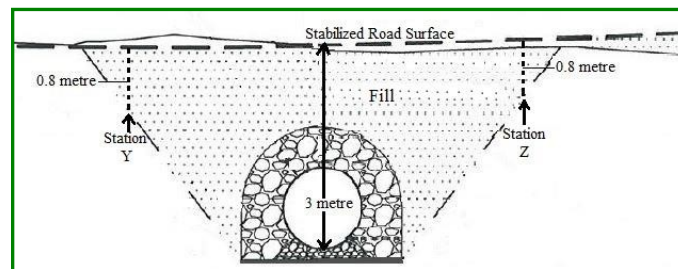

Figure 7-3 - Bridge Approach Large Fill with Cribbing - Example Diagram



2. Deep culverts where the distance from the stabilized road surface to the bottom of the fill below the culvert is > 3.0 metres (Figure 7-4). A large fill for a deep culvert begins when the depth of fill is > 0.8 metres (station Y) and ends when the depth of fill is < 0.8 metres (station Z); or

Figure 7-4 - Culvert Large Fill - Example Diagram



3. Large fill in a road section where the contiguous length of road is ≥ 20 metres and at least one point within that length is a minimum of 3 metres in depth from the stabilized road surface (Figure 7-5). The large fill for a road section project begins when the depth of fill is ≥ 0.8 metres (station M) and ends when the depth of fill is < 0.8 metres (station N).

Figure 7-5 - Large Fill in a Road Section - Example Diagram

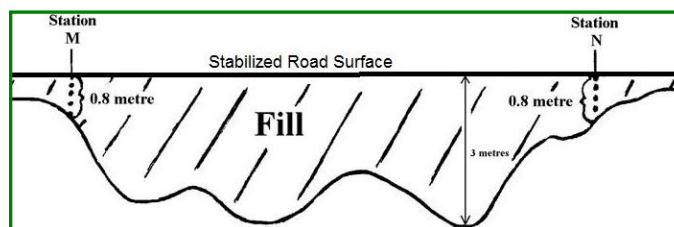

Application

In general, for this project type, the following costs may apply, but are not limited to:

1. Weak Soils:
 - a. supply, transportation (truck), placement, spreading and compaction of fill material;
 - b. supply, transportation and installation of geo-synthetics;
 - c. installation of corduroy, puncheon and/or brush mats;
 - d. culvert materials (if required in design);
 - e. subgrade construction;
 - f. road stabilizing material; and
 - g. shaping of stabilizing material; or
2. Large Fills:
 - a. geometric design (if applicable);
 - b. grubbing & stripping;
 - c. fill material:
 - i. development of fill material if required;
 - ii. trucking;
 - iii. placement; and
 - iv. compaction (if required by QRP design);
 - d. culvert materials if required;
 - e. subgrade construction;
 - f. road stabilizing material; and
 - g. shaping of stabilizing material.

Project Type Combination

1. NDC projects under this project type are generally stand-alone projects of continuous uninterrupted section of road, road name, and station (start & end) location. If considered for combination with other project types, consult the applicable version of the CAM and Section 2.4 of these procedures.
2. NDC projects under this project type occurring due to large fills at a bridge approach must be combined into one project with the associated bridge (only if the associated bridge qualifies as an NDC project).

Eligible Costs

This project type may contain all costs associated with construction of the project to the top of the stabilized road surface and culvert material (if required in QRP design for the road section).

Ineligible Costs

Costs that are ineligible for inclusion are bank height tabular road costs, the reason for this is Overland Construction & Large Fills accounts for construction to the top of the stabilized road surface.

Supporting Information

A pre-construction geometric design that includes plans, profiles, cross-sections, mass haul and cut and fill volume estimates.

Type 8 New Road Construction Exceeding Table Values in CAM**Description**

This project type is for new road construction, as described in the following sub-types:

1. construction and upgrading of main access roads with a stabilized road surface > 6 metres accessing at least 300,000 cubic metres of timber over the next 10 years;
2. road construction on uphill side slopes that are over 150 percent;
3. road construction on terrain with two or more gullies over 10 m deep at centerline in a 300 m section;
4. switchbacks with over 10,000 m³ cubic metres of excavation volume to complete the designed grade percent and horizontal alignment;
5. approaches to major highway junctions requiring asphalt to shed dirt; and
6. bank height road sections with rock faces exceeding 7.50 metres in vertical height.

Application

In general, for this project type, the following costs may apply, but are not limited to:

1. geometric design (if applicable);
2. grubbing & stripping;
3. fill material:
 - a. development of fill material if required;
 - b. trucking;
 - c. placement; and
 - d. compaction (if required by QRP design);
4. culvert materials (if required by QRP design);
5. asphaltting the running surface where the Ministry of Transportation and Infrastructure requires;
6. subgrade construction;
7. road stabilizing material; and
8. shaping of stabilizing material.

Project Type Combination

NDC projects under project sub-type A to D are generally stand-alone projects of continuous uninterrupted section of road, road name, and station (start and end) location.

NDC projects under project sub-type E are stand-alone projects if the associated road section qualifies as a bank height tabular road cost, otherwise the project is to be combined into the relevant associated NDC project.

If otherwise considered in combination with other project types, consult the applicable version of the CAM and Section 2.4 of these procedures.

Eligible Costs

This project type may contain all costs associated with construction of the project to the top of the stabilized road surface and culvert material (if required in QRP design for the road section).

Ineligible Costs

Costs that are ineligible for inclusion are bank height tabular road costs, the reason for this is this project type accounts for construction to the top of the stabilized road surface.

Supporting Information

1. A pre-construction geometric design that includes (if applicable): plans, profiles, cross- sections, mass haul, and cut and fill volume estimates; and
2. A QRP rationale specifying the requirement for the projects under project sub-types A to F.

Type 9 Road Reactivation**Description**

This project type is for road reactivation, defined as the reestablishment of a road prism to achieve the road's original design vehicle load rating, where no road maintenance (management) obligations exist under the authority of a current or prior permit or licence. This project type is not for de-built roads, which are instead costed under new road construction.

Application

In general, for this project type, the following costs may apply, but are not limited to:

1. geometric design (if applicable);
2. grubbing & stripping (if applicable);
3. fill material:
 - a. development of fill material if required;
 - b. trucking;
 - c. placement; and
 - d. compaction (if required by QRP design);
4. culvert materials if required;
5. subgrade reconstruction;
6. road stabilizing material; and
7. shaping of stabilizing material.

Project Type Combination

NDC projects under this project type are generally stand-alone projects of continuous uninterrupted section of road, road name, and station (start & end) location. If considered for combination with other project types, consult the applicable version of the CAM and Section 2.4 of these procedures.

Eligible Costs

This project type may contain all costs to the top of the stabilized road surface associated with reactivating the road.

Ineligible Costs

Costs that are ineligible for inclusion are bank height tabular road costs, the reason for this is bank height tabular road costs are only applicable for new road construction.

Supporting Information

Geo-referenced photos reflecting road conditions, in both woods and camp direction, that required road reactivation.

Type 10 Road Reconstruction**Description**

This project type is for Road reconstruction, defined as the reestablishment of the road prism to achieve the road's design vehicle load rating, where road maintenance (management) obligations already exist under a permit, as described in the following sub-types:

- A. Reconstruction of wilderness roads and where the road has not had industrial use for at least five years prior to the effective date of the cutting authority; or
- B. Storm damage to the road or drainage structures above required maintenance.

Application

In general, for this project type, the following costs may apply, but are not limited to:

- 1. geometric design (if applicable);
- 2. grubbing & stripping (if applicable);
- 3. fill material:
 - a. development of fill material if required;
 - b. trucking;
 - c. placement; and
 - d. compaction (if required by QRP design);
- 4. culvert materials if required;
- 5. subgrade reconstruction;
- 6. road stabilizing material; and
- 7. shaping of stabilizing material.

Project Type Combination

NDC projects under this project type are generally stand-alone projects of continuous uninterrupted section of road, road name, and station (start & end) location. If considered for combination with other project types, consult the applicable version of the CAM and Section 2.4 of these procedures.

Eligible Costs

This project type may contain all costs associated with construction of the project to the top of the road's stabilized road surface; this may include costs associated with, but not limited to:

1. removal of vegetation from the road prism (that cannot be removed by a grader);
2. re-ditching & culvert cleaning;
3. widening of the road prism;
4. reconstruction of the road prism; and
5. culvert materials.

Ineligible Costs

Costs that are ineligible for inclusion are:

1. project cost(s) if vegetation on the road prism can be removed with a grader, if the removal of vegetation is the only required work;
2. bank height tabular road costs, the reason for this is bank height tabular road costs are only applicable for new road construction.

Supporting Information

1. Documentation that timber extraction/industrial use has not occurred on the road for five years prior to the cutting authority effective date.
2. Geo-referenced photos reflecting road conditions, in both woods and camp direction, that required road reconstruction.

Type 11 Road Upgrade**Description**

This project type is for upgrade of a road due to changes to the road standard or use of the road at the time of original construction. Road Upgrade includes changes to the width of the running surface, horizontal and vertical realignment, lengthening of existing pullouts and adding additional pullouts.

The upgrade of a road may occur for the following reasons:

1. development planning requires that the road access additional timber volumes, with the additional volume or longer haul distance necessitating a change to the physical standard of the road; or
2. safety improvements, which result in a change to the width, horizontal or vertical alignment, and address changes to the volume of industrial traffic using the road, a known documented work safety issue, or changes due to utilization of modern log different truck haul configurations.

Application

A road upgrade must include a reassessment of the design standard. The submitter must receive acceptance in principle of the reassessment from regional appraisal staff prior to submitting the cost in an appraisal.

In general, for this project type, the following costs may apply, but are not limited to:

1. geometric design (if applicable);
2. grubbing & stripping (if applicable);
3. culvert materials (if required by QRP design);
4. subgrade reconstruction;
5. road stabilizing material; and
6. shaping of stabilizing material.

Eligible costs may include additional culverts, larger culverts (when supported by a rationale such as hydrologist report, increased flows, etc.), lengthening or adding pullouts where not required by the road standard or use at the time of original construction, blasting, or road horizontal/vertical realignment.

Project Type Combination

NDC projects under this project type are generally stand-alone projects of continuous uninterrupted section of road, road name, and station (start & end) location. If considered

for combination with other project types, consult the applicable version of the CAM and Section 2.4 of these procedures.

Eligible Costs

This project type may contain all costs associated with construction of the project to the top of the stabilized road surface.

Ineligible Costs

Costs that are ineligible for inclusion are bank height tabular road costs, the reason for this is bank height tabular road costs are only applicable for new road construction.

Supporting Information

A pre-construction geometric design that includes (if applicable): plans, profiles, cross-sections, mass haul and cut and fill volume estimates.

Type 12 Placement of Stabilizing Material**Description**

This project type is for placement of select gravel or broken rock (stabilizing material) on the road subgrade to create a running surface that meets design vehicle load specifications, as described by following sub-types:

- A. Surfacing, as it applies to:
 - 1. roads where the surface material has been lost due to extensive wear and tear; or
 - 2. placement of stabilizing material occurring on an existing road over a continuous and uninterrupted road section length of 0.5 km (500 m) or more, regardless if the road was previously stabilized;
- B. Capping, which only applies to placement of material on new bank height tabular road construction sections because sub-grade material of the road section is:
 - 1. not capable of carrying the design vehicle load; or
 - 2. constructed with material that damages tires of timber extraction equipment;
- C. Where additional stabilizing material is required beyond 3.2 km distance on new bank height tabular road construction section, due to:
 - 1. insufficient suitable material being available for constructing the road sub-grade; and
 - 2. suitable material must be hauled > 3.2 km from the closest source of material to the center point of the receiving bank height tabular road section; then
 - 3. use the "Additional Stabilizing Material >3.2 km Haul Methodology" as described below.

Application

In general, for this project type, the following costs may apply, but are not limited to:

- 1. development of stabilizing material if required;
- 2. loading and transportation of stabilizing material from closest source of suitable material;
- 3. spreading of stabilizing material for sub-type A, and
- 4. shaping of stabilizing material for sub-type A.

Project Type Combination

NDC projects under this project type are generally stand-alone projects of continuous uninterrupted section of road, road name, and station (start and

end) location.

Eligible Costs

This project type may contain all costs associated with the additional stabilizing material project.

Ineligible Costs

Costs that are ineligible for inclusion are:

1. replacement or recovery of gravel that should have been retained on the road surface through normal surface maintenance;
2. recovery of gravel from ditches regardless of the length of road, the reason for this activity is considered maintenance and not replacement of gravel (ditch cleaning and spot gravelling is not eligible where the licensee is responsible for road management under section 5.4 of the CAM);
3. when surfacing (sub-type A), the placement of stabilizing material on an active road section of < 500 metres contiguous length. The reason for this is (where a road section is < 500m length) the surfacing is considered maintenance due to the licensee's responsibility of road management under section 5.4 of the CAM.

Additional Stabilizing Material >3.2 km Haul Methodology

The following methodology is to be used to derive a non - tabular cost estimation for Additional Stabilizing Materials (ASM) hauled > 3.2 km as per section 5.3.4(1)(l) of the Coast Appraisal Manual (CAM) and as referred to in 'Type 12, sub-type (C)' above.

Cost Estimate (\$/km):

$$\text{Cost Estimate (\$/km)} = \mathbf{V \times U}$$

Where:

Volume (V) = 3,000 cubic metres per km

This volume is based upon an average depth of 0.45 metres for "Other Material" bank height categories only. This average depth is for the range of side slopes 0 to >151% and construction categories 1 to 6 inclusive, as per Table Appendix VIII-3 of the CAM as it existed effective March 31, 2019.

Material Unit Cost (\$/U) = $\$0.616 (d - 3.2) / m^3$

d = the actual distance (km) as measured from the center of the Bank Height road section requiring additional stabilizing material to the closest available source of suitable additional stabilizing material.

The submitting forest professional must attach a copy of the 'Additional Stabilizing Material Beyond 3.2 kms' EXCEL form to the appraisal data submission available at the following website: <https://www.for.gov.bc.ca/rco/revenue/> and enter the affiliated ASM information into the 'New Construction' portion of the ECAS40 **Non-Tabular Development Cost** Screen.

Type 13 Retaining Wall Construction**Description**

This project type is for Retaining wall construction due to:

1. the uphill side slope unravelling;
2. road section requirement to ensure subgrade integrity;
3. water scouring around a bridge;
4. slope instability; or
5. other situations discussed and accepted in advance of submission with the Coast Area Pricing appraisal section.

Application

In general, for this project type, the following costs may apply, but are not limited to:

1. purchase cost of structure components;
2. culvert material (if required);
3. transportation (freight) for materials via least expensive route;
4. supply, placement and compaction of foundation (volume as per design);
5. supply, placement and compaction of structural fill (volume and material as per design);
6. labour and equipment costs for installation of structure components;
7. supply and placement of fill for road subgrade (volume as per design);
8. supply and placement of rip rap or scour protection (volumes as per design); and
9. supply and installation of any roadside barriers, hazard markers or required signage.

Project Type Combination

NDC Projects under this project type are generally stand-alone projects of continuous uninterrupted section of road, road name, and station (start & end) location. If considered for combination with other project types, consult the applicable version of the CAM and Section 2.4 of these procedures.

Eligible Costs

This project type may contain all costs associated with construction of the project to the top of the stabilized road surface and culvert material (if required in QRP design for the road section).

Ineligible Costs

Costs that are ineligible for inclusion are bank height tabular road costs.

Supporting Information

1. A QRP's structural design drawings, site plan, and general arrangement documentation for the retaining wall (if applicable).
2. Georeferenced photos.

Type 14 Pipeline Crossing Construction**Description**

This project type is for new road construction required for timber extraction which must cross over an existing pipeline, where a 'pipeline/right-of-way installation permit' or as otherwise applicable a copy of the written agreement (e.g. a memorandum of understanding) with the pipeline client that describes the pipeline client's:

1. engineering standards and practices;
2. design and construction guidelines; and/or
3. ground disturbance pipeline protection requirements.

Application

In general, for this project type, the following costs may apply, but are not limited to:

1. protective material cover method:
 - a. suitable protective cover material costs of:
 - i. processing or obtaining; and
 - ii. transportation;
 - b. equipment and labour costs for:
 - i. excavation of material covering the existing pipe by hydrovac truck and/or hand labour excavation at the pipeline crossing location;
 - ii. installation of suitable protective cover material.
2. clear spanning using a bridge are:
 - a. bridge material cost;
 - b. abutment material cost (i.e. concrete blocks);
 - c. transportation of bridge structural components;
 - d. removal of material covering the pipe using hydrovac truck to locate exact position of the pipe at the pipeline crossing location for:
 - i. labour hand removal costs; and
 - ii. hydrovac;
 - e. equipment and labour costs of installing the bridge.

Project Type Combination

NDC projects under this project type are stand-alone projects of continuous uninterrupted section of road, road name, and station (start & end) location.

Eligible Costs

This project type may contain all costs associated with construction of the project to the top of the stabilized road surface or the bridge deck, and material costs.

Ineligible Costs

Costs that are ineligible for inclusion are bank height tabular road costs, the reason for this is Pipeline Crossing Construction accounts for construction to the top of the stabilized road surface.

Supporting Information

See 'Description' requirements above; and as applicable structural design drawings, site plan, and general arrangement documentation for the project.

Type 15 Powerline Works**Description**

This project type is for increasing an existing powerline height over a road or relocating the line; and allows for new pole(s) be installed to increase the height of the powerline, or to relocate the line above or below ground to meet the minimum clearance distance required by WorkSafeBC.

Application

In general, for this project type, the following costs may apply, but are not limited to:

1. equipment and labour costs for:
 - a. removal of an existing power pole(s); or
 - b. installation of a new power pole(s);
2. cost of pole(s); and
3. installing or moving the powerline.

Project Type Combination

NDC projects under this project type are stand-alone projects as identified by road name, and station (start & end) location.

Eligible Costs

This project type may contain all costs associated with increasing the height of the powerline or relocating the powerline.

Ineligible Costs

Costs that are ineligible for inclusion are any cost not directly associated with increasing the height of, or relocating, the powerline; such as: road construction costs and/or costs associated with interruption of electrical service.

Supporting Information

A rationale describing why the Powerline Works project is required and justified including geo- referenced photos as supporting evidence.

Appendix 1 - Definitions

For Coast Area Appraisal Purposes:

General:

“Applicable CAM Version” means the applicable version of the CAM in effect for the initial appraisal data submission or the post-harvest appraisal data submission;

“Arm’s length” means of or relating to dealings between two parties who are not related or not on close terms and who are presumed to have roughly equal bargaining power; not involving a confidential relationship. An arm’s length transaction does not create fiduciary duties between the parties;

“Drainage Structure” means a bridge or culvert whose purpose is to transfer water from one side of the road to the other side of the road;

“Geometric Design” means the plans, profiles, cross sections and volume calculations by material types for roads and designs for drainage structures;

“Procedures” means the Non-Tabular Development Cost (NDC) Procedures;

“Qualified Registered Professional (QRP)” means, with respect to an activity for which the Coast Appraisal Manual requires a qualified registered professional, a person who:

- a. has appropriate education and experience to carry out the activity, and
- b. is a member of, or licensed by, a regulatory body in British Columbia that has the legislated authority to regulate its members performance of the activity;

“Road Builder Contract” means a signed road builder contract between a road builder and a licensee which specifies payment of new road end haul construction using bank height categories from the CAM plus the invoiced portion of hours stated in the contract for rock truck, excavator, and equipment hours for spoil site management.

“Storm Damage” means a weather event that causes damage to a road or drainage structure due to a significant debris flow or hydraulic scour during a single event, which prevents the passage of vehicles and/or undermines the road’s stability.

Bridges:

“Bridge Abutment or Crib Height” means the average of measurements taken on each end of the bridge measured, to the nearest 0.1 metre, at the mid-point of the bridge deck width, from:

1. bottom contact point with the log stringer (Figure A-5) or girder (Figure A-6) [within “Bridge Span Length” definition], to the
2. ‘original’ ground surface interface which when the bridge design requires:
 - a. compacted leveling material (Figure A-1) is at the bottom crib log or abutment structure;
 - b. structural rock pads (Figure A-2) is at the bottom of the structural rock pad;

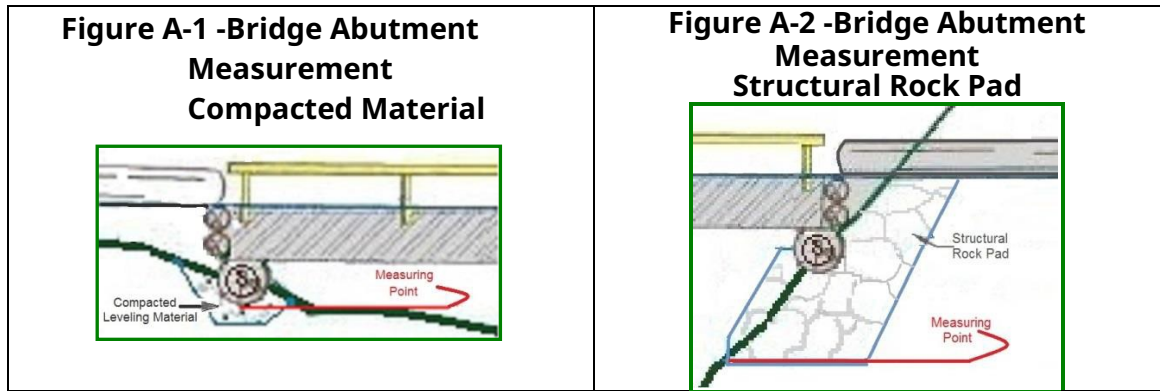

“Bridge Components” means on a permanent/portable bridge and on a log bridge:

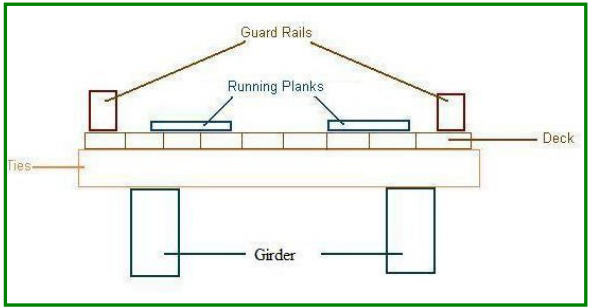
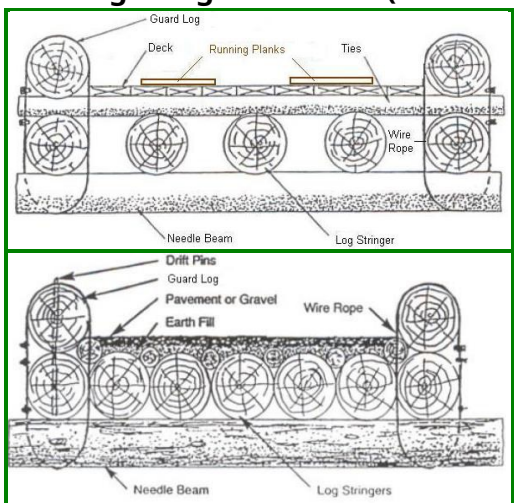
<p>permanent/portable bridge running planks, risers; guard rails, girder(s); ties (cross ties), or deck, or</p> <p>log bridge; running planks, deck, guard log(s) rail(s), ties (cross ties), stringer(s), or needle beam(s).</p>	<p>Figure A-3 – Permanent/Portable Bridge Structure (cross-sectional):</p>  <p>Figure A-4 – Log Bridge Structure (cross-sectional)</p> 
---	--

“Bridge Material” means the various steel, concrete and other components of both the superstructure as well as the substructure. This includes but is not limited to steel girders, steel bracing, treated wood bolts, brackets, concrete deck slabs, packaged grout mix, railings, spacers, signs, no-post precast concrete barriers, precast concrete bulkheads, steel columns, precast concrete footings, etc. that are necessary to achieve certification for industrial use;

“Bridge Substructure” means the portion of the crossing that rests on the foundation and below the superstructure and generally consists of log cribs, interlocking concrete blocks, or steel towers with footings. In some instances, such as interlocking concrete blocks without footings the substructure and foundation are synonymous;

“Bridge Superstructure” means the portion of the crossing that rests on the substructure and provides the traveling surface from the crossing. It generally consists of stringers, deck and guardrails;

“Bridge Span Length” means the measurement to the nearest 0.1 metre and then rounded to the nearest metre (if $\leq 0.45\text{m}$, round down, otherwise round up). The bridge span length for a:

1. log bridge is measured (Figure A-5) from the center of one sill log to the center of the opposite side sill log;

Figure A-5 - Log Bridge Structure

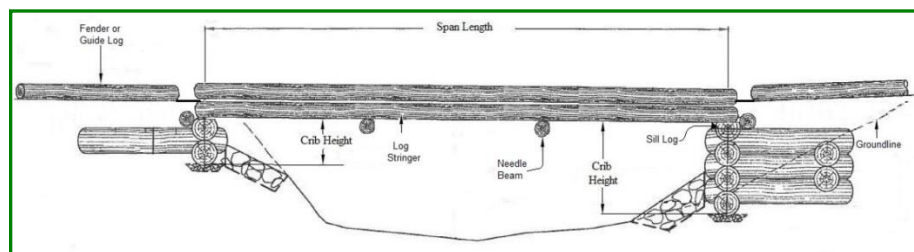

2. Permanent/portable is measured from the edge of one bridge panel (Figure A-6) to the opposite side bridge panel edge.

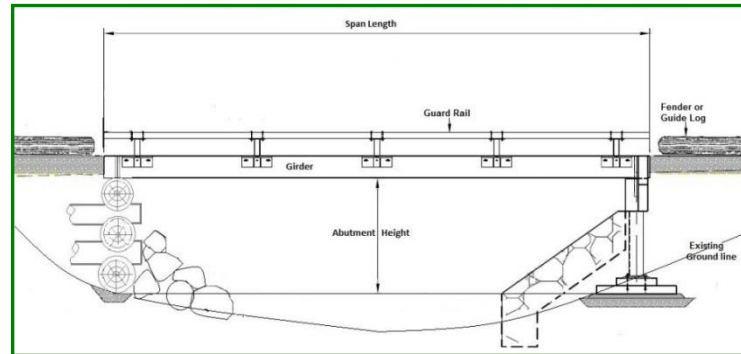
Figure A-6 – Permanent/Portable Bridge Structure

“Bridge Type” means there are log and portable/permanent bridge types. The following is a short list, not limited to, of common bridge types:

All-Steel Portable Bridges: Constructed entirely of steel utilizing both steel box girders and a steel deck. Decks usually come with a coating to allow for traffic-ability.

Composite Bridge: Constructed of steel or concrete girders with steel or concrete decks. Visually, they look much like a non-composite bridge, except that the girders will likely have less cross-sectional area for a given span. In a composite bridge, the deck is continuous with individual panels welded or grouted to each other. In addition, the deck is intimately connected to the girders. Only QRP's are permitted to design composite bridges.

Concrete Slab Girder Bridge: Constructed using reinforced concrete slabs or girders. They are usually solid and rectangular in cross section. Due to problems with cracking and weight, they are usually limited to short spans of ≤ 12 metres.

Log Bridge: Constructed using log stringers on log cribs or a single sill log. Designs usually utilize pre-existing tables developed by a QRP.

Non-composite Bridge: A bridge constructed with steel girders with either timber or concrete decks. In the case of a concrete deck, the deck can be bolted, clipped or grouted to the girders. The deck on a non-composite bridge does not act as a load-sharing member; the vehicle loading is completely supported by the girders.

Permanent Bridge: A bridge structure that has a planned installation period of at least 15 years.

Pre-stressed Concrete Box Girders: Rectangular in cross-section with a hollow rectangular shape in the center. These girders are pre-stressed in a shop and are lighter than concrete slabs of equal span because of the reduced cross-section. These girders can be up to 18 m in length.

Pre-stressed Concrete I-girders: Pre-stressed concrete girders in a similar shape as steel I-beams. A bridge constructed with pre-stressed I-girders is always considered composite. They are used for larger spans and long-term structures.

Portable Bridge: Bridge superstructure designed and fabricated to be re-installed more than once. These may be used in temporary or permanent installations based on planned service life. May include a professionally designed portable bridge to be installed over top of an existing, stable log crib.

Post-tensioned Bridge Components: Post-tensioning is the same principle as pre-stressing. The post-tensioning is usually done in the field, where a series of concrete components are required to be joined together longitudinally. The components are set in place and cables are then inserted through pockets longitudinally and tensioned. Once tensioned, grout is inserted into the pockets and allowed to cure. Once cured, the cables are released of tension and the system has been post-tensioned.

Pre-stressed Bridge Components: For pre-stressed components, the reinforcing steel is put under tension before the concrete is poured. After the concrete is cured, the tension on the steel is released and the tension portion of the concrete is under compression.

Roads:

“Active Road” means a road that the licensee has an obligation to maintain under permit and is currently being used by industrial users;

“As-Built” means field measurements and/or actual machine model/labour type & hours, including material costs of construction for a completed, to design vehicle loads, road section or drainage structure;

“Ballast Material” means the use of gravel, broken rock or other suitable material to construct the road subgrade where other available material is incapable of supporting the design traffic load during the period of use. It provides fill, stable support and running surface for logging related equipment;

“De-Built” means a road that has been deconstructed and/or where the ground is re- contoured and the subgrade has been ripped;

“Fill” means the portion of the road prism where competent suitable material is placed to form the weight bearing road prism;

“Geo-synthetics” means woven and non-woven geo-fabric, geogrid and geo-web products;

“Percent Rock (% rock)” means the amount of rock as compared to the other material including organic layers, glacial till and hardpan, as follows (Figure A-7):

Figure A-7 – Percent Rock

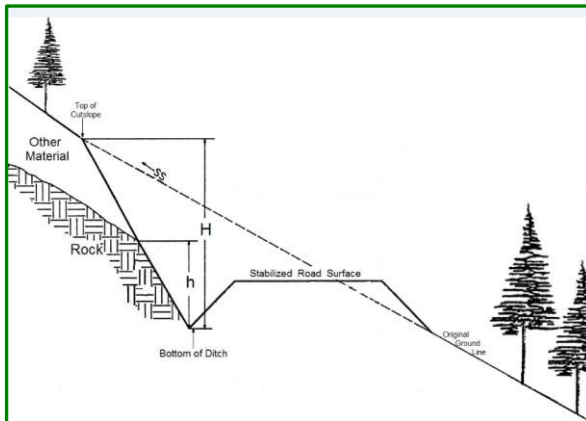

Where:

- h = the vertical cut height of all rock measured from the bottom of the ditch, and
- H = the total vertical cut height of all materials including organic layers, all rock, glacial till and hardpan measured from the bottom of the ditch

$$\% \text{ rock} = \frac{h^2}{H^2} * 100\%$$

“Pit” means the source of suitable material readily available for subgrade construction or stabilizing material;

“Quarry” means the source of material for subgrade construction or stabilizing material that requires drilling and blasting;

“Quarry & Pit Location” means the location of material (haul distance start point) and is identified by the road name and station number (recorded using the station number format 0+000). Alternatively if material is coming directly from an end haul section of road, the end haul road section is considered the location and the center of end haul road section is the start point for measuring haul distance;

“Road Length Measurement” means the measurement generally beginning at the water’s edge (edge of log dump) or at a road intersection with another road. The POC for a constructed road is where the centerline of the constructed road is at the closest edge of the stabilized road width of the other road (Road #1), as per Figure A-8:

Figure A-8 – POC Road Intersection Diagram (when Road #1 is constructed)

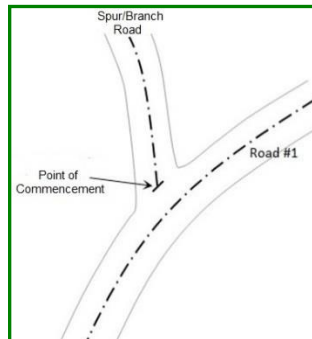

The POC when an unconstructed road junctions off of another unconstructed road is at the intersection of the two centerlines. Road lengths for unconstructed roads are measured by horizontal distance. Road lengths for constructed roads are measured by slope distance;

"Road Right of Way Clearing" means the:

1. falling and bucking (limbing and topping) of standing timber from the road clearing area required for the road right of way including:
 - a. landings;
 - b. turnouts; and
 - c. adjacent to the road right of way:
 - i. borrow pits;
 - ii. quarries; or
 - iii. waste areas;
2. felling of snags and danger trees proximate to the road clearing boundary;
3. grubbing and stripping from the road prism area of:
 - a. stumps;
 - b. roots;
 - c. embedded logs; and
 - d. other debris from the road prism;
4. removal and disposal of organic soils considered unsuitable for constructing a road subgrade; and
5. decking of merchantable logs manufactured from the road clearing area;

“Road Terms and Road Measures” (Figures A-9 and 10) means terms and measures for road sections as follows:

Figure A-9 - Road Terms

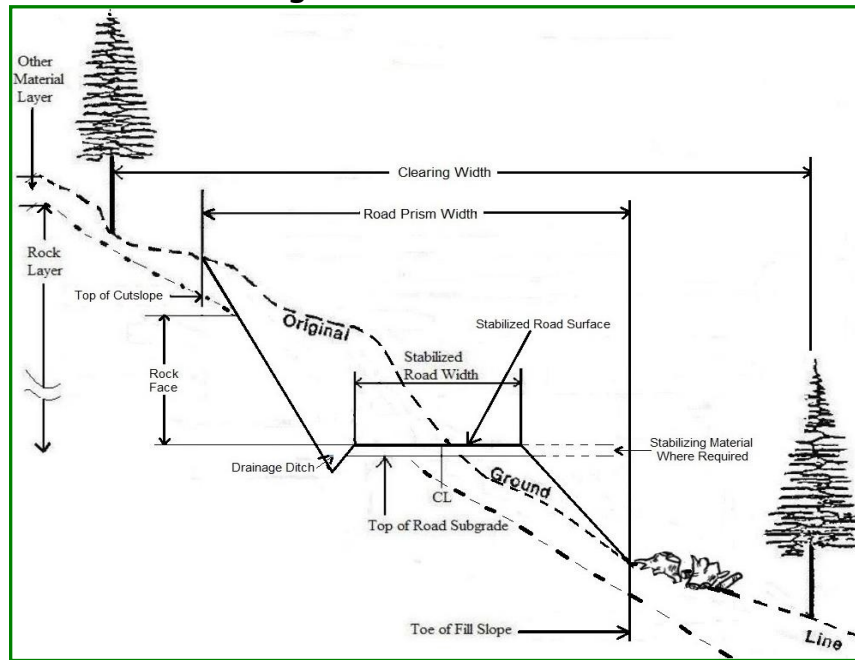
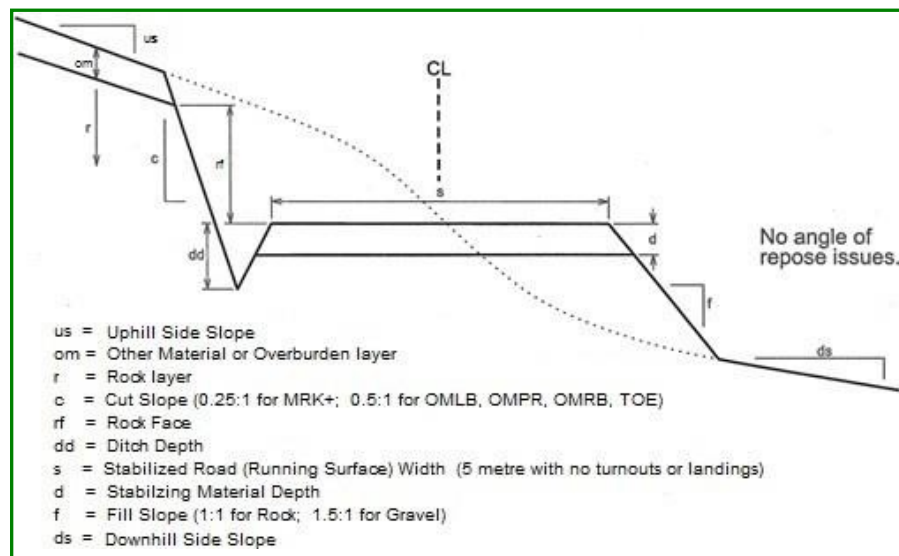

Figure A-10 -Road Measures



Road Prism: Within the road cross-section, at right angles to the road centerline from the top of cut slope to the toe of fill (sidecast), the cuts, fills and road structures.

Subgrade: The layer of the stabilized road composed of parent material resulting from the excavation or movement of material within the road right of way which also possibly forms the stabilized road surface.

Stabilizing Material: Also known as 'surfacing and ballast material' means gravel, broken rock or other suitable material that is placed on the road subgrade to provide fill, stable support and a running surface for industrial use (logging related equipment use). Some stabilizing material may be created during subgrade construction.

Stabilized Road: A road section that is capable of supporting industrial vehicular use and is composed of the subgrade and if required stabilizing material.

Stabilized Road Surface: The surface of a road prism which was created during construction of the sub-grade, or when sub-grade material is un-suitable the placement of additional stabilizing material to create stable support for industrial timber extraction.

Stabilized Road Width: The width of the top surface of the road (measured at right angles to the road centerline from shoulder to shoulder) that provides stable support and surface for industrial related traffic - measured from shoulder to shoulder. For a road class 5, from Engineering Manual circa 1993, is a single lane off-highway road 5 metres in width.

(Average) Stabilized Road Width: (Figure A-11) the average stabilized road width over the whole road (appraised at 6.2 metres) measured at right angles to the road centerline, which includes the stabilized road running surface, widenings, turnouts and landings.

Figure A-11 – Average Stabilized Road Width

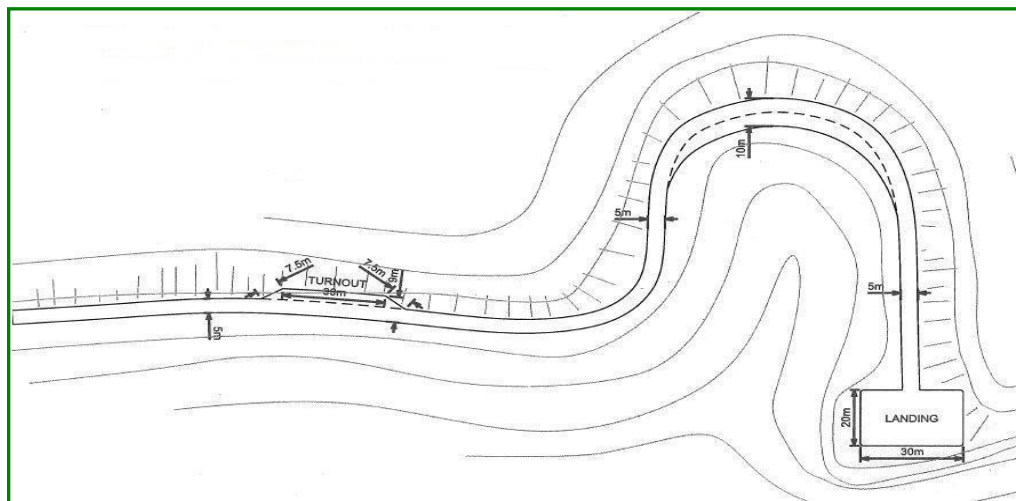

“Select Fill” means fill material that is being used in an application that has certain specifications and is prescribed by a QRP;

“Spoil Site” means the location where end haul material is deposited. This location may be for storage of the material for future use, in construction of a road section or wasting of unsuitable material;

“Stripping” means the removal and disposal of organic material, and mineral soils considered unsuitable for forming the road subgrade;

“Structural Fill” means fill material prescribed by a QRP that is put in place in lifts and compacted.

Appendix 2 - Supervision and Certification Costs**Supervision of Construction:**

The CAM provides for the inclusion of costs related to the supervision by a QRP of the construction of a complex structure.

Structures that qualify (not an exhaustive list) for consideration as complex, are listed below. For an interpretation of whether a structure is considered complex contact regional appraisal staff.

Structures Considered Complex for the Purposes of Inclusion of Costs of Supervision by QRPs in a NDC project(s) in an appraisal:

1. composite concrete bridges;
2. multiple span bridges;
3. major culverts (> 1.8 metres (1800 mm) in diameter or with flows > 6 m³/sec) (Note: density testing of the compacted structural fill must be completed using standardized testing methods; the results of these tests, including testing methodology, must be retained and available for certification; and the extent of structural fill and the specifications (including minimum density requirements) must be shown on the design drawings);
4. non-composite bridges with spans > 25.4 m (bearing to bearing) and/or an abutment height (above ground) > 4.4 m;
5. bridges comprised of pre-stressed and post-tensioned concrete beams and girders;
6. any structure that incorporates a bolted or welded field splice in the girders;
7. any structure placed on piles;
8. complex road structures, limited to road sections that require a QRP's design (Note: this is generally limited to retaining walls, reinforced earth/soil systems, or special construction methods for areas where a TSA is required; generally gravel, or rock berm walls are not considered a retaining wall or complex road structure because these usually do not require a QRP's design); or
9. non-tabular project structures where the services of a QRP are required for the design, supervision and certification of the structure, subject to Section 2.2(6).

Structures which are not considered complex, and are therefore ineligible for inclusion of supervision costs in NDC project(s) in an appraisal:

The list below describes structures which are considered simple structures. The supervision of simple structures is not an allowable cost in an NDC project; regardless of whether the supervision is by a QRP, or non-professional. Therefore, supervision costs of simple structures are not eligible in NDC project(s) in an appraisal.

This does not imply that supervision of simple structures is not required. The distinction between simple and complex structures is made solely to determine eligibility for inclusion of costs for supervision within NDC project(s) in an appraisal.

The list below is not exhaustive. For an interpretation of whether a structure is considered simple, please contact the regional appraisal staff. The following structures are considered simple structures:

1. tabular culverts < 1.8 metres (1800 mm) in diameter;
2. tabular bridges < 25.4 metres in length;
3. non-pre-stressed concrete slab bridges;
4. abutment systems constructed of any of the following:
 - a. lock block walls up to two courses high under the pile cap or girders;
 - b. log cribs \leq 4.4 m in height;
 - c. bin wall structures \leq 1.6 m in height;
 - d. pre-cast concrete footings with steel pipe columns;
5. log, mud sills or concrete sleepers;
6. placement of additional stabilizing on a road subgrade.

Definition of Supervision and Certification Costs:

The CAM allows a cost for a QRP for the supervision of complex structures and the certification/assurance of bridges only.

Supervision of a structure includes the general supervision of the construction for those structures or components that are identified as complex in the list above (**Structures Considered Complex for the Purposes of Inclusion of Costs of Supervision by QRPs in a NDC project(s) in an appraisal**). Visits by a QRP for certification are to verify that those critical aspects of the construction are in general conformance to the design. This would include inspection of subsurface components such as footings, structural fill, bridge components, bridge elevation and alignment, and construction of the bridge.

The supervision of complex structures is not constrained to a maximum number of days, but will be based on the project size, project components and complexity. The number of days allowed for supervision will be for only those portions of the project that requires supervision by a QRP as opposed to general project supervision. If requested by district or regional appraisal staff, the proponent must provide documentation to justify the number of days for supervision or certification.

Bridge Certification:

Certification of bridges, both at the time of fabrication and post-construction, is an eligible NDC item. For bridges which are designed for re-use, this cost would be included on the first installation, as part of the bridge purchase cost and not included on re-use.

The length and number of trips should coincide with the project phases that must be viewed by a QRP to certify the bridge to the design. The certification cost may include additional office time for the completion of the report or record drawings as dictated by the project.

Appendix 3 - References*Engineering Manual*

<https://www2.gov.bc.ca/gov/content/industry/natural-resource-use/resource-roads/engineering-publications-permits/engineering-manual>

Forest Road Engineering Guidebook

https://www2.gov.bc.ca/assets/gov/farming-natural-resources-and-industry/natural-resource-use/resource-roads/forest_road_engineering_guidebook.pdf

Forest Service Bridge Design and Construction Manual

https://www2.gov.bc.ca/assets/gov/farming-natural-resources-and-industry/natural-resource-use/resource-roads/bridge-design-construction/bridge_manual.pdf

Guidelines for Management of Terrain Stability in the Forest Sector

<https://www.egbc.ca/getmedia/b3f36705-fd6f-46ac-b45c-2fdd5d363b9f/APEGBC-Guidelines-for-Management-of-Terrain-Stability-in-the-Forest-Sector.pdf.aspx>

Guidelines for Professional Services in the Forest Sector - Crossings V.2

<https://www.apeg.bc.ca/getmedia/97dcbad3-5482-416a-9bc0-55b3c662e71a/APEGBC-Guidelines-for-Forest-Sector-Crossings.pdf.aspx>

Guidelines for Professional Services in the Forest Sector - Forest Roads

<https://www.apeg.bc.ca/getmedia/b76d39fb-f39c-4939-8bc7-2c48013c4895/APEGBC-Guidelines-Professional-Services-Forest-Roads.pdf.aspx>

Guidelines for Professional Services in the Forest Sector – Terrain Stability Assessments

<https://www.egbc.ca/getmedia/684901d7-779e-41dc-8225-05b024beae4f/APEGBC-Guidelines-for-Terrain-Stability-Assessments.pdf.aspx>

Land Management Handbook Number 18 - A Guide for Management of Landslide-Prone Terrain in the Pacific Northwest

<https://www.for.gov.bc.ca/hfd/pubs/docs/lmh/Lmh18.pdf>

Appendix 4 - New NDC Form

Submitting forest professionals can find the current version of the EXCEL form for 'Non-Tabular Development Cost Form' at the following website: <https://www.for.gov.bc.ca/rco/revenue/>

Appendix 5 - NDC Procedures – Equipment Stand-By Time**Stand-by Definition**

1. “Stand-by time” or “stand-by” means the amount of time that equipment is at an active NDC project worksite while the equipment is: (a) shutdown; (b) physically located at the NDC project work site; and (c) required at the NDC project worksite to complete upcoming work on the project.

Eligible Equipment

2. Only stand-by time associated with the following types of equipment is appraisable:
 - a. excavators (e.g. mini/compact, wheeled, or heavy hydraulic);
 - b. tractors (e.g. bulldozer, rubber tired, or backhoes);
 - c. rock drill machines (e.g. tracked drills, tank drills, or heavy hydraulic excavators);
 - d. grader machines (in use for road construction only);
 - e. heavy lifting machines (e.g. cranes, or flat deck trucks with crane attachment);
 - f. roller or compactor machines (self propelled ride-on only);
 - g. loader machines;
 - h. dump trucks;
 - i. off-highway heavy duty dump trucks (e.g. rock trucks);
 - j. concrete pumper trucks;
 - k. manlifts / aerial platform machines; and
 - l. low bed trucks.

Ineligible Equipment

3. Any other equipment is ineligible for stand-by in an appraisal.

Eligible / Ineligible Hours

4. Appraised stand-by must not include time associated with delays due to: (a) work schedules, (b) weather conditions; (c) acts of God; (d) equipment breakdown; and or (e) other equipment, labour, or systems breakdown affecting productivity.
5. Appraised stand-by must not include time before an equipment’s first or last active use on the NDC project.
6. Appraised stand-by must not include time associated with bank height category road construction.
7. Appraised stand-by time must not include time associated with a full stoppage of work; except, equipment may be considered on stand-by time when the work site is temporarily shutdown and crew are away for the purpose of picking up related blasting

materials from a local powder magazine (located on or near the worksite) and/or conducting a related blast.

8. Drilling equipment is considered on stand-by time while the operator is loading blast material unless its compressor is being used to blow blasting agents into the boreholes.
9. A piece of equipment cannot be on stand-by for multiple NDC projects simultaneously.
10. Appraised stand-by time for a single piece of equipment must not exceed eight (8) hours a day.

Methodology for Detailed Calculation

11. The appraised stand-by rate for **equipment** is half the equipment's "less operator" rate provided in the bluebook (including attachments if applicable); where a blue book rate is not available then use the invoiced stand-by rate. Fuel Cost Adjustment(s) must not be added to the appraised stand-by rate.
12. The appraised stand-by rate for an **equipment operator** is the difference between the "all found" rate and the "less operator" rate provided in the bluebook; where a blue book rate is not available then use the equipment operator's invoiced rate. The equipment operator is not considered on stand-by unless the equipment operator must be on stand-by and is required to stand-by with the equipment.

Documentation for Detailed Calculation

13. If the NDC project is completed under road construction contract then the appraised stand-by time must be supported by the invoice document(s), and timecard document(s).
14. If the NDC project is completed by employee(s) of the licensee then the appraised stand-by time must be supported by timecard document(s).