

---

**Tree Farm Licence 48  
Vegetation Resources Inventory  
Statistical Adjustment**

Prepared for  
*Don Rosen*  
*Canadian Forest Products Ltd.*  
*Chetwynd, BC*

Project: CFC-007

March 31, 2003



**J.S. Thrower & Associates Ltd.** Consulting Foresters  
Vancouver – Kamloops, BC



## Executive Summary

Canadian Forest Products Ltd. is implementing a Vegetation Resources Inventory (VRI) for Tree Farm Licence (TFL) 48. The Phase I (unadjusted inventory data) and Phase II (ground plot data) are now complete. This report describes the inventory statistics for this project.

The target population for VRI statistical adjustment was the TFL Vegetated Treed areas  $\geq 30$  years. Following statistical adjustment, site index increased 8% and net merchantable volume increased approximately 30%. In high and moderate priority areas (321,065 ha), net merchantable volume increased approximately 18%. Adjusted volume estimates were not corrected for taper and hidden decay bias with Net Volume Adjustment Factor (NVAF) sampling. Therefore, the volume increase is slightly overstated.

The management impacts of these inventory changes are:

- The overall upward adjustment of approximately 18% for standing volume in the high and moderate priority areas may increase the future allowable annual cut for the TFL.
- There may be an increase in the land base classified as VT moderate priority if the adjusted database is re-classified by land type.



**Table of Contents**

<b>1. INTRODUCTION.....</b>	<b>1</b>
1.1 BACKGROUND .....	1
1.2 PROJECT OBJECTIVES .....	2
1.3 REPORT OBJECTIVES .....	2
1.4 TERMS OF REFERENCE.....	2
<b>2. VRI DATA .....</b>	<b>3</b>
2.1 LAND BASE .....	3
2.2 PHASE I (UNADJUSTED INVENTORY DATA) .....	3
2.3 PHASE II (GROUND PLOT DATA).....	5
<b>3. METHODS .....</b>	<b>6</b>
3.1 NET VOLUME ADJUSTMENT FACTOR SAMPLING .....	6
3.2 STATISTICAL ADJUSTMENT.....	6
3.3 POST-STRATIFICATION.....	6
3.4 ADJUSTMENT FACTORS .....	6
<b>4. RESULTS.....</b>	<b>8</b>
4.1 HEIGHT AND AGE ADJUSTMENT.....	8
4.2 ATTRIBUTE-ADJUSTED VOLUME ADJUSTMENT.....	9
4.3 ADJUSTED INVENTORY.....	11
<b>5. DISCUSSION .....</b>	<b>12</b>
5.1 COMPARISON WITH 1998 INVENTORY AUDIT.....	12
5.2 IMPACT OF VOLUME INCREASE .....	12
5.3 IMPACT OF SITE INDEX INCREASE .....	12
<b>6. CONCLUSIONS.....</b>	<b>13</b>
<b>APPENDIX I - PHASE II GROUND SAMPLING .....</b>	<b>14</b>

### List of Tables

Table 1. TFL 48 net down statistics.....	3
Table 2. Unadjusted inventory statistics (VT ≥ 30 years). ....	3
Table 3. Sampling weights (VT ≥ 30 years).....	5
Table 4. Phase II ground sampling volume statistics (VT ≥ 30 years).....	5
Table 5. Phase II ground sampling height and age statistics (VT ≥ 30 years).....	5
Table 6. Height and age adjustment statistics (VT ≥ 30 years). ....	8
Table 7. Attribute-adjusted volume (VT ≥ 30 years).....	9
Table 8. Volume adjustment statistics (VT areas ≥ 30 years). ....	10
Table 9. Unadjusted and adjusted inventory statistics for height, age, & site index (VT ≥ 30 years).....	11
Table 10. Unadjusted and adjusted inventory statistics for volume (VT ≥ 30 years). ....	11
Table 11. Distribution of Phase II plots by project and plot type in TFL 48.....	14
Table 12. Distribution of Phase II plots in the TFL 48.....	14

### List of Figures

Figure 1. VRI program.....	1
Figure 2. TFL 48 location. ....	4
Figure 3. Adjustment overview. <sup>6</sup> .....	7
Figure 4. Ground vs. unadjusted inventory height (stocking class 0). ....	8
Figure 5. Ground vs. unadjusted inventory height (non-0 stocking classes). ....	8
Figure 6. Ground vs. unadjusted inventory age (non-0 stocking class).....	9
Figure 7. Ground vs. unadjusted inventory age (stocking class 0). ....	9
Figure 8. Ground vs. attribute-adjusted volume 12.5 cm (VT High priority areas).....	10
Figure 9. Ground vs. attribute-adjusted volume 12.5 cm (VT Moderate & Low priority areas). ....	10
Figure 10. Ground vs. attribute-adjusted volume 17.5 cm (VT High priority areas).....	10
Figure 11. Ground vs. attribute-adjusted volume 17.5 cm (VT Moderate & Low priority areas). ....	10

## 1. INTRODUCTION

### 1.1 BACKGROUND

Canadian Forest Products Ltd. (Canfor) Tree Farm Licence (TFL) 48 is located in the Dawson Creek Forest District of the Prince George Forest Region. The TFL consists of five supply blocks and the Rice Property. Canfor is developing a new forest inventory for these areas using the provincial Vegetation Resources Inventory (VRI) process. The intent is to provide improved forest cover estimates into the timber supply analysis, and support the new Terrestrial Ecosystem Map (TEM) and site index inventory for the TFL.

The provincial VRI is a four-phase process (Figure 1) and consists of the following steps:

1. Phase I (unadjusted inventory data) – new forest cover polygon boundaries and attributes are delineated using aerial photography.
2. Phase II (ground plot data) – tree measurements are taken from randomly located timber emphasis plots (TEPs).
3. Net Volume Adjustment Factor (NVAF) sampling – trees are randomly selected for stem-analysis to develop adjustment ratios that correct for taper and decay estimation bias.
4. Statistical Adjustment Phase – Phase I estimates are adjusted using the NVAF-corrected TEPs to provide an adjusted unbiased estimate of forest inventory attributes. The final product is the adjusted VRI database.

To date, Canfor has completed the Phase I and II programs on the TFL. In Phase I, the attributes of all forest cover polygons were estimated using 1993/94 and 1997 aerial photography. In Phase II, Canfor installed 154 TEPs in three separate projects. Initially, 65 TEPs were established in 1998 to audit the existing mature inventory, and then 72 TEPs were installed in 2001 and 2002. The Ministry of Forests (MOF) augmented the inventory by establishing 10 TEPs in 1998 and seven in 1999.

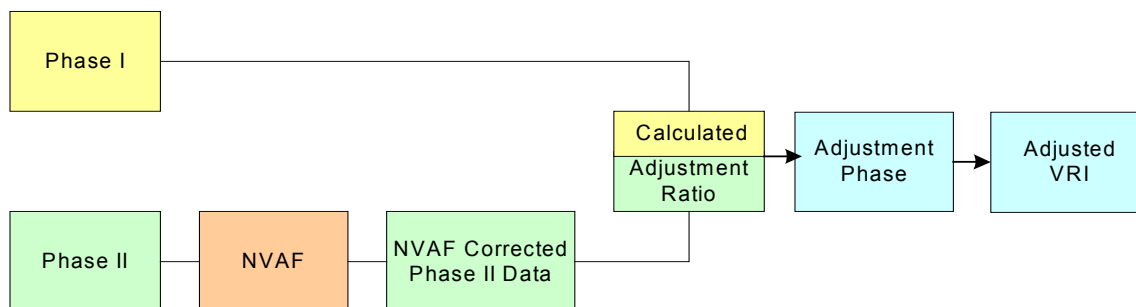

Figure 1. VRI program.

## 1.2 PROJECT OBJECTIVES

The main objectives of the Phase II (ground plot data) were to:<sup>1</sup>

1. Install an adequate number of TEPs to adjust the Phase I inventory with a sampling error of  $\pm 10\%$  (95% probability) for net merchantable volume in high and moderate priority areas.<sup>2</sup>
2. Provide baseline ecology and coarse-woody debris data to support other projects in the TFL including TEM, Site Index Adjustment (SIA), monitoring, and certification.

A 95% sampling error of  $\pm 10\%$  for the adjusted net merchantable volume would meet Ministry of Sustainable Resource Management (MSRM) standards for Timber Supply Review.

## 1.3 REPORT OBJECTIVES

The objectives of this report were to:

1. Provide statistics for the Phase I (unadjusted inventory data)
2. Provide statistics for the Phase II (ground plot data)
3. Adjust the Phase I inventory target population
4. Provide statistics for the adjusted inventory.

## 1.4 TERMS OF REFERENCE

J.S. Thrower & Associates Ltd completed this TFL 48 VRI statistical adjustment for Canfor. Don Rosen of Canfor, Chetwynd Division was the project leader. The JST team included Guillaume Thérien, *PhD* (project manager) and A.Y. Omule, *PhD, RPF* (report writer).

---

<sup>1</sup> JS Thrower & Associates Ltd. 2000. Canfor TFL 48 vegetation resources inventory sampling plan. Unpublished report, Project No. CFC-012-002. 20 pp.

<sup>2</sup> High, moderate, and low priority areas are defined in Section 2.1.



## 2. VRI DATA

### 2.1 LAND BASE

The total area of TFL 48 is 643,487 ha, of which 561,858 ha (87%) is Vegetated Treed (VT). The remaining landbase includes Vegetated Non-Treed (VN) and Non-Vegetated (NV) areas (Table 1, Figure 2).

The VT land base is divided into three priority classes based on inventory site index and age. High priority areas are at least 80 years with a minimum site index of 8 m (spruce), 11 m (balsam and pine), 14 m (aspen), and 7 m (cottonwood). The moderate priority areas are less than 80 years with the same minimum site indices as the high priority areas. The low priority area is the remainder of the VT land base. The high and moderate priority areas will likely be included in the next timber supply analysis.

Table 1. TFL 48 net down statistics.

Land Type	Area	
	(ha)	(%)
Vegetated Treed ( $\geq$ 30 years)	538,059	84
High priority	269,069	50
Moderate priority	51,996	10
Low Priority	216,993	40
Vegetated Treed (<30 years)	23,799	3
High priority	0	0
Moderate priority	22,124	93
Low priority	1,675	7
Vegetated Non-Treed & Non-Vegetated	81,629	13
<i>Total TFL</i>	<i>643,487</i>	<i>100</i>

The areas provided in Table 1 differ slightly from those provide in the sampling plan.<sup>1</sup> The reason for this is the original sampling plan did not net out private land and woodlots, and included records from the VRI LAYER table where "FOR\_COVER\_RANK\_CD = NULL" instead of "FOR\_COVER\_RANK\_CD = 1".

The entire TFL (643,487 ha) was sampled for this project, but only the VT polygons with an age  $\geq$  30 years were adjusted (538,059 ha, 84% of the total area), as recommended by the MSRM. Unadjusted values will be used for polygons less than 30 years.

### 2.2 PHASE I (UNADJUSTED INVENTORY DATA)

In the unadjusted inventory, the average stand height was 18.6 m, stand age 130 years, and site index 11 m (Table 2). The average unadjusted volume<sup>3</sup> was 162 m<sup>3</sup>/ha and 145 m<sup>3</sup>/ha for the 12.5 cm and 17.5 cm utilization levels (Table 2).

Table 2. Unadjusted inventory statistics (VT  $\geq$  30 years).

Land Type Priority	Area (ha)	Height (m)	Age (yrs)	Site Index (m)	Volume (m <sup>3</sup> /ha)	
					12.5 cm	17.5 cm
VT High	269,069	23.0	128.5	14.0	228.8	211.4
VT Moderate	51,996	13.4	52.2	15.4	63.1	42.2
VT Low	216,993	14.4	150.3	7.0	102.4	86.0
<i>Total</i>	<i>538,059</i>	<i>18.6</i>	<i>129.9</i>	<i>11.3</i>	<i>161.8</i>	<i>144.5</i>

<sup>3</sup> Inventory volume in this report is net merchantable volume.

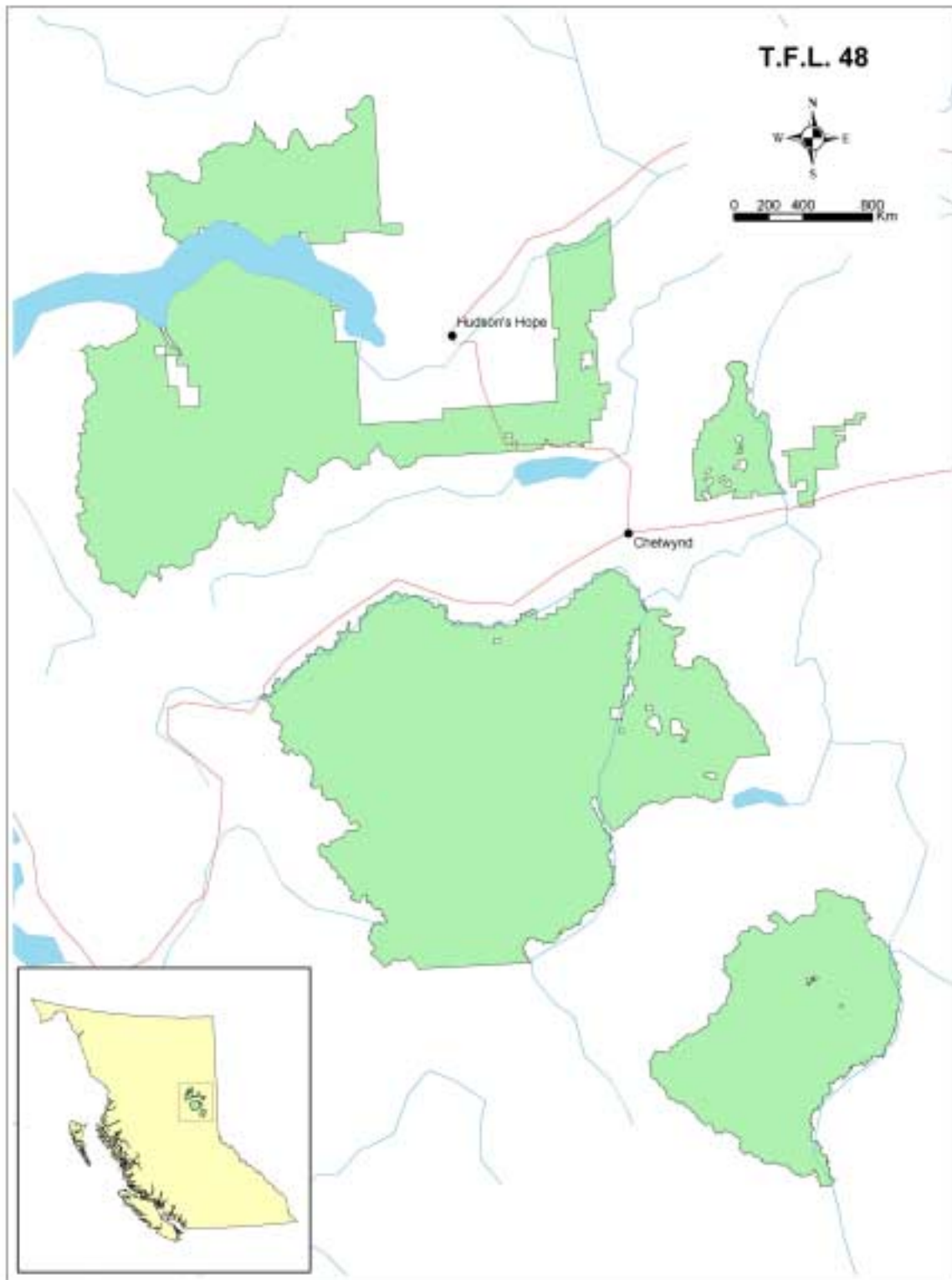

Figure 2. TFL 48 location.

### 2.3 PHASE II (GROUND PLOT DATA)

A total of 154 TEPs were established on the TFL (Appendix I), however only 137 were used in the analysis. Seven plots are in areas < 30 years and 10 located in VN and NV areas were not used in the analysis. Sample weights, calculated on an absolute and relative basis, were the number of hectares represented by each plot (Table 3). Relative weights were used in the calculation of height, age, and volume statistics and adjustment factors.

Ground sampling statistics included averages and 95% probability confidence intervals (95% CI) for height, age, and volume.<sup>4</sup> Overall average volume was 234 m<sup>3</sup>/ha (12.5 cm) and 215 m<sup>3</sup>/ha (17.5 cm) (Table 4). Average height was approximately 21 m and average age was 117 years (Table 5).

Table 3. Sampling weights (VT ≥ 30 years).

Land Type Priority	Area (ha)	Sample Size	Sample Weight	
			Absolute	Relative
VT High	269,069	91	2,957	1.308
VT Moderate	51,996	23	2,261	1.000
VT Low	216,993	23	9,435	4.173
<i>Total</i>	<i>538,059</i>	<i>137</i>		

Table 4. Phase II ground sampling volume statistics (VT ≥ 30 years).

Land Type Priority	Sample Size	Volume (12.5 cm)		Volume (17.5 cm)	
		Avg (m <sup>3</sup> /ha)	95% CI (m <sup>3</sup> /ha)	Avg (m <sup>3</sup> /ha)	95% CI (m <sup>3</sup> /ha)
VT High	91	280.6	256.3, 305.0	267.4	241.9, 292.8
VT Moderate	23	103.7	63.5, 143.8	66.9	32.3, 101.5
VT Low	23	181.0	126.6, 235.4	154.0	97.8, 210.2
<i>Total</i>	<i>137</i>	<i>234.2</i>	<i>211.6, 256.8</i>	<i>214.7</i>	<i>190.9, 238.5</i>

Table 5. Phase II ground sampling height and age statistics (VT ≥ 30 years).

Land Type Priority	Sample Size	Height		Age		
		Avg. (m)	95% CI (m)	Sample Size	Avg. (yrs)	95% CI (yrs)
VT High	77	23.8	22.7, 24.9	79	125.2	117.2, 133.3
VT Moderate	18	14.6	12.0, 17.1	18	67.6	54.1, 81.1
VT Low	21	16.9	14.5, 19.4	23	128.0	102.5, 153.5
<i>Total</i>	<i>116</i>	<i>21.1</i>	<i>20.0, 22.3</i>	<i>120</i>	<i>117.1</i>	<i>109.0, 125.3</i>

<sup>4</sup> Ground volume in this report is whole-stem volume less top, stump, cruiser-called decay, waste, and breakage. Cruiser-called decay was not NVAF corrected.

### 3. METHODS

#### 3.1 NET VOLUME ADJUSTMENT FACTOR SAMPLING

The NVAF sampling was not included in Phase II, therefore net volume was approximated using a correction factor of 1.0, which was used in the report calculations.<sup>5</sup> As of April 2002, NVAF sampling is part of the new MSRM VRI standard. Until then, the VRI database is not fully compliant.

#### 3.2 STATISTICAL ADJUSTMENT

The statistical adjustment used in this report followed MSRM procedures for attribute adjustment.<sup>6</sup> The MSRM adjustment process assumes that the unadjusted (Phase I) inventory volume is biased due to two sources of error:

1. An attribute bias associated with the photo-interpreted height and age.
2. A model bias inherent to the growth and yield model used to estimate volume (*VDYP vers. 6.6d*).

This process assumes that the errors from other attributes used by *VDYP* (species composition, stocking class, and crown closure) have a marginal impact on volume.

The attribute adjustment procedure is a two-step process (Figure 3) and described as follows:

1. In the first step, the Phase I height and age biases are corrected using an adjustment ratio calculated from the Phase I and Phase II ground data. An attribute-adjusted volume can then be estimated using *VDYP* with the adjusted height and age.
2. In the second step, an adjustment ratio estimated from the attribute-adjusted volume and the Phase II volume is calculated, and this ratio is used to correct the model bias in the attribute-adjusted volume.

#### 3.3 POST-STRATIFICATION

Post-stratification<sup>7</sup> was explored to improve the precision of the estimated adjustment ratios for height, age, and attribute-adjusted volume. The post-stratification variables included leading species, biogeoclimatic (BGC) zone, stocking class, land type, age, crown closure, age, height, and site index. For height and age attributes, species stratification was also tested, while volume stratification was tested at two utilization levels (12.5 cm and 17.5 cm).

#### 3.4 ADJUSTMENT FACTORS

The usual ratio of means (ROM) statistical method was used to derive adjustment factors for all three adjusted attributes; height, age, and attribute-adjusted volume. The observations were weighted appropriately since the sample selection probabilities were unequal among the land types. Phase I photo-interpreted height and age were projected to January 2000. The Phase II height and age were mean total height and mean total age of the leading-species, site and top-height trees. The ROM of Phase II to Phase I values was the adjustment factor for height and age.

---

<sup>5</sup> Will Smith (Volume and Decay Sampling Officer, MSRM), personal communication, November 27, 2002.

<sup>6</sup> Ministry of Sustainable Resource Management. 2002. Vegetation resources inventory attribute adjustment procedures. 37 pp.

<sup>7</sup> Post-stratification is when stratification occurs after the field sampling.

The attribute-adjusted volume was then generated with *VDYP* (version 6.6d) using the adjusted height and age. The ROM of Phase II volume to attribute-adjusted volume is the attribute-adjusted volume adjustment factor. The volume adjustment factors were calculated at two utilization levels: 12.5 cm and 17.5 cm.

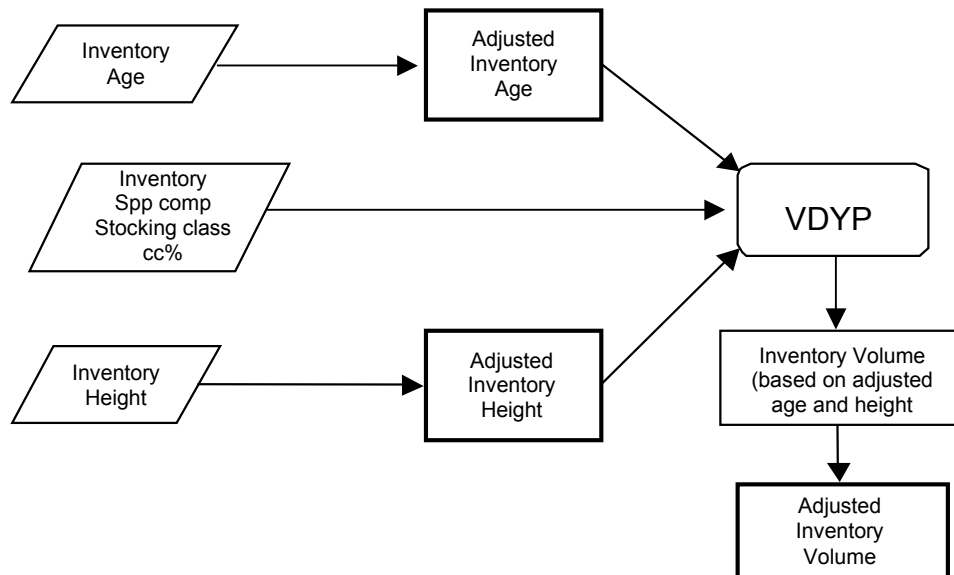

Figure 3. Adjustment overview.<sup>6</sup>

## 4. RESULTS

### 4.1 HEIGHT AND AGE ADJUSTMENT

Post-stratification was not beneficial to the height and age adjustment for all the attributes tested except for stocking class. Therefore, two adjustment equations were developed for height and age, stratified by stocking class 0 and non-0 stocking class (Table 6 and Figures 4 to 7).

Adjusted population height increased approximately 1.7 m (11%) compared to unadjusted height for stocking class 0, and did not change for the combined non-0 stocking classes (Table 6). Adjusted population age increased approximately nine years (11%) compared to unadjusted age for stocking class 0, and decreased approximately 21 years (16%) for the combined non-0 stocking classes (Table 6). The sampling errors for the height and age adjustment ratios for both stocking class groups were less than 10% (95% probability).

Table 6. Height and age adjustment statistics (VT  $\geq$  30 years).

Attribute/ Stocking Class (SC)	Population		Sample					Adj. Pop.		
	Area (ha)	Unadj. Avg.	Size	Grnd. Avg.	Unadj. Avg.	R <sup>2</sup>	ROM	Avg.	95% CI	E %
Height (m)										
SC 0	158,582	13.7	31	17.7	15.8	52%	1.122	15.4	13.9, 16.8	9.4
Non-0 SC	379,477	20.7	85	20.7	20.4	42%	1.011	20.9	19.7, 22.1	5.6
Age (yrs)										
SC 0	158,582	76.1	33	90.3	80.4	50%	1.123	85.4	77.5, 93.4	9.3
Non-0 SC	379,477	152.4	87	130.9	152.0	24%	0.861	131.3	119.2, 143.4	9.2

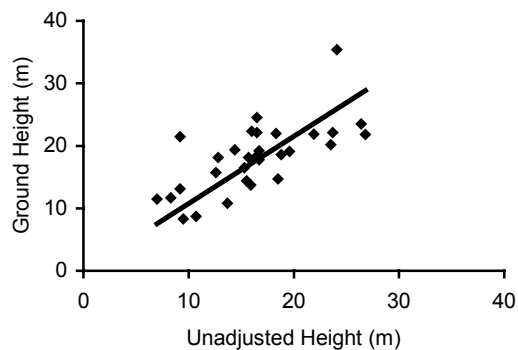

Figure 4. Ground vs. unadjusted inventory height (stocking class 0).

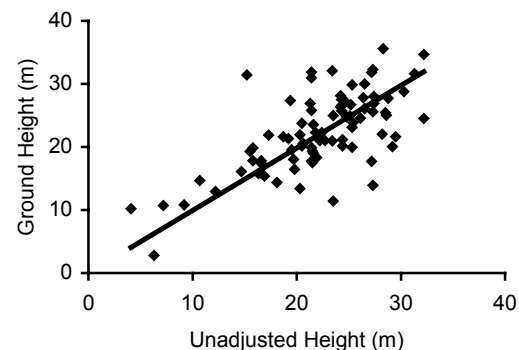

Figure 5. Ground vs. unadjusted inventory height (non-0 stocking classes).

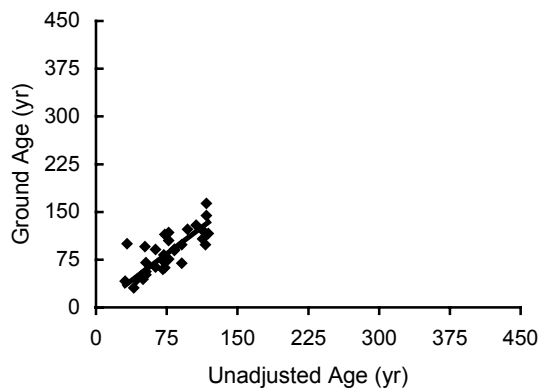

Figure 6. Ground vs. unadjusted inventory age (stocking class 0).

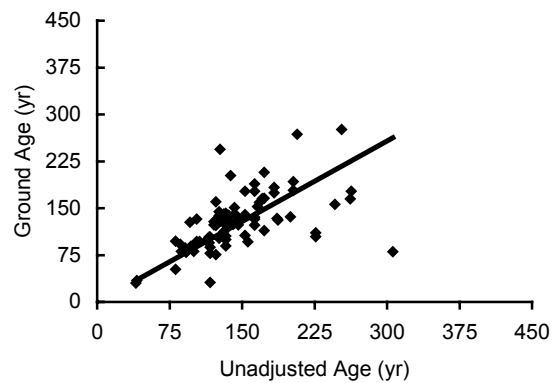

Figure 7. Ground vs. unadjusted inventory age (non-0 stocking class).

#### 4.2 ATTRIBUTE-ADJUSTED VOLUME ADJUSTMENT

Post-stratification was not beneficial for attribute-adjusted volume for all the variables tested. However, adjustment ratios were developed and applied separately for the VT high priority areas and for the remaining VT areas. This separation ensured a more precise adjustment in the high priority areas.

Compared to the unadjusted VDYP volume, the attribute-adjusted volume increased approximately 5% for both 12.5 cm and 17.5 cm utilization levels (Table 7).

Table 7. Attribute-adjusted volume (VT  $\geq$  30 years).

Land Type Priority	Utilization Level (cm)	Unadjusted Volume (m <sup>3</sup> /ha)	Attribute-Adjusted Volume (m <sup>3</sup> /ha)	Difference (%)
VT High	12.5	228.8	236.8	3
	17.5	211.4	218.0	3
VT Moderate	12.5	63.1	86.5	37
	17.5	42.2	63.2	50
VT Low	12.5	102.4	108.7	6
	17.5	86.0	91.1	6
<i>Total</i>	12.5	161.8	170.6	5
	17.5	144.5	151.9	5

After adjustment, the overall attribute-adjusted volume increased approximately 23% (171 to 210 m<sup>3</sup>/ha) and 26% (152 to 191 m<sup>3</sup>/ha) for the 12.5 cm and 17.5 cm utilization levels (Table 8, Figures 8 to 11). These numbers reflect the weighted average numbers presented in the table.

Table 8. Volume adjustment statistics (VT areas ≥ 30 years).

Land type/ Utilization level	Population		Sample				Adj. Pop.			E %
	Area (ha)	Avg. volume* (m <sup>3</sup> /ha)	Size	Grnd. Avg. (m <sup>3</sup> /ha)	Avg. volume* (m <sup>3</sup> /ha)	R <sup>2</sup>	ROM	Avg. volume (m <sup>3</sup> /ha)	95% CI (m <sup>3</sup> /ha)	
<i>High priority:</i>										
12.5 cm	269,069	236.8	91	280.6	253.4	18%	1.108	262.3	240.1, 284.5	8.5
17.5 cm	269,069	218.0	91	267.4	234.9	20%	1.138	248.2	225.3, 271.1	9.2
<i>Moderate &amp; Low priority:</i>										
12.5 cm	268,990	104.4	46	166.1	109.6	31%	1.515	158.2	125.0, 191.3	21.0
17.5 cm	268,990	85.7	46	137.1	87.7	29%	1.565	134.1	100.0, 168.1	25.4

\* Attribute-adjusted volume.

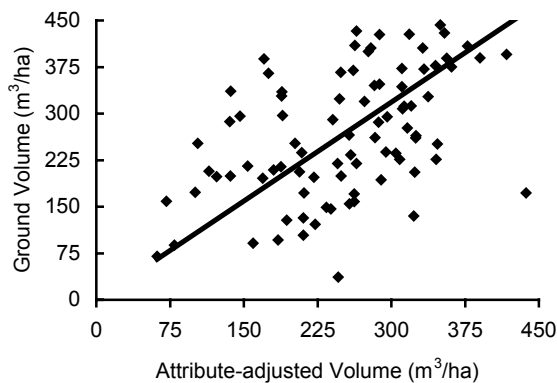

Figure 8. Ground vs. attribute-adjusted volume 12.5 cm (VT High priority areas).

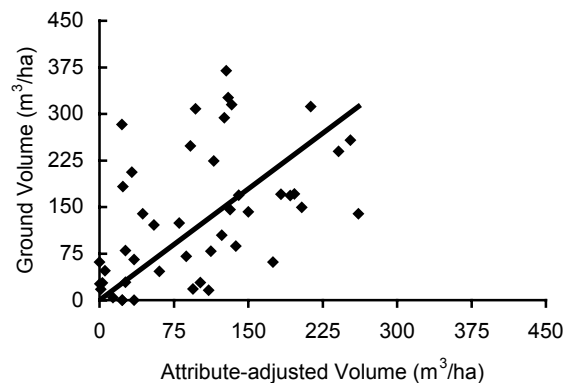

Figure 9. Ground vs. attribute-adjusted volume 12.5 cm (VT Moderate & Low priority areas).

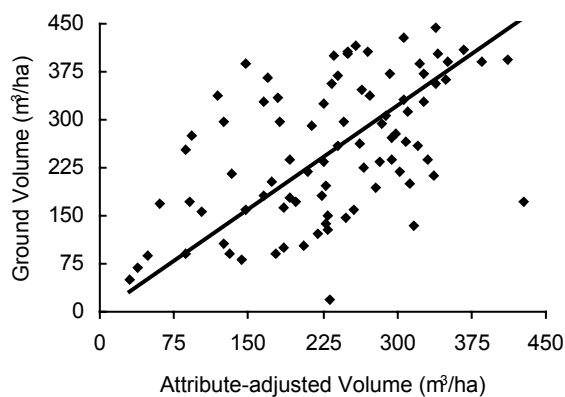

Figure 10. Ground vs. attribute-adjusted volume 17.5 cm (VT High priority areas).

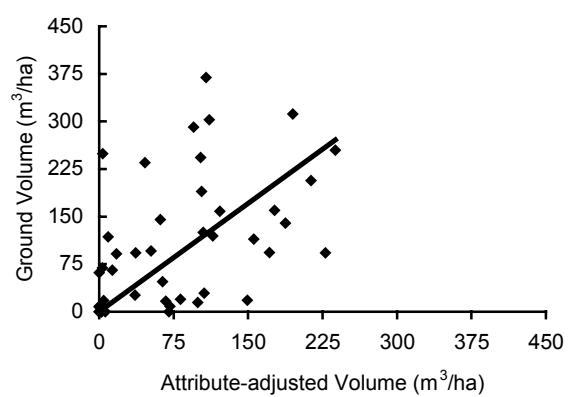

Figure 11. Ground vs. attribute-adjusted volume 17.5 cm (VT Moderate & Low priority areas).

The targeted sampling error of ±10% (95% probability) for the high and moderate priority areas (Section 1.2) was achieved. The sampling errors were approximately 9% for the high priority area and 21-25% for the moderate and low priority areas. If we combine the high and moderate areas, the sampling errors



were 7.9% (12.5 cm level) and 8.7% (17.5 cm level). The sampling errors for the total adjusted land base were 9.4% (12.5 cm level) and 10.6% (17.5 cm level).

The interpretation of the sampling error is (e.g., for 12.5 cm level, high priority areas):

1. If we repeated the same sampling procedure numerous times using the same sample size and sampling methodology, the true unknown average volume would be within 8.5% of the estimate average 19 times out of 20.
2. With the unique sample available, one can be 95% certain that the adjusted average volume (262.3 m<sup>3</sup>/ha) (Table 10) is within 8.5% of the true volume; however, there is a 5% chance that the estimated volume is not within 10% of the true volume.

### 4.3 ADJUSTED INVENTORY

Following adjustment, the overall age of the leading species decreased approximately 9%, and the overall height and site index of the leading species increased approximately 4% and 8%, respectively, compared to corresponding unadjusted values (Table 9).

Table 9. Unadjusted and adjusted inventory statistics for height, age, & site index (VT ≥ 30 years).

Land Type Priority	Area (ha)	Unadjusted Inventory			Adjusted Inventory			Difference (%)		
		Age (yrs)	Site Index (m)	Height (m)	Age (yrs)	Site Index (m)	Height (m)	Age	Site Index	Height
VT High	257,383	129.3	13.9	22.9	114.9	15.2	23.7	-11	+9	+3
VT Moderate	50,211	52.2	15.4	13.3	57.7	15.5	14.9	+10	+1	+12
VT Low	230,464	147.6	7.6	15.0	135.7	8.3	14.9	-8	+10	+0
<i>Total</i>	<i>548,059</i>	<i>129.9</i>	<i>11.3</i>	<i>18.6</i>	<i>117.8</i>	<i>12.3</i>	<i>19.3</i>	<i>-9</i>	<i>+8</i>	<i>+4</i>

Compared to the unadjusted inventory, the overall volume increased approximately 30% and 32% for the 12.5 cm and 17.5 cm utilization levels (Table 10). This volume increase is statistically significant since the increase is greater than the volume sampling errors at each utilization level.

Table 10. Unadjusted and adjusted inventory statistics for volume (VT ≥ 30 years).

Land Type Priority	Utilization Level (cm)	Area (ha)	Volume		Difference (%)
			Unadjusted (m <sup>3</sup> /ha)	Adjusted (m <sup>3</sup> /ha)	
VT High	12.5	257,383	231.5	262.3	+13
	17.5		213.6	248.2	+16
VT Moderate	12.5	50,211	63.4	131.1	+107
	17.5		42.2	98.9	+134
VT Low	12.5	230,464	105.5	164.7	+56
	17.5		89.5	142.5	+59
<i>Overall</i>	12.5	<i>538,059</i>	<i>161.8</i>	<i>210.2</i>	<i>+30</i>
	17.5		<i>144.5</i>	<i>191.1</i>	<i>+32</i>

## 5. DISCUSSION

### 5.1 COMPARISON WITH 1998 INVENTORY AUDIT

The 1998 inventory audit in the TFL used VRI methods with 65 TEPs installed in the mature VT landbase. The audit average net volume (less cruiser-called decay only, 12.5-cm/17.5 cm mixed utilization levels) from these plots was 285 m<sup>3</sup>/ha with a 95% confidence interval of (250, 320 m<sup>3</sup>/ha). This audit average volume was, as expected, close to the ground net volume (281 m<sup>3</sup>/ha and 267 m<sup>3</sup>/ha for the 12.5 cm and 17.5 cm utilization levels (Table 4) in the high priority areas. This comparison confirms that the ground samples represented the population.

### 5.2 IMPACT OF VOLUME INCREASE

After adjusting all the attributes (height, age, and attribute-adjusted volume), the overall impact on existing volume was an increase of 30% and 32% for 12.5 cm and 17.5 cm utilization levels. This difference was statistically significant since the respective sampling errors (8.9% and 10%) were smaller than the respective 30% and 32% increases. The volume increase after adjusting for height and age was only 5%. Therefore, most of the volume increase is due to the model-bias correction. These increases however, do not include factors to correct for taper and hidden decay bias. Anecdotal evidence from the Dawson Creek TSA sampling suggests the NVAF correction is small, approximately 0.95. The actual factor should be confirmed by completing the NVAF sampling in TFL 48.

The impact of the adjustment on the volume in the high priority areas (the likely future timber harvesting land base) was about 13% and 16% for the 12.5 cm and 17.5 cm utilization levels. This overall upward adjustment of at least 13% for standing volume<sup>8</sup> will affect the next allowable annual cut (AAC) determination for TFL 48. While the 13% increase in standing volume does not equate to a 13% increase in the AAC, there is reason to expect the AAC may increase. In the last timber supply analysis, a sensitivity analysis indicated that a 10% increase in standing volume could increase the AAC approximately 4.5%.

### 5.3 IMPACT OF SITE INDEX INCREASE

The overall 8% increase in site index (Table 9) will have an impact on the timber supply analysis if the current inventory site index estimates are used for post-harvest regenerated stands. However, if site index for post-harvest regenerated stands are obtained from another source (i.e., from the Site Index-Biogeoclimatic Ecosystem Classification [SIBEC] database), the inventory site index increase will not impact the timber supply analysis since most of the site index increase was negligible (approximately 1%, Table 9) in the moderate priority areas (immature stands < 80 years). Site index increase in older stands does not significantly impact volume growth since these stands will not have time to capture the gain in volume before they are harvested.

If the adjusted database is re-classified by land type, there may be a land base shift from low priority to moderate priority since the site index in the low priority areas increased approximately 10%. This could have a positive impact on timber supply if the moderate areas are included in the timber harvest landbase.

---

<sup>8</sup> In timber supply analysis, mixed utilization levels are used: 12.5 cm for pine and 17.5 cm for the remaining species. Therefore, the expected overall volume average increase in the high priority areas is likely to range from 13% - 16% in the high priority areas, and 30% - 32% overall.

## 6. CONCLUSIONS

This report has provided the unadjusted inventory (Phase I), ground sampling data (Phase II), and the adjusted inventory statistics for TFL 48. The adjusted inventory is not fully compliant with the MSRM standards since NVAF sampling has not been completed. Unless the MSRM policy is modified, NVAF will be required for the next Timber Supply Review. Therefore, we recommend

*Completing NVAF sampling to satisfy the MSRM inventory standard.*

The adjusted net merchantable volume was statistically different from the volume available in the unadjusted inventory, and it represents the most accurate information available. Therefore, we recommend

*Using the adjusted VRI in the next Timber Supply Review.*

## APPENDIIX I - PHASE II GROUND SAMPLING

A total of 154 sample polygons (ground plots) were established during the period 1998-2002 (Table 11). Canfor established plots in projects 4741 and 4742. The Project 4741 plots were established for inventory audit purposes; they were selected based on the old inventory and revisited after the new Phase I to determine which auxiliary plots landed in the new polygons. Projects DDCA and DDCB plots were established by the MOF as part of the Dawson Creek Forest District sample plan. Different plot types were used in Canfor's four VRI projects. The EO1 are ecology plots, Q1 and QO1 are timber emphasis plot types, OO1 are full VRI samples, NO1 are NVAF enhanced samples, FO1 & MO1 are fixed-area plots for monitoring, and A1 are audit samples.

Table 11. Distribution of Phase II plots by project and plot type in TFL 48.

Project No.	Sample Size	Plot Type							
		OO1	O1	QO1	Q1	NO1	EO1	A1	FO1 & MO1
4742 (2001/02)	72	70		2		23	3		25
4741 (1998)	65				65	14	65		23
DDCA (1998)	11	7	4						7
DDCB (1999)	6				6		6	2	1
<i>Total</i>	<i>154</i>	<i>77</i>	<i>4</i>	<i>2</i>	<i>71</i>	<i>37</i>	<i>74</i>	<i>2</i>	<i>56</i>

When there was more than one type of plot measurement at a sample location, the order of use of the plot measurements for statistical adjustment was: OO1 & O1, NO1, and Q1 & QO1. For example, in project 4742, only the measurements in plot types OO1 and QO1 were used, and in project, 4741 measurements in all the 14 NO1 plots and in the 41 Q1 plots were used. The A1 and FO1 & MO1 plots were not used.

The distribution of the Phase II plots among the priority classes changed slightly from the sampling plan because improvements to the database explained in Section 2.1 (Table 12). The differences in the distribution of the Phase II samples are very small.

Table 12. Distribution of Phase II plots in the TFL 48.

Land Type	Sample Plan	Revised	Difference
Vegetated Treed	144	144	0
High Priority	94	91	-3
Moderate Priority	28	29	+1
Low Priority	22	24	+2
Vegetated Non-Treed & Non-Vegetated	10	10	0
<i>Total</i>	<i>154</i>	<i>154</i>	<i>0</i>