



Ministry of Forests

RESULTS INFORMATION SUBMISSION
SPECIFICATIONS

Form and Manner of Reporting

(Licensee Submissions)

5th Edition

June 30, 2023

Foreword

This document is the fifth edition of *RESULTS Information Submission Specifications for Licensees (RISS-Is)*. The document was developed in response to comments and feedback provided by users via the NRS Service Desk and Forest Science, Planning, and Practices Branch.

Acknowledgements

This edition has been revised by: Karen Stout, RPF, with assistance from the following individuals:

Caroline Wood, RPF
Scott Akerley
Taisa Brown, RPF
Sabina Donnelly, PAg
Dan Turner, RPF
Craig Wickland, RPF
Ellery Tetz, RPF

TABLE OF CONTENTS

FOREWORD	II
ACKNOWLEDGEMENTS	II
1..... APPLICATION	1
2..... PURPOSE	1
3..... REPORTING OBLIGATIONS UNDER THE FOREST PRACTICES CODE	1
4..... ELECTRONIC SUBMISSIONS	2
4.1 HELP AND SUPPORT	2
4.2 ACCESS	2
4.3 ACCOUNTABILITY	2
4.4 PREPARING SUBMISSIONS	3
4.4.1 <i>Spatial and attribute formatting structure (schema)</i>	3
4.4.1.1 XML and GML	3
4.4.2 <i>Rejected submissions</i>	3
5..... SILVICULTURE AND LAND STATUS REPORTS	4
5.1 GENERAL OPENING LIFECYCLE AND E-SUBMISSIONS	4
5.2 GENERAL CONTENT FORMAT	4
5.2.1 <i>Field specifications</i>	5
5.2.2 <i>Legal requirements override systems validation rules</i>	5
5.3 OPENING KEY	6
5.3.1 <i>Attribute data</i>	6
5.3.1.1 RESULTS and FTA	7
5.3.1.2 New submissions to RESULTS	8
5.3.1.3 Subsequent submissions to RESULTS	8
5.4 OPENING DEFINITION REPORT	8
5.4.1 <i>Timing</i>	8
5.4.2 <i>Attribute data</i>	8
5.4.2.1 Tenure (conditional).....	10
5.4.2.2 Standards	11
5.4.3 <i>Attribute details</i>	11
5.4.3.1 Tenure	11
5.4.3.2 Opening amalgamation	12
5.4.3.3 Standards ID.....	12
5.4.3.4 Previous stand label.....	12
5.4.3.5 Additional disturbances.....	12
5.4.4 <i>Spatial mapping data</i>	12
1.1.1.1.1 B	14
1.1.1.1.2 A	14
5.5 DISTURBANCE REPORT	14
5.5.1 <i>Timing</i>	14
5.5.2 <i>Attribute data</i>	15
5.5.3 <i>Attribute details</i>	16
5.5.3.1 Area-based licences	16
5.5.3.2 Multi-tenure openings	16
5.5.3.3 FRPA s. 108	16
5.5.3.4 Other disturbances.....	17
5.5.4 <i>Spatial mapping data</i>	17

5.6	SILVICULTURE ACTIVITY REPORT.....	19
5.6.1	Timing.....	19
5.6.2	Attribute data.....	19
5.6.3	Attribute details.....	22
5.6.3.1	Activity treatment units.....	22
5.6.3.2	Harvest and planting in the same reporting period.....	22
5.6.3.3	Additional disturbances.....	22
5.6.3.4	Silviculture surveys.....	22
5.6.4	Spatial mapping data.....	22
5.7	FOREST COVER INVENTORY REPORT.....	22
5.7.1	Timing.....	23
5.7.2	Attribute data.....	23
5.7.2.1	Polygon component.....	24
5.7.2.2	Inventory component.....	25
5.7.2.3	Silviculture component.....	26
5.7.2.4	Non-mapped component.....	27
5.7.3	Attribute details.....	27
5.7.3.1	Forest cover components.....	27
5.7.3.2	Stratification.....	28
5.7.3.2.1	Minimum polygon size.....	28
5.7.3.3	Multi-layer stands.....	29
5.7.3.3.1	Residuals.....	29
5.7.3.4	Reserves, roads, and other mapped features.....	29
5.7.3.4.1	Reserves fields.....	29
5.7.3.4.2	Tracking reserves.....	30
5.7.3.4.3	Mapping Reserves.....	30
5.7.3.5	Non-productive areas.....	31
5.7.3.5.1	Roads.....	31
5.7.4	Spatial mapping data.....	32
1.1.1.1.3	A.....	34
5.8	MILESTONE DECLARATION REPORTING.....	35
5.8.1	Attribute data.....	35
5.8.2	Attribute details.....	35
5.8.2.1	Electronic signature.....	35
5.8.2.2	Supporting documentation.....	36
5.8.2.3	Declarations by standards unit.....	36
5.8.2.4	Milestone due dates.....	36
5.8.2.5	Forest cover updates.....	36
5.8.2.6	Post-harvest milestone declaration.....	36
5.8.2.7	No-Regeneration milestone declaration.....	36
6 SPATIAL DATA FORMAT	37
6.1	GENERAL MAPPING STANDARDS.....	37
6.1.1	Scale.....	37
6.1.2	Position.....	37
6.1.3	Accuracy.....	37
6.1.4	Minimum resolution.....	38
6.1.5	Units.....	38
6.1.6	Tolerance for differences between attribute and spatial area data.....	38
6.2	MULTI-PART GEOMETRY.....	38
6.3	SPATIAL TOPOLOGY.....	39
6.3.1	Polygon topology.....	39
6.3.2	Linear topology.....	41
6.3.3	Common topology complexities.....	42
6.3.3.1	Spikes.....	42
6.3.3.2	Overlapping features.....	42
6.3.4	Spatial data validations.....	43
6.3.5	Topology.....	45

6.4	SPATIAL PROJECTIONS	46
7PRECISION STANDARDS	
	46

LIST OF FIGURES

Figure 1	Clearcut with two WTRAs, one SU.....	13
Figure 2	Group selection, with one SU.....	13
Figure 3	Variable retention opening with three SUs and a reserve.....	14
Figure 4	Opening containing WTRA reserves, a Clearcut SU (1) and a Seed Tree SU (2).....	14
Figure 5	Opening with reserves.....	17
Figure 6	Opening with patch cuts.....	18
Figure 7	Variable retention opening.....	18
Figure 8	Opening with reserves.....	19
Figure 9.	Examples of SU to forest cover relationships.....	32
Figure 10.	Opening comprised of three forest cover polygons.....	33
Figure 11.	Opening is a multi-pass silvicultural system with a planned re-entry.....	33
Figure 12.	Variable retention opening.....	34
Figure 13.	Opening divided into multiple forest cover polygons based on SUs, roads, and WTRAs.	34
Figure 14.	Relative positional accuracy overlay.....	37
Figure 15.	Multi-part geometry.....	39
Figure 16.	A polygon.....	39
Figure 17.	Unacceptable polygon lines.....	40
Figure 18.	Right-hand rule for polygons.....	40
Figure 19.	Features cannot overlap.....	41
Figure 20.	Line direction.....	41
Figure 21.	Lines must not intersect.....	41
Figure 22.	Separate lines.....	42
Figure 23.	Polygon spike.....	42
Figure 24.	Polygon overlap.....	43
Figure 25	Shared boundary.....	43
Figure 26.	Duplicate points.....	44
Figure 27	Self Intersecting Polygons.....	44
Figure 28.	Self intersecting polygons.....	45
Figure 29.	Polygons can be represented by using proper structure.....	45

LIST OF TABLES

Table 1	Generalized lifecycle of an opening and related e-Submissions.....	4
Table 2	Information included in each report.	5
Table 3	Opening key field specifications (Opening/cut block identifiers).....	7
Table 4	Opening definition general field specifications.....	9
Table 5	Opening definition multi-tenured openings field specifications.....	10
Table 6	Opening definition standards field specifications.....	11
Table 7	Disturbance activities field specifications.....	15
Table 8	Silviculture activities field specifications when reported by opening.	19
Table 9	Silviculture activities field specifications when reported by tenure summaries.	21
Table 10	Forest cover "polygon component" field specifications.....	24
Table 11	Forest cover "inventory component" field specifications.....	25
Table 12	Forest cover "silviculture component" field specifications.....	26
Table 13	Forest cover "non-mapped component" field specifications.....	27
Table 14	Forest Cover Components.....	27
Table 15	Milestone declarations field specifications.....	35
Table 16	Minimum precision standards for data submissions.	46

1 Application

These specifications apply to a person with:

1. an obligation to establish a free-growing stand in accordance with the *Forest and Range Practices Act* (FRPA), s. 29 (1) or s. 29 (2); and who submits silviculture reports in accordance with the *Forest Planning and Practices Regulation* (FPPR), sections 86, 87, 88, application for relief of funding in accordance with FRPA s. 108 and FPPR s. 96, and declarations in accordance with FPPR s. 97; or,
2. an outstanding obligation to establish a free-growing stand in accordance with the *Forest Practices Code of British Columbia Act* (FPCBCA), sections 69.1 and 70, and who submits silviculture reports in accordance with the *Timber Harvesting and Silviculture Practices Regulation* (THSPR), sections 45, 46, 47, and 48.

As of June 1, 2005, silviculture report submissions are electronic, as noted in the Deputy Minister letter issued on March 21, 2005. These specifications address the form and manner of electronic submissions enabled by FPPR s. 86(6) and the format of electronic submission enabled by THSPR s.47(b); and describe the minister's information requirements for forest cover inventory as defined by FPPR s.1.

Government-funded activities are reported in accordance with these specifications, and with the *Results Information Submission Specifications: Government Funded Silviculture and Forest Management Activities*.

Declarations made under FRPA s. 107 should be submitted in accordance with these specifications (to facilitate processing).

2 Purpose

These specifications provide direction on the form and manner (or format of electronic submissions for submissions that support outstanding FPCBCA obligations), of annual reporting requirements by describing electronic reporting requirements for silviculture obligations and maps. These formatting specifications ensure that data submitted electronically are successfully loaded into the ministry's electronic systems.

3 Reporting Obligations under the Forest Practices Code

The following documents remain effective for licence holders who submit in accordance with the FPCBCA and THSPR until the obligation has been met or FRPA stocking standards and/or reporting requirements are specified within an FSP in accordance with FRPA 197 (4) or (5).

1. *Industry Guide to the Preparation and Submission of RESULTS Reports through the Electronic Submission Framework*
2. *Guide to Completing FS 708 Forms*
3. *British Columbia Mapping Standards for use in RESULTS Submissions*
4. *Precision Standards for Forest Inventory or Form C Data and Map Submissions to the Ministry of Forests and Range*

Alternatively, it is the policy of the ministry that those reporting obligations are deemed to be fulfilled if they are prepared and submitted in accordance with the FRPA, the FPPR and the specifications in this document.

4 Electronic Submissions

The Electronic Submission Framework (ESF) is used by Ministry of Forests' (FOR) clients and staff to submit data including silviculture (RESULTS), forest tenure (FTA), and forest stewardship plan (FSP Tracking System), submissions. Electronic Forest Management (e-FM) is described at <https://www.for.gov.bc.ca/his/efm/>.

4.1 Help and Support

Support documentation and contact information is at <https://www2.gov.bc.ca/gov/content/industry/forestry/managing-our-forest-resources/silviculture/silviculture-reporting-results/business-and-policy-documentation>

4.2 Access

Access to the electronic submissions applications is secured through one of two accounts according to employer. Private sector personnel use British Columbia Electronic Identification (BCeID) accounts (see <https://www.bceid.ca/>); ministry personnel use Information Directory (IDIR) accounts.

To receive access, a user must be authorized by the client signatory and/or the ministry.

The FOR policy on user access and other access details are at <https://www2.gov.bc.ca/gov/content/industry/forestry/managing-our-forest-resources/silviculture/silviculture-reporting-results/business-and-policy-documentation>.

4.3 Accountability

Licensees are accountable for e-submissions to RESULTS and should ensure that individuals submitting information on their behalf are authorized by the license holder (or someone authorised by the license holder in that regard) and that the information being submitted has been collected and prepared by qualified professionals (i.e., Registered Forest Professionals). A BCeID and password is considered an electronic signature of an individual authorised by the licensee to submit data on behalf of the licensee. A document that is submitted and approved electronically is considered to be an official document, provided it meets regulatory requirements and is submitted by an authorised individual.

Documents prepared by qualified professionals, that are the basis of the data in e-submissions, may be attached as pdf files to the e-submission and/or retained on the licensee file.

4.4 Preparing Submissions

Electronic submissions are processed through:

1. licensee information systems and specialized tools that create the electronic format required for ESF submissions to RESULTS; or,
2. service providers who prepare and submit on behalf of a licensee.

4.4.1 Spatial and attribute formatting structure (schema)

Attribute and spatial data are integrated in RESULTS ESF submissions. This minimizes interpretation errors in relating the spatial with the attribute data. The format is structured to contain data about individual features (e.g., an opening and attributes) and data about how the features relate to one another. A formatting structure for a given report type is referred to as a "schema".

Details for how to prepare and submit reports are available at

<https://www.for.gov.bc.ca/his/efm/>

Technical specifications describing the structure of RESULTS submissions are at

<https://www2.gov.bc.ca/gov/content/industry/forestry/managing-our-forest-resources/silviculture/silviculture-reporting-results/technical-documentation>

4.4.1.1 XML and GML

Any given RESULTS electronic report is comprised of schema that contains XML and GML components. Spatial data (map) is configured in geographic mark-up language (GML); attribute (alpha-numeric text) data in extensible mark-up language (XML; i.e., <submission_file.xml>).

Information on configuring XML data is at

<https://www2.gov.bc.ca/gov/content/industry/forestry/managing-our-forest-resources/silviculture/silviculture-reporting-results/technical-documentation>. Additional details are at <http://www.for.gov.bc.ca/his/results/webhelp/index.htm>; Tab: RESULTS—Tech Specs – Electronic Submissions—XML Schema (or XML Example). Or Tab: RESULTS—Online Tech Specs—Tech Specs—Requirements and choose the applicable document.

4.4.2 Rejected submissions

RESULTS may reject submissions that are not configured according to required schema, or if errors are encountered through the system's validation checks. An error message is included with a rejection notification. Click the hyperlinked error message identification number or navigate to the [technical documentation](#), Tab: RESULTS—Error Messages – Electronic Submissions) to view a description of the error, and possibly a recommended solution.

FOR officials may review or inspect submissions after they have been accepted by RESULTS to determine if they meet legislative requirements and information submission specifications.

5 Silviculture and Land Status Reports

5.1 General opening lifecycle and e-submissions

Throughout the opening lifecycle from the initial disturbance until a forest stand reaches free-growing status, licensees periodically submit to FOR information reports about openings (e.g., stocking standards, silviculture activities, forest cover, amendments, and declarations). Timing of these submissions is generalized in **Table 1**.

Table 1 Generalized lifecycle of an opening and related e-Submissions.

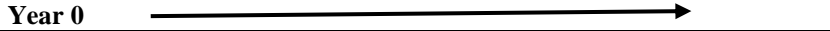
Stage in Lifecycle:	Harvest	Planting	Regeneration Survey(s)	Silviculture Treatments (e.g., brushing, spacing, pruning)	Free-growing Surveys
					
Report Type:	Opening Definition [FPPR 87]; Disturbance [FPPR 86(3)(a), 86(5)]; Forest Cover [FPPR 86(3)(a), 86(5)]	Silviculture Activity [FPPR 86(3)(c), 86(5)]	Forest Cover [FPPR 86(3)(d), 86(5)]; Milestone Declaration [FPPR 97]	Silviculture Activity [FPPR 86(3)(e), 86(5)]	Forest Cover [FPPR 86(3)(d), 86(5)]; Milestone Declaration [FPPR 97]

5.2 General Content Format

A submission can contain more than one opening, and each opening can contain more than one report (opening definition, disturbance, silviculture activity, forest cover polygon, or milestone declaration). For example, a RESULTS submission could contain several openings, with silviculture activities reports for all openings, a forest cover report, and milestone declarations for some openings, provided that the submissions are for the same licensee, within the same forest district, and have the same contact person. Submission components vary depending on the type of report.

If a submission contains several reports for a given opening, and one report fails the automated validation tests, all reports for that opening will fail. Reports for other openings in the same submission may pass if they pass the validation tests.

Some components are common to all RESULTS reports (Table 2).

Table 2 Information included in each report.

Submission Header	Information that ensures that the submission is processed correctly by the ESF system (including schema location and processing information).
Submission Metadata	Contact information, including email address and phone number, of the person making the submission. A service provider who prepares a submission on behalf of a licensee provides the licensee contact information.
Submission Content	A name and description of the submission (a folder containing the RESULTS metadata and openings).
RESULTS Metadata	General information about the RESULTS submission. Includes the forest district code, ministry client code, client location code (identifies different divisions of a company), licensee contact name, phone number and email address, date the submission was created, and a validation indicator (indicates whether the submission should be uploaded to RESULTS, or validated, not uploaded). The ministry client code and client location codes are assigned by the ministry and can be viewed in RESULTS on any existing opening or by searching the client field.
Opening	Information about the opening for a given submission including opening key, opening definition, disturbance, silviculture activity, forest cover polygons, and milestones. One or more openings may be included per submission, and one or more opening items may be included per opening.

5.2.1 Field specifications

Field specifications are described in the *field specifications* tables in the *Attribute data* section for each report type. Fields are designated as **required** ("yes"), **optional**, or **conditional** (per conditions specified in the "Description and Conditions" columns). Items listed as "required" in this document are for openings managed under FRPA.

Openings managed under the former FPCBCA are subject to content requirements per that Act and its associated regulations (not specified in this document). Alternatively, it is the policy of FOR that any openings managed under FPCBCA, submitted in accordance with FRPA and the specifications of this document, are deemed to have met FPCBCA requirements. Licensees who choose not to follow the content specifications in this document continue to use the direction of the former FPCBCA and its associated regulations, along with the submission guides to support those reporting requirements (Section 3), to meet reporting requirements of that Act, with the exception that reports are submitted electronically.

5.2.2 Legal requirements override systems validation rules

RESULTS has validation rules that coarsely screen reports according to whether format and/or general content requirements are met; nevertheless, RESULTS is not programmed to fully reflect all legal nuances. For this reason, some reports may "pass" validation rules but otherwise not meet legislated requirements. Licensed forest professionals who collect and prepare data for the reports are responsible to ensure that legal requirements are satisfied. Reports are subject to FOR audits. Reports that pass the RESULTS validation

rules, but that otherwise do not meet legislated requirements may be subject to compliance or enforcement action if detected during an audit.

5.3 Opening Key

The opening key identifies an opening in an XML/GML submission and links the current report to the correct opening in the RESULTS database.

No spatial data are included with this component of a report. The tenure information stored in FTA and the opening information in RESULTS are not linked spatially.

5.3.1 Attribute data

One opening key (tenure, timbermark, opening number, or opening ID) is required per report. More than one opening key can be included in a report, provided that they refer to the same opening. Field specifications are listed in Table 3

.

Table 3 Opening key field specifications (Opening/cut block identifiers)

Field	Required	Description and Conditions
TENURE KEY conditional Consists of Licence Number, Cutting Permit <u>and</u> Cutblock. Required for new submissions. Not required if Timbermark Key is used.		
Licence Number	yes	Licence number of the opening corresponding to the cutting authority. e.g., TFL49; A19204; W0012.
Cutting Permit	conditional	Cutting permit for the opening corresponding to the licence in the cutting permit document. Include for new submissions if a cutting permit exists for the opening.
Cutblock	yes	Approved cutblock identifier for the opening as on the legal Exhibit A document. No leading zeros (unless the zeros exist in FTA). Special characters and spaces not recommended (e.g., -, /, _, *). e.g., 1002LM.
TIMBERMARK KEY conditional Consists of Timbermark <u>and</u> Cutblock. Required for new submissions. Not required if Tenure Key is used.		
Timbermark	yes	Timbermark for the opening as shown on the legal documents. e.g., Examples: FT8675; 67801
Cutblock	yes	See remarks for Cutblock under Tenure Key.
OPENING NUMBER KEY conditional Consists of mapsheet components <u>and</u> opening number. If the opening does not already have an opening number, the numbers are automatically assigned by RESULTS upon submitting the opening definition. For the opening number to be assigned by the system, opening spatial must be supplied. Once an opening number has been assigned to an opening, that number can be used as the opening key for future submissions to RESULTS. The opening number can be manually entered/modified on the Opening Inquiry screen. e.g., mapsheet grid/ letter/ square/ quad/ subquad/ opening number: 92L 012 0.0 163.		
Mapsheet Grid	yes	Mapsheet grid number of the NTG or BCGS grid. e.g., 082; 083; 113; 114.
Mapsheet Letter	yes	Mapsheet letter of the NTG or BCGS grid. e.g., A–P and W.
Mapsheet Square	yes	BCGS number or NTG number and letter. BCGS numbers are 1–100, and NTG numbers and letters are 1–16 and A–H and W respectively.
Mapsheet Quadrant	conditional	Blank if NTG number/letter entered and 0–4 if BCGS number entered.
Mapsheet Subquadrant	conditional	Blank if NTG number/letter entered and 0–4 if BCGS number entered.
Opening Number	yes	Unique identifier that describes an opening on a specified mapsheet.
OPENING ID KEY optional Assigned during the first submission to RESULTS. May be used instead of Tenure Key, Timbermark Key, or Opening Number Key for subsequent submissions.		
Opening ID	yes	Unique identification number generated automatically by RESULTS. Assigned to an opening when the first submission for that opening is made. Used to uniquely identify a harvest entry. For example, if the opening had a first pass harvest in 1975, and a second pass harvest in 2000, each harvest entry would have a different opening ID, although the opening number may be the same. This allows obligations related to each harvest entry to be tracked separately. e.g., 61100; -337170000; 9528

5.3.1.1 RESULTS and FTA

An approved cutblock **must** exist in FTA before its corresponding opening definition is accepted by RESULTS (exceptions: non tenured openings associated with government funded activities or other resource based activities such as mining.)

The opening tenure key or the opening timbermark key must be identical to the tenure/timbermark information in FTA, or an error is generated.

5.3.1.2 New submissions to RESULTS

When openings are submitted to RESULTS for the first time (i.e., the opening did not previously exist in the RESULTS database), **either** the tenure key **or** the timbermark key is used. The key must match **exactly** with the cutblock identifiers in FTA.

If the tenure or timbermark key does not match the format in FTA, the submission is rejected. If the RESULTS opening key matches with FTA, an opening is created in RESULTS and corresponding tenure information from FTA populates RESULTS.

5.3.1.3 Subsequent submissions to RESULTS

If the opening already exists in RESULTS, subsequent submissions to RESULTS can use the opening tenure key, the opening timbermark key, the opening number key, or the opening id key.

5.4 Opening Definition Report

The opening definition report contains descriptive information about the cutblock (FPPR s. 86[3][a][1]) and information relating to reforestation standards (FPPR s. 87[1]), including previous stand information, maximum allowable permanent access structure, and standard unit (SU) information. Any opening that is part of a multi-tenure cutblock is identified in the opening definition. The opening definition includes attribute and spatial data.

5.4.1 Timing

An opening definition report is required with the first RESULTS submission for an opening (i.e., after completion of harvest), and may be submitted thereafter to update previously submitted information in accordance with FPPR s.87(4). This report normally accompanies a disturbance report on or before June 1 for all areas on which harvesting occurred in the previous fiscal year (April 1 through March 31).

5.4.2 Attribute data

A single opening definition identifies the entire opening. An opening definition can contain multiple SUs, each with their own attribute and spatial information. A given opening may have more than one tenure (multi tenure openings) with attribute information.

Field specifications are listed in Table 4 (general), Table 5 (multi-tenured openings), and Table 6 (standards).

Table 4 Opening definition general field specifications.

Field	Required	Description and Conditions
Action	yes	Code that identifies the purpose of the opening definition report. I – Insert (for new opening definitions submitted for the first time) U – Update (for correcting existing opening definition data. <u>All</u> existing opening definition data is deleted and replaced with the corrected data. Users supply <u>all</u> information for all components of the opening definition. O – Opening Amalgamation (for proposing amalgamations in the XML document) V – Variation (for including a previously approved FSP variation to a stocking standard regime associated with a site plan) A – Amendment (Major) (for major amendments to silviculture prescriptions that require FOR approval; also used for Site Plan Amendments that do not require FOR approval). M – Amendment (Minor) (for minor amendments (per FPCBCA 42.1, and OSPR 7.1) to silviculture prescriptions that do not require FOR approval.
Opening Gross Area	yes	The total area of the opening inclusive of all SUs (NAR), roads, reserves, and non-productive areas.
Licensee ID	optional	An ID supplied by the Licensee to identify the opening or cross reference to Licensee records.
Opening Category	yes	Code indicating who holds the obligation and the extent and nature of the obligation. See the RESULTS Technical Specifications to locate Opening Category Code list. e.g., FTML – Forest Tenure Major Licensee; NDFS – Natural Disturbance – Forest Service.
Opening Location Name	optional	Identifies the location name of the opening. e.g., Petersen Creek; Foresters Mountain.
Previous Stand Type	yes	Code that identifies the previous stand type, from the previous forest cover inventory label of the largest polygon in the opening. See the RESULTS Technical Specifications to locate Stand Type Code List. e.g., MAT – mature stands; IMM – immature stands.
Previous Species 1	yes	Code that identifies the dominant species of the stand before harvest, from the previous forest cover inventory label of the largest polygon in the opening. See the RESULTS Technical Specifications to locate Species Code list.
Previous Species 2	conditional	Code that identifies the second major species of the stand before harvest in a multi-species stand from the previous forest cover inventory label of the largest polygon in the opening. Required if more than one major species was present in the previous stand label. See the RESULTS Technical Specifications to locate Species Code list.
Previous Age Class	yes	Code indicating the age class of the previous stand type, from the previous forest cover inventory label of the largest polygon in the opening. Age classes are intervals, or ranges, of ages into which trees, forests, stands, or forest types are classified. See the RESULTS Technical Specifications to locate Age Class Code list.
Previous Height Class	yes	Code indicating the height class of the previous stand, from the previous forest cover inventory label of the largest polygon in the opening. Height classes represent intervals into which the range of tree or stand heights are classified. See the RESULTS Technical Specifications to locate Height Class Code list.
Previous Stock Class	yes	Code indicating previous stocking class of the stand, from the previous forest cover inventory label of the largest polygon in the opening. See the RESULTS Technical Specifications to locate Stock Class Code list. e.g., 1 – stock class 1; 2 – stock class 2; R – mature residual.

Field	Required	Description and Conditions
Previous Site Index	yes	The site index of the leading tree species in the previous stand, from the previous forest cover inventory label of the largest polygon in the opening. Estimates forest land productivity. Enter the projected average height, in metres, of the leading species of the forest cover label at 50 years after the stand achieves breast height (1.3 m).
Previous Site Index Source	yes	Code that describes the source or origin of the previous site index, from the previous forest cover inventory label of the largest polygon in the opening. See “11. Selecting a method to estimate site index” on the FS 660 (http://www.for.gov.bc.ca/isb/forms/lib/FS660.PDF) See the RESULTS Technical Specifications to locate Site Index Source Code list. e.g., C – site index from site index curve; H – site index from stand before harvest.
Maximum Allowable Permanent Access Percentage	conditional	The maximum percentage of the gross area of the opening that can be occupied by permanent access structures. Includes roads, landings, gravel pits, burrow pits, and permanent trails. For openings reported under: FPPR: default value is 7.0%. Enter values that differ from the default value. THSPR: Enter values to satisfy Form A requirements.
Site Plan Exemption	yes	Values of either Y (yes) or N (no). Set the value to ‘Y’ if the opening is managed under FPCBC and set to ‘N’ if the opening is managed under FRPA.
Tenure	yes	See Table 5
Standards	yes	See Table 6

5.4.2.1 Tenure (conditional)

Tenure information (Table 5) is required for any opening governed by more than one tenure. Online, these fields are in the *RESULTS305-Multi-Tenure* screen. These fields are different from the Opening Key fields, in that they assign the primary tenure to the opening.

Table 5 Opening definition multi-tenured openings field specifications.

Field	Required	Description and Conditions
9Licence Number	yes	Licence number of the opening (or of a portion of the opening) corresponding to the cutting authority.
Cutting Permit	conditional	Cutting permit for the opening (or portion of the opening) corresponding to the licence in the cutting permit document. Required if a cutting permit applies to the opening.
Cutblock	yes	Approved cutblock identifier for the opening (or portion of the opening). Special characters are not recommended (e.g., -, /, -, *).
Is Prime Licence	yes	Values of Y (yes) or N (no). Set to ‘Y’ for the primary tenure (i.e., the managing tenure) of the opening, and set to ‘N’ for the secondary tenure(s) within the opening.

5.4.2.2 Standards

Table 6 Opening definition standards field specifications.

Field	Required	Description and Conditions
SU	yes	A licensee assigned identifier for the Standards Unit. e.g., 1, 2, 3; or X, Y, Z. A single opening has one or more SUs.
Net Area	yes	Net area of the SU (i.e., not including roads, reserves, non-productive areas). Greater than zero. Sum of all SU net areas cannot exceed opening gross area. For roadside harvest operations, the portion of roadside work areas located outside the road prism is included in the net area to be reforested (NAR) and not in the estimate of the area occupied by permanent access structures.
BGC Zone	yes	Biogeoclimatic zone of the SU, according to the Biogeoclimatic Ecosystem Classification (BEC) system. e.g., IDF; MS; CWH.
BGC Sub-zone	yes	Biogeoclimatic sub-zone of the SU, according to the BEC system. e.g., dk; xc; mk.
BGC Variant	conditional	Biogeoclimatic sub-zone variant, according to the BEC system. Include if BEC variant applies to the SU. e.g., 1; 2.
BGC Phase	conditional	Biogeoclimatic phase, according to the BEC system. Include if BEC phase applies to the SU.
BGC Site Series	yes	Site series for the given biogeoclimatic unit, according to the BEC system. Corresponds to the ministry site series number. e.g., 01; 04; 05.
BGC Site Seral	conditional	Seral type for certain site series, according to the BEC system. Include if a BEC seral type applies to the SU.
BGC Site Type	conditional	Site type of the given site series, according to the BEC system. Include if BEC site type applies to the SU.
Maximum Allowable Soil Disturbance Percentage	yes	Maximum percentage of the soil surface which can be disturbed by harvesting or silviculture activities. Greater than or equal to zero. If not submitted, defaults to 5.0% for new SUs.
Standards ID	conditional	A number that relates to an approved set of stocking standards contained in either a forest development plan (FDP) or a forest stewardship plan (FSP). FSP Standards IDs are assigned by the FSP Tracking System and can be used in RESULTS once the FSP (and any subsequent amendments) is approved in the FSP Tracking System. FDP stocking standards conforming to pre-FRPA legislative requirements continue to be submitted to RESULTS through the current "Standards Proposal" tool and require district manager approval.

5.4.3 Attribute details

5.4.3.1 Tenure

The tenure information in FTA is added to the RESULTS opening definition automatically. If an opening has multiple tenures (e.g., a timber licence [TL] within a tree farm license [TFL], or private land within a TFL), each tenure is listed. One of the tenures must be identified as the Prime Licence in RESULTS; and the other tenure(s) must be identified as the secondary tenure(s) by setting the "Is Prime Licence" field to "no" for those tenures.

5.4.3.2 Opening amalgamation

Openings can be amalgamated into a single opening to support FPPR s. 111 amalgamations.

5.4.3.3 Standards ID

Only approved Standards IDs are available in RESULTS for assignment to SUs (e.g., provincial default standards, district-wide standards [if available], standards approved as part an FDP specific to a licence holder, or FSP standards approved for a given licensee through the FSP Tracking System).

Once a Standards ID is assigned to an opening in a RESULTS report, it is automatically linked to the approved stocking standards, which can be viewed in RESULTS, the FSP Tracking System, or through the CRS.

5.4.3.4 Previous stand label

The previous stand label fields include Previous:

Stand Type, Species 1, Species 2, Age Class, Height Class, Stock Class, Site Index, and Site Index Source.

Report the previous forest cover inventory label information, unless better information is available (e.g., pre-harvest survey or timber cruise) for the previous stand label fields. No new survey information is required for these fields. If the opening has more than one existing forest cover label, use the label from the largest polygon in the opening.

5.4.3.5 Additional disturbances

Disturbances such as wildfires periodically impact existing openings. Licensees may amend existing site plans or silviculture prescriptions or create new site plans (to replace the previous ones), to ensure that the Standards IDs/stocking standards for the SUs are appropriate for managing the disturbed site. Updated disturbance, silviculture activity and forest cover reports are submitted for the opening. Opening definitions may require modifications to SUs and Standards IDs/stocking standards.

5.4.4 Spatial mapping data

Spatial information is required with opening definition reports.

The opening definition contains two spatial components: 1) the opening boundary; and, 2) the SU boundaries. An opening can have no more than one opening boundary and can have one or more SU boundaries according to the number of SUs within the opening.

The opening boundary defines the location of the opening inclusive of roads, reserves, productive, and non-productive areas. The SU boundaries define each SU within the opening.

The opening in **Figure 1** consists of one SU and two wildlife tree patches (WTRAs) that have the same attribute information. The opening definition includes the entire opening boundary, including the external WTRA. The SU boundary excludes the WTRAs.

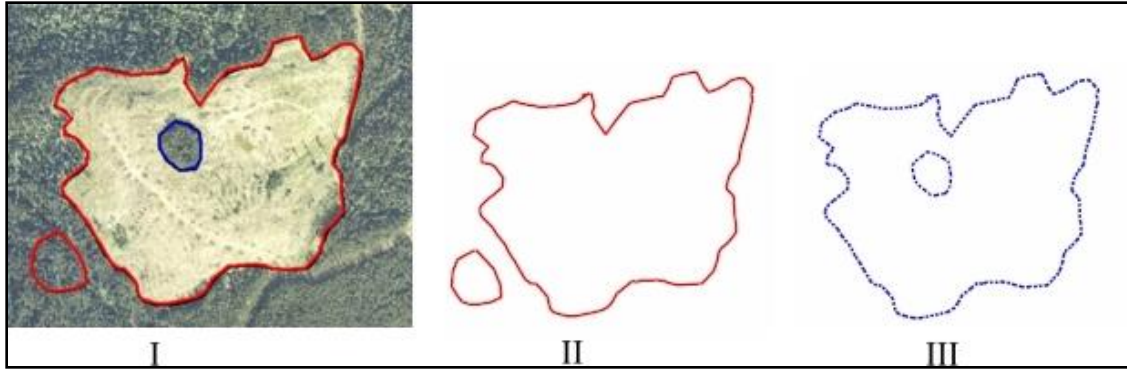

Figure 1 Clearcut with two WTRAs, one SU.

II) Opening Gross Area comprises NAR, temporary access road, and WTRAs, and is a multi-part polygon.
 III) SU spatial data. Represents the NAR of the SU. Excludes WTRAs and is a polygon with an internal hole.

The opening in **Figure 2** is comprised of harvested patches and mature timber, and can be reported three ways, according to management objectives and how the opening information is configured in FTA. The opening boundary can be: 1) an all-encompassing polygon, with the SU comprised of all the harvested groups; 2) the same as the patches of SU boundary; or, 3) a separate opening for each patch where the opening boundaries correspond to the SU boundaries. The example in **Figure 2** illustrates the first approach.

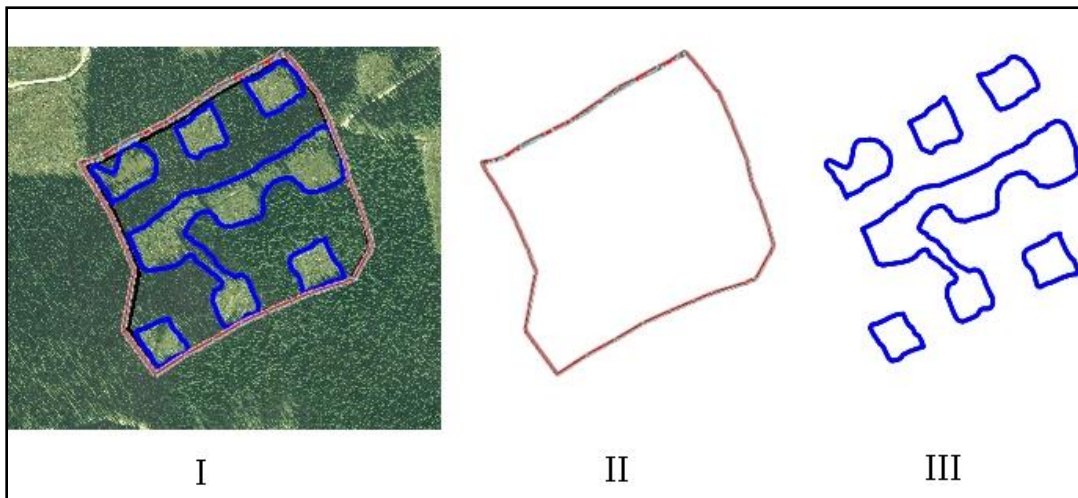

Figure 2 Group selection, with one SU.

II) Opening boundary includes all the patches, residuals, and temporary access structures in the opening.
 III) SU Spatial data. The patches and temporary access roads are included in the SU boundary. A single multi-part polygon.

The opening in **Figure 3** is a variable retention opening with three SUs defining distinct stand structures, plus a reserve.

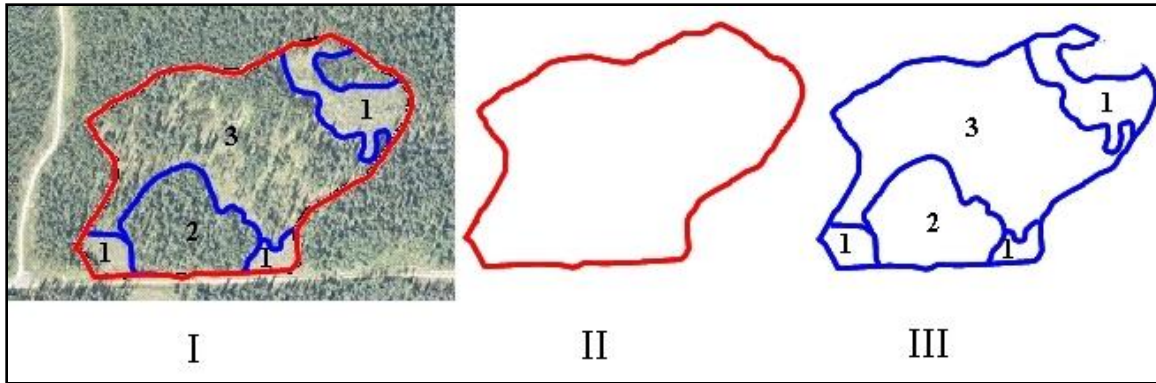

Figure 3 Variable retention opening with three SUs and a reserve.

II) Gross Opening boundary includes SUs and the reserve. III) Three SUs are delineated: 1-multi-part polygon that consists of a clearcut (top) and two landings (bottom) that are managed according to the same stocking standards and allowable soil disturbance %; 2-an area within which light single-tree selection harvest has occurred (not discernible on the photo); 3-an area within which group selection harvest has occurred.

The opening in **Figure 4** contains reserves, a clearcut SU, and a seed tree SU.

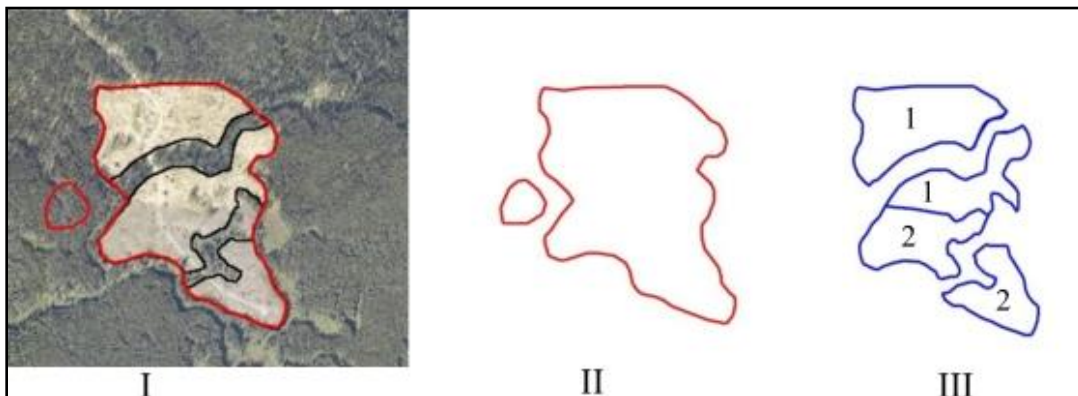

Figure 4 Opening containing WTRA reserves, a Clearcut SU (1) and a Seed Tree SU (2).

II) Gross opening area boundary comprises all SUs, WTRAs, and temporary access roads. A single multi-part polygon. III) SU boundaries. Each SU (1 and 2) is a separate, multi-part polygon.

5.5 Disturbance Report

Disturbance reporting includes information specific to the disturbance of an opening, such as type of disturbance, type of silvicultural system, harvest start and completion dates, tenure, and net area of the disturbance. The disturbance report includes attribute data. Disturbance spatial data is optional. Forest cover reports are submitted with disturbance reports.

5.5.1 Timing

Disturbance information is submitted before June 1 for areas where harvesting has been completed during the previous fiscal year ending March 31, or for cutblocks with silviculture obligations not yet declared free-growing that have been disturbed by some other natural or non-natural event prior to March 31 of that year. This information is also

submitted for areas, subject to stocking standards under FPPR 16(4) (e.g., no regeneration obligations such as commercial thinning, intermediate harvest or special forest products).

The disturbance start date is mandatory and indicates the start date of the disturbance activity. Harvesting commencement does not include road building activity. The first disturbance start date is used to set the milestone due dates for SUs with regeneration and free growing obligations.

The disturbance completion date indicates the completion of primary harvesting activities (falling and yarding). The disturbance completion date is used to set the post-harvest milestone due dates for stands with no regeneration obligations managed under FPPR 44(4) (i.e., commercial thinning) whereby a post-harvest survey is conducted to confirm residual stand condition.

A disturbance report **may** be submitted prior to completion of harvesting on an opening, e.g., to report the portion of an opening that was harvested. The opening definition must either have been previously submitted or submitted concurrently with the disturbance report.

5.5.2 Attribute data

An opening can have one or more disturbance reports. A separate disturbance report is submitted for each distinct silvicultural system in an opening. Attribute field specifications are listed in **Table 7**.

Table 7 Disturbance activities field specifications.

Field	Required	Description and Conditions
Action	yes	Values of either I (Insert) or U (Update). ‘I’ is for new disturbance reports to RESULTS, and ‘U’ is to update disturbance reports previously submitted to RESULTS.
ATU ID	no	An automatically generated sequential number to identify a specific Activity. May be used to update information for a given disturbance.
Licensee ID	optional	Allows licensee to provide a unique identifier for the disturbance.
Licence Number	yes	Licence number of the opening corresponding to the cutting authority. e.g., TFL49; A20019; W0012.
Cutting Permit	conditional	The cutting permit for the opening corresponding to the licence in the cutting permit document, if one exists.
Cutblock	yes	The approved cutblock identifier for the opening. No leading zeros. Special characters and spaces are not recommended (e.g., -, /, _, *). e.g., 1002LM.
Disturbance Code	yes	Code indicating the reason for the disturbance within the opening. See the RESULTS Technical Specifications to locate Disturbance Code list e.g., B; F; L; S.
Disturbance Start Date	yes	Start date of the disturbance. Harvest commencement does not include road building activity. Not greater than today’s date.

Field	Required	Description and Conditions
Disturbance Completion Date	yes	Date when the disturbance is completed, after completion of primary harvesting activities (falling and yarding). Other activities or further requirements under the cutting authority are classified as post-harvest activities. Used to determine milestone declaration dates. Not greater than today's date.
Disturbance Area	yes	Area (ha's) of the opening that was disturbed by the present activity. Includes: NAR, newly created roads, other unnatural non-productive features (e.g., NP UNN – gravel pits, landings), and natural non-productive sites (e.g., NP NAT, NCC – rocky outcrops, small swamps) too small to map. Does not include: retained (undisturbed) areas such as WTRA or other reserves of mature or immature timber, previously existing roads, mappable natural non-productive areas (e.g., NP NAT – rock, swamps), or mappable non-commercial cover (e.g., NCC – brush) identified on the site plan that is excluded from the NAR.
Silvicultural System	yes	Code that identifies the primary category of silvicultural system used and is either even-aged or uneven-aged. Different silvicultural systems in an opening are reported separately. See the RESULTS Technical Specifications to locate Silviculture System Code list.
Silvicultural Variant	conditional	Code that further describes the spatial layout of the silvicultural system. Include if a variant applies to the silvicultural system. See the RESULTS Technical Specifications to locate Silvicultural Variant Code list.
Silvicultural Cut Phase	yes	Code that describes the harvest entry or timing of the cut within the prescription. See the RESULTS Technical Specifications to locate Silvicultural Cut Phase Code list.
Is Harvest Complete	yes	A Yes/No indicator identifying if the primary harvest activities were completed on the cutblock. This field sets the status of the cutblock in FTA to 'LC' (logging complete).

5.5.3 Attribute details

5.5.3.1 Area-based licences

Holders of area-based licences that are subjects of pilot projects report area harvested by calendar year, not at completion of harvest (FRPA s. 175). This allows cut control to be assessed in accordance with provisions under the (*Forest Act*) *Tree Farm Licence Area-based Allowable Annual Cut Trial Program Regulation*.

5.5.3.2 Multi-tenure openings

Disturbances on multi-tenure openings are reported separately for each tenure or block. For example, if an opening located within a TFL includes a TL, two disturbance reports are submitted: one disturbance report (attribute data) for the portion of the opening in the TFL (excluding the TL area), and one disturbance report (attribute data) for the portion of the opening in the TL.

5.5.3.3 FRPA s. 108

If an event causing damage (e.g., fire, landslide, or flood) that meets the requirements of FRPA s 108 and FPPR s 96 has affected an area, FRPA s. 108 may provide funding or

relief of obligation. Before submitting a FRPA s. 108 application, submit a disturbance report identifying the disturbance event (including spatial location). Include a description of the event and the cutblock/opening showing the affected area, along with a forest cover report. For details on FRPA s. 108 reports please refer to the RESULTS Information Submission Specifications for Government Funded Activities.

5.5.3.4 Other disturbances

Reporting disturbances, other than harvesting, maintains accuracy in provincial forest cover databases and provincial timber supply analysis. Licensees report disturbances that affect licensee operations (e.g., fires or other events that impact free-growing obligations).

5.5.4 Spatial mapping data

Spatial disturbance area data is optional. Disturbance area consists of the NAR, newly created roads, other unnatural non-productive features (e.g., NP UNN – gravel pits, landings), and natural non-productive sites (e.g., NP NAT, NCC) too small to map.

Where multiple tenures govern a block, the reported disturbance area is apportioned by tenure.

Figure 5 through Figure 8 show examples of different configurations of disturbed areas.

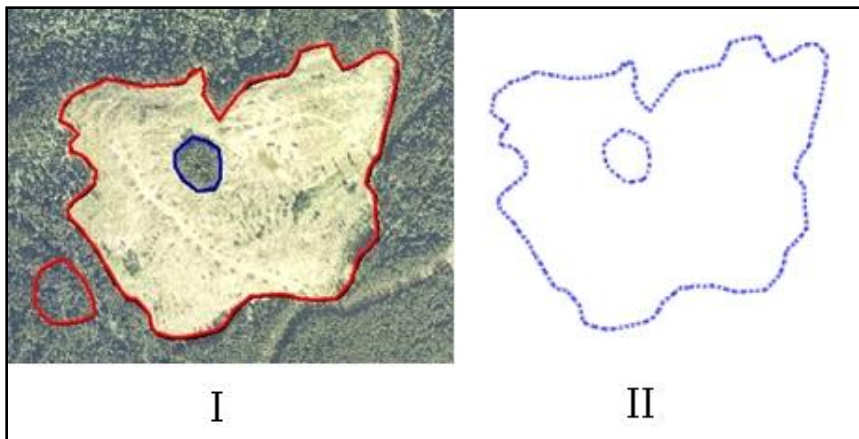

Figure 5 Opening with reserves.

II) Spatial data for the disturbed area of the opening. This is a polygon with an internal hole.

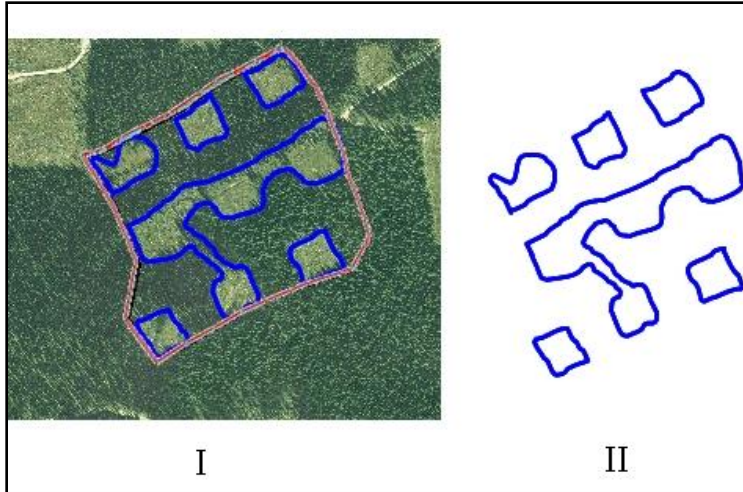

Figure 6 Opening with patch cuts.

II) Spatial data for the disturbed area of the opening. A multi-part polygon.

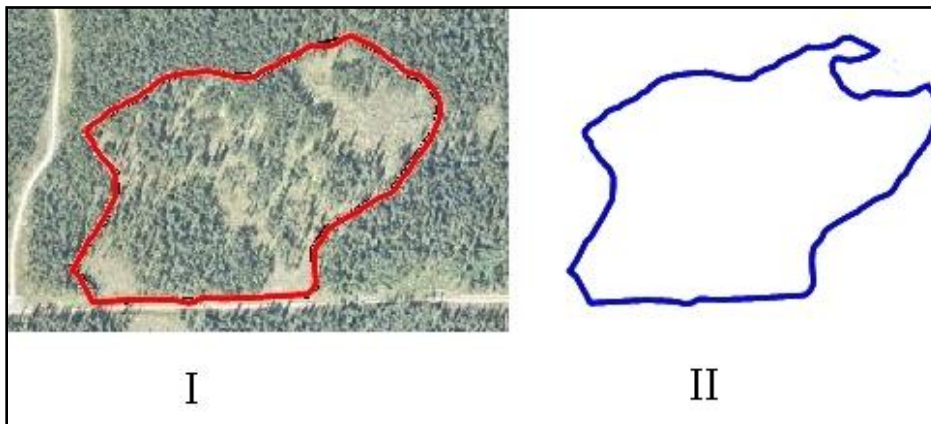

Figure 7 Variable retention opening.

II) Spatial data for the disturbed area of the opening. In this case, only the reserve is excluded from the disturbed areas. The single tree and group tree selection areas are considered part of the disturbed area because forest cover has been lightly altered.



Figure 8 Opening with reserves.

II) Spatial data for the disturbed area of the opening

5.6 Silviculture Activity Report

The silviculture activity report includes information specific to silviculture treatments, as defined by FPPR s.1, in an opening, including type of treatment, objectives, funding source, and area treated. Attribute data are required, and spatial data are optional.

FRPA requires submission of annual silviculture treatment summary reports. Use one (not both) of two possible reporting methods to meet this requirement:

1. **Reports by Opening**. The silviculture activity reports are submitted for each opening through ESF. Data is submitted **by Opening** under any of the following circumstances:
 - government-funded projects;
 - openings on which planting activities have been completed; or,
 - openings with outstanding FPC obligations.
2. **Summary Reports by Tenure**. The summary data for the tenure is entered into the **RESULTS341 – Annual Silviculture Accomplishments** screen, accessed by the **Data Submission** drop-down menu in RESULTS (online only). Required fields are District, Licence, Fiscal Year Ending, Base, Technique, Method, Funding Source, and Area (ha). *Licenseses who report silviculture treatments by individual openings for **all** treated openings are **not** required to submit annual silviculture summaries through the **RESULTS341 – Annual Silviculture Accomplishments** screen.*

5.6.1 Timing

Silviculture treatment information is submitted before June 1 for areas treated before April 1 of that year.

5.6.2 Attribute data

Attribute field specifications for silviculture activities reported by opening are listed in **Table 8**. An opening can have one or more silviculture activity reports. **Table 9** shows attribute field specifications for silviculture summaries reported by tenure.

Table 8 Silviculture activities field specifications when reported by opening.

Field	Required	Description and Conditions
Action	yes	Values of either I (Insert) or U (Update). 'I' is for new reports to RESULTS, and 'U' is to update silviculture activity reports previously submitted to RESULTS.
ATU ID	no	An automatically generated sequential number to identify a specific Activity. May be used to update subsequent information (online) for a given treatment.
Activity Base	yes	Code that identifies a primary category of silviculture treatment or activity. See the RESULTS Technical Specifications to locate Activity Base Code list.

Field	Required	Description and Conditions
Technique	conditional	Code that identifies a general technique for accomplishing silviculture activity and may be a descriptor of the base activity. Depends on Activity Base. See the RESULTS Technical Specifications to locate Activity Technique Code list.
Method	conditional	Code that identifies a specific method for accomplishing silviculture work and is a subdivision of technique. Methods describe a physical process for accomplishing work. Depends on Activity Base/Technique. See the RESULTS Technical Specifications to locate Activity Method Code list.
Activity Cost	optional	Projected cost of the planned activity if the <i>Actual Date Indicator</i> is set to "no". Actual cost of the completed activity if the <i>Actual Date Indicator</i> is set to "yes". (Required for government-funded activities.)
Objective 1	Conditional	Code that describes the reason for the silviculture treatment. Depends on Base Activity. See the RESULTS Technical Specifications to locate Objective Code list.
Objective 2	optional	Code that describes the reason for the silviculture treatment. Depends on Base Activity. Three objectives per activity are allowed. See the RESULTS Technical Specifications to locate Objective Code list.
Objective 3	optional	Code that describes the reason for the silviculture treatment. Depends on Base Activity. Three objectives per activity are allowed. See the RESULTS Technical Specifications to locate Objective Code list.
Actual Date Indicator	yes	A "yes" or "no" indicator. Set to "yes" if the activity has been completed.
Activity Date	yes	Date of the completed activity. If the <i>Actual Date Indicator</i> is set to "yes", this is the date on which the activity was completed. Required if the activity is complete.
Licensee ID	optional	Licensee Activity ID. A unique identifier provided by the Licensee to identify the activity. Used to submit an update to an existing activity. RESULTS uses the Licensee ID to identify the treatment record to be updated. To update an activity without a Licensee ID, ATU ID (available online) for the activity can be input in the Licensee ID field.
Funding Source	yes	Code that identifies the funding source for silviculture treatment. See the RESULTS Technical Specifications to locate Funding Source Code list. e.g., IA – industry appraisal; FIP – Forest Investment Program administrated; FRP -s.108 FRPA Application Funding.
Interagency Number	no	FIP Interagency (project) number.
Treated Amount	yes	The net area treated.
Planting Stock (conditional) When the activity base is PL (planting) and "Actual Date" indicator is set to "yes" the planting stock fields must be completed. This information is not required for activities other than planting.		
Seedlot-Veglot	yes	The unique number (key) assigned to a quantity of seed of a particular species and quality from a given location collected at a given time. Seedlot-Veglot must exist in SPAR and be entered exactly as it exists in SPAR.
Species	yes	Code that represents the species of trees planted per the seedlot-veglot. See the RESULTS Technical Specifications to locate Species Code list.
Number Planted	yes	Total number of trees of the given seedlot planted.

Field	Required	Description and Conditions
Excess of Transfer Limit	conditional	Number of trees planted in excess of the seedling transfer limits described in the “Chief Forester’s Standards for Seed Use” at https://www2.gov.bc.ca/gov/content/industry/forestry/managing-our-forest-resources/tree-seed/legislation-standards/chief-forester-s-standards-for-seed-use Required when the trees planted exceed seedling transfer limits.
CBST Indicator	yes	A "Yes" or "No" indicator. Set to “Yes” if a seedlot-veglot is planted in an allowable Climate Based Seed Transfer (CBST) area of use as identified in the “CBST Areas of Use for British Columbia” document located at the Chief Forester’s Standards for Seed Use website at https://www2.gov.bc.ca/gov/content/industry/forestry/managing-our-forest-resources/tree-seed/legislation-standards/chief-forester-s-standards-for-seed-use Note: the CBST indicator field is not part of ESF schema. CBST will default to “No” for ESF submissions and can be updated to “Yes” online in RESULTS.

Table 9 Silviculture activities field specifications when reported by tenure summaries.

Field	Required	Description and Conditions
District	yes	District in which the cutting authority was issued.
Licence	yes	Licence number of the opening corresponding to the cutting authority. e.g., TFL49; A19204; W0012.
Fiscal Year Ending	yes	Date range identifying the dates within which the activities were completed.
Activity Base	yes	Code that identifies a primary category of silviculture treatment or activity. See the RESULTS Technical Specifications to locate Activity Base Code list.
Technique	yes	Code that identifies a general technique for accomplishing silviculture activity and may be a descriptor of the base activity. Depends on Activity Base. See the RESULTS Technical Specifications to locate Activity Technique Code list.
Method	yes	Code that identifies a specific method for accomplishing silviculture work and is a subdivision of technique. Methods describe a physical process for accomplishing work. Depends on Activity Base/Technique. See the RESULTS Technical Specifications to locate Activity Method Code list.
Funding Source	yes	Code that identifies the funding source for silviculture treatment. See the RESULTS Technical Specifications to locate Funding Source Code list. e.g., IA – industry appraisal; FIP – forest investment program administrated;
Treated Area	yes	The net area treated.

5.6.3 Attribute details

5.6.3.1 Activity treatment units

Treatments are reported by silviculture activity treatment units (ATUs). An opening can contain several silviculture ATUs, which can overlap. Each unit is reported as a separate silviculture activity within an opening.

5.6.3.2 Harvest and planting in the same reporting period

When harvesting completion and planting occur within the same reporting period, a disturbance report and a silviculture activity report are submitted. A forest cover report is submitted with the disturbance report. If the SU is satisfactorily restocked as a result of the planting activity, an additional forest cover report is submitted. If the SU remains NSR, no additional forest cover report is submitted.

5.6.3.3 Additional disturbances

See Section 5.4.3.5

5.6.3.4 Silviculture surveys

Submission of data pertaining to planning or completion of silviculture surveys is optional for licensees.

5.6.4 Spatial mapping data

Spatial data is optional for silviculture activity treatment unit reports for licensees.

5.7 Forest Cover Inventory Report

Forest cover inventory reports include attribute data (e.g., area, number of trees, tree species, tree species percent, damage agents, non-mapped components, etc.) and spatial data (e.g., spatial location, shape of the polygon, etc.) for each polygon in an opening. They are also referred to as "forest cover polygon reports". Forest cover attribute and spatial data are submitted through the ESF and can be viewed (attribute data only) in RESULTS.

Forest cover submissions and updates are a complete delete and replace. All polygons must be submitted whether they are being updated or not. Hence, each report for an opening includes: 1) all polygons within all Standards Units (as defined by FPPR s. 1(1)) for an opening; and 2) all polygons within the opening that are excluded from Standards Units (i.e., excluded from the NAR per FPPR s. 1(2)). Where the silviculture and inventory components do not differ, only the polygon and inventory components can be submitted; however, the inventory component also include Total Well-Spaced, Well-Spaced and Free Growing data.

The minister's information requirements for forest cover inventory as defined by FPPR s.1 are outlined in Section 5.7 and its subsections, and are summarised in **Table 10** through **Table 13** (inclusive).

5.7.1 Timing

Forest cover polygon information is submitted before June 1 for each area:

1. where harvesting has been completed prior to March 31 of that year;
2. that has met regeneration date requirements up to March 31 of that year;
3. that has not met regeneration requirements, but the regeneration date has passed prior to March 31 of that year;
4. that has met free-growing date requirements up to March 31 of that year;
5. where a free growing declaration has been made in accordance with FRPA 107 and FPPR 97; or,
6. that has not met free-growing date requirements, but the late free-growing date has passed prior to March 31 of that year.

Forest cover information submitted as part of a declaration for areas subject to requirements under FPPR 44 (4) is submitted no sooner than 12 months following the completion of harvesting.

No additional forest cover report is required if a forest cover report has been submitted together with a milestone declaration during the reporting period.

5.7.2 Attribute data

An opening can have one or more forest cover polygon reports. Each forest cover polygon report can have a non-mapped component, and one or more layers. Each layer can have one or more tree species, and one or more damage agents.

Four components comprise the forest cover inventory data in RESULTS: **polygon**, **inventory**, **silviculture**, and **non-mapped**. The polygon component is submitted for all polygon reports. The inventory and silviculture components are submitted for polygons within SUs. The non-mapped component accounts for areas that are removed from the NAR within a given polygon. Field specifications for forest cover attributes are in **Table 10** through **Table 13**.

5.7.2.1 Polygon component

Table 10 Forest cover "polygon component" field specifications.

Field	Required	Description and Conditions
Standards Unit ID	conditional	The SU associated with the forest cover polygon. Required if the polygon (including a reserve) is within a "Standards Unit" as defined by FPPR 1(1) and subject to "net area to be reforested" as defined by FPPR 1(2). NOTE: includes areas under FPPR 44(4)
Licensee ID	yes	Unique identifier for the forest cover polygon assigned by the licensee. In RESULTS, this field is referred to as Polygon ID. No duplicates permitted. e.g., 1, 2, 3; or X, Y, Z.
Area	yes	Gross area (ha) of the forest cover polygon. (Net area is derived by subtracting any non-mapped area.)
Reference Year	yes	Year the forest cover polygon data were collected. Less than or equal to the declared date when submitting with a declaration. For roads, reserves and other NP areas, the reference year may be different from the survey date and reflects the date the area was determined.
Re-entry Year	conditional	Year the next harvest entry is expected to occur in the opening. Applies to single tree selection in which a subsequent harvest entry is planned prior to the end of the rotational planning cycle.
Stocking Status	yes	Code representing the growing space occupancy relative to a pre-established standard. Status refers to whether the site has achieved those standards, according to the latest silviculture survey. Stocking status is most often described as not satisfactorily restocked (NSR), immature (IMM) or mature (MAT). In a multi-storied stand, select the code which describes the stocking status of the next layer to be harvested, the layer with the highest site occupancy. See the RESULTS Technical Specifications to locate Stocking Status Code list.
Stocking Type	yes	Code representing a sub-classification of the stocking status. In a multi-storied stand, select the code which describes the stocking type of the next layer to be harvested, the layer with the highest site occupancy. See the RESULTS Technical Specifications to locate Stocking Type Code list. E.g., artificial (ART), natural (NAT), plantable (PL), non-plantable (NPL).
Reserve Type	conditional	Code that identifies the spatial pattern of a reserve or retention area associated with a silvicultural system. Required if a <u>reserve</u> or a <u>retention area</u> is associated with the forest cover polygon. "G-Group" (a defined, mapped patch of residual trees) or "D-Dispersed" (a defined area within which are unmapped residual single trees or small clusters of trees are dispersed).

Field	Required	Description and Conditions
Reserve Objective	conditional	Code that identifies the reason for leaving the reserve. Required if Reserve Type = G or D. See the RESULTS Technical Specifications to locate Silviculture Reserve Objective Code list. Code for long term (full rotational planning cycle) <u>reserve</u> is any code other than "TIM". Code for <u>retention area</u> associated with a silvicultural system, in which the residual stems are available for a subsequent harvest prior to the end of the rotational planning cycle (e.g., second pass), is "TIM".
Site Index	conditional	Required if tree species are entered. For multi-storey stands, the SI is for the layer with the highest volume or next due for harvest (the layer with the greatest site occupancy, e.g., mature, pole, or sapling layer). For reserves, the SI may be based on previous stand information applied to the mature layer, or to the layer with the greatest site occupancy.
Site Index Source	conditional	Code representing the source or origin of the site index. Required if site index is entered. Use the most accurate method of collecting site index. See the RESULTS Technical Specifications to locate Site Index Source Code list. e.g., C – site index from site index curve; E – site index from SIBEC
Tree Cover Pattern	conditional	The spatial arrangement of residual patches of overstorey (layer 1). See the RESULTS Technical Specifications to locate Tree Cover Pattern Code list.

5.7.2.2 Inventory component

Table 11 Forest cover "inventory component" field specifications.

Field	Required	Description and Conditions
Layer	conditional	Code that characterizes a distinct canopy cohort within a polygon, containing a common forest cover structure with stems of similar ages and heights. Inventory component layers are: 1 (Mature), 2 (Pole), 3 (Sapling), and 4 (Regeneration) or I (non-layered, even-aged stands) If the polygon has multiple layers, the inventory component layer codes (1, 2, 3, and 4) are required depending on layers present in the stand. Refer to the Technical Specifications to locate the Layer code list.
Crown Closure	conditional	The percentage of ground area covered by the vertically projected crowns of the tree cover for each inventory component tree layer within the polygon. Required if tree species are entered.
Total Stems	conditional	Total number of live stems per hectare within the forest cover polygon, excluding germinants. Required if tree species are entered.
Basal Area	conditional	Required where basal area is >5m ² /ha or part of a stocking standard.
Species	conditional	The code(s) representing the tree species present within the polygon. Required if trees are present on the polygon that is associated with an SU. For the tree species code list, refer to the RESULTS Technical Specifications . Species may describe brush species in cases where stocking status is NCBR. Duplicate species are not allowed on the same label or layer. A maximum of ten (10) species can be reported.

Field	Required	Description and Conditions
Species Percent	conditional	Estimate of given inventory component tree species percentage within the polygon. The sum of all species in the inventory component must equal 100. Each species should be rounded to the nearest 1%. Required if species are entered in the inventory component.
Average Age	conditional	The reported age is an average of the inventory sample ages of the species. Regeneration delay surveys: Required for the leading species. Free growing surveys: Required for the leading and secondary species. Ages are optional for non-leading or secondary tree species.
Average Height	conditional	The reported height is an average of the inventory sample heights of the species. Height is expressed in metres to 1 decimal place. E.g., 4.1m Regeneration delay surveys: Required for the leading species. Free growing surveys: Required for the leading and secondary species. Heights are optional for non-leading or secondary tree species.
Damage Agent	conditional	Insect, disease, or other factor that has caused tree damage within the polygon. Required where damage agent is present within the polygon. Refer to the Technical Specifications for the Damage Agent Codes.
Incidence Percent	conditional	Percent of host species within the polygon impacted by the given damage agent. Required where damage agent is present within the polygon.
Incidence Area	conditional	Number of hectares affected by the given damage agent. Required where damage agent is present in a portion of the polygon.

5.7.2.3 Silviculture component

Table 12 Forest cover "silviculture component" field specifications.

Field	Required	Description and Conditions
Layer	conditional	Code that characterizes a distinct canopy cohort within a polygon, containing a common forest cover structure with stems of similar ages and heights. Silviculture component layers are: 1S (Mature), 2S (Pole), 3S (Sapling), and 4S (Regeneration). These are required if residuals comprise part of a stocking standard (e.g., Deviation from Potential (DFP), Single Entry Dispersed Silviculture System (SEDRSS), commercial thinning, or multi-storied stocking standards). For even aged and non-layered stands, use code "S". Refer to the Technical Specifications for the Layers code list.
Total Well Spaced	conditional	Total number of well-spaced stems per hectare, disregarding the M-value. Trees are preferred or acceptable species, and well-spaced using the minimum inter-tree distance in the stocking standards (as defined by the Standards ID). Required for all polygons within an SU, where well-spaced stems/ha are specified in the Site Plan or FDP/FSP. Not required for group reserves with no associated SUs, or for intermediate cuts with no regeneration obligations.
Well Spaced	conditional	Number of well-spaced stems per hectare, using the M-value. Trees are preferred or acceptable species, and well-spaced using the minimum inter-tree distance in the stocking standards (as defined by the Standards ID). Required for all polygons within an SU, where well-spaced stems/ha are specified in the Site Plan or FDP/FSP. Not required for group reserves with no associated SUs.
Free-growing	conditional	Number of free-growing stems per hectare, using the M-value. Free-growing trees are healthy, preferred, or acceptable species, well-spaced, free from inhibiting brush, and meet or exceed the required minimum height (if applicable). Greater than or equal to the minimum stocking standard if SU is declared free-growing. Required for all polygons within an SU, where well-spaced stems/ha are specified in the Silviculture Prescription or FDP/FSP. Not required for group reserves with no associated SUs.

Field	Required	Description and Conditions
Basal Area	conditional	Required for openings where basal area is part of a stocking standard.
Species	conditional	Code identifying the preferred and acceptable well-spaced species in the polygon. Required if preferred or acceptable well-spaced species are present on the polygon. Refer to the Technical Specifications for the Species code list. Duplicate species not allowed on the same label or layer. Species may describe brush species in cases where stocking status is NCBR.
Species Percent	conditional	Estimate of a given silviculture component species percentage within the polygon. Sum of all silviculture component species equal 100. Each species should be rounded to the nearest 1%. Required if species are entered in the silviculture component.
Average Age	conditional	The reported age is an average of the silviculture sample ages of the species. It is required for the leading silviculture species; it is optional for all other silviculture species.
Average Height	conditional	The reported height is an average of the silviculture sample heights of the species. It is required for the leading silviculture species; it is optional for all other silviculture species.

5.7.2.4 Non-mapped component

Table 13 Forest cover "non-mapped component" field specifications

Field	Required	Description and Conditions
Non-mapped Component ID	yes	Unique identifier for the non-mapped component defined by the licensee. Areas (e.g., rock or swamp) that should be taken out of the productive forest area – NAR – but should be accounted for.
Area	yes	Area of the non-mapped component in hectares.
Stocking Status	yes	Code representing growing space occupancy relative to a pre-established standard. Status refers to whether the site has achieved those standards. See the RESULTS Technical Specifications to locate Stocking Status Code list. Cannot be IMM or MAT.
Stocking Type	conditional	Code representing a sub-classification of the stocking status. See the RESULTS Technical Specifications to locate Stocking Type Code list) e.g., natural (NAT); unnatural (UNN); road (RD)

5.7.3 Attribute details

5.7.3.1 Forest cover components

Table 14 contrasts **polygon**, **inventory** and **silviculture** information.

Table 14 Forest Cover Components.

Component	Notes
Polygon	Polygon component. Required for all stands. Includes spatial (GML map). <i>Tracks general site information pertaining to the entire polygon.</i>
Inventory	Inventory component. Required for all polygons in an SU and recommended for treed polygons outside of an SU.
Silviculture	Silviculture component. Required for all polygons that reside within SUs. Report with corresponding inventory component.

5.7.3.2 Stratification

New polygons are created in the following cases (not a complete list).

- More than a 20% difference in leading species composition (e.g., Pl₈Sx₂ is separated from Pl₅Sx₅);
- Change in the leading species (e.g., Fdc₈Cw₂ is separated from Cw₆Fdc₄);
- Species composition changes from a mixed species to a pure stand (e.g., Fdc₁₀ is separated from Fdc₇Hw₂Cw₁);
- Any stratum that does not meet the required minimum stocking standard at the regeneration or free-growing time frames within the confines of FPPR s. 46.11;
- Any stratum that has more than the allowable number of countable stems/ha specified in a plan, prescription, or ministry policy;
- Any stratum with residual basal area retained (e.g., clear cut portion is separated from portion with residual basal area retained)
- Age difference between the leading inventory species in adjacent strata is 20 years or more;
- Height difference between the leading inventory species in adjacent strata is 10 m or more;
- Site index based on the leading inventory species in adjacent strata differs by more than 3 m; and,
- Different NP types (e.g., NP BR versus NP UNN).

If a forest cover type crosses an SU boundary, the forest cover polygon is divided into two polygons. Where an opening is not stratified into units smaller than SUs, the forest cover polygons are the same as the SUs that are identified for the opening.

5.7.3.2.1 *Minimum polygon size*

Recommended minimum polygon sizes for RESULTS spatial submissions depend on: 1) whether or not the polygon is associated with an SU, 2) the area of the SU (if applicable), 3) a polygon's stocking status, and 4) whether or not the report relates to a milestone declaration.

Recommended minimum polygon sizes are, for:

- SUs less than 1 ha, **the entire SU** for declaring milestones.
- SUs that exceed 1 ha, for declaring:
 - Post-harvest or regeneration milestones of an SU that is stocked or NSR: **1 hectare**
 - Free-growing date milestones of a free-growing SU: **1-2 hectare**
 - Free-growing date milestones of an SU that is not free-growing: **1 to 2 hectares**, provided the polygon is less than 5% of the SU NAR and is mappable.
- Classifying Reserves and NP areas. **0.25 hectares** (for mappable polygons)
- Polygons that are stocked or free-growing, and are not submitted as part of a free-growing declaration, where boundaries are:
 - recognizable and distinct on an air photo, differences in stand type are classified to a minimum polygon size of **2 hectares**; or,

- not recognizable and distinct on an air photo, differences in stand type are classified to a minimum polygon size of **5 hectares**.

5.7.3.3 Multi-layer stands

If the stand is even-aged and single-layered, then only one layer of forest cover information is reported in the silviculture (S) and inventory (I) components.

If the stand is multi-layered, then up to four layers of forest cover information are reported for the silviculture and inventory components.

If a polygon has $>5\text{m}^2/\text{ha}$ basal area and a regeneration obligation, it must be reported as a multi-layered stand.

5.7.3.3.1 Residuals

For multi-layer stands, or stands with long term reserves or short-term retention, the area from which timber is removed is referred to as "denuded" (or "harvested") portion of the stand. Any remaining retained trees are referred to as "residuals". The forest cover attributes for both the denuded portion and residual portion of the stand are reported using the forest cover multi-layer fields.

5.7.3.4 Reserves, roads, and other mapped features

Distinct forest cover polygons are created for reserves, roads, and other mapped features within an opening. These polygons are associated with an Opening ID, and they must align with the Opening Definition boundaries.

5.7.3.4.1 Reserves fields

Reserves are forested patches or individual trees retained during harvesting, or other forestry operations, to provide habitat, scenic, biodiversity, and other values. These areas or trees are usually retained for one or more rotations. The RESULTS "Reserve Type" and "Reserve Objective" fields are used to classify residuals in both long term reserves and residuals left for less than a rotation as part of a silvicultural system. Refer to [Submitting Forest Cover to RESULTS for Openings with Treed Retention](#) for further details on reporting reserves.

Reserve Type refers to the spatial pattern of the residuals: "Group" or "Dispersed".

- **"Group"**: a defined, mapped patch of trees, does not have NAR.
- **"Dispersed"**: trees that are retained individually or in unmapped groups (e.g., small clusters <0.25 ha), but are enclosed within the boundaries of the mapped polygon designated as "dispersed reserve"; has NAR.

Reserve Objective refers to the management goal of the retained trees. Residuals left as part of a silvicultural system are distinguished from residuals left as part of a reserve. Reserves that are constrained for an entire rotation are assigned reserve objective codes according to the primary constraining objective, e.g., Wildlife tree retention (WTR), Riparian reserve (RMA), or any objective other than timber management "TIM". Retained trees not associated with a long-term constraint are assigned the objective of

TIM and are modeled as contributing to future timber supply whether or not a second harvest entry is scheduled or planned.

Reserves within which harvesting has occurred (e.g., dispersed reserves) are associated with an SU. In this case, polygon, inventory, and silviculture component information is required.

Group reserves do not have associated silviculture responsibilities and are mapped and reported. Silviculture and inventory components information are not required in this case. Only polygon components are submitted where the pre-existing vegetation inventory label will be used for vegetation update process. If a group reserve with an inventory component is provided, it will be used to update vegetation inventory.

E.g., If a polygon is assigned a reserve objective "TIM", then the forest cover pertaining to a "mature" layer or "pole" layer within that polygon is considered to be part of a silvicultural system that features some kind of retention of residuals (e.g., residuals for a seed tree silvicultural system, single or group selection, retention system, shelterwood, patch cut, etc...). These residuals are considered to be available for harvesting during a future cutting cycle prior to the end of the rotation; whereas residuals left as part of a reserve are considered to be not available for harvest until the end of the rotation.

5.7.3.4.2 Tracking reserves

Group reserves are often reported as even-aged. Residual stems comprise the entire reserve. Report the layer with the most significant site occupancy (often the "mature" layer).

Report the best information available for the residual stems in a group reserve outside of the NAR. If recent survey (including ocular estimates) or timber cruise information is not available (it is not a cruising requirement to survey the residual component of reserves), report forest cover information from the existing inventory label, citing the appropriate reference year.

Dispersed reserves are reported as multi-layer stands where the level of dispersed retention (residual trees) is $> 5\text{m}^2$ per hectare of residual basal area and are associated with an SU. Within a polygon, the inventory component is reported for the overstorey residual stems and the inventory and silviculture components are reported for the denuded portion. .

5.7.3.4.3 Mapping Reserves

Group Reserves 0.25 ha or greater: Group reserves equal to or greater than 0.25 ha are mapped, including fully external reserves.

Dispersed Reserves: Dispersed reserves are mapped as part of a standards unit. Any density of dispersed retention is included within a standards unit.

Reserves less than 0.25 ha: Reserves from 0.1 to 0.24 ha, are tracked. If the exact locations of these reserves are mapped, they may be reported as individual "Group" reserves. If the exact locations of these reserves are not mapped, they are reported as "Dispersed" reserves within an SU, and the polygons within which they are located are mapped, although the individual trees themselves are not mapped.

5.7.3.5 Non-productive areas

Forest cover reports for non-productive areas, including roads, include Polygon ID (or Non-Mapped Component ID if the NP area is not mappable), area, stocking status, stocking type, and reference year (see Section 5.7.3.5.1). If species is recorded, age and height are also recorded (inventory component only). Remaining forest cover data is optional. Once reported at harvest, the reference year is the same at regeneration delay, and free-growing if stocking status has not changed. Non-productive areas, including roads or temporary access structures, that meet the minimum polygon size are mapped.

5.7.3.5.1 Roads

Permanent and temporary access structure (and other temporary structures such as landings) are reported in one of two ways:

- 1) Permanent Access Structure: as (NP-RD), may be reported spatially, or as a non-mapped area;
- 2) Temporary Access Structures; as (NP-UNN), may be reported spatially, or as a non-mapped area. Please note that the stocking status of the temporary access structure may change from unproductive (NP-UNN) to NSR or IMM through the lifecycle of the opening as the road becomes rehabilitated and trees re-established.

5.7.4 Spatial mapping data

Figure 9 shows examples of SU to forest cover relationships.

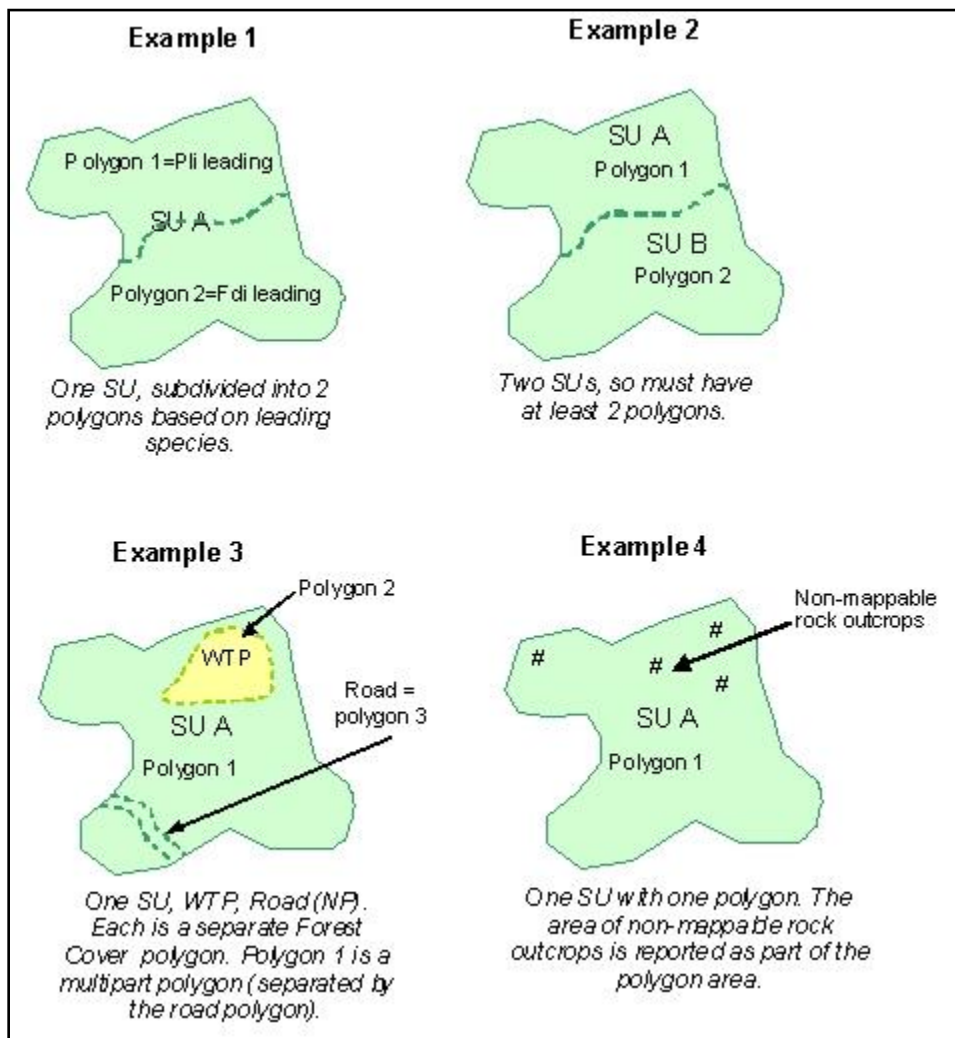

Figure 9. Examples of SU to forest cover relationships.

The following figures show various forest cover configurations.

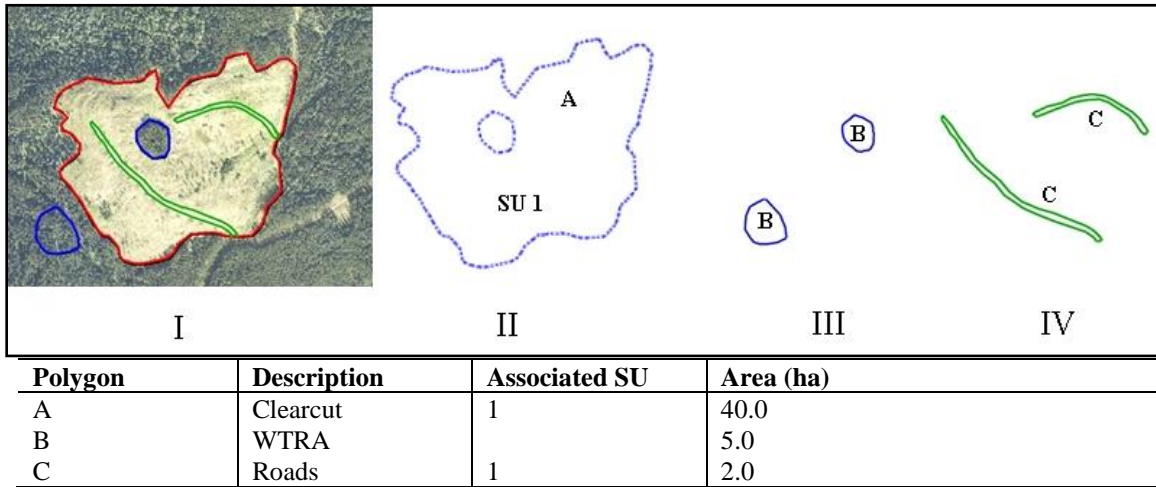

Figure 10. Opening comprised of three forest cover polygons.

II) The productive area (NSRNAT), a polygon with an internal hole. III) A multi-part polygon for the reserves (MATNAT). IV) A multi-part polygon for the temporary access roads (NPUNN).

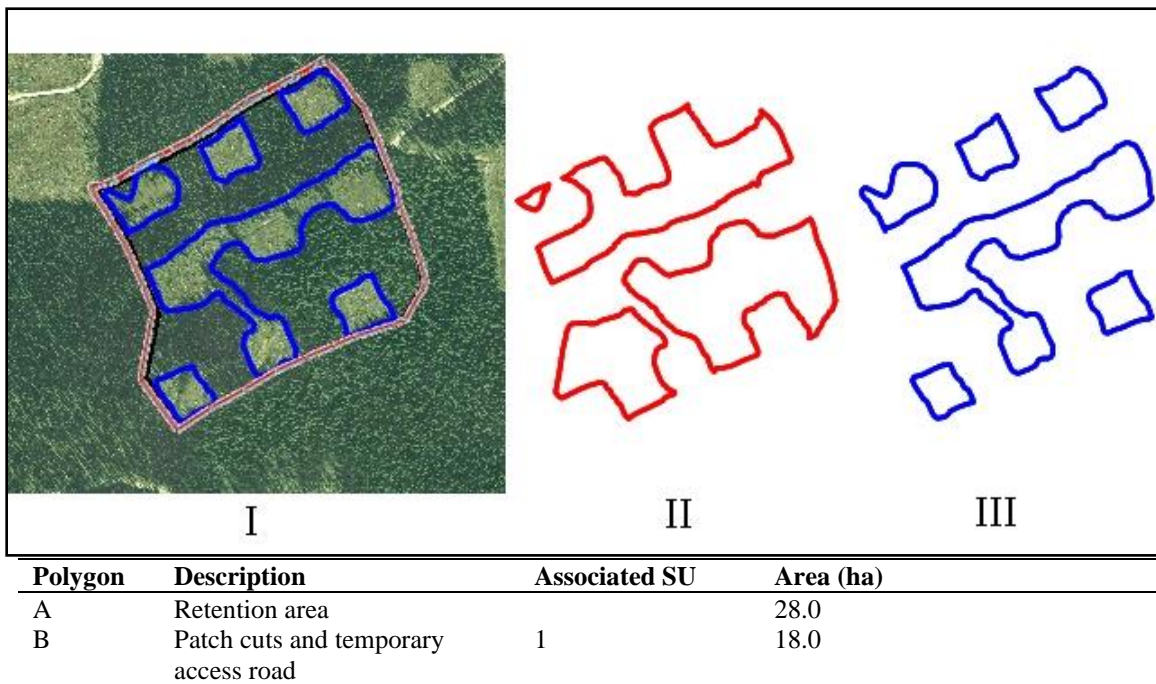
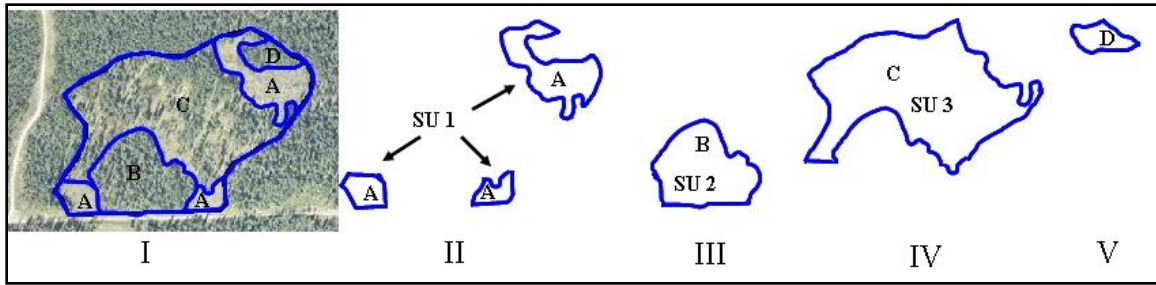

Figure 11. Opening is a multi-pass silvicultural system with a planned re-entry.

Comprised of patch cuts with a surrounding retention area that will be available for a second pass. Two multi-part forest cover polygons are included. II) The first polygon represents the unharvested retention (MATNAT). The retention is classified as a Group Reserve with a TIM objective because it is subject to being available for a second pass harvest prior to the end of the rotation (whether or not it becomes harvested). III) The second polygon represents the harvested patches (NSRNAT) including the temporary access road which, in this example, will be fully rehabilitated to the standards of SU1.



Polygon	Non-Mapped	Description	Associated SU	Area (ha)
A	NPUNN	Temporary Access Road		0.2
A		Clearcut (upper) and 2 Landings (lower)	1	9
B		Single Tree Selection	2	10
B	NPUNN	Temporary Access Road		0.2
C		Group Selection	3	19.5
C	NPUNN	Temporary Access Road	3	0.3
D		WTRA		2

Figure 12. Variable retention opening.

Each distinct silvicultural system is associated with a separate SU. The discernible main road at the bottom of the photo is part of a permanent road under a Road Permit and is not reported for this example. Other small temporary road segments in this example (not discernible on this photo) are tracked as non-mappable components of the polygons.

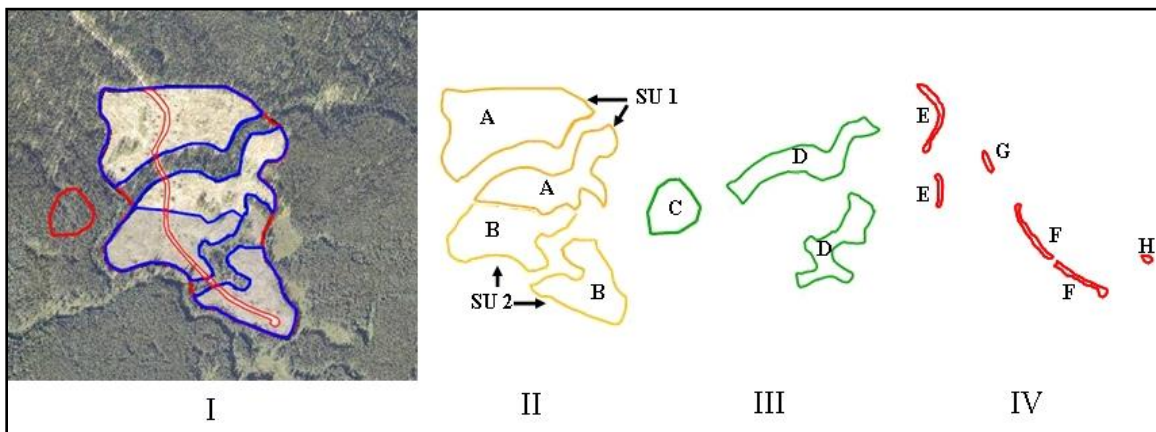

Polygon	Description	Associated SU	Area (ha)
A	Seed tree	1	19.0
B	Clearcut	2	21.0
C	WTRA 1		4.0
D	WTRA 2 & 3		6.0
E	Roads for SU 1	1	1.2
F	Roads for SU 2	2	1.0
G	Roads for WTRA 2	1	0.5
H	Roads for WTRA 3	2	0.3

Figure 13. Opening divided into multiple forest cover polygons based on SUs, roads, and WTRAs.

II) Two multi-part polygons representing SUs 1 and 2. III) Polygon C represents the external WTRA (significantly different from the internal WTRAs; therefore, not grouped). Polygon D represents the internal WTRAs. IV) Roads. The roads that pass through the WTRAs are associated with the SUs to which they are most proximal. In this case the road G for the upper WTRA 2 will be rehabilitated to the standards of SU 1. The road H for the lower WTRA 3 will be rehabilitated to the standards of SU 2.

5.8 Milestone Declaration Reporting

Free-growing milestone declarations are mandatory under Bill 23- Forest Statutes Amendment Act Section 77. Licensees may declare that they have achieved any of the following milestones: post-harvest, regeneration, or no-regeneration (for intermediate cuts subject to FPPR s. 44[4]).

By declaring that a **free-growing** milestone has been met, licensees are, before further examination by the ministry, deemed to have met the obligation. Milestone declarations must be accompanied by current forest cover reports (with attribute and spatial data) for the areas that are being declared.

Declarations can be made either as a submission to RESULTS through ESF, or as an online update within RESULTS.

5.8.1 Attribute data

Attribute field specifications are listed in **Table 15**.

Table 15 Milestone declarations field specifications.

Field	Required	Description and Conditions
Standards Unit ID	yes	SU to which the milestone declaration relates.
Declaration Date	yes	Date the declaration is made by the licensee (or BCTS if applicable) official. May not necessarily be the same as the submission date. If an opening has early and late free-growing offsets, the free-growing declaration date should be equal to either of, or between, the early and late free-growing dates. A FG declaration is not made prior to the early free-growing date of the Stocking Standard.
Milestone Type	yes	See the RESULTS Technical Specifications to locate Milestone Type code list. e.g., FG – free-growing; RG – regeneration; PH – post harvest; NR – No Regeneration.
Declared to the Extent Practicable (DEP) indicator	Conditional	A "yes" or "no" indicator. Set to “yes” if the free-growing milestone is being declared to the extent practicable in accordance with FPPR s.97.1.
Comment	Optional	A submitter who is not an RPF may use the comment field to enter the Name of the Registered Professional Forester responsible for assessments related to the official declaration. To indicate that FPPR 46.11(2)(b) applies, pertaining to section 86(3)(d)(iii), please add “46.11(2)(b)” as a comment.

5.8.2 Attribute details

5.8.2.1 Electronic signature

FRPA s.107(2) requires the license holder, or a person authorised by the license holder to make declarations, to sign the declaration. An electronic milestone declaration submitted using a BCeID is considered an electronic signature. Users with RESULTS Declaration authority can submit milestone declarations.

5.8.2.2 Supporting documentation

5.8.2.3 Declarations by standards unit

Milestone declarations are submitted individually for each Standards Unit (SU) in an opening. SU identifiers correspond with those in the opening definitions existing in RESULTS. After all SUs in the opening have been declared free-growing, the Opening Status is automatically updated to FG-Free-growing.

5.8.2.4 Milestone due dates

Milestone due dates are tracked in RESULTS based on the information submitted with the opening definition. Due dates are displayed as the number of years from the commencement of harvest. Due dates are blank for post-harvest, given no requirement to submit post-harvest milestones for openings other than partial cuts or other intermediate cuts. The commencement date for obligations is initiated by disturbance reporting which is based on Opening Category. Commencement date for:

- **Current forest tenures (FTxx)**, is initiated by the disturbance reporting (harvest start date usually, but harvest end date in the absence of regeneration obligations);
- **Natural disturbances (NDxx)**, is initiated by the opening approval date;
- **Backlog areas (BLxx)**, is initiated by the completion of the first non-survey silviculture activity.

5.8.2.5 Forest cover updates

A current forest cover update is required when a milestone declaration is submitted [FPPR s. 97(7)]. It can either be submitted together with other reports during the reporting period, or in the same submission as the milestone declaration.

5.8.2.6 Post-harvest milestone declaration

Post-harvest milestone declarations may be used to declare the completion of harvest and soil rehabilitation activities associated with soil disturbance or access structures rehabilitation for any silvicultural system.

When post harvest has been declared on all SUs in an opening, the FTA cutblock status for the opening automatically changes to S-Silviculture if it is not already set to that status. Post-harvest declarations may be submitted after the completion of harvest activities.

5.8.2.7 No-Regeneration milestone declaration

No-Regeneration milestone declarations may be used to declare that no outstanding silviculture obligations exist on a polygon to which FPPR s.44(4) applies (e.g., for partial cutting or other intermediate cuts such as commercial thinning, harvesting poles, or sanitization). No-Regeneration milestone declarations are submitted no sooner than 12 months following the completion of harvest activities.

6 Spatial Data Format

Spatial data submitted to RESULTS are formatted according to standards in this section.

6.1 General Mapping Standards

6.1.1 Scale

Base map is 1:20,000. Map boundaries originate from a 1:20,000 (or greater) map scale. This scale corresponds with the scale of the Terrain Resource Information Management (TRIM) map base. A map scale greater than 1:20,000 (e.g., 1:10,000 or 1:5000), does not increase the positional accuracy of the spatial data with respect to the TRIM or Vegetation Resources Inventory (VRI) map.

6.1.2 Position

Maps are checked for positional accuracy with 1:20,000 TRIM maps, and/or Vegetation Resources Inventory (VRI) maps.

6.1.3 Accuracy

At the 1:20,000 scale, polygon boundaries must be within one millimetre of their true North American Datum of 1983 (NAD83) map location (within 20 m of their true location) (Figure 14). One tie point must be established within 10 m of its true NAD83 position for all traversed boundaries.

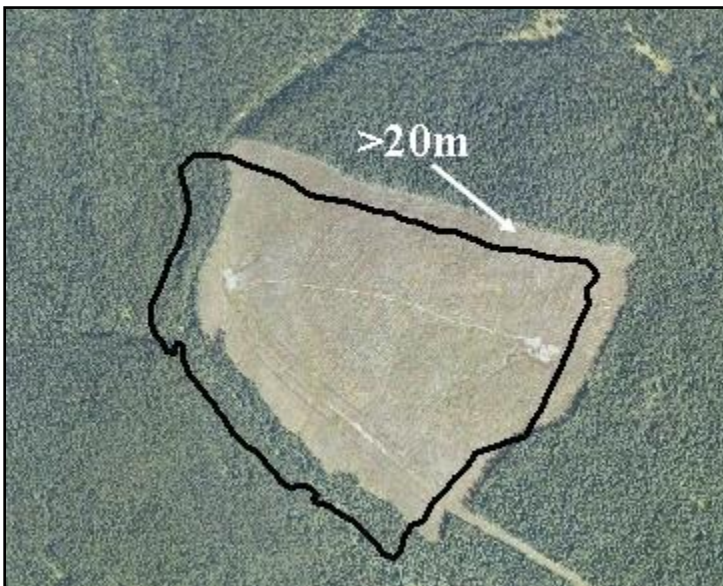

Figure 14. Relative positional accuracy overlay.

This polygon is greater than 20 m from its true location. This submission would fail.

The ministry considers (with few exceptions) more recent opening spatial data submitted through the ESF to be more accurate, and better positioned, than spatial data for older openings. This is noteworthy in situations where, for example, a recently submitted

opening definition that was GPS traversed overlaps a historical opening that was hand traversed and may not be as well positioned, nor as accurate.

6.1.4 Minimum resolution

Minimum resolution refers to the degree to which closely related features can be distinguished. Linear features (e.g., roads) should not be less than 10 m apart (some GIS systems have difficulty processing smaller resolutions).

6.1.5 Units

The hectare (ha) is the acceptable unit.

6.1.6 Tolerance for differences between attribute and spatial area data

The tolerance for differences in area between what is submitted within the attribute data and what is calculated from the spatial data is dependent on the size of the opening. For openings less than 20 ha, the attribute data and the spatial data must be within the lesser of 1 ha or 25% of the opening size. For openings greater than 20 ha, the attribute data and the spatial data must be within 5% of the opening size.

6.2 Multi-part Geometry

Polygons, lines, and points are components of spatial information structure. In e-Submissions, these simple geometries are extended to include multiple parts and internal holes.

Multi-part geometry allows for a single feature (such as an SU) that is represented by two spatially isolated polygons, to be represented in GML as a multi-part polygon. Multi-part geometries are used to represent a single feature where gaps exist between some of the feature parts. Multi-part polygons in GML *are not* structurally the same as utilizing two polygons to represent a given feature. Attributes are stored only once in a submission for any given feature represented by a multi-part geometry (i.e., a single SU that occurs in different parts of an opening [see **Figure 15**]). If a single feature is represented by two polygons (e.g., one SU described spatially by two polygons with duplicate attributes), **the RESULTS submission will fail.**

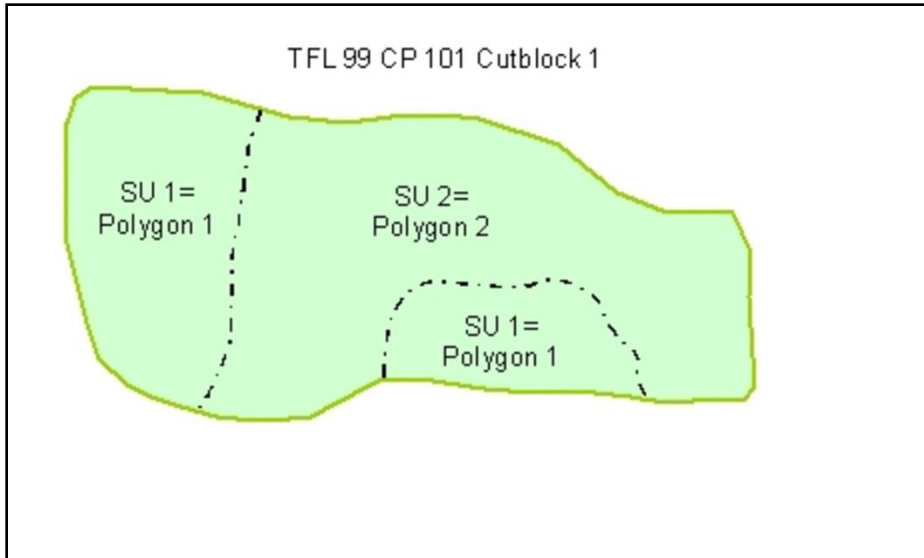

Figure 15. Multi-part geometry.

This opening (CP 101 Block 1) is represented by a multi-part polygon for SU1 and a simple polygon for SU2, not by three separate polygons.

6.3 Spatial Topology

Topology refers to the structure and rules applied to create valid geometric objects that are usable by the government for various analyses.

6.3.1 Polygon topology

A polygon is a closed shape that has a starting point equal to its end point and is comprised of a minimum of three points or vertices (Figure 16).

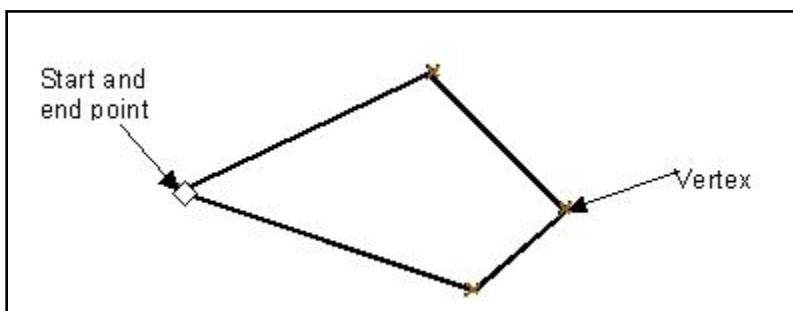

Figure 16. A polygon.

A closed polygon has exactly the same coordinate for the start and end points. The start and end point coordinates of each line forming the polygon match exactly. Lines forming the polygon cannot overlap and the point of intersection is where the start and end points meet (i.e., no gaps, or overshoots as in Figure 17).

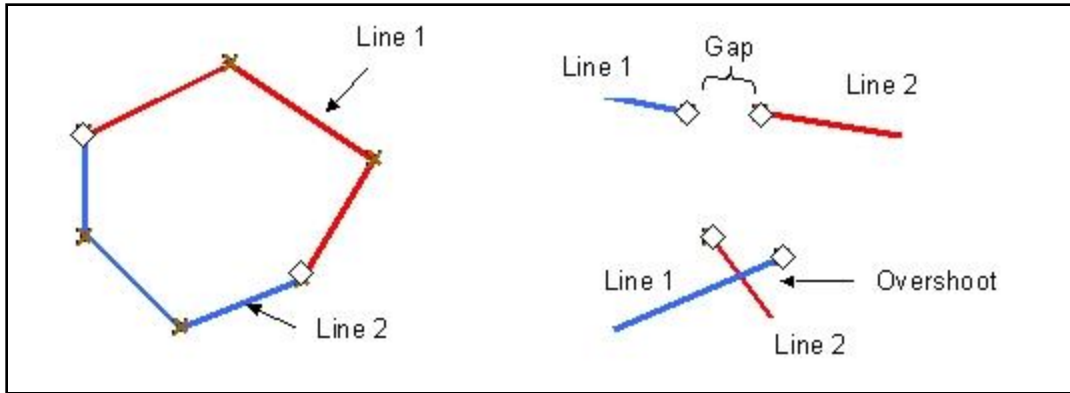

Figure 17. Unacceptable polygon lines.

The order of polygon vertices is commonly set to flow clockwise (**Figure 18**). This ensures that the inside of the polygon is always along the right side of a line, often referred to as the “right-hand rule,” and helps identify the inside and outside of the polygon. This rule is also applied to polygon holes.

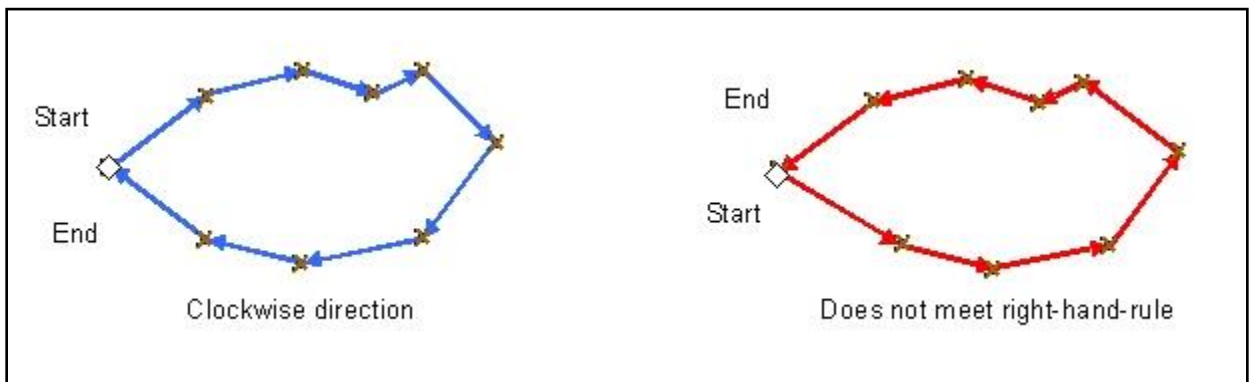

Figure 18. Right-hand rule for polygons.

Where an internal hole is required within a polygon, such as a new opening that surrounds another previously submitted opening, the spatial data must utilize internal rings or polygons to encode the “donut holes” in the spatial information (**Figure 19**) because GML uses linear rings to represent internal polygon holes.

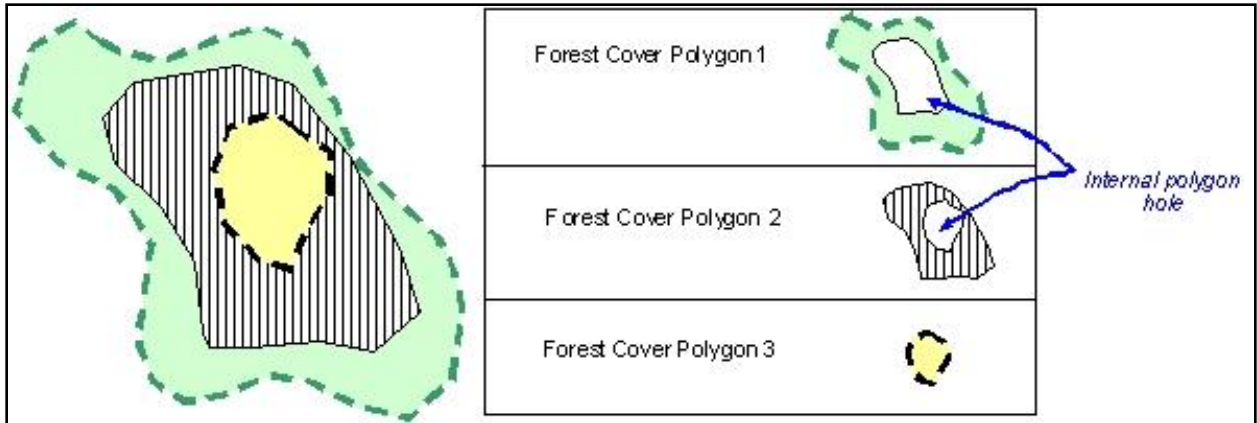

Figure 19. Features cannot overlap.

Where a polygon feature exists fully within another polygon, an internal hole must be created in the larger polygon. Here the opening consists of three forest cover polygons. The area covered by forest cover polygon 1 must not include the area covered by forest cover polygon 2 so an internal hole is created. Similarly, forest cover polygon 2 must not include the area covered by forest cover polygon 3 so another internal is created.

6.3.2 Linear topology

Lines are simple structures, consisting of a starting point and, at a minimum, an end point. Direction of a line is determined by the location of starting and end points (Figure 20).

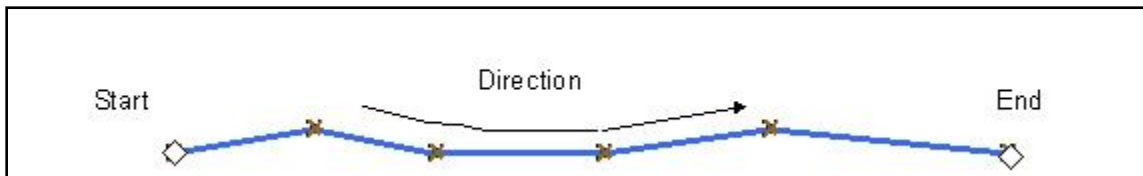

Figure 20. Line direction.

When creating directional information, ensure that lines do not intersect (**Error! Reference source not found.**).

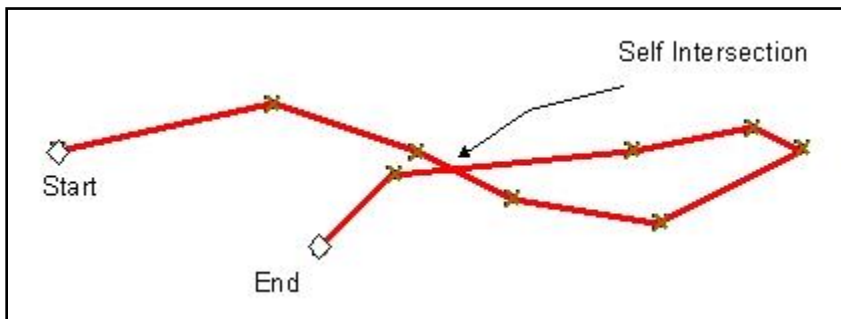

Figure 21. Lines must not intersect.

A line that intersects itself likely signifies that two separate lines are required (Figure 22).

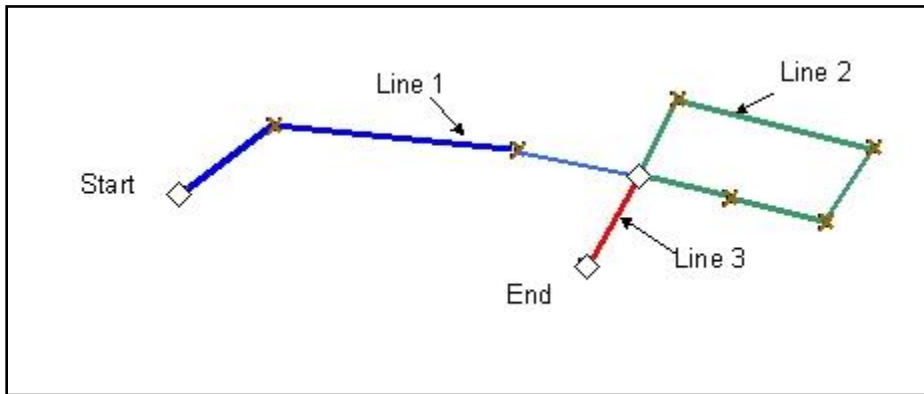

Figure 22. Separate lines.

6.3.3 Common topology complexities

Spikes and overlapping features are common in spatial data.

6.3.3.1 Spikes

Spikes may be formed during data preparation. Spikes are portions of lines or polygon edges that form sharp angles among three vertices (**Figure 23**). Spikes become individual polygons when automatically processed in many geographic information systems (GIS) or spatial processing systems. Vertices should be readjusted to eliminate spikes.

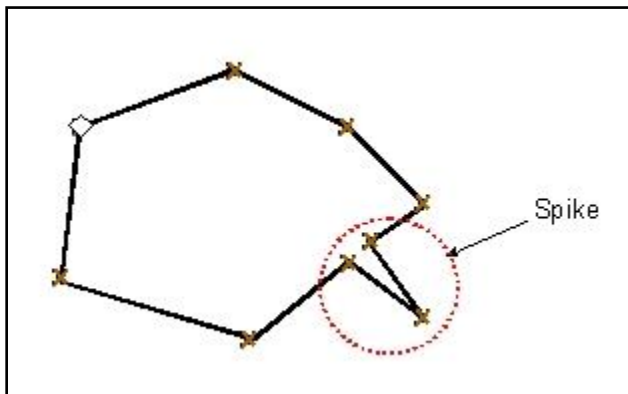

Figure 23. Polygon spike.

6.3.3.2 Overlapping features

In multiple geometrics, overlap can occur (Figure 24) and small slivers are formed between geometrics. Where features follow a shared boundary, the vertices must be identical in both geometrics to ensure no slivers or overlaps occur.

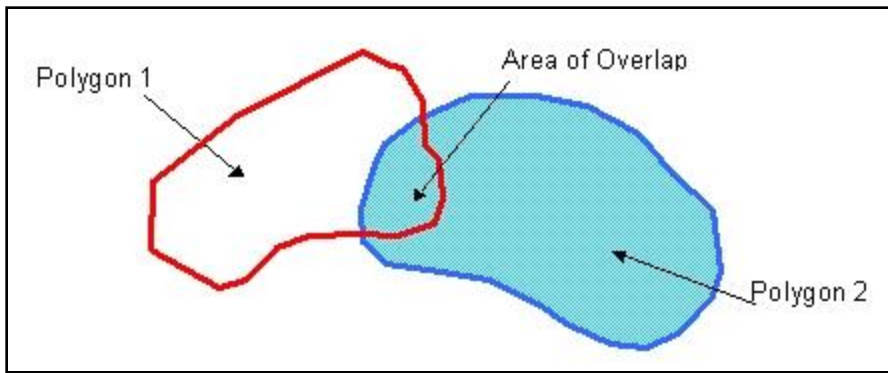

Figure 24. Polygon overlap.

When formatting shared boundaries, the same lines (a copy) should be used to form a boundary between features (**Figure 25**).

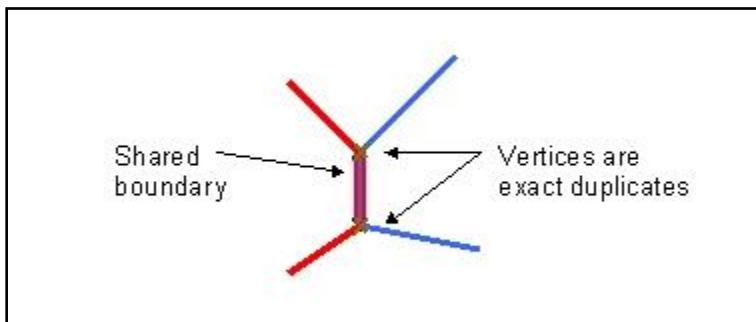

Figure 25 Shared boundary.

6.3.4 Spatial data validations

Data that break standard topology rules such as self intersecting lines are rejected. To avoid rejected submissions, data cleaning processes should be applied before submission. Most GIS software have tools to detect and clean these conditions.

The FOR has upgraded to a spatial database technology with increased data resolution. The new model is based on a tolerance of 0.005 meters or ½ of a millimetre. Any two coordinates or any coordinate and a line segment within this tolerance range represent noise in the data and are considered invalid. RESULTS 3.0 cleans invalid data within this tolerance range without changing the topology by:

1. Automatically removing duplicate points. This does not change the topology of the data (**Figure 26**).
2. Removing spikes in cases where the spike represents 1 mm or less on the ground. (Nothing can be mapped to 1mm on the ground) (**Figure 27** and **Figure 28**).

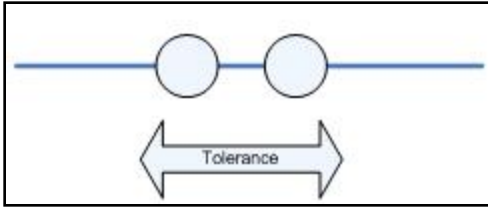

Figure 26. Duplicate points.

The two coordinates are closer together than ½ millimetre. Another common case is two completely coincident points. A "weeding" algorithm with an appropriate tolerance eliminates duplicate points.

Intersections occurring within one polygon have historically been limited to line work which crosses itself. When a tolerance range is introduced to this validation, the lines need not cross to be considered intersecting; they need only interact within the tolerance specified.

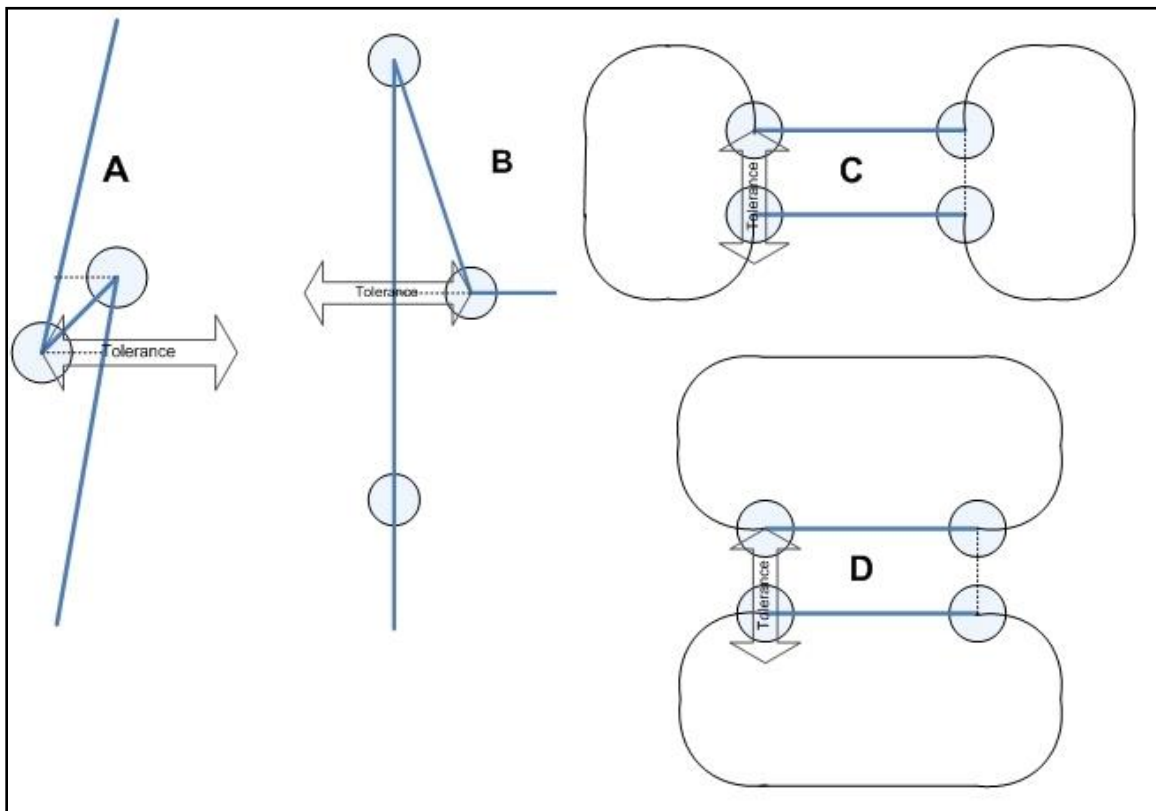

Figure 27 Self Intersecting Polygons.

A: Situation where a vertex (blue) is less than the tolerance distance away from another line segment. The dashed line shows the offending vertices. These situations can be detected with most GIS software and conversion tools. Often caused by digitizing jitter or GPS noise that is not cleaned after data capture. **B:** Similar example where the offending vertex is less than the tolerance distance away from another line segment. **C:** A polygon where a very narrow area (less than or equal to the tolerance) connects what appears to be two separate polygons. **D:** A multi-polygon where the two polygon components are separated by less than the tolerance distance. Likely intended to be a single polygon.

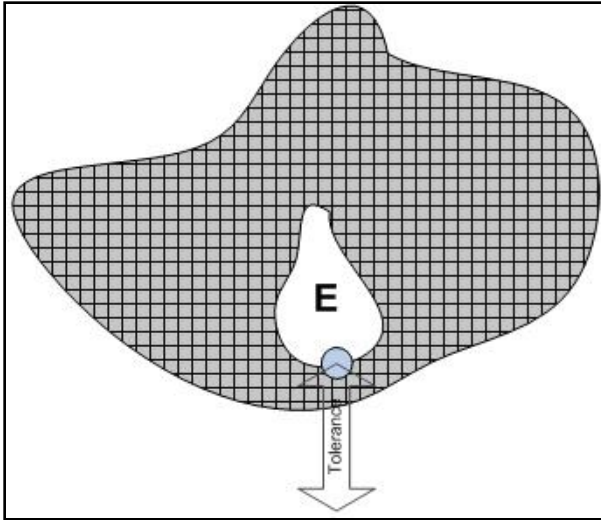

Figure 28. Self intersecting polygons.

E: Vertex in a polygon hole is less than the tolerance distance away from the exterior ring. Similar to examples C and D in Figure 27, applied to a different situation.

6.3.5 Topology

In Figure 29, Polygon A is formed by lines 1, 2, and 4 because they have the same level, line weight and colour (other factors can be used to relate lines into polygons). Polygon B cannot be created because colour, line weight, and level cannot be related to form a polygon. Polygon B is difficult to determine, despite that it “looks” right, given that line 3 is on a different level from all other lines.

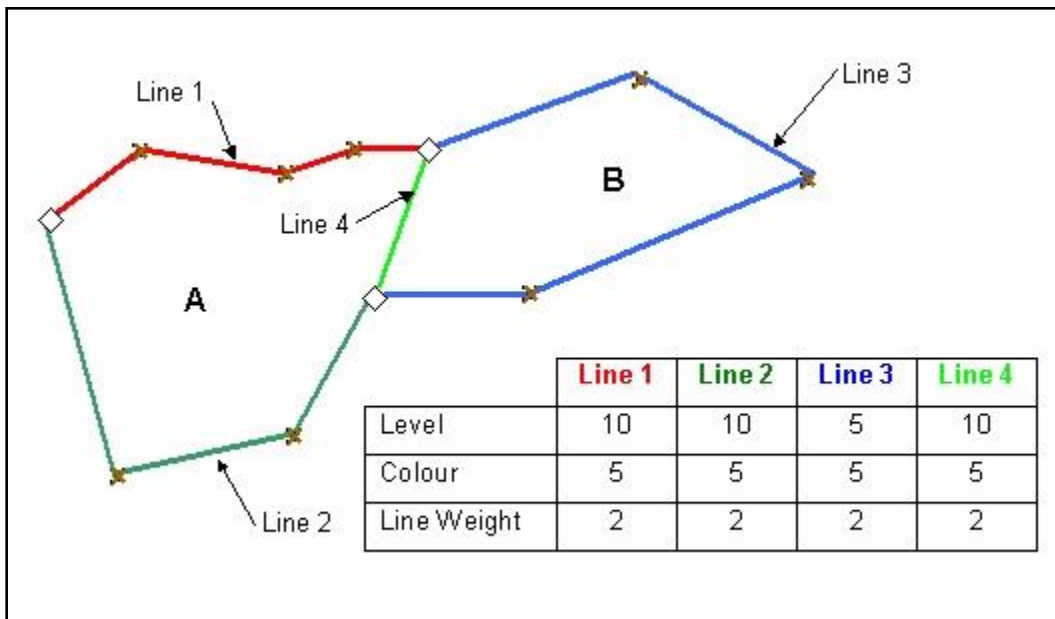

Figure 29. Polygons can be represented by using proper structure.

6.4 Spatial Projections

Three general types of spatial projections are supported: Geographic (Latitude/Longitude), Universal Transverse Mercator (zone 7, 8, 9, 10, 11 in metres), and Albers Equal Area (BC Standards). For e-Submission documents, the projection information is defined for each spatial object.

7 Precision Standards

Precision standards identify the maximum differences allowed between licensee and ministry estimates of a forest inventory/forest cover attribute or stratification. The precision standards are measured by determining the difference between the data reported by the licensee and data collected from a ministry survey of the same area. The ministry may consider differences between the licensee estimate and the ministry estimate of an attribute that exceed the required precision standard, as being in non-compliance with form and manner specifications (FPPR s.86[6])

The following minimum precision standards apply to forest inventory and forest cover data submissions to RESULTS (Table 16). These standards should not be confused with FIA or contract management standards.

Table 16 Minimum precision standards for data submissions.

Forest Inventory Attribute	Precision Standard for Data Submissions	Comment
Inventory species composition	Only trees identified as commercial tree species may be included in the composition. Must correctly identify the leading species. Estimate of individual species composition percentages must be within 20% of the ministry estimate.	
Silviculture species composition	Only trees identified in the applicable stocking standards for the SU may be included in the silviculture species composition. Estimate of individual species composition percentages must be within 20% of the ministry estimate.	
Total trees/ha	± 20% of the ministry estimate	
Well-spaced or free-growing stems/ha	± 10% of the ministry estimate	
Estimated stand age	± 20% of the ministry estimate	
Estimated tree heights	± 20% of the ministry estimate	
Site index	± 3 m of the ministry estimate	
Pest infection	Absolute difference ≥10% in the estimate of pest incidence between the reported and ministry estimate is unacceptable.	e.g., an unacceptable difference is where the reported estimate of pest incidence is 2% and the ministry pest incidence assessment is 13%.