

Ministry of
Housing and
Municipal Affairs

2024 BC BUILDING CODE ADAPTABLE DWELLING UNIT ILLUSTRATIVE DESIGN GUIDE

 **GHL**
CONSULTANTS LTD
Building Codes & Fire Science

X **public**

2025.03.14

TABLE OF CONTENTS

	Page
Acknowledgments.....	ii
Preface.....	ii
Legend.....	iii
Clear Floor Space Legend.....	iii
1.4.1.2. Defined Terms.....	1
3.8.5.1. Application.....	2
3.8.5.2. Construction Requirements.....	4
Adaptable Dwelling Unit Provisions Table.....	5
3.8.5.3. Building Access Requirements.....	6
3.8.5.4. Adaptable Dwelling Unit Doorways.....	7
3.8.5.5. Adaptable Dwelling Unit Hallways and Corridors.....	10
3.8.5.6. Adaptable Dwelling Unit Bedrooms.....	12
3.8.5.7. Adaptable Dwelling Unit Bathrooms.....	15
3.8.5.8. Adaptable Dwelling Unit Kitchens.....	23
3.8.5.9. Controls, Switches and Outlets.....	26
3.2.4.19.(7) Special Outlet for Future Strobe.....	27
Adaptable Dwelling Unit Plans.....	29
Adaptable Floor Plate Example.....	33

Acknowledgments

We extend gratitude to the local governments, development industry professionals, accessibility advocates and other interest holders who contributed their input to inform the development of the Adaptable Dwelling Unit Illustrative Design Guide.

This guide was developed by Lucas Genereux, ASCT and Andrew Harmsworth, M Eng, P Eng, CP, FEC at GHJ Consultants Ltd. with illustrations created by John Wall, Architect AIBC, RAIC, Shane O'Neill, Architect AIBC, RAIC, Sergio Mancini, Architect and Urban Planner Licensed in Brazil, and Catherine Wong, Intern Architect, AIBC at PUBLIC Architecture + Design Inc. in partnership with Ministry staff from the Building and Safety Standards Branch.

We acknowledge with gratitude that this guide was produced on the traditional unceded territories of the xʷməθkʷəy̓əm (Musqueam), Skwxwú7mesh (Squamish), and səilwətaʔ/Selilwitulh (Tsleil-Waututh) Nations, we respectfully honour their cultures and traditions and all the unique Indigenous Peoples and Nations across the province.

Preface

Adaptable dwellings help people through every stage of life. Not only do they provide adaptable housing for people living with disabilities, they also help those experiencing life changing illnesses or temporary or permanent injuries, multigenerational families, and seniors who may wish to age in place. Adaptable dwellings provide accessible entrances, more clearance space to support mobility, accessible controls, switches, and features to suit occupants' needs, offering greater comfort and accessibility.

The BC Building Code (BCBC) provisions have been enacted in the context of and in alignment with the 2020 National Building Code (NBC) research that reflects how people interact with the built environment. The [Accessible British Columbia Act](#) was passed in June of 2021, with the commitment to prioritize more accessible homes, buildings, infrastructure and public spaces and support people with disabilities to meaningfully participate in their communities.

The adaptable dwelling unit requirements of the 2024 BCBC aim to reduce future retrofitting costs and help people to stay in their homes through illness, injury, and aging. This guide is intended to be a complementary resource to the Space and Cost Impact Report Study to support implementation of the 2024 BCBC adaptable dwelling unit and earthquake requirements.

The illustrations and commentary within this guide should not be read as legal interpretations of the BCBC requirements. This design guide offers suggestions and considerations for the design community and does not replace formal Code education or the legal language within the 2024 BCBC. Accessible and adaptable spaces should be designed by qualified individuals who have been properly trained on accessible and adaptable building systems and design. The Building Code establishes the scope and application of the design guide content.

Legend

To assist with content identification in this design guide, the following legend describes the conventions used to display the 2024 BCBC language, commentary, and clear floor space illustrations.

Black Text – 2024 BC Building Code provisions

Italicised Text – Defined terms in the 2024 BC Building Code

 – References to code sections outside 3.8.5 / Notes to Part 3

 – Design guide notes and commentary

Clear Floor Space Legend

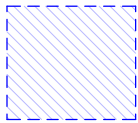

Door – Pull Side: 1500mm by 1700mm with 600mm beside latch

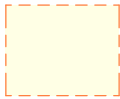

Door – Push Side: 1200mm wide by 1500mm deep with 300mm beside latch



Sliding Door – Both Sides: 1200mm wide by 1500mm deep



Pre-wired Power Door Operator – Both Sides: 1000mm wide by 1500mm deep



Lavatory: 800mm wide by 1350mm deep with max 430 beneath lavatory



Shower: 1500mm wide by 900mm deep in front of shower



Toilet: 900mm wide by 1500mm deep adjacent toilet

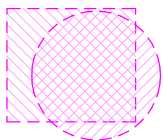

Kitchen and Bedroom: 1700mm diameter OR 1700mm by 1500mm

1.4.1.2. Defined Terms

- 1) The words and terms in italics in this Code shall have the following meanings:

Access or ***Accessible*** means an area and its facilities, or both, as required by this Code, which is easy to approach, enter, exit, operate, participate in, pass to and from, and use safely and independently by *persons with disabilities*.

Adaptable dwelling unit means a *dwelling unit* designed and constructed with some *accessible* features and which accommodates the future modification to provide more *accessible* features.

Persons with disabilities means persons who have a permanent or temporary physical, mental, intellectual or sensory impairment which, in interaction with various barriers, may hinder their full and effective participation in society on an equal basis with others.

Defined Terms

Terms in italics are defined terms in the 2024 BCBC.

Content reproduced from the Notes to Part 3 along with commentary notes in this guide do not include the italicized terms in the Building Code, their content is for information only and not part of the legal language within the 2024 BCBC.

3.8.5.1. Application

1) Applicable Dwelling Unit Types

Ministerial Order
No. BA 2025 01

Except as provided in Sentence (2) and as specified by Sentence (3), this Subsection applies to

- a) one *storey dwelling units* served by an *accessible interior public corridor* and an *accessible common building entrance*, as required to be *accessible* by Articles 3.8.2.2. and 3.8.2.3., and
- b) common spaces and facilities intended for use by the residents of the *dwelling units* described in Clause (a) including common rooftop *occupancies*.

2) Reinforcement for Grab Bars in Future

Buildings described in Clause 3.8.2.1.(1)(a) including *secondary suites* and all other *dwelling units* to which this Section applies shall, as required by Sections 3.7. and 9.31., provide at least one bathroom with walls reinforced in accordance with Clause 3.8.5.7.(1)(e).

3) Application to Dwelling Units

Ministerial Order
No. BA 2025 01

At least one for every five or part thereof of dwelling units described in Clause (1)(a) shall conform to this Subsection (See Note A-3.8.5.1.(3).)

Ministerial Order
No. BA 2025 01

Note A-3.8.5.1.(3)

Application to Dwelling Units. The Building Code requires that for every dwelling unit meeting the criteria described in Clause 3.8.5.1.(1)(a) that one for every five units be designed as an adaptable dwelling unit. To calculate, the designer shall take the number of units that meet the criteria of Clause 3.8.5.1.(1)(a) and then design not less than 20 percent of those units to be adaptable. "Or part thereof" means, for example, that if there are two units that meet the criteria of Clause 3.8.5.1.(1)(a) that one of them must be designed to be adaptable and that if there are six units that meet the criteria of Clause 3.8.5.1.(1)(a) that two of them must be designed to be adaptable.

Application

1 in every 5 or part thereof of all dwelling units, regardless of the number of bedrooms provided within the dwelling unit, are required to conform to the adaptable design requirements in Subsection 3.8.5. Reinforcement for grab bars per Sentence 3.8.5.1.(2) is recommended to be provided in all dwelling units.

(See commentary notes on next page for exceptions)

Example: If you have 22 dwelling units you are required to have a minimum of 5 adaptable dwelling units.

For more information on application of the 2024 BCBC please refer to the Building and Safety Standards Branch [Technical Bulletins](#).

Where Grab Bar Reinforcement is Required but Adaptable Provisions Do Not Apply:

- Detached houses
- Semi-detached houses
- Secondary suites
- Townhouses
- Two storey dwelling units in apartment buildings
- Apartments with their own entry/exit to the exterior and no interior connection to the remainder of the building
- Small apartment buildings (See commentary note below for more details)

Small Apartment Buildings – Accessible Access and Adaptable Application

Where a Part 9 building up to 3 storeys and 600m² or a Part 3 building up to 2 storeys and 600m² is provided, this means:

- The entry storey is required to be accessible
- Upper storey(s) are not required to be accessible unless elevator access and/or an amenity space is provided

Adaptable dwelling units are required only at levels provided with an accessible path of travel.

Where Grab Bar Reinforcement and Adaptable Provisions Do Not Apply

Where sleeping rooms and bed spaces are assigned on a temporary basis then adaptable provisions, including the need for grab bar reinforcements **do not** apply, this includes:

- Boarding houses
- Dormitories
- Hotels
- Lodging houses

3.8.5.2. Construction Requirements

1) Prescribed Adaptable Design

The construction of *adaptable dwelling units* and the *building* in which they are located shall conform to the requirements of this Subsection and, as required by this Subsection, to *access* requirements for *buildings of residential occupancy* elsewhere in this Code.

1) Overlapping of Clear Floor Spaces

Unless otherwise required, clear areas and spaces required in this Subsection are permitted to overlap with other clear area and space requirements.

2) Not Requiring Areas but When Areas are Provided

This Subsection does not require an *adaptable dwelling unit* be provided with a living space, a bedroom, a bathroom or a kitchen, but when provided, those spaces and the paths connecting them shall conform to the applicable requirements of this Subsection.

Adaptable Design Provisions

Some provisions are expected to be provided at initial construction, and others are intended for future adapting, as per the adaptable dwelling unit definition. The table provided on the next page provides an overview.

Furniture in Dwelling Units

Furniture is not regulated by the Building Code and can be shown in clear floor spaces.

Wall Removal in Future

Walls, especially those with services in them, should not need to be removed to adapt a dwelling unit in the future, however, moveable partition walls or small partition walls with no services in them could be shown to be moved or removed as part of a future adaptable dwelling unit design solution.

Adaptable Dwelling Unit Provisions Table

This table provides a brief overview of what provisions are expected to be provided at initial construction and what can be adapted in future. Refer to each section in the guide for additional information and details.

Reference	Provision Summary	Expectation
3.8.5.1.(2)	Grab bar reinforcement	At initial construction for future adapting
3.8.5.4.(1) and (3)	Door clear opening width	At initial construction
3.8.5.4.(2), (4) and (5)	Door clear floor space	At initial construction
3.8.5.4.(5)	Pre-wired power door operator	At initial construction for future adapting
3.8.5.5.(1)	Path of travel clear width	At initial construction
3.8.5.6.(1)(a)	Clear floor space adjacent bed	At initial construction
3.8.5.6.(1)(b)	Clear path through bedroom	At initial construction
3.8.5.6.(1)(c)	Closet opening width and clear floor space at closet	At initial construction
3.8.5.7.(1)(a)	Water Closet transfer space	At initial construction
3.8.5.7.(1)(b)	Water Closet distance to adjacent wall	At initial construction
3.8.5.7.(1)(c)	Lavatory design and clear floor space	Adaptable in future
3.8.5.7.(1)(c)	Lavatory plumbing where it penetrates the wall	At initial construction
3.8.5.7.(1)(d)	Shower / bathtub design and clear floor space	Adaptable in future
3.8.5.7.(1)(d)	Shower / bathtub plumbing location in wall	Adaptable in future
3.8.5.7.(1)(e)	Grab bar reinforcement	At initial construction for future adapting
3.8.5.8.(1)	Kitchen continuous counter	Adaptable in future
3.8.5.8.(2)	Kitchen turning area	At initial construction
3.8.5.8.(3)	Kitchen sink design and clear floor space	Adaptable in future
3.8.5.8.(3)	Kitchen sink plumbing where it penetrates the wall	At initial construction
3.8.5.9.(1)	Control, switches, and outlet installation heights	At initial construction
3.2.4.19.(7)	Special outlet for future strobe	At initial construction for future adapting

3.8.5.3. Building Access Requirements

1) Accessible Access to Common Areas from Unit

Common areas, spaces and facilities and all common exterior and interior paths of travel serving *adaptable dwelling units* shall be *accessible* in accordance with Subsection 3.8.2. with *floor areas* protected in conformance with Article 3.3.1.7.

2) Lighting Along Path to Unit

Common corridors and passageways serving *adaptable dwelling units* shall be equipped to provide illumination, measured at floor or tread level, of not less than 50 lx.

3) Special Outlet for Future Strobe

Each *adaptable dwelling unit* shall be provided with special outlet boxes and cover plates as described in Sentences 3.2.4.19.(7).

4) Accessible Access to Non-Common Areas

Unless otherwise required by this Section, common spaces and paths of travel that are not intended to serve the residents of *adaptable dwelling units* need not be *accessible*.

3.8.5.4. Adaptable Dwelling Unit Doorways

1) Clear Opening Width at the Principal Entrance

The principal entrance door to *adaptable dwelling units* shall have a clear width of not less than 850 mm when the door is in the open position.

2) Clear Floor Space at the Principal Entrance

Except as provided in Sentence (5), there shall be a clear floor space in accordance with Sentences 3.8.3.6.(14) and (15) adjacent to and on both sides of the *adaptable dwelling unit* entrance door described in Sentence (1).

3) Clear Opening Width at Doors Within Unit

Within an *adaptable dwelling unit*, every doorway along a path of travel connecting the entrance door described in Sentence (1) with a living space, adaptable bedroom, adaptable bathroom, and adaptable kitchen shall have a clear width of not less than 850 mm when the door is in the open position.

4) Clear Floor Space at Doors Within Unit

Except as provided in Sentence (5), there shall be a clear floor space in accordance with Sentences 3.8.3.6.(14) and (15) adjacent to and on both sides of the doorways described in Sentence (3)

Door Clear Floor Space Design

The clear floor space on each side of the door is required at initial construction. No fixed elements are permitted to be located within the clear floor space.

3.8.5.4.(2) & (4) Minimum Clear Floor Space Required at Adaptable Dwelling Unit Doors Table

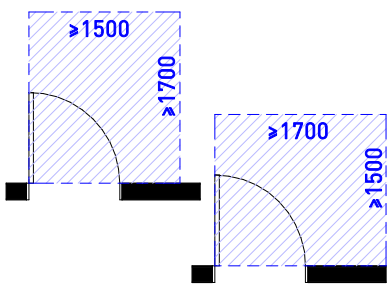
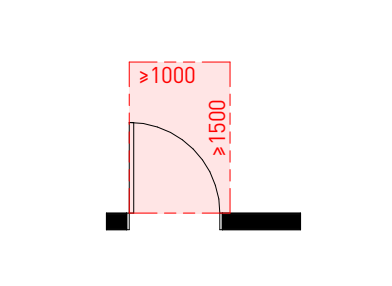
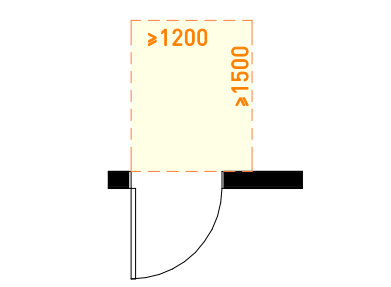
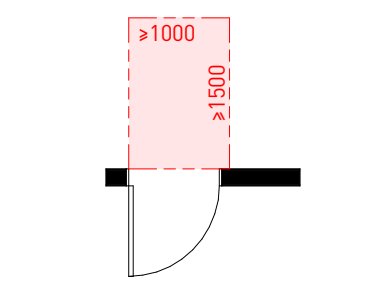
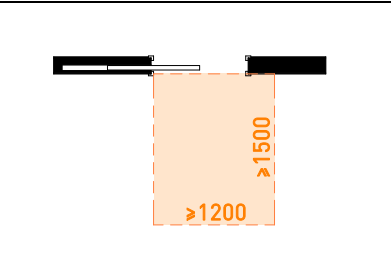
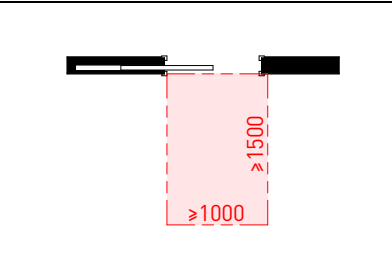
	Manual Door Operation	Door With Pre-Wired Power Door Operator
Pull Side		
Push Side		
Sliding Door		

Door Swing

A door can swing into other required clear floor spaces described in Subsection 3.8.5 (in addition to the clear floor spaces at a door).

Door Clearance Not Required

Clear width and floor space at doors are not required into rooms or spaces, including:

- Laundry
- Storage
- Office
- Balcony
- Additional bed / bath / kitchens that are not adaptable

Door Clear Floor Space Overlap

Clear floor space at doors may extend into:

- A shower (provided it has a low-profile threshold of maximum 13mm and there is no shower partition that could restrict movability at the door).
- A lavatory (on the wall beside the latching side of the door provided clear floor space under lavatory is provided at initial construction).

Door Opening Hardware

Door hardware that would require tight grasping or twisting of the wrist is acceptable, as hardware can be changed in future based on the unique needs of the occupant(s).

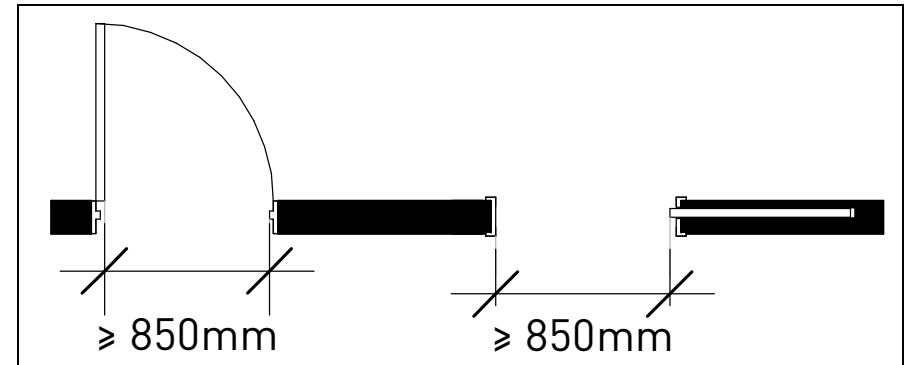

3.8.5.4.(1) & (3) Clear Opening Width

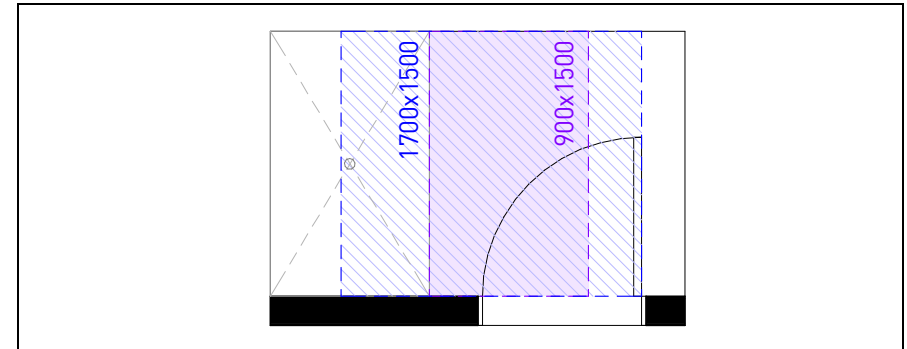

Door Clear Floor Space Overlap into Low Profile Shower

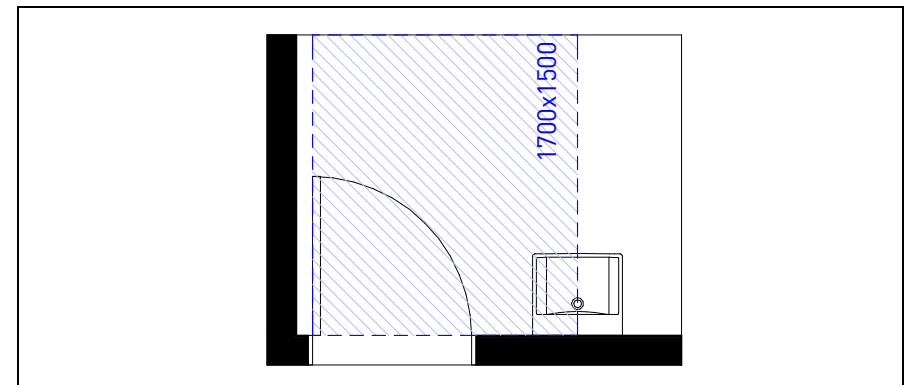

Door Clear Floor Space Overlap with Lavatory

5) Pre-Wired Power Operated Door

Doorways provided with power door operators, or provided with a special outlet box and cover plates that are designed, located and wired specifically to accommodate the future installation of a power door operator, may provide the clear floor space described in Sentence 3.8.3.6.(16).

Pre-Wired Power Door Operator

If a pre-wired power door operator is proposed, it is to consist of an electrical box located above or adjacent the door with pre-wired power and a cover plate.

The pre-wired system does not need to have any additional electrical boxes for operator controls, as the system can be retrofit to fit the unique needs of the occupant(s) (e.g. control buttons or remote activation).

It is not expected that an electric strike be installed or that the pre-wired power to the junction box be on emergency power.

Bathrooms with Multiple Doors

If the adaptable bathroom has a door directly to the adaptable bedroom, while also having a door to the remainder of the unit, the door clear floor space and clear opening width provisions are only to be provided at one door. (See [Article 3.8.5.6](#) commentary regarding path through bedroom to adaptable bathroom)

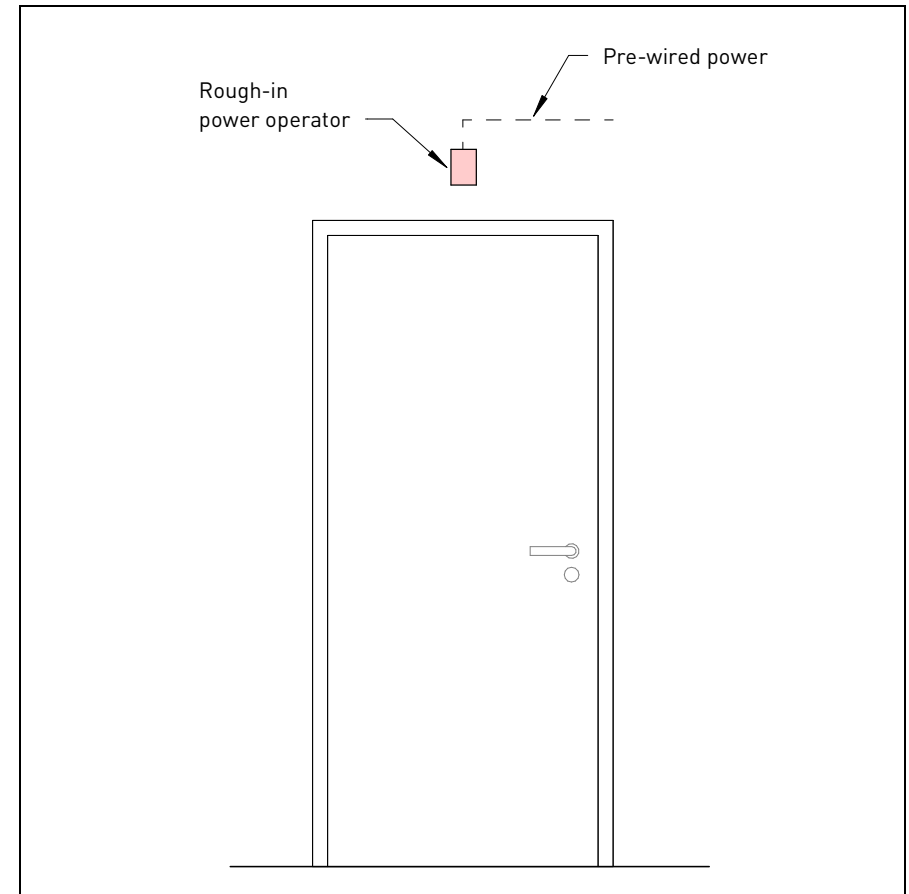

3.8.5.4.(5) Pre-Wired Power Operated Door Installation

3.8.5.5. Adaptable Dwelling Unit Hallways and Corridors

1) Path of Travel Clear Width

Hallways and corridors in *adaptable dwelling units* forming a path of travel connecting the entrance door described in Sentence 3.8.5.4.(1) with a living space, adaptable bedroom, adaptable bathroom and adaptable kitchen shall have a clear width conforming to Sentences 3.8.3.2.(1) and (2).

Sentence 3.8.3.2.(1) and (2)

- 1) Except as required elsewhere in this Part or as permitted by Sentence (2) and Article 3.8.3.6. pertaining to doorways, the clear width of an accessible path of travel shall be not less than 1 000 mm.
- 2) The clear width of an accessible path of travel is permitted to be reduced to not less than 850 mm for a length of not more than 600 mm, provided the clear floor space at either end of the reduced-clear width section is level within a rectangular area
 - a) Whose dimension parallel to each end of the reduced-clear width section is not less than 1 000 mm, and
 - b) Whose dimension perpendicular to each end of the reduced-clear width section is not less than 1 500 mm.

Paths Not Required

Clear path is **not** required to spaces, including:

- Laundry
- Storage
- Office
- Balcony
- Additional bed / bath / kitchens that are not adaptable

Path of Travel Through Unit

Although the code specifically notes hallways and corridors, this provision similarly extends to other areas within a unit between fixed elements.

Path of Travel Through Kitchen

It is expected that a clear width of 1000mm be provided into and throughout a kitchen.

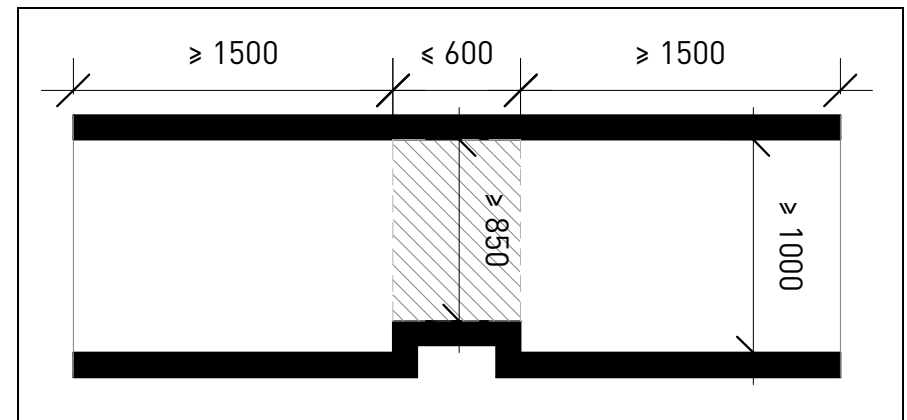

3.8.3.2.(2) Acceptable Clear Width Reduction

3.8.5.5.(1) Path of Travel Clear Width Through Example Units



3.8.5.6. Adaptable Dwelling Unit Bedrooms

1) Bedroom Design Requirements

At least one bedroom or sleeping space in an *adaptable dwelling unit* shall have

- a) a floor area that permits a turning area of not less than 1 700 mm in diameter, or not less than 1 700 mm by 1 500 mm, that could be adjacent a bed,
- b) a pathway clearance of not less than 850 mm wide, that could be unobstructed by a bed, to allow functional use of the bedroom, and
- c) at least one closet that provides
 - i) a clear opening width of not less than 900 mm, and
 - ii) a clear floor space, that need not be separate from the turning areas required in Clause (a), of not less than 1 700 mm in diameter or 1 700 mm by 1 500 mm on at least one side of the closet.
(See Note A-3.8.5.6.(1).)

Note A-3.8.5.6.(1)

Adaptable Dwelling Unit Floor Area. An adaptable dwelling unit bedroom shall be designed so that furniture will not be a barrier to functional use of the space. Occupant load is regulated by this Code though beds and furniture are not. Subsection 3.1.17. establishes an occupant load of two people per sleeping room. As such, it is reasonable to account for a bed that can sleep two people and functional manoeuvring space adjacent the bed and throughout the room or space. Designs should allow for the bed to be located to accommodate transfer from the turning area to either side of the bed.

Bed Size and Location

A bedroom may be designed based on a double or single bed against a wall to show clear floor space is provided.

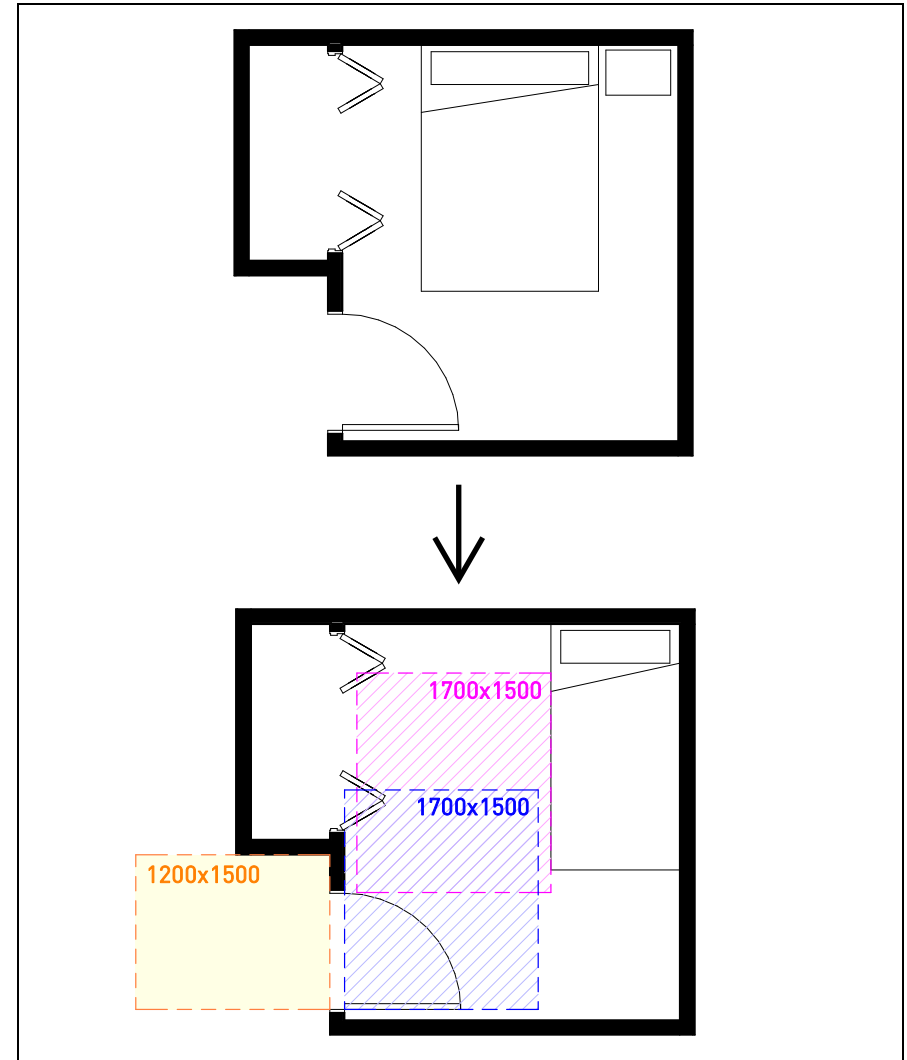

Bed Adjustment to Achieve Clear Floor Space

Pathway in Bedroom

An 850mm path (to allow functional use of a bedroom) is not expected to be provided on both sides of the bed but is to be provided from the bedroom door to:

- Turning area adjacent the bed
- Turning area in front of a closet
- Ensuite (if designed to be adaptable)
- Controls intended to be frequently operated (i.e. light switch and thermostat)

The path through the bedroom can overlap with the clear floor space adjacent the bed and in front of the closet per Sentence 3.8.5.2.(2).

The code does not require a route to an operable window be provided, however it is recommended to design bedrooms so that furniture won't obstruct the use of a window if it is a required egress window per Section 9.9 of the 2024 BCBC.

Walk-in Closets

The clear floor space required in front of a closet can be provided outside a walk-in closet at the entrance, rather than within the closet itself.

Where a person enters into a closet, the closet door can have a clear opening width of 850mm, other closets where content is accessed at the closet door are required to have a clear opening width of 900 mm.

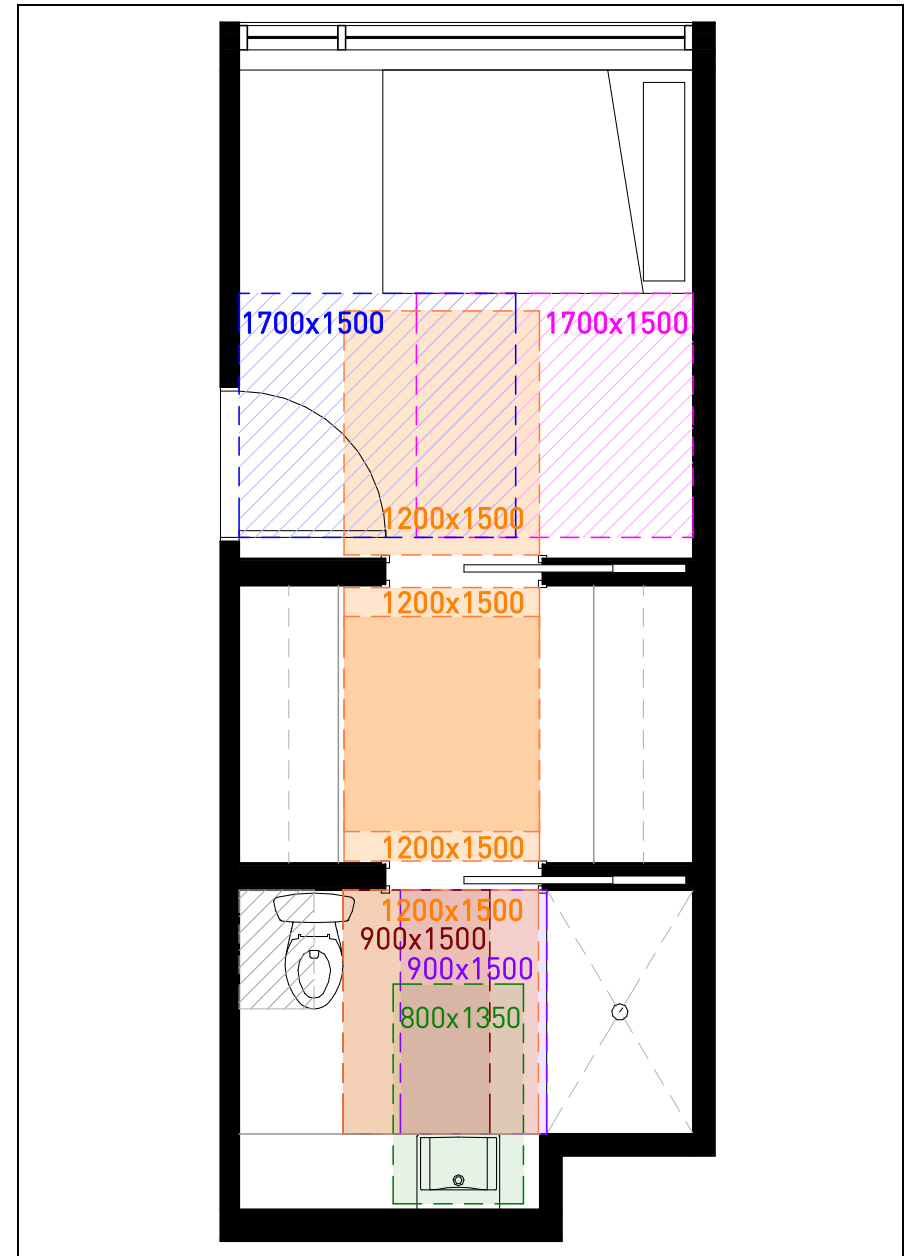

Example Bedroom #1 w/ Ensuite and Walk-in Closet

Bedrooms with Sliding Partitions

A sliding partition that separates a bedroom from the remainder of the unit can be located in the clear transfer space beside the bed provided the partition (when fully open) does not conflict with the clear transfer space.

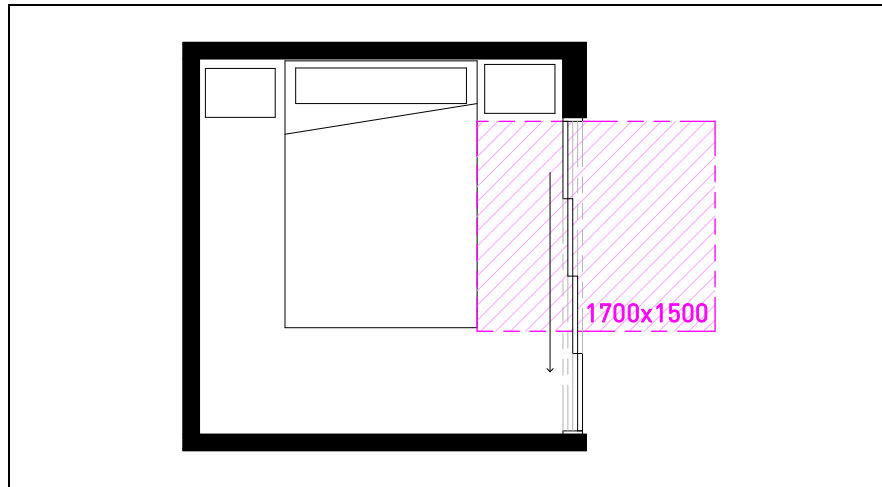

Example Bedroom #2 w/ Sliding Partition

Murphy Bed

Where a murphy bed is provided, clear floor spaces (other than the clear transfer spaces beside the bed) can overlap with the bed, based on the bed being up and out of the way, to allow use of the space for other purposes (e.g. clear space in front of a closet for changing).

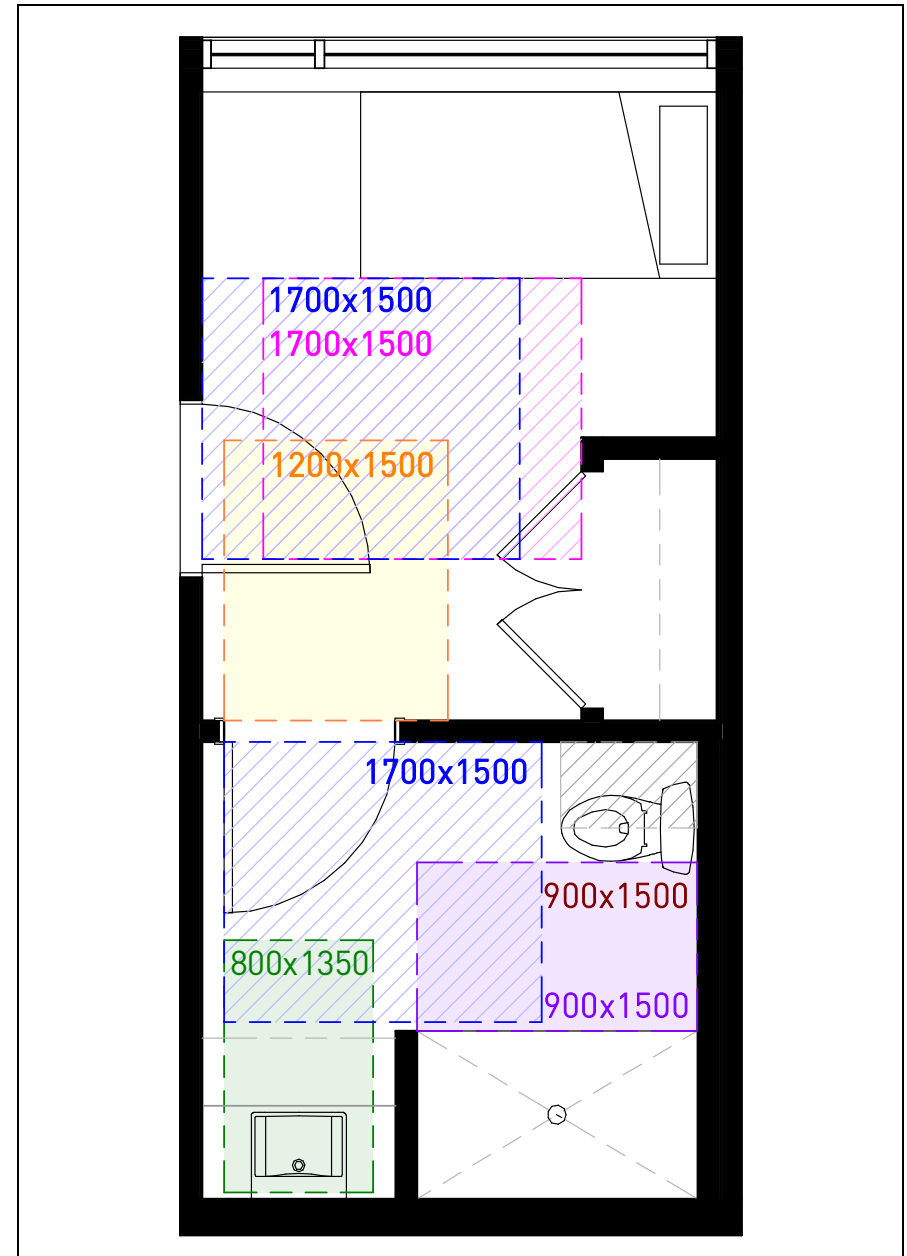

Example Bedroom #3 w/ Ensuite

3.8.5.7. Adaptable Dwelling Unit Bathrooms

1) Bathroom Design Requirements

At least one bathroom in an *adaptable dwelling unit* shall be designed to be adaptable for use by *persons with disabilities* by providing

- a) a clear lateral transfer space adjacent a water closet conforming to Clause 3.8.3.12.(1)(b),
- b) a distance between the centre line of the water closet and the wall on one side of 460 mm to 480 mm,

3.8.3.12.(1)(b) Water Closet Transfer Space

- b) Have a clear lateral transfer space adjacent to the water closet that
 - i) at least 1 500 mm long, measured from the wall behind the water closet, and
 - ii) is at least 900 mm wide, measured from the closest edge of the water closet seat

Water Closet Design

The location of the water closet and the clear transfer space adjacent the water closet is required to be provided at initial construction, with no fixed elements (e.g. counter) within the transfer space.

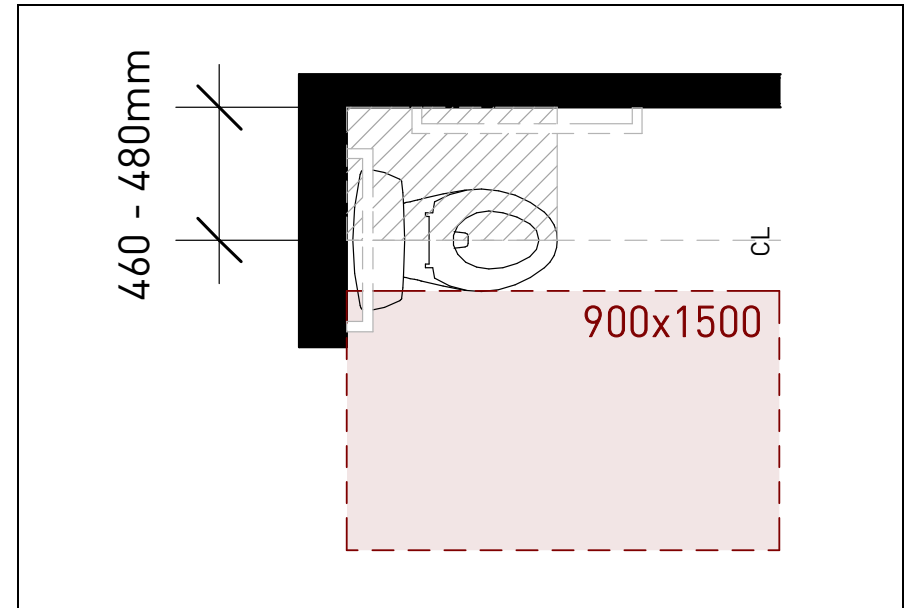

3.8.5.7.(1)(a) & (b) Water Closet Location & Transfer Space

- c) a *plumbing system* that accommodates the future installation of a lavatory with a clear space in accordance with Clauses 3.8.3.16.(1)(a) to (f) that does not impede the space for or use of other fixtures described in this Article (see Note A-3.8.5.7.(1)(c) and (d)),

Note A-3.8.5.7.(1)(c) and (d)

Plumbing Systems. Plumbing systems that accommodate the future installation of fixtures means that the water supply as well as drainage and venting systems are located so that the future installation of an accessible fixture does not require redesign of the system. An example is a sink that can be installed at multiple different heights without requiring a change to where the DWV pipe penetrates the wall.

Lavatory Design

A lavatory **does not** need to be made accessible at initial construction, however, the plumbing system for the lavatory **does need** to be installed to accommodate clear space under the lavatory in future.

The lavatory will need to display that in future it can be made accessible, which includes having a:

- Distance between the centre line of the lavatory and any side wall of minimum 460mm
- Clear floor space of 800mm wide by 1350mm long centred on the lavatory with up to 430mm under the counter, measured from front edge of counter

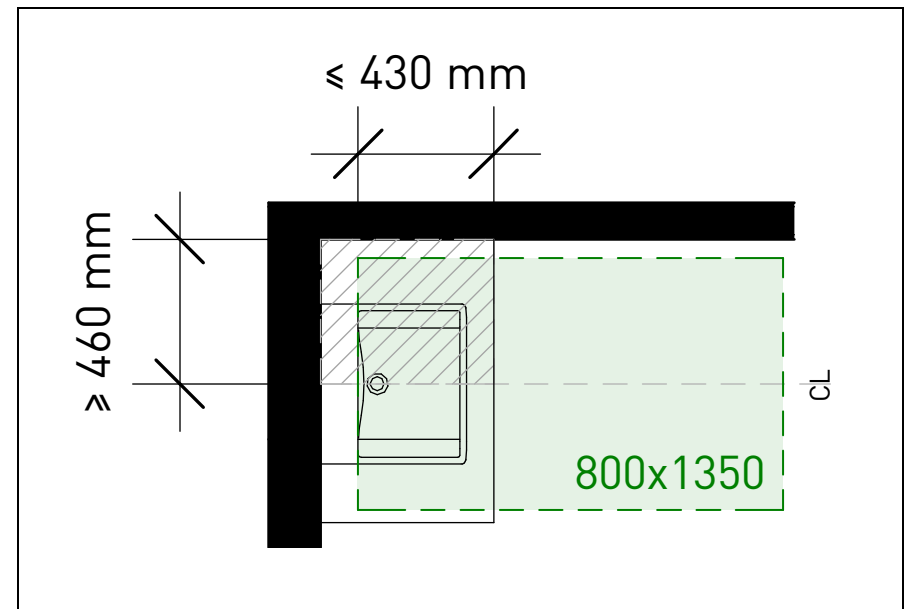

3.8.5.7.(1) Lavatory Location & Clear Floor Space

Lavatory Plumbing System

To accommodate clear space under the lavatory in future, the centreline of drainpipe leading to drain stack is to be minimum 355mm above the finished floor such that the bottom of P-trap achieves a clearance of minimum 230mm from underside of the P-trap to the finished floor.

This is so parts of the lavatory plumbing system do not require moving in future.

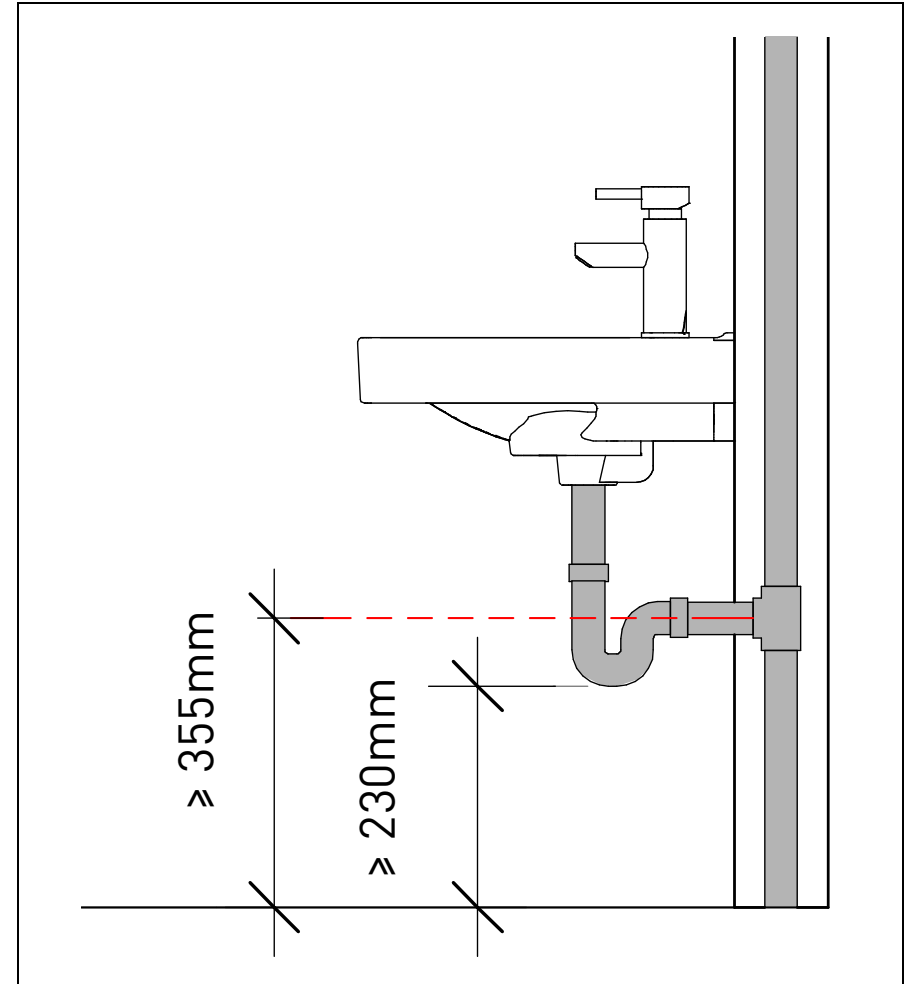

3.8.5.7.(1)(c) Lavatory Plumbing System

Lavatory Location

A lavatory provided with fixed cabinetry or clear space underneath is permitted to encroach into the:

- Clear floor space in front of a bathtub
- Clear turn around space for an accessible bathtub
- Clear floor space in front of a shower (provided it is on the wall opposite to where the vertical grab bar would be located)
- Shower space (provided it is located on the side opposite to where the vertical grab bar would be located and does not impede on the space of other elements (e.g. grab bar))

A lavatory that is wall hung at initial construction with no fixed cabinetry underneath may encroach into the clear transfer space beside a toilet provided the sink is located opposite the toilet.

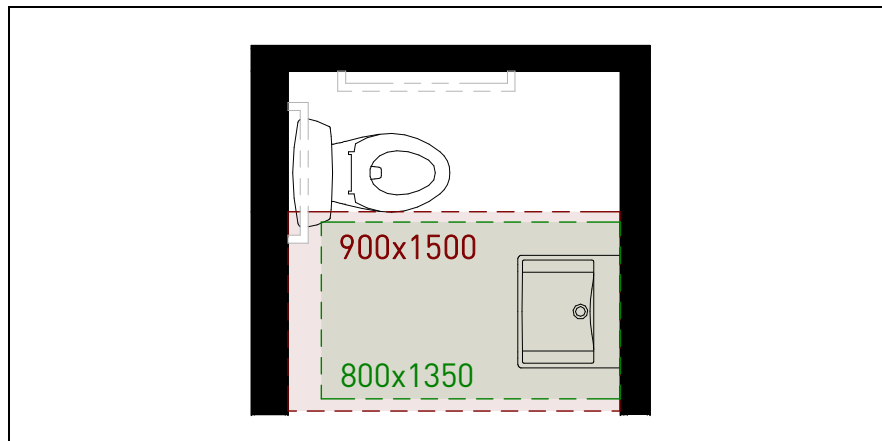

Lavatory in Water Closet Transfer Space

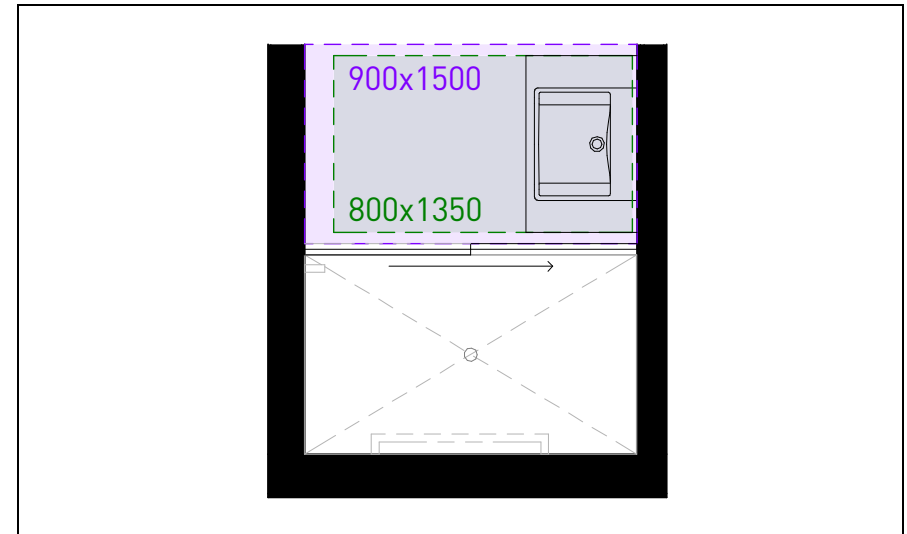

Lavatory in Shower Clear Floor Space

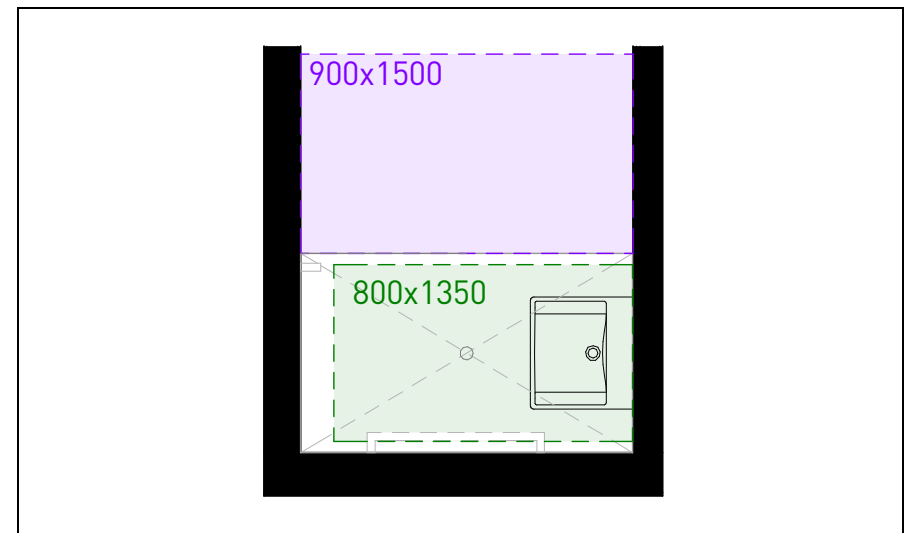

Lavatory in Shower

- d) a *plumbing system* that accommodates the future installation of a
- i) shower described in Sentence 3.8.3.17.(1) that does not impede the space for or use of other fixtures described in this Article, or
 - ii) bathtub described in Sentence 3.8.3.18.(1) that does not impede the space for or use of other fixtures described in this Article (see Note A-3.8.5.7.(1)(c) and (d)), and

Adaptable Shower / Bathtub Design

A shower / bathtub **does not** need to be made accessible at initial construction, however, the plumbing system **does** need to **accommodate** a renovation in future.

The shower / bathtub will need to display that in future an accessible shower / bathtub can be provided, which includes achieving the size and clear floor space requirements.

Smaller sized shower / bathtub may be provided at initial construction provided the space can accommodate an accessible shower / bathtub, and its required clear floor spaces in future.

A bathtub may be converted to an accessible shower in future provided appropriate plumbing infrastructure, grab bar reinforcement, shower size, and clear floor space is provided.

Plumbing System Intent

Adaptable dwelling unit provisions are intended to provide flexibility to accommodate a variety of potential renovations. Plumbing systems, for example, can be problematic to reroute, so having a plumbing system that can accommodate a future renovation to add accessible fixtures helps provide that flexibility.

Shower / Bathtub Plumbing System

The plumbing system for controls and shower head in a shower or bathtub designed to Sentence 3.8.3.17.(1) or Sentence 3.8.3.18.(1) does not need to be provided at initial construction if:

- Rough-in plumbing is located in the wall where the controls / shower head would be required

OR

- Plumbing system can be relocated in future (provided it is possible and practical to reroute plumbing systems in walls that may be loadbearing, fire-rated, exterior)

If it is intended to convert a bathtub to a shower in future the drain location does not have to align between a bathtub and shower basin if a solution can be developed for the drainage system in future (e.g. second drain for shower under bathtub).

- e) walls adjacent the water closet and shower or bathtub location reinforced to accommodate the future installation of grab bars conforming to
 - i) Clauses 3.8.3.12.(1)(f) and (g) for water closets, and
 - ii) Clause 3.8.3.17.(1)(f) for showers or Clauses 3.8.3.18.(1)(f) for bathtubs (see Note A-3.8.5.7.(1)(e)).

Note A-3.8.5.7.(1)(e)

Reinforced Grab Bar Location. This provision is intended to ensure there is adequate backing for the installation of grab bars by the occupant in the future. For example, plywood or solid lumber behind the wall finish and encompassing the location of future grab bars located as described in Clauses 3.8.3.12.(1)(f) and (g) and Clause 3.8.3.17.(1)(f) or 3.8.3.18.(1)(f) would provide suitable backing for grab bar fasteners.

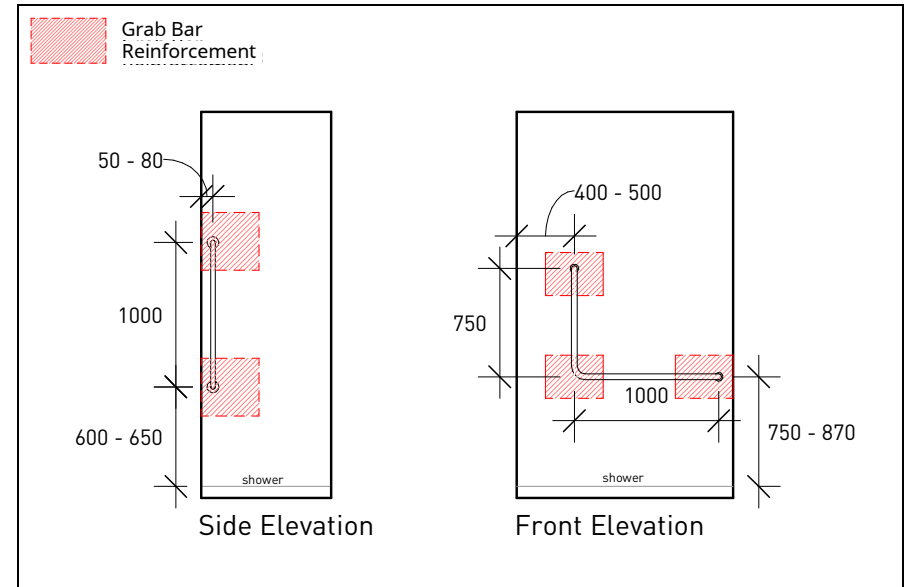

3.8.5.7.(1)(e)(ii) Shower Grab Bar Reinforcement Example

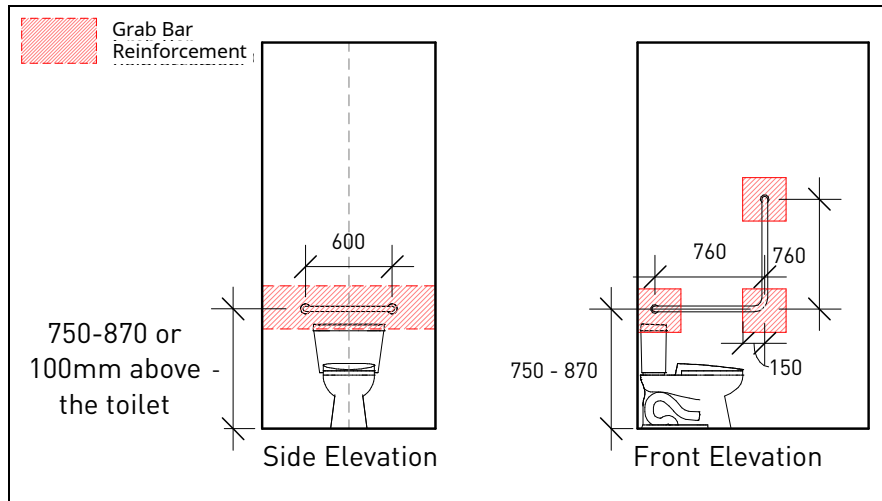

3.8.5.7.(1)(e)(i) Toilet Grab Bar Reinforcement Example

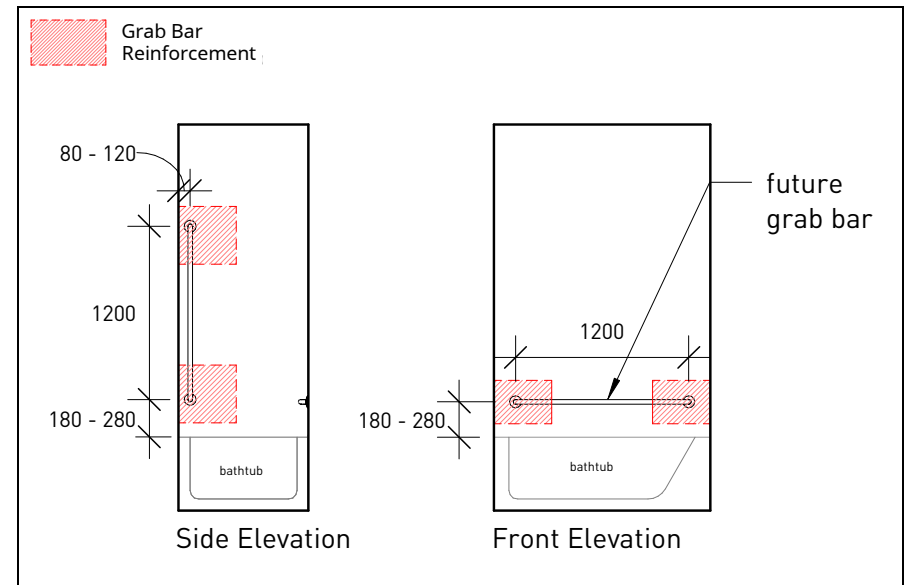

3.8.5.7.(1)(e)(ii) Bathtub Grab Bar Reinforcement Example

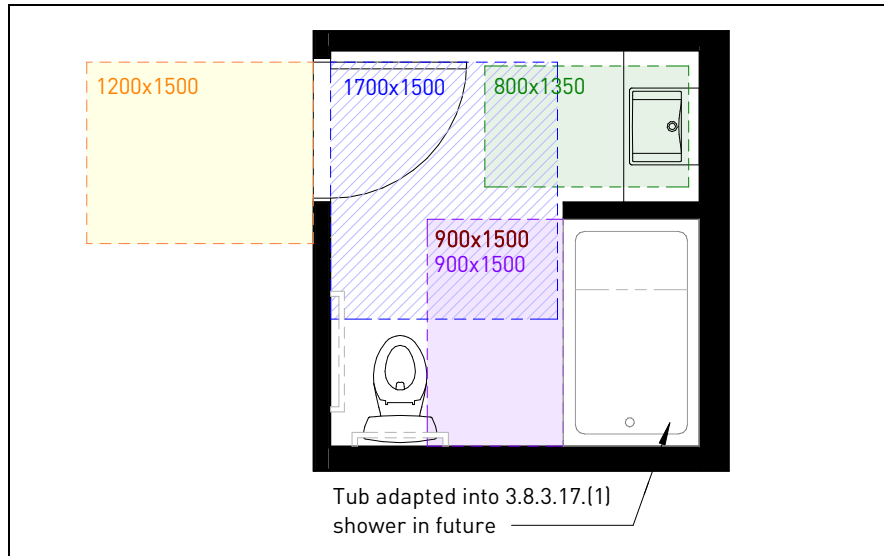

**Example Bathroom Layout #1
w/ Inswing Door**

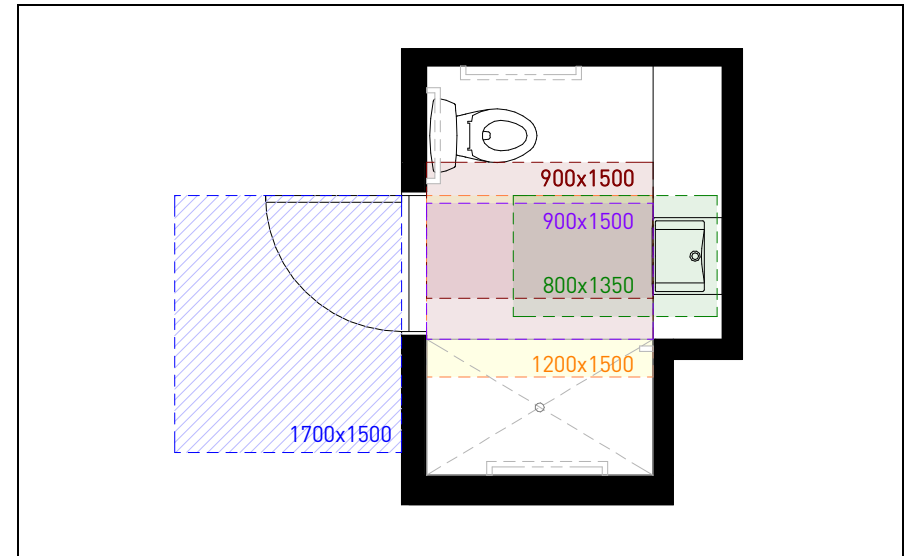

**Example Bathroom Layout #2
w/ Outswing Door**

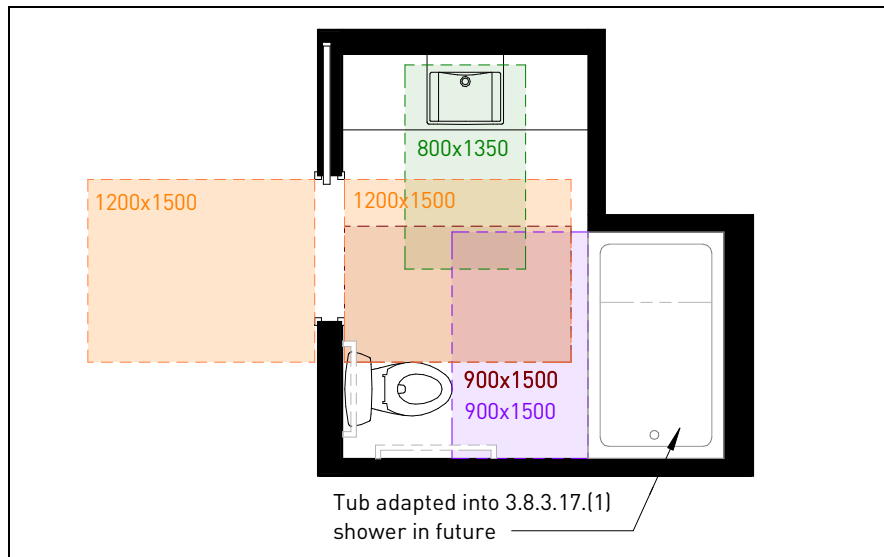

**Example Bathroom Layout #3
w/ Sliding Door**

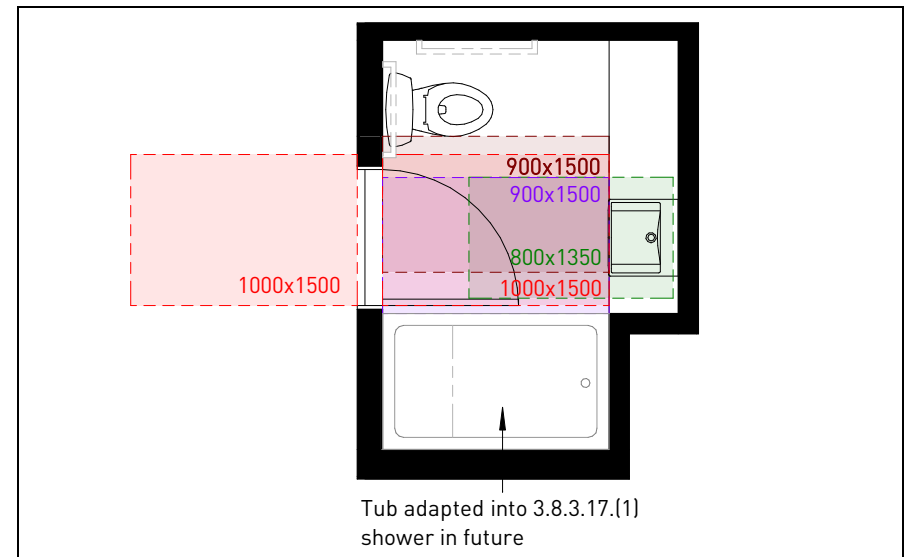

**Example Bathroom Layout #4
w/ Pre-wired Power Door Opener**

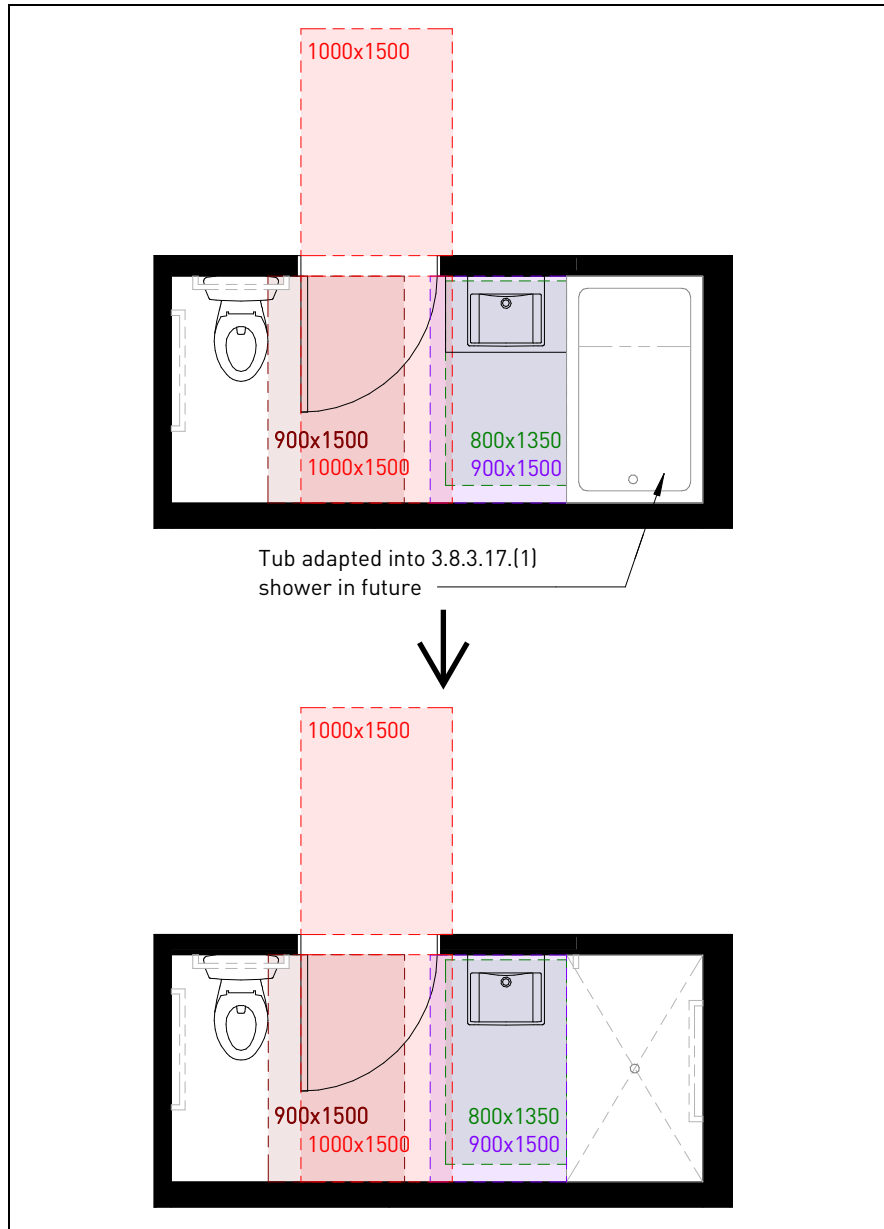

Example Bathroom Layout #5
w/ Pre-wired Power Door Opener & Conversion Design

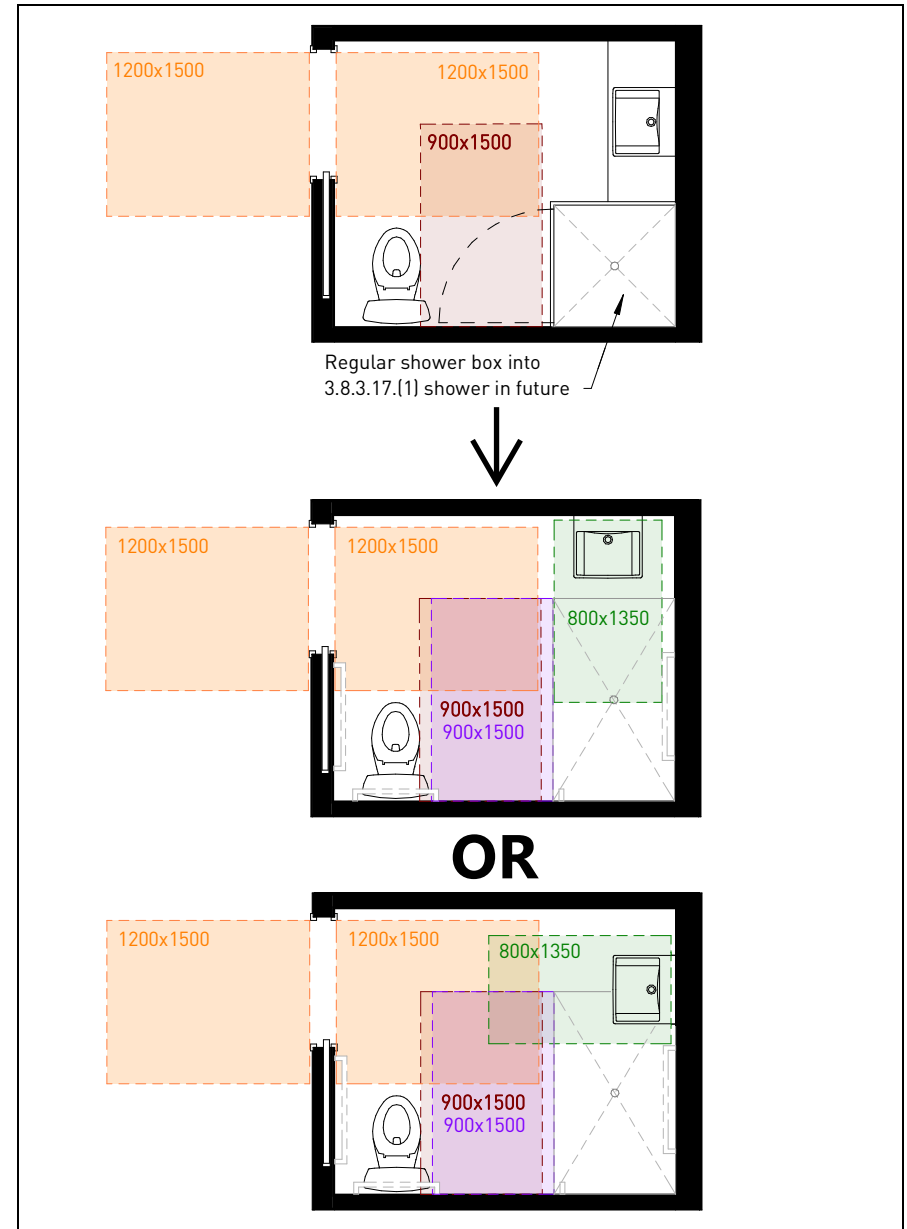

Example Bathroom Layout #6
w/ Wet Bath Conversion Design

3.8.5.8. Adaptable Dwelling Unit Kitchens

1) Continuous Counter Between Sink and Cooktop

The kitchen in an *adaptable dwelling unit* shall be designed so that the *cooktop* and sink are adjacent or can have a continuous counter between them.

2) Turning Area Clear Floor Space

A clear floor space shall be provided in the kitchen area that is not less than 1 700 mm in diameter or 1 700 mm by 1 500 mm.

3) Plumbing for Kitchen Sink

The *plumbing system* serving the kitchen shall accommodate the future installation of a kitchen sink that could be installed in accordance with the requirements for the installation of a lavatory as described in Clauses 3.8.3.16.(1)(b) to (f). (See Note A-3.8.5.7.(1)(c) and (d).)

Turning Area Location

It is expected that the turning space be located within the kitchen, in proximity to appliances. A person should not have to leave the kitchen to turn around.

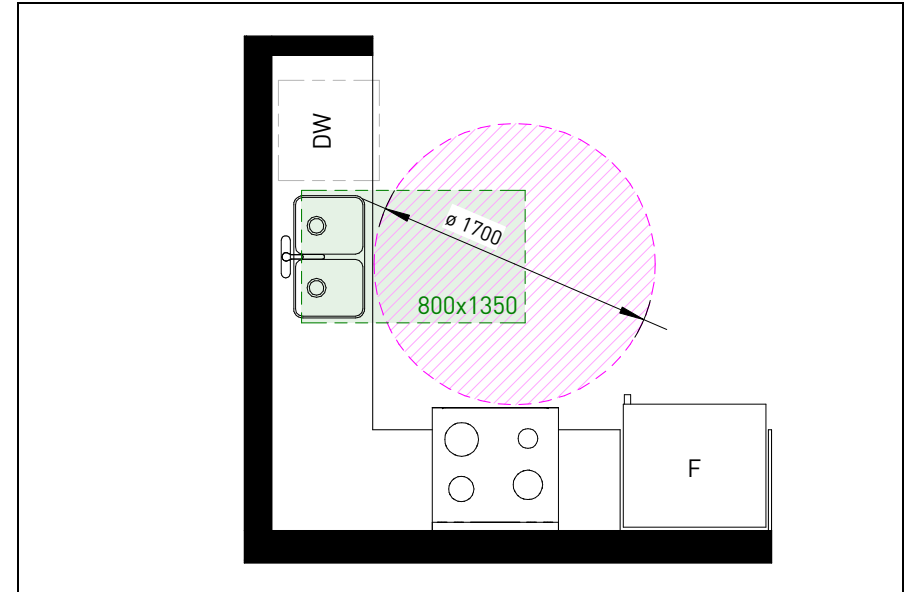

Example Kitchen Layout #1 – L-Shaped Design

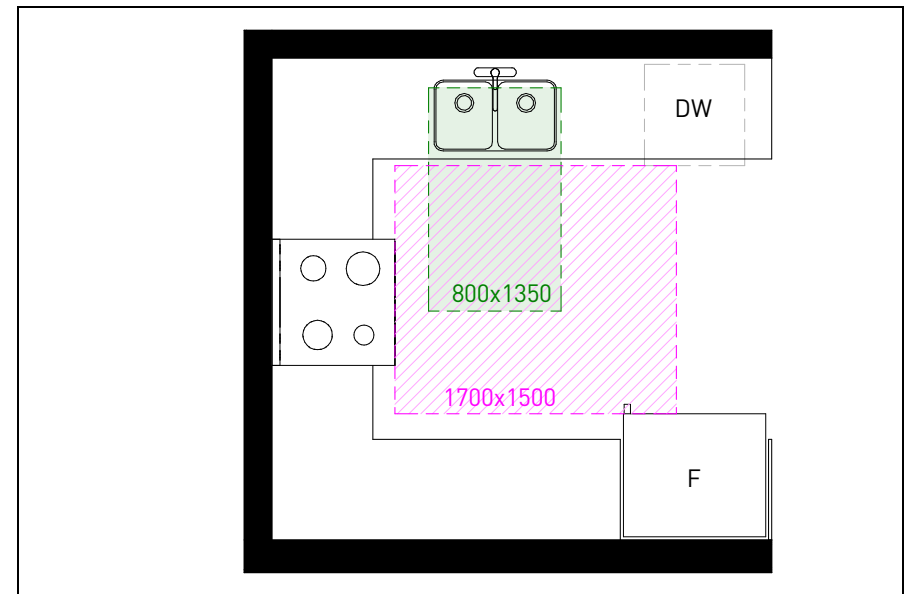

Example Kitchen Layout #2 – U-Shaped Design

Future Continuous Counter

A continuous counter **does not** have to be provided at initial construction if:

- It can be shown that a continuous counter can be provided in future that does not restrict access to the kitchen (It is recommended that the continuous counter addition be minimum 300mm deep).

OR

- A plumbing rough-in and counter space for a second kitchen sink is provided, such that there is a continuous counter between the cooktop and second sink.

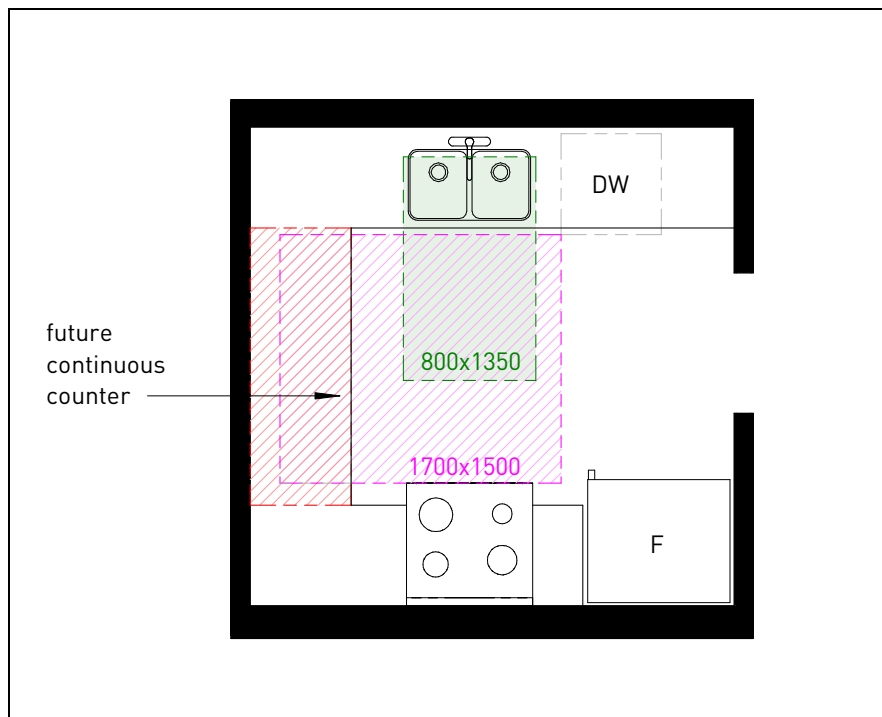

Example Kitchen Layout #3 - w/ Future Continuous Counter

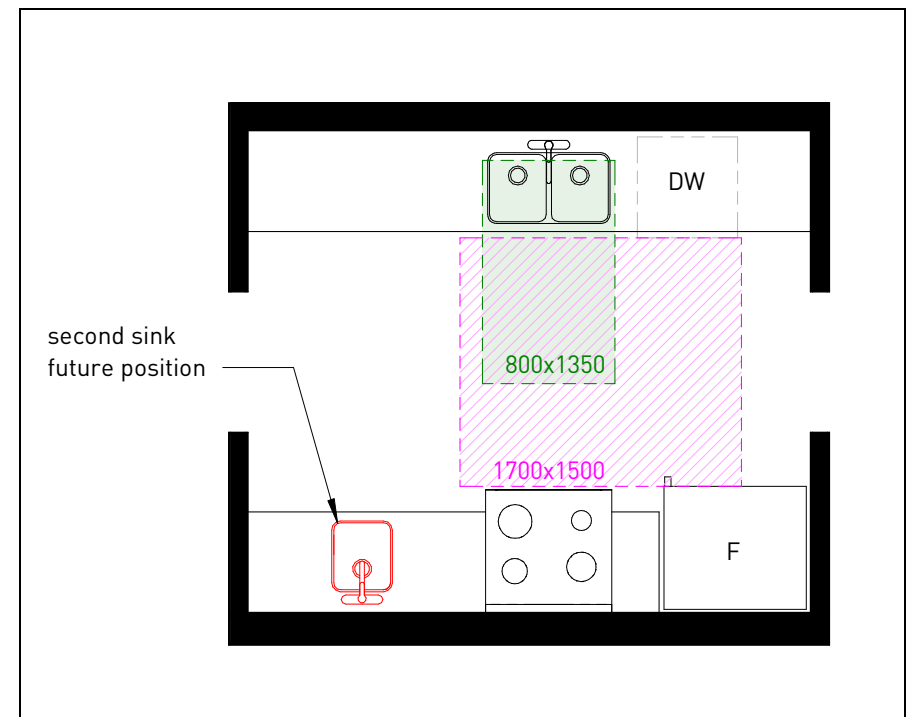

Example Kitchen Layout #4 - w/ Plumbing for Second Sink

Turning Area

Clear turning space is expected to be provided at initial construction with no fixed elements located within the space.

The turning area in the kitchen can extend up to 430mm below a counter provided it has knee clearance at initial construction and is limited to one side of the turning area.

Where a kitchen island or cabinetry below a counter is movable (i.e. non-fixed), the turning area can encroach into these elements at initial construction.

Kitchen counter overhangs, cabinet handles, and other small projections into the turning area do not need to be taken into consideration in determining clear turning space.

Appliances such as a range or refrigerator should be taken into consideration when designing the kitchen so that they do not impact the turning space.

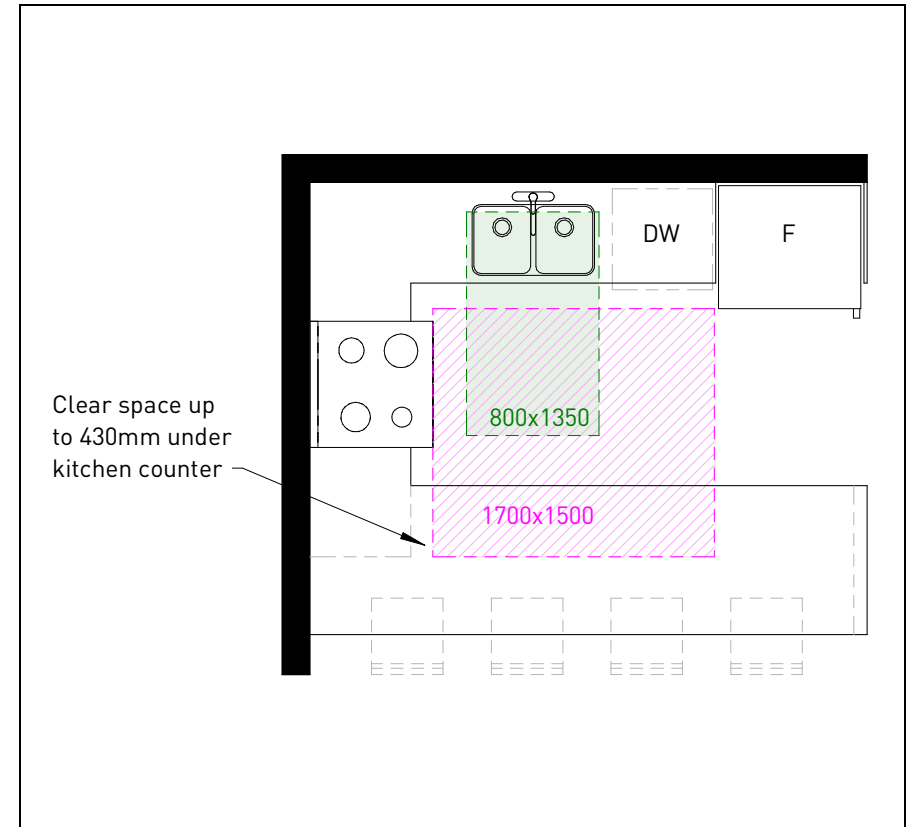

**Example Kitchen Layout #5
w/ Turning Area Overlapping Counter**

3.8.5.9. Controls, Switches and Outlets

1) Installation Requirements

Except as provided in Sentence (2), controls and switches for *building* systems and outlets in *adaptable dwelling units*, that are intended for frequent operation by occupants, shall not require activities for operation below 400 mm from the floor or above 1 200 mm from the floor.

2) Exemptions

Sentence (1) does not apply to controls, switches and dedicated outlets for equipment or appliances.

Exemptions to Controls, Switches and Outlets

Elements that are **not required** to meet the installation height requirements, include:

- Hood fans
- Breaker panels
- Telephone / Television / Data Outlets
- Outlets specific for appliances
- Controls for operable windows
- Controls, switches, outlets provided on decks
- Controls for equipment and appliances (e.g. washer, dryer, stove, microwave)

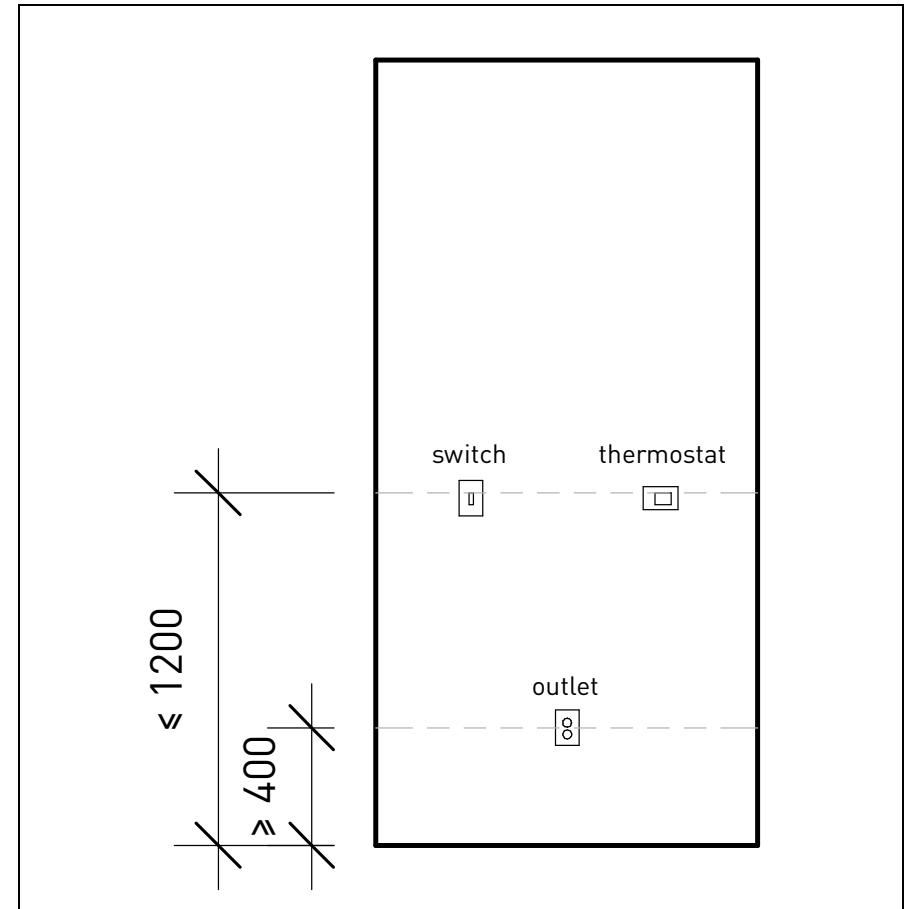

3.8.5.9. Control, Switch and Outlet Height Range

3.2.4.19.(7) Special Outlet for Future Strobe

7) Special Outlet for Strobe Design Requirements

Each adaptable dwelling unit shall be provided with special outlet boxes and cover plates that

- a) are designed, located and wired specifically to allow strobe lights to operate in conformance with
 - i) Sentence (5) where a fire alarm system is provided, or
 - ii) Sentence (6) where a fire alarm system is not provided,
- b) are permanently identified as “FIRE – Strobe Light Connection Only,”
- c) are installed in the locations described in Clause (4)(e), and
- d) for the purposes of providing power to the strobe lights that may be connected to the outlet boxes, are assumed that the total special outlets for at least 20 percent of the adaptable dwelling units in the building are in use.

3.2.4.19.(4)(e) Visible Signal Locations

- 4) Visible signal devices shall be installed in the rooms and spaces required by Article 3.2.4.20. and Section 3.8. and shall
 - e) be installed in each
 - i) sleeping room or bed space
 - ii) room closed off from the living area by a door, including bathrooms, and
 - iii) living area and any hallway serving the living area

Visible Signal Locations

Rooms closed off from the living area by a door, as noted in Clause 3.2.4.19.(4)(e), include:

- Sleeping rooms
- Bathrooms (including ensuite bathrooms)
- Office
- Den / Flex Space

Walk-in closets or small storage closets **do not** require special outlets as they are not intended for prolonged usage.

Combination of Audible Visual Signalling Devices

Special outlet boxes described in Sentence 3.2.4.19.(7) **do not** need to be provided if audible signal devices located in accordance with Clause 3.2.4.19.(4)(e) can accommodate replacement in future to a combination audible visual signal device.

3.2.4.19.(7) Example Unit of Future Strobe Locations

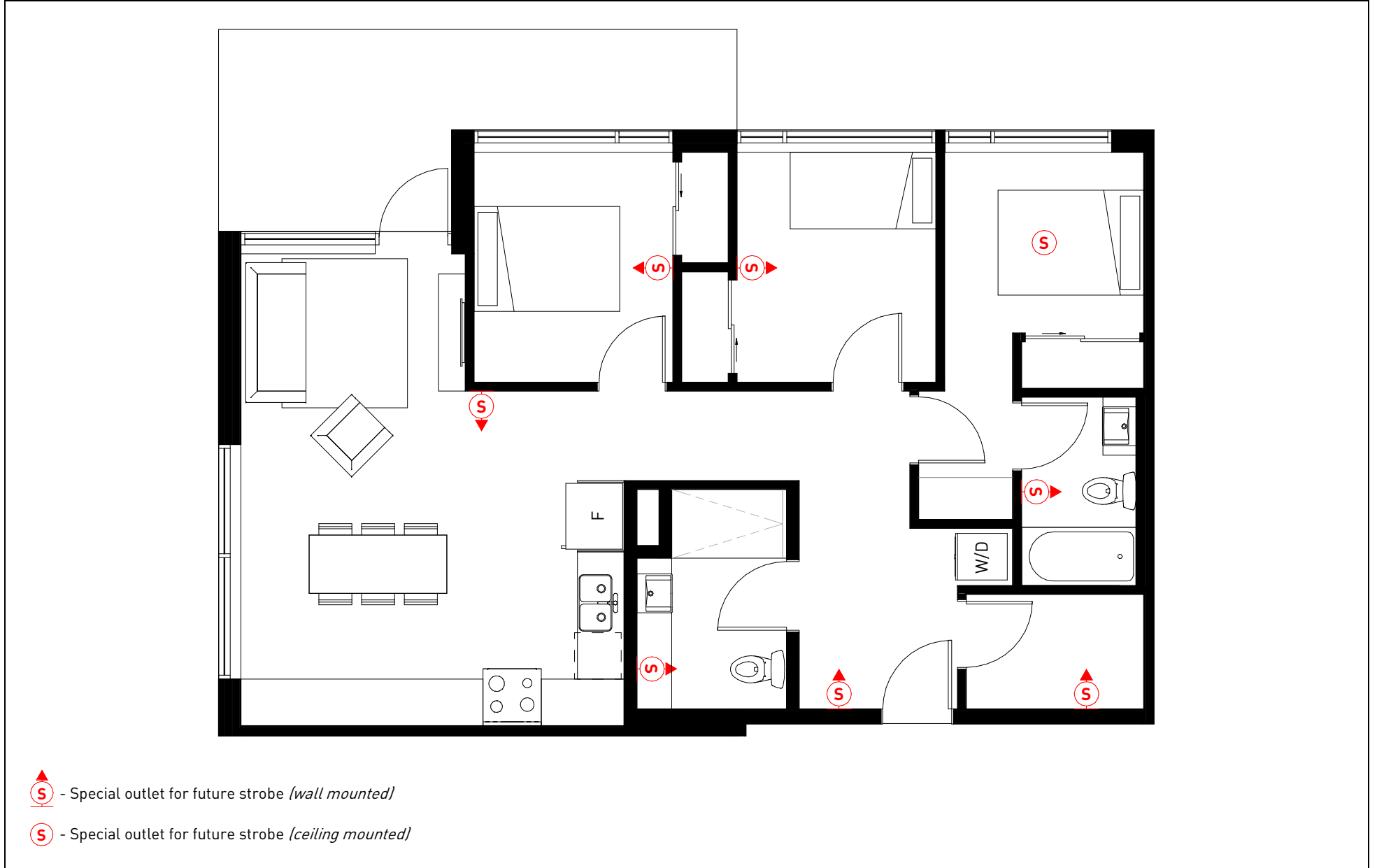

One Bedroom Example Suite (500 sq ft)

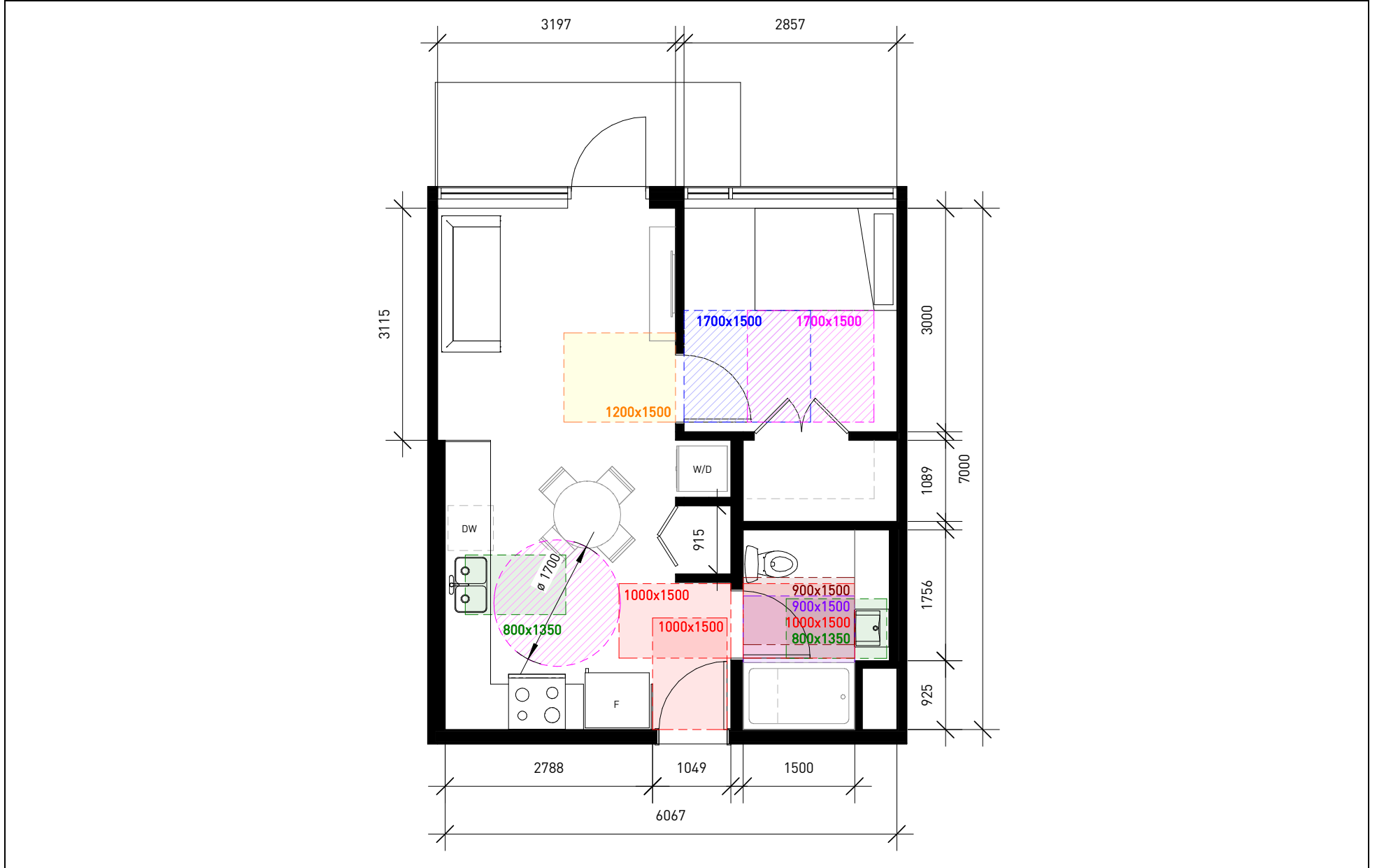

Two Bedroom Example Suite (710 sq ft)

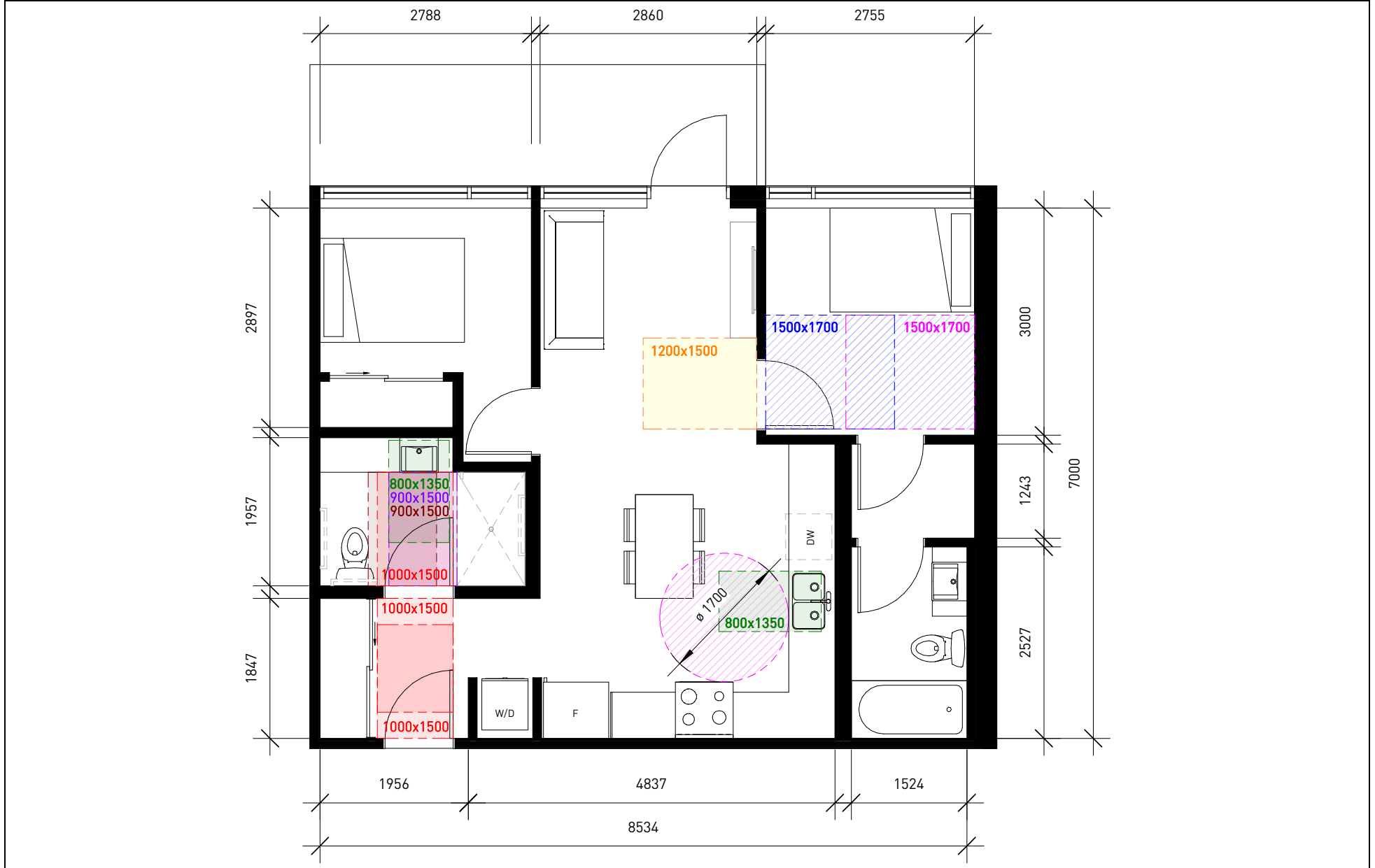

Adaptable Floor Plate Example

Tower Floor Plate with Adaptable Units

