

MoTI Section	1000		TAC Section	Not Applicable
--------------	------	--	-------------	----------------

## 1000 HYDRAULICS CHAPTER

### 1010 General Design Guidelines

1010.01	General.....	1010-1
1010.02	Design Guidelines.....	1010-1
1010.03	Requirements for Drainage Designs .....	1010-4

### 1020 Hydrology

1020.01	Mapping Resources.....	1020-1
1020.02	Watershed Characteristics.....	1020-1
1020.03	Basin and Channel Slope .....	1020-3
1020.04	Time of Concentration .....	1020-3
1020.05	Precipitation.....	1020-5
1020.06	Design Flow Calculation Methods.....	1020-6
1020.07	Hydrology Example .....	1020-7

### 1030 Open Channel Design

1030.01	Design Return Periods.....	1030-1
1030.02	Open Channel Characteristics.....	1030-1
1030.03	Formulae for Open Channels .....	1030-2
1030.04	Channel Lining.....	1030-3
1030.05	Open Channel Structures .....	1030-5

### 1040 Culvert Design

1040.01	Culvert Designation.....	1040-1
1040.02	Culvert Design Considerations .....	1040-1
1040.03	Culvert Hydraulics .....	1040-4
1040.04	Culvert Installation.....	1040-11
1040.05	Culvert Design Example .....	1040-14

### 1050 Pavement Drainage and Storm Sewers

1050.01	Return Period .....	1050-1
1050.02	Pavement Runoff .....	1050-1
1050.03	Pavement Grades.....	1050-1
1050.04	Ponding Widths.....	1050-1
1050.05	Medians and Curbs .....	1050-1
1050.06	Grates/Spillways .....	1050-1
1050.07	Catchbasins .....	1050-10
1050.08	Storm Sewers .....	1050-10
1050.09	Storm Sewer Design Sample .....	1050-17

MoTI Section	1000		TAC Section	Not Applicable
--------------	------	--	-------------	----------------

**1060 Ditch Infilling**

1060.01	General.....	1060-1
1060.02	Sizing .....	1060-1
1060.03	Installation .....	1060-1
1060.04	Cross Culverts.....	1060-2
1060.05	Inlet and Outlet Ditches .....	1060-2
1060.06	Backfilling .....	1060-2
1060.07	Catchbasins .....	1060-2
1060.08	Perimeter and Roof Drains.....	1060-2
1060.09	Planting .....	1060-2
1060.10	Traffic Control .....	1060-2

MoTI Section	1000		TAC Section	Not Applicable
--------------	------	--	-------------	----------------

**1000 HYDRAULICS CHAPTER  
TABLES**

1010.A	Design Return Periods for Hydraulic Structures .....	1010-2
1020.A	Maximum Runoff Coefficient Values for Coastal Type Basins .....	1020-2
1040.A	Manning’s Roughness Coefficient .....	1040-3
1050.A	Grate Catchment Widths .....	1050-1
1050.B	Spillway Catchment Width.....	1050-2
1050.C	Inlet Capacities.....	1050-3
1050.D	Inlet Spacing Tables for Depressed BC Bicycle Safe Grate.....	1050-3
1050.E	Inlet Spacing Tables for Depressed BC Freeway Grate .....	1050-4
1050.F	Inlet Spacing Tables for Undepressed BC Bicycle Safe Grate .....	1050-5
1050.J	Manhole Spacings .....	1050-11
1050.N	Concrete Pipe Trench Installation.....	1050-16

MoTI Section	1000	TAC Section	Not Applicable
--------------	------	-------------	----------------

**1000 HYDRAULICS CHAPTER  
FIGURES**

1010.A Sample Design Criteria Sheet for Climate Change Resilience..... 1010-7

1020.B Time of Concentration ..... 1020-4

1030.A Riprap Design Chart ..... 1030-6

1040.B Hydraulic Design Chart for Circular Steel Pipe..... 1040-6

1040.C Hydraulic Design Chart for Corrugated Steel Pipe-Arch ..... 1040-7

1040.D Hydraulic Sample Chart for Circular Steel Pipe..... 1040-8

1040.E Hydraulic Sample Chart for Corrugated Steel Pipe-Arch ..... 1040-9

1040.F Inlet Control Nomograph..... 1040-10

1040.G Foundation Excavation for Culverts..... 1040-13

1050.G Sample Spreadsheet - Spacing for Depressed/Undepressed  
BC Bicycle Safe Grate ..... 1050-7

1050.H Sample Spreadsheet – Spacing for Depressed/Undepressed  
BC Freeway Grate ..... 1050-8

1050.I Sample Spreadsheet – Inlet Spacing for Spillways..... 1050-9

1050.K Concrete Pipe Storm Sewer Foundation Excavation ..... 1050-13

1050.L Corrugated Steel Pipe Storm Sewer Foundation Excavation..... 1050-14

1050.M Foundation Excavation Volumes per Metre Depth of Manhole..... 1050-15

1060.A Ditch Infilling / Culverting ..... 1060-3



MoTI Section	1010	TAC Section	Not Applicable
--------------	------	-------------	----------------

## 1010 GENERAL DESIGN GUIDELINES

### 1010.01 GENERAL

This chapter has been prepared as a guide to the acceptable procedures and methods used in the development of hydrotechnical design plans for the design, construction and maintenance of British Columbia highways.

It is intended for use by personnel competent to evaluate the significance and limitations of its content and recommendations, and who will accept responsibility for the application of the material it contains. The Ministry of Transportation & Infrastructure disclaims any or all responsibility for the application of the stated guidelines.

This chapter is not intended to be a textbook of hydrotechnical engineering but a reference book of guidelines and instructions. It does not cover all conceivable problems that might arise or address all of the possible methodologies. The scope of the chapter is limited to relatively simple hydrology and hydraulics. Advanced or complicated analyses should be referred first to a hydrotechnical engineer in a MoTI Regional office, then to the Manager, Hydrotechnical Engineering.

The chapter is intended to meet BC conditions and design practices. The chapter is also to be used in conjunction with the following references:

- ◆ *CSPI Handbook of Steel Drainage and Highway Construction Products (2010)*
- ◆ *CSPI Modern Sewer Design (1996)*
- ◆ *Atmospheric Environment Service (AES) Rainfall Frequency Atlas for Canada (1985, Hogg; Carr) \**
- ◆ *Department of Fisheries and Oceans - Land Development Guidelines for the Protection of Aquatic Habitat (1993)* <http://www.dfo-mpo.gc.ca/Library/165353.pdf>
- ◆ *MoTI Standard Specifications for Highway Construction (latest edition)*
- ◆ *RTAC Drainage Manual Volume 1 (1982) and Volume 2 (1987) \**
- ◆ *TAC Guide to Bridge Hydraulics (2001)*

- + *The atlas is available for downloading at [http://climate.weather.gc.ca/prods\\_servs/historical\\_publications\\_e.html](http://climate.weather.gc.ca/prods_servs/historical_publications_e.html)*
- \* *An e-book version (Product Code PTM-DRAIN-EBK) is available for purchase under 'Resource Centre PDFs' in the TAC Bookstore at <http://www.overclick.com/TAC/defaultTAC.aspx>*

Updating this chapter is a continuing process and revisions will be issued as required.

### 1010.02 DESIGN GUIDELINES

#### Bridge and Culvert Hydrotechnical Design

The BC MoTI *Bridge Standards and Procedures Manual* shall be referenced for hydrotechnical design of bridges and culverts  $\geq 3$  m in span.

Hydrotechnical design of bridges and large culverts ( $\geq 3$  m span) requires an understanding of the complex relationship between channel morphology, hydrology, bridge hydraulics, and scour protection and is beyond the scope of this guide. This can also apply to culverts with less than a 3 m span on natural watercourses. The design of all such infrastructure and associated works shall comply with the requirements of the latest editions of the Transportation Association of Canada (TAC) *Guide to Bridge Hydraulics* and the *Canadian Highway Bridge Design Code*.

#### Design Flood Return Periods

The design flood return period criteria indicated in **Table 1010.A** shall be used for the design of highway drainage facilities, culverts and bridges.

The selection of the return period for storm sewers from the range specified in the table shall be determined by a professional engineer using risk assessment, general practice and professional judgment.

In some instances, there will be situations when the degree of risk is high enough to justify design return

MoTI Section	1010	TAC Section	Not Applicable
--------------	------	-------------	----------------

periods greater than those shown in the table for gutters, storm water inlets, storm sewers and highway ditches. Similarly, there will be situations when the degree of risk is low enough to justify smaller return periods.

The selection of return periods shall consider basin land-use (past and future potential) and climate change that may result in changes to watershed hydrological and geomorphologic regimes.

When using design return periods other than those given in **Table 1010.A**, a documented risk assessment must be completed by a professional engineer and approval for the design return period must be obtained from the Chief Engineer.

It may also be necessary to design drainage facilities to conform to the requirements of local authorities.

Drainage design shall consider potential channel geomorphologic responses and avoid impacts to existing properties and structures in the adjacent channel reach.

When the upstream flood levels are critical, it may be necessary to design the hydraulic structure so as not to increase the upstream water levels. In some instances, it is important to recognize that the BC

Ministry of Environment (MoE) uses the 1 in 200 year return period for maximum daily discharge rate as a provincial standard to define the floodplain area and to control development near watercourses.

Where fish and fish habitat are involved, it may be necessary to design the hydraulic structure to meet the regulatory agencies approval. The designer will find that Fisheries and Oceans Canada (DFO) and the BC Ministry of Forests, Lands, Natural Resource Operations & Rural Development (FLNRO) are generally the regulatory agencies. Environment Canada (for species at risk) and the BC Ministry of Environment (for contaminated sites around aquatic environments) may also have jurisdiction.

The Water Sustainability Act Regulations also apply to all works in and about streams.

When more than one design return period is required from various jurisdictions, the flow return period(s) that could create the most vulnerable scenarios which the highway infrastructure may experience shall be used.

**Table 1010.A - Design Return Periods for Hydraulic Structures (years, maximum instantaneous discharge)**

Hydraulic Structures	Road Classification				
	Low Volume	Local	Collector	Arterial	Freeway
Gutters	-	5	5	5	5
Storm Water Inlets	-	5	5	5	5
Storm Sewers	-	10 to 25	10 to 25	10 to 25	10 to 25
Highway Ditches	25	25	25	25	25
Culverts < 3 m Span for ditch drainage network	50 to 100	100	100	100	100
Culverts < 3 m Span on a natural watercourse	100	100 to 200	100 to 200	100 to 200	100 to 200
Buried Structures & Culverts ≥ 3 m Span <sup>1</sup>	100	200	200	200	200
Bridges <sup>1</sup>	100	200	200	200	200
River Training and Channel Control Works	100	200	200	200	200

<sup>1</sup> Design shall be in accordance with BC MoTI *Bridge Standards and Procedures Manual*

MoTI Section	1010	TAC Section	Not Applicable
--------------	------	-------------	----------------

## Climate Change Adaptation

*Refer to Technical Circular T-04/19*

Given the potential for climate change to impact transportation infrastructure in BC, it is prudent to develop directives and guidance for incorporating climate adaptation into engineering designs provided to the BC Ministry of Transportation and Infrastructure.

The Ministry requires engineering design work to evaluate risk and include adaptation measures to the impacts of future climate change, weather extremes and climate-related events, as well as changes in average climate conditions. This applies to all new projects, as well as rehabilitation and maintenance projects.

Supporting resources, such as practice guidance, adaptation project examples and risk assessment methods, can be obtained from sources such as professional associations. Climate information can be obtained from climate resource providers.

Climate change impacts are being felt in communities across the province with more frequent and intense weather extremes and climate-related events causing damage to infrastructure, property, and ecosystems. Therefore, climate change adds additional challenges to environmental risks of flood, wildfire, landslide, geologic subsidence, rock falls, avalanche, snow, ice, temperature extremes and variability, extreme precipitation, and storms of various intensities.

The design life of transportation infrastructure is inherently long, thus service requirements for roads, bridges, tunnels, railways, ports and runways may be required for decades, while rights-of-way and specific facilities may continue to be used for transportation purposes for much longer. Thus, climate change presents added risks to the long-term reliability of interconnected systems that are already exposed to a range of stressors such as aging and deteriorating infrastructure, environmental risks, land-use changes, and population growth.

Consequently, infrastructure designers and operators must consider the magnitude of potential stress that any project will be expected to withstand over its design life. While transportation infrastructure is currently designed to handle a broad range of impacts based on historic climate, preparing for future climate change and weather extremes and other climate related events as well as changes in average climate conditions is also to be considered.

Thus, preparing for implications regarding the design, construction, operation, and maintenance of transportation systems to future conditions is critical to protecting its integrity and current and future investment of taxpayer dollars and will result in wise use of resources.

The *Design Criteria Sheet for Climate Change Resilience* summarizes the impacts of future climate change and weather extremes and the implications to engineering project infrastructure components. This sheet will include a list of infrastructure components at risk of being impacted by future climate change events and detail adaptation measures and costs included in the infrastructure design. Please list the climate risks encountered for project components. Adaptation costs are the estimated costs of climate adaptation for the components of the project (such as increasing the size of culvert pipes, etc.). One criteria sheet is required per discipline involved in design work. See **Figure 1010.A** at the end of section 1010 for a sample sheet. All Design Criteria Sheets are to be submitted to the Chief Engineer's Office at: [BCMOTI-ChiefEngineersOffice@gov.bc.ca](mailto:BCMOTI-ChiefEngineersOffice@gov.bc.ca).

Designers involved in new design and rehabilitation projects will integrate consideration of the impacts of future climate change and weather extremes into design parameters and adaptation responses by:

1. Reasonable consideration of the impacts of future climate change and weather extremes appropriate to the scale of the project (including new, rehabilitation and maintenance projects).
2. Using risk assessment methods and climate information for design work from sources

MoTI Section	1010	TAC Section	Not Applicable
--------------	------	-------------	----------------

such as those listed at the end of this section (and on the BC MoTI Climate Change and Adaptation website: <http://www2.gov.bc.ca/gov/content/transp/ortation/transportation-environment/climate-action/adaptation>).

3. At the concept stages, the designer will identify design components at risk from the impacts of future climate change and weather extremes over the expected project design life.
4. At the concept stages, the project designer will summarize changes in temperature, precipitation and other climatic variables over the expected project design life
5. The project designer will identify the risks to project design components from these projected climate changes and summarize the risks in the *BC MoTI Design Criteria Sheet for Climate Change Resilience*.
6. The project designer will develop adaptation design strategies to address climate change risks for the project.
7. Based on evaluation of future climate change effects and impacts, the project designer will develop a project-appropriate set of design criteria for event preparedness and resiliency.
8. Engineering design parameter evaluation and modification for adaptation to climate change will be summarized and listed on the *BC MoTI Design Criteria Sheet for Climate Change Resilience*.
9. The design team will implement the developed design criteria into the project.

Climate Adaptation and Vulnerability Analysis Sources:

- ◆ [BC MoTI Climate Adaptation site](#)
- ◆ [Engineers & Geoscientists BC - Climate Change Practice Guidelines](#)
- ◆ [Pacific Climate Impacts Consortium](#)

- [Analysis Tools - Plan2Adapt, etc.](#)
- ◆ [Pacific Institute for Climate Solutions](#)
  - [Climate Insights 101](#)
- ◆ [Public Infrastructure Engineering Vulnerability Committee](#)
- ◆ [IDF CC Tool \(Western University Ontario\)](#)
- ◆ [Ouranos \(Quebec\)](#)
- ◆ [Intergovernmental Panel on Climate Change \(IPCC\)](#)
- ◆ [Federal Highway Administration – Climate Adaptation \(USA\)](#)
- ◆ [AASHTO – Transportation and Climate Change Resource Center \(USA\)](#)

### 1010.03 REQUIREMENTS FOR DRAINAGE DESIGNS

#### Land Development Drainage Design

##### **Dual Drainage Concept**

All drainage works shall be designed utilizing the dual drainage or minor/major system concept.

The minor or piped system consists primarily of the storm sewer system comprised of inlets, conduits, manholes and other appurtenances designed to collect and discharge into a major system for frequently occurring storms (e.g. less than 5 to 10 year return period).

The major or overland system will come into operation once the minor system's capacity is exceeded. Thus, in developments where the major system has been planned, the streets and ditches may act as open channels directing the excess storm water to nearby watercourses without endangering the public, damaging property or causing excessive erosion. The major system shall be designed to convey a 100 year return period peak discharge.

For information on the dual drainage system, refer to:

- ◆ *CSPI Modern Sewer Design (1996), p. 139.*

MoTI Section	1010	TAC Section	Not Applicable
--------------	------	-------------	----------------

### Discharge Rates for Land Development

All drainage systems must include run-off controls to limit post-development peak discharge rates to the pre-development rates for 5 year return period storms.

In line with *Stormwater Planning, A Guidebook for British Columbia*, developers should also turn their mind to source controls to manage minor event run-off on site. For instance, aiming to infiltrate half of the mean annual rain event (MAR) on site is an objective in line with modern stormwater practice. Site suitability to infiltration should be assessed.

An additional Ministry requirement is an assessment of the receiving ditch or watercourse for peak flows greater than a 5 year return period up to a 100 year return period. The assessment must document the net change in water velocity in the ditch or receiving water, identify any potential impacts from increased peak flows, and make recommendations for mitigation. In other words, flows must be managed to ensure that no increase in flooding and stream erosion occur as a result of development storm drainage.

For information on Storm Drainage Design refer to:

- ◆ *Master Municipal Construction Document (MMCD) Design Guideline Manual (2005)*
- ◆ *Stormwater Planning, A Guidebook for British Columbia*
- ◆ *Water Balance Model for British Columbia*

### Water Quality

Run-off quality treatment for highway or land development drainage is good practice, and is often mandated by Federal, Provincial or Regional guidelines or permits. Design considerations include: using catch basins to direct pavement run-off overland instead of direct discharge to streams, topsoil and sod lined ditches, filtration ditch blocks, and/or water quality ponds at ditch outlets to streams. A Registered Professional Biologist shall be involved with these designs.

### Reports for Land Development Drainage

The Ministry recommends all Subdivision Development Drainage Reports contain the following information prior to submission:

- existing and proposed site description.
- site hydrology and hydraulic calculations including:
  - pre and post-development flows, return periods and contributing drainage areas;
  - design storm details or continuous simulation details;
  - a table showing the run-off and ditch capacity calculations;
  - detention/retention and other flow control requirements.
- plans/drawings including:
  - site plan with contours and scale noted;
  - existing plan with contours and the layout and identification of the existing system including roads, watercourses, major flow paths, storm sewers, catchbasins, culverts, ditches, etc.;
  - developed site plan with the layout and identification of the proposed drainage system including proposed land uses, lot grading, roads, storm sewers, catchbasins, culverts, ditches, etc.
- if necessary, a discussion of need for and design of features such as detention, erosion and sediment control, water quality improvement ponds, lined channels, inlet/outlet structures, groundwater control, etc.
- listing of problem areas and/or unresolved issues with recommended course of action.

### Detention Storage and Run-off Controls

Proposed works for a development should be designed using the following criteria:

- an increase in downstream flooding or stream erosion will not be allowed. Designs will achieve this requirement unless it can be

MoTI Section	1010	TAC Section	Not Applicable
--------------	------	-------------	----------------

demonstrated that these changes do not adversely impact property or the environment;

- a hydrograph method shall be used to calculate design run-off volumes;
- storage requirements must be checked for a number of storm durations to confirm the maximum storage requirements. (Storm durations that generate the critical peak flow may be different from the duration that generates the critical storage volume);
- 24 hour duration rainfall shall be checked;
- alternatively, continuous simulations may be used in place of design storms for sizing storage volumes and assessing stream impacts;
- the detention ponds should be designed to reduce all post-development discharge rates up to the 5-year return period to the corresponding pre-development rates;
- un-attenuated flood waters in excess of the 5 year discharge that by-pass the detention facility must not adversely affect the receiving ditch or channel. Documentation of this assessment is required for all projects.
- an unconfined emergency spillway capable of passing a 100 year peak discharge should be provided to direct overflow safely into the downstream watercourse.

In areas where a Master Drainage Plan has been developed, all subsequent drainage designs should conform to the plan.

The Subdivision Development Drainage Report must provide sufficient information to allow the reviewer to understand the developer's objectives and to thoroughly assess the hydraulic impacts of the development.

For information on Storm Drainage Design refer to:

- ◆ *Master Municipal Construction Document (MMCD) Design Guideline Manual*
- ◆ *Stormwater Planning, A Guidebook for British Columbia*
- ◆ *Water Balance Model for British Columbia*

## **Highway Drainage Design**

### **Channel and Culvert Profiles**

Channel profiles are required to determine the design hydraulic gradient and critical hydraulic controls and it is good practice to prepare culvert profiles in the drainage details of the design drawing set. These profiles will help to develop ditch, channel and culvert design features such as: adequate depth of coverage for structural pipe design; clearances to utilities or walls; the excavation depth; the rock horizon for culvert trenching; traffic management around proposed excavations; culvert end-treatments and extension components; roadside safety end treatments; fish passage; upstream trash racks and debris flow protection; scour and erosion protection; and energy dissipation provided where needed.

The length of the profile survey upstream and downstream of a structure should be typically 10 to 20 bankfull channel widths or 150 m, whichever is greater. The Ministry representative may require survey profile length extension to capture features that could influence the channel hydraulic characteristics. The profile survey shall record the channel thalweg and all hydraulic grade controls.

### **Reports for Highway Drainage**

Highway drainage design reports are required for small culverts (< 3 m diameter), pavement drainage and storm sewer design, and ditch in-filling. The report should include most information as noted above in "Reports for Land Development Drainage" and also:

- photos of existing culverts;
- a topographic map showing the run-off catchment areas with numbered culverts or drainage outlets/crossings;
- an inventory of culverts and water channels off the highway alignment and shown on the drawings, along with their interconnection to the proposed highway culvert system;
- the maintenance and future renewal and/or replacement requirements for the proposed drainage infrastructure.



MoTI Section	1010	TAC Section	Not Applicable
--------------	------	-------------	----------------

Figure 1010.A Sample Design Criteria Sheet for Climate Change Resilience

<p><b>Design Criteria Sheet for Climate Change Resilience</b></p> <p><b>Highway Infrastructure Engineering Design and Climate Change Adaptation</b></p> <p><b>BC Ministry of Transportation and Infrastructure</b></p> <p><b>(Separate Criteria Sheet per Discipline)</b></p> <p><b>(Submit all sheets to the Chief Engineers Office at:</b>  <b>BCMoTI-ChiefEngineersOffice@gov.bc.ca)</b></p>
---

Project:	<i>(i.e. Project Name and Number)</i>
Type of work:	<i>(i.e. Capital/Rehab/Reconstruction, Bridge Structures, Culverts, Interchange/Intersection/Access Improvement, Corridor Improvement, etc.)</i>
Location:	<i>(i.e. Road Names (Major/Minor), Closest City, Municipality, Cardinal Directions, Electoral District, GPS, LKI Segment and km reference, etc.)</i>
Discipline:	

Design Component	Design Life or Return Period	Design Criteria + (Units)	Design Value Without Climate Change	Change in Design Value from Future Climate	Design Value Including Climate Change	Adaptation Cost Estimate (\$)	Comments / Notes / Deviations / Variances
Example Only: Culvert <3m	75 yr DL 100 yr RP	Rainfall Intensity (mm/h)	51.9	+40%	72.7	\$X	- See work including climate projections
Example Only: Culvert <3m	100 yr RP	Flow Rate (m <sup>3</sup> /s)	20	+10%	22	\$X	- See work including climate projections
Example Only: Bridge	200 yr RP	Flow Rate (m <sup>3</sup> /s)	82.8	+20%	99.3	\$X	- See work including climate projections

**Explanatory Notes / Discussion:**

*(Provide brief scope statement, purpose of project and what is being achieved. Enter comments for clarification where appropriate and provide justification and evidence of engineering judgment used for items where deviations are noted in the design parameters listed above or any other deviations which are not noted in the table above.)*

Recommended by: Engineer of Record: \_\_\_\_\_  
*(Print Name / Provide Seal & Signature)*

Date: \_\_\_\_\_

Engineering Firm: \_\_\_\_\_

Accepted by BCMoTI Consultant Liaison: \_\_\_\_\_  
 (For External Design)

Deviations and Variances Approved by the Chief Engineer: \_\_\_\_\_  
 Program Contact: Dirk Nyland, Chief Engineer BCMoTI

MoTI Section	1010		TAC Section	Not Applicable
--------------	------	--	-------------	----------------

**This page is  
intentionally left blank**



## 1020 HYDROLOGY

### 1020.01 MAPPING RESOURCES

#### Topographic Mapping

Many rural and urban areas have 1:5000 or 1:10000 topographic mapping with 2 m and 10 m contour intervals. TRIM mapping at 1:20000 and 20 m contour intervals, prepared by GeoBC, Ministry of Forests, Lands, Natural Resource Operations & Rural Development, are available in digital files or as paper prints. National Topographic Series (NTS) mapping at scales of 1:50000 and 1:250000 are also available.

Site inspections and air photo interpretation, and online GIS mapping should also be used wherever possible.

For information on:

- ◆ Air Photos  
<http://www2.gov.bc.ca/gov/content/data/geographic-data-services/digital-imagery/air-photos>
- ◆ Topographical and TRIM Maps  
<http://www2.gov.bc.ca/gov/content/data/geographic-data-services/topographic-data/terrain>
- ◆ Online GIS Mapping  
<https://www2.gov.bc.ca/gov/content/data/geographic-data-services/web-based-mapping/imapbc>

#### Floodplain Mapping

Floodplain maps are available for over one hundred locations throughout the Province and show the area affected by the 200-year flood. The maps are generally drawn to a scale of 1:5000 with one meter contour intervals. The maps also show natural and man-made features of the area.

For information on:

- ◆ Web site - See [Floodplain Maps](#)
- ◆ Purchase of Floodplain Maps – See <http://www.crownpub.bc.ca/>

### 1020.02 WATERSHED CHARACTERISTICS

#### Drainage Area

The drainage area should be determined from contour maps assuming that water will flow at right angles to the contours. The influences of ditches and roads must be taken into account as well as other features that could divert runoff from the natural runoff channels shown by the contours. The drainage area is usually expressed in units of hectares (ha) or square kilometres (km<sup>2</sup>).

#### Land Use

Watershed land use changes anticipated to occur within the design service life should be considered. Official Settlement Plans, which may consider up to 20 years of future planning, are available from the Regional Districts or the local municipalities.

Baseline Thematic mapping showing present land use at a scale of 1:250,000 is available in paper or digital format.

For information on Baseline Thematic mapping, see:

- ◆ [Geographic Data & Services](#)

#### Runoff Coefficients

In selecting the runoff coefficients (C), the land should be considered to be developed to the limit of its zoning. For smaller drainage areas, detailed land use information may be available resulting in a more precise estimate of the runoff coefficients. With larger drainage basins only general information is usually available resulting in the need to use conservative assumptions of the runoff coefficients.

The runoff coefficients shall be selected based on the design storm generating mechanisms. Whenever possible, the designer should check the reasonableness of coefficients against published flow records, the hydraulic performance of existing drainage infrastructure and the hydraulic geometry of the channel in question. **Table 1020.A** presents

MoTI Section	1020	TAC Section	Drainage Manual Ch. 2
--------------	------	-------------	-----------------------

conservative C values for **coastal type drainage basins** where the maximum runoff occurs as a result of fall and winter rains.

For a given watershed, C is applicable for storms up to a 10-year return period and is considered maximum for storm durations equal to or greater than the time of concentration of the basin. For rainstorms with a return period > 25 years, C may be slightly higher.

The value of C can increase above 1.0 if snowmelt is considered in addition to rainfall. Often in B.C. coastal watersheds, a light snowpack may be present when a heavy rainfall occurs. To account for rain induced snowmelt during the storm, C can be increased by 0.1 to a maximum value of 1.1 to estimate the total peak runoff.

The bottom three lines of Table 1020.A provide additions to the value of C as determined from the upper portion of the table. These additions are for high return period rainstorms and for snowmelt.

However, it must be noted that C cannot exceed 1.00 for rainfall alone or 1.10 for rainfall plus snowmelt.

For **small interior drainage basins** where the critical runoff events are generally a result of summer rainstorms, the runoff coefficients can be selected from the following:

- *RTAC Drainage Manual Volume 1 (1982), Table 2.4.1-2.4.3, p. 2.22*

For information on runoff coefficients, refer to:

- ◆ *RTAC Drainage Manual Volume 1 (1982), p. 2.22*
- ◆ Ministry of Environment (MoE) *Manual of Operational Hydrology in British Columbia*, Second Edition (1991)
- ◆ Caltrans *Highway Design Manual*, Figure 819.2A, 2015

**Table 1020.A Maximum Runoff Coefficient Values For Coastal Type Basins**

(source: Ministry of Environment, Manual of Operational Hydrology in British Columbia, Second Edition, 1991)

Watershed Physiography	Surface Cover				
	Impermeable	Forested	Agricultural	Rural	Urban
mountain (>30%)	1.00	0.90	-	-	-
steep slope (20-30%)	0.95	0.80	-	-	-
moderate slope (10-20%)	0.90	0.65	0.50	0.75	0.85
rolling terrain (5-10%)	0.85	0.50	0.40	0.65	0.80
flat (<5%)	0.80	0.40	0.30	0.55	0.75
return period 10-25 years	+0.05	+0.02	+0.07	+0.05	+0.05
return period > 25 years	+0.10	+0.05	+0.15	+0.10	+0.10
snowmelt	+0.10	+0.10	+0.10	+0.10	+0.10

**SCS Soil Groups and Curve Numbers**

Hydrologic soil groups and soil/land use curve numbers (CN) can be obtained from the following:

- Ministry of Environment (MoE) Soils Maps
- textural classifications provided by geotechnical investigations
- *CSPI Modern Sewer Design (1996), p. 67*

- *CSPI Handbook of Steel Drainage and Highway Construction Products (2010), p.109*

In areas where flooding is usually the result of winter precipitation (e.g. coastal areas), curve numbers should generally correspond to Antecedent Moisture Condition III (AMC III) to reflect the highest runoff potential. In areas where critical runoff values are the result of summer

MoTI Section	1020	TAC Section	Drainage Manual Ch. 2
--------------	------	-------------	-----------------------

storms (e.g. interior areas), Antecedent Moisture Condition II should be assumed.

For information on SCS soil groups and curve numbers, refer to:

- ◆ *CSPI Modern Sewer Design (1996), p. 68 & 69*
- ◆ *CSPI Handbook of Steel Drainage and Highway Construction Products (2010), p. 108*

### 1020.03 BASIN AND CHANNEL SLOPE

For small drainage areas, the slope of the drainage area can be estimated using the following formula:

$$s = \frac{h_1 - h_2}{L}$$

- s is the average slope of drainage area, m/m
- $h_1$  is the maximum elevation of drainage basin, m
- $h_2$  is the minimum elevation of drainage basin, m
- L is the maximum length of drainage path, m

Vertical drops such as falls and rapids, etc. should be deducted from the calculations.

For large or complex drainage areas, the main channel slope should be estimated using the Average Slope Method or the Equivalent Slope Method.

#### Average Slope Method

The Average Slope Method is recommended for normal use. It should give reasonable results for streams having short rapids or falls. However, it is not recommended for profiles which are strongly convex or concave for much of their length.

For information on the Average Slope Method, refer to:

- ◆ *RTAC Drainage Manual Volume 1 (1982), p. 2.11*

#### Equivalent Slope Method

The Equivalent Slope Method is recommended for streams which have intermediate steep sections totaling over 10 percent of the overall length.

For information on the Equivalent Slope Method, refer to:

- ◆ *RTAC Drainage Manual Volume 1 (1982), p. 2.13*

### 1020.04 TIME OF CONCENTRATION

For most drainage basins (e.g. those not effected by retention or detention), the “time of concentration” is defined as the time required for the surface runoff from the most remote part of the drainage basin to reach the point of concentration being considered. For very small basins, the following minimum times of concentration are recommended:

urban	5 minutes
residential	10 minutes
natural, undeveloped	15 minutes

#### Water Management Method

This method was developed by the Ministry of Environment, Water Management Division, Hydrology Section and is shown in **Figure 1020.B**. This method is limited to drainage areas up to 10 km<sup>2</sup> when used with the BC Rational Formula and for drainage areas up to 10 km<sup>2</sup> for the SCS Unit Hydrograph Method. The time of concentration is dependent on the basin characteristics. The following parameters should be considered:

flat	approximately 0% slope
rolling	approximately 1% slope
moderate	approximately 2.5% slope
steep	greater than 10% slope

For agricultural and rural basins, the curves labeled flat and rolling should be used. For forested watersheds, the curves labeled rolling, moderate and steep should be used.

MoTI Section	1020	TAC Section	Drainage Manual Ch. 2
--------------	------	-------------	-----------------------

Figure 1020.B Time of Concentration

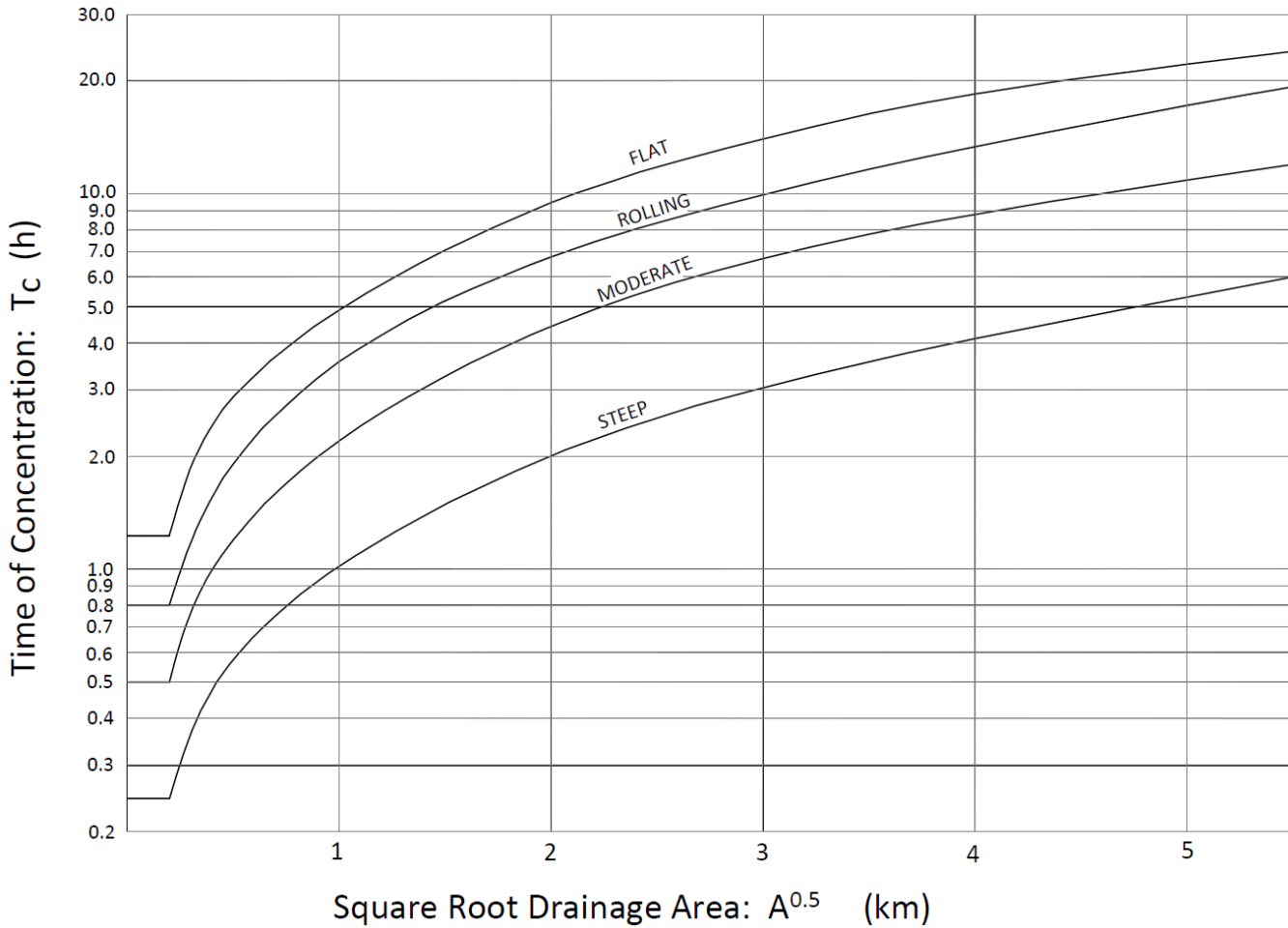

**Kirpich Formula**

This method can be used to estimate the time of concentration for natural basins with well defined channels, for overland flow on bare earth, and mowed grassed roadside channels. For overland flow, grassed surfaces, multiply  $t_c$  by 2. For overland flow, concrete or asphalt surfaces, multiply  $t_c$  by 0.4.

$$t_c = \frac{0.00032 L^{0.77}}{S^{0.385}}$$

- $t_c$  is the time of concentration, hr
- $L$  is the total stream length from the most remote part of the basin as extended from the stream source to the divide, m
- $S$  is the average slope of the total stream length, m/m

For information on the Kirpich Formula, refer to:

- ◆ *CSPI Handbook of Steel Drainage and Highway Construction Products (2010), p. 116*

MoTI Section	1020	TAC Section	Drainage Manual Ch. 2
--------------	------	-------------	-----------------------

### Hathaway Formula

This method can be applied to small urban or agricultural catchments and to small interior basins with light forest.

$$t_c = \frac{(rL)^{0.467}}{1.65 S^{0.234}}$$

$t_c$  is the time of concentration, hr

$L$  is the total stream length from the most remote part of the basin as extended from the stream source to the divide, km

$S$  is the average slope of the total stream length, m/m

$r$  is the roughness coefficient

The following table presents roughness coefficients which are recommended for use with the Hathaway formula.

Surface Cover	$r$
smooth, impervious	0.02
smooth, bare packed soil	0.10
poor grass, row crops	0.20
rough, bare soil	0.30
pasture, range land	0.40
deciduous timber land	0.60
coniferous timber land	0.70
timber land with deep litter	0.80

### Other Methods

Other methods of estimating the time of concentration for small and large watersheds include:

- Uplands Method
- SCS Curve Number Method
- Bransby Williams Formula

Time of concentration in channels and conduits can be estimated using Manning's Equation, the Continuity Equation and first principles.

For further information on time of concentration and estimating the time of concentration, refer to:

- ◆ *RTAC Drainage Manual Volume 1 (1982), p. 2.23*
- ◆ *MoE Manual of Operational Hydrology in British Columbia, Second Edition (1991)*
- ◆ *CSPI Handbook of Steel Drainage and Highway Construction Products (2010), p. 114*

## 1020.05 PRECIPITATION

### Intensity Duration Frequency Curves

Rainfall intensities can be obtained from Intensity-Duration-Frequency (IDF) curves which are published by the Meteorological Service of Canada (MSC). MSC offers software and data for printing and plotting IDF data.

MSC IDF curve data is less common in high elevation, mountainous areas and should be used with caution where snowmelt is a significant contributing factor to flood events.

For general information on IDF curves, refer to:

- ◆ *RTAC Drainage Manual Volume 1 (1982), p. 2.15*

For IDF curves at particular locations, refer to:

[http://climate.weather.gc.ca/prods\\_servs/engineering\\_e.html](http://climate.weather.gc.ca/prods_servs/engineering_e.html)

### Remote Locations

For remote locations where published IDF curves are not available, but hourly rainfall records exist, IDF curves can be developed by approved means. The Rainfall Frequency Atlas of Canada (Hogg et al., 1985) may provide the best interpolations of extreme rainfall statistics in BC. Information extracted from this reference document shall be evaluated to ensure the applicability of the climate characteristics in recent years.

### Design Storm

A design storm hyetograph or precipitation pattern, rather than a single point from IDF values, is required for many unit hydrograph methods and simulation models. The design storm pattern may be either historical (e.g. as actually recorded) or synthetic (e.g. as recreated from statistical summaries).

Synthetic design storm hyetographs can be incorporated into the following methods to produce design hydrographs:

- BC Rational Formula Method
- SCS Curve Number Method
- SCS Triangular Hydrograph Method
- Simulation Models

For information on design storms, refer to:

- ◆ *RTAC Drainage Manual Volume 1 (1982), p. 2.19*
- ◆ *Hydrology of Floods in Canada (Watt et al., 1989)*

MoTI Section	1020	TAC Section	Drainage Manual Ch. 2
--------------	------	-------------	-----------------------

## 1020.06 DESIGN FLOW CALCULATION METHODS

### Small Drainage Areas

For urban watersheds up to 1 km<sup>2</sup>, and for rural watersheds up to 10 km<sup>2</sup>, the Rational method may be suitable to calculate design flow. However, this method may become less reliable at the upper half of the rural watershed size ranges. The designer should use other methods for comparison, where feasible, to confirm the order of magnitude for the design flow. Some other methods are outlined in the following paragraphs.:

$$Q_p = \frac{CiA}{360}$$

- Q<sub>p</sub> is the peak flow, m<sup>3</sup>/s
- C is the runoff coefficient
- i is the rainfall intensity = P/T<sub>c</sub> mm/hr
- P is the total precipitation, mm
- T<sub>c</sub> is the time of concentration, hr
- A is the drainage area, ha

For information on the Rational Formula Method, refer to:

- ◆ *RTAC Drainage Manual Volume 1 (1982), p. 2.21*
- ◆ *MoE Manual of Operational Hydrology in British Columbia, Second Edition (1991)*

For drainage areas less than 10 km<sup>2</sup>, design flows can also be estimated using the following method:

- SCS Unit Hydrograph Method
- Streamflow Routing and Watershed Hydrologic Models

For information on the SCS Unit Hydrograph Method, refer to:

- ◆ *CSPI Modern Sewer Design (1996), p.67*
- ◆ *RTAC Drainage Manual Volume 1 (1982), Section 2.3.4*
- ◆ *MoE Manual of Operational Hydrology in British Columbia, Second Edition (1991)*

If the drainage areas approach the upper limits, efforts should be made to check the results using other methods (e.g. measured flow data, regional frequency analysis etc.) and confirmed with an on-site inspection of stream channel capacity.

### Large Drainage Areas

For large drainage areas (>10 km<sup>2</sup>), the recommended design flow calculation methods are:

- Station Frequency Analysis
- Regional Frequency Analysis

For the above noted calculation methods, the designer should determine the most appropriate statistical distribution(s) for the available data and the project site. Annual maximum average daily and maximum instantaneous flows are available from Water Survey of Canada (WSC) gauging stations.

For information on Station Frequency Analysis and Regional Frequency Analysis, refer to:

- ◆ *RTAC Drainage Manual Volume 1 (1982), p. 2.31, p. 2.35*
- ◆ *Hydrology of Floods in Canada (Watt et al., 1989)*
- ◆ *RTAC Guide to Bridge Hydraulics (2002)*
- ◆ *Regional Frequency Analysis*. Cambridge University Press (Hosking and Wallis, 1997).

Flood frequency analysis can be carried out using commercially available software.

### Design Flow Estimate

In some instances, more than one design flow calculation method should be used. The designer should evaluate all the results and establish an estimate of the design flow based on the reliability of input data, past events, historic high flow records, channel hydraulic geometry and experience.

## 1020.07 HYDROLOGY EXAMPLE

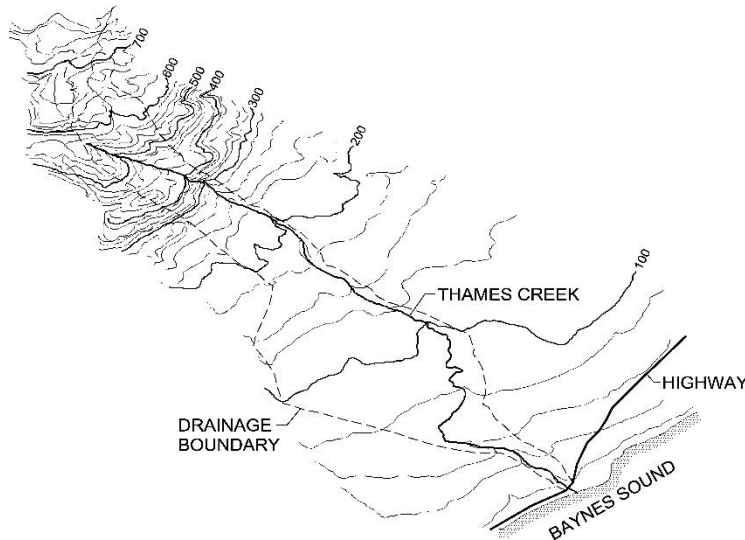

### Background

Thames Creek is located on the east side of Vancouver Island near Denman Island.

### Problem

Since the highway crosses the natural watercourse of Thames Creek, a bridge or culvert will be required. Estimate the 200-year ( $Q_{200}$ ) flow.

### Solution

#### Step 1 – Determine Design Flood Generation Mechanism

The Thames Creek watershed has a generally flat terrain except near the headwater regions. Peak flows are predominately generated by rainfall during the winter months.

Annual peak flows recorded at nearby hydrometric stations with similar watershed characteristics usually occur from October to April.

#### Step 2 - Determine Basin Size and Creek Length

From the 1:50000 scale mapping, the following dimensions were measured:

$$A = 6.6 \text{ km}^2 = 660 \text{ ha}$$

$$L = 8.2 \text{ km}$$

#### Step 3 - Determine Basin Slope

A profile of the main channel was plotted. Since the upper portion of basin is steep, the basin slope was estimated using the Equivalent Slope Method.

$$s = 0.051 \text{ m/m} = 5.1\%$$

#### Step 4 - Determine Land Characteristics

Design flows are estimated assuming worst case conditions. Considerations include basin slope, type

of vegetation, recurrence intervals, snowmelt, antecedent moisture condition (AMC) etc. Since the Thames Creek basin is relatively low with light forest cover, the following land characteristic values were selected:

$$r = 0.60, \text{ deciduous timber land}$$

$$CN = 85, \text{ forest land with good cover, Hydrologic Soil Group C, AMC III}$$

$$C = 0.40, \text{ flat, forested}$$

#### Step 5 - Determine Time of Concentration

There are numerous ways of estimating the time of concentration ( $t_c$ ). A few different methods will be used and an “average” value will be selected.

##### Method 1 - BC Rational Formula Method

$$\sqrt{A} = \sqrt{6.6 \text{ km}^2} = 2.6 \text{ km}$$

$$t_c = 3.6 \text{ hr (interpolated)}$$

##### Method 2 - Hathaway Formula

$$t_c = \frac{(rL)^{0.467}}{1.65s^{0.234}} = \frac{((0.60)(8.2 \text{ km}))^{0.467}}{1.65(0.051 \text{ m/m})^{0.234}} = 2.6 \text{ hr}$$

##### Method 3 - SCS Curve Number Method

$$SCN = 254 \left( \frac{100}{CN} - 1 \right) = 254 \left( \frac{100}{85} - 1 \right) = 44.8$$

MoTI Section	1020	TAC Section	Drainage Manual Ch. 2
--------------	------	-------------	-----------------------

$$T_L = \frac{L^{0.8} (0.039S_{CN} + 1)^{0.7}}{735 s^{0.5}}$$

$$= \frac{(8200m)^{0.8} (0.039(44.8) + 1)^{0.7}}{735(5.1\%)^{0.5}} = 1.7 \text{ hr}$$

$$t_c = 1.7T_L = 1.7(1.7hr) = 2.8hr$$

**Method 4 - Bransby Williams Formula**

$$t_c = \frac{0.605L}{s^{0.2} A^{0.1}} = \frac{0.605(8.2km)}{(5.1\%)^{0.2} (6.6km^2)^{0.1}} = 3.0hr$$

Taking an “average”, it is assumed that  $t_c = 3$  hours.

**Step 6 - Determine Rainfall Intensity**

The nearest rainfall gauging station is located at Comox Airport (El. 24 m). Since the basin elevation varies from El. 20 m to El. 760 m, a precipitation gradient is expected. The 10-year rainfall intensity corresponding to the time of concentration will be used due to the increased reliability of rainfall data over more frequent return periods (e.g. 2-year). A previous hydrological study estimated the average intensity over the basin will increase at a rate of 5% per 100 m rise in elevation.

$$i = (9mm / hr) \left( \left( \frac{740m}{100m} \right) (0.5)(0.05) + 1 \right) = 10.7mm / hr$$

**Step 7 - Determine Design Flow**

There are numerous ways of estimating the design flow. A couple different methods will be used.

**Method 1 - Rational Formula**

Since the basin is small and there is limited data, the Rational Formula will be used to determine the 10-year flow. The 10-year flow will then be converted to a 200-year flow. Studies have shown that the  $Q_{200}/Q_{10}$  ratio is approximately 1.7 for this region.

$$Q_{10} = \frac{CiA}{360} = \frac{(0.40)(10.7mm / hr)(660ha)}{360}$$

$$= 7.9m^3 / s$$

$$Q_{200} = 1.7Q_{10} = 1.7(7.9m^3 / s) = 13.4m^3 / s$$

**Method 2 - Regional Frequency Analysis**

Regional frequency analysis was conducted using flow data recorded at nearby hydrometric stations with watershed characteristics and flood generating mechanism similar to Thames Creek.

$$Q_{10} = 9.1m^3/s$$

$$Q_{200} = 15.5m^3/s$$

$$Q_{200}/Q_{10} = 1.7$$

**Step 8 – Incorporate Future Climate Projection Estimate to Design Flow**

The anticipated serviceable life of bridges and culverts is 75 years.

The future climate simulation of the Comox Airport rainfall station shows an increase in precipitation by up to 50% for the 2100’s time horizon. Therefore, the design flow estimated using the rational method is increased by 50% to account for future climate allowance.

$$Q_{200} = 13.4m^3/s + 50\% = 20.1m^3/s$$

Similarly, the hydrologic flow simulation of nearby watersheds shows a 45% increase for the 2100’s time horizon. So the design flow estimated using the regional frequency analysis method is increased by 45%.

$$Q_{200} = 15.5m^3/s + 45\% = 22.5m^3/s$$

Since the results do not vary significantly, an “average” will be taken. The 200-year flow is estimated to be 21.3 m<sup>3</sup>/s.



## 1030 OPEN CHANNEL DESIGN

### 1030.01 DESIGN RETURN PERIODS

For open channel design return periods, refer to Section 1010.02.

### 1030.02 OPEN CHANNEL CHARACTERISTICS

Highway ditch designs typically accommodate right-of-way drainage, which may include runoff from pavement areas, cut slopes and adjacent overland flow. Conversely, drainage channels are specifically designed for larger drainage basins and watercourses. Drainage channel design may incorporate the following considerations: hydraulic requirements, river engineering and geomorphology concepts, fisheries enhancement works, etc.

For typical earth ditch sections, ditch sections in solid rock cuts and median sections, refer to:

- ◆ *BC Supplement to TAC Geometric Design Guide, Fig. 440.A, B, C, D & H*

For geometric properties of various open channels, refer to:

- ◆ *RTAC Drainage Manual Volume 1 (1982), p. 3.4*
- ◆ *TAC Guide to Bridge Hydraulics (2001), Ch. 4, Sections 4.1 and 4.2*

#### Grades

Roadside drainage ditch grades do not necessarily need to be the same as the road profile. The desirable minimum sustained grade for channels is -0.5%, with -0.3% allowed as an absolute minimum to ensure drainage and prevent “standing water”.

Drainage channels may require steeper grades to ensure efficient transport of sediment and debris, in addition to flowing water. Steep channel grades should be checked for erodibility.

For information on ditch grades, refer to:

- ◆ *RTAC Drainage Manual Volume 1 (1982), p. 3.31*

#### Channel Depth

The roadside drainage ditch depth should be designed such that the ditch invert is a minimum 0.3 m below the bottom of the SGSB layer. The ditch should also be designed such that the flow does not frequently make contact with the SGSB layer. The maximum allowable depth of flow in minor ditches is 0.6 m.

The depth of drainage channels should be such that the design flow is contained at the roadway, with an allowance for freeboard.

The recommended minimum freeboard is 0.3 m for small drainage channels; larger channels should have a greater freeboard allowance.

For information on ditch depth, refer to:

- ◆ *RTAC Drainage Manual Volume 1 (1982), p. 3.31*

#### Channel Width

The bottom width of highway ditches varies and is dependent upon ditch shape, depth, slope, type of material and maintenance requirements. The bottom width of a roadside ditch should not normally be less than 1 m. However, for major roadways, this may be increased for safety purposes to approximately 2 m.

The width of drainage channels should be such that the design flow is contained at the highway and efficient transport of sediment and debris is maintained.

For information on channel width, refer to:

- ◆ *RTAC Drainage Manual Volume 1(1982), p. 3.31.*
- ◆ *TAC Guide to Bridge Hydraulics (2001), Ch. 4, Section 4.2*

#### Sideslopes

Typical channel sideslopes range between 1.5:1 (H:V) to 4:1. Ditch sideslopes steeper than 2:1 are generally difficult to maintain.

MoTI Section	1030	TAC Section	RTAC Drainage Manual Ch.3
--------------	------	-------------	---------------------------

Where drainage channel banks tie into natural channel banks, the sideslopes should be adjusted locally to ensure a smooth transition.

For information on sideslopes, refer to:

- ◆ *BC Supplement to TAC Geometric Design Guide, Fig. 440.A, B, C, D & H*

**Roughness Coefficients**

Manning’s roughness coefficients (n) are commonly used to describe channel and conduit characteristics.

For Manning’s roughness coefficients, refer to:

- ◆ *RTAC Drainage Manual Volume 1 (1982), Table 3.2.3, p. 3.12*

For information on Manning’s roughness coefficients, refer to:

- ◆ *RTAC Drainage Manual Volume 1 (1982), p. 3.10*

**Assessment of Existing Channel**

An existing channel should be analyzed to determine if there is sufficient capacity to accommodate the design flow, as well as sediment and debris transport. If channel capacity is insufficient, drainage problems may occur at unexpected locations during large flood events. In addition, channel stability and debris loads should also be assessed.

**1030.03 FORMULAE FOR OPEN CHANNELS**

**Manual Calculations**

Capacity, discharge, depth of flow and velocity for uniform and non-uniform sections such as conduits and ditch channels can be approximated through an iterative process involving Manning’s Equation and the Continuity Equation. A water surface profile can be approximated and is dependent on whether the flow depth, as determined by Manning’s Equation, is greater or less than the critical flow depth for the channel.

The Manning’s Equation is as follows:

$$v = \frac{R^{0.67} S^{0.5}}{n}$$

- v is the average flow velocity, m/s
- R is the hydraulic radius = A/P, m
- A is the cross sectional area of flow, m<sup>2</sup>
- P is the wetted perimeter, m
- S is the friction or channel slope, m/m
- n is the Manning’s roughness coefficient

For information on Manning’s Equation, refer to:

- ◆ *RTAC Drainage Manual Volume 1 (1982), p. 3.10*

The Continuity Equation is as follows:

$$Q = vA$$

- Q is the discharge, m<sup>3</sup>/s
- v is the average flow velocity, m/s
- A is the cross sectional area of flow, m<sup>2</sup>

For information on the Continuity Equation, refer to:

- ◆ *RTAC Drainage Manual Volume 1 (1982), p. 3.3*

**Critical Flow**

Subcritical flow occurs on mild slopes or in backwater areas, while supercritical flow occurs on steep slopes. The Froude number (F) will determine whether the flow is subcritical (F<1), critical (F=1) or supercritical (F>1). The Froude number formula is as follows:

$$F = \frac{v}{\sqrt{gy_h}}$$

- F is the Froude number
- v is the average flow velocity, m/s
- g is the gravitational acceleration, m/s<sup>2</sup>
- y<sub>h</sub> is the hydraulic depth = A/B, m
- A is the cross sectional area of flow, m<sup>2</sup>
- B is the width of flow at the water surface, m

For information on critical flow, refer to:

- ◆ *RTAC Drainage Manual Volume 1 (1982), p. 3.5*

**Water Surface Profiles**

Natural drainage channels tend to be highly irregular in shape so a simple analysis using Manning’s equation, while helpful for making an approximation, is not sufficiently accurate to determine a river water surface profile. The following one-dimensional analysis program is recommended:

MoTI Section	1030	TAC Section	RTAC Drainage Manual Ch.3
--------------	------	-------------	---------------------------

- ◆ HEC-RAS (V. 5.03 or later)

The above numerical model has been developed by the US Army Corps of Engineers.

For information on water surface profiles, refer to:

- ◆ *RTAC Drainage Manual Volume 1 (1982), p. 3.15*
- ◆ *TAC Guide to Bridge Hydraulics (2001), Ch. 4, Section 4.3*

### 1030.04 CHANNEL LINING

A variety of channel liners including grass and riprap are used where channel slopes are steep. If flow velocities are high, erosion may be a potential problem. The treatment of highway runoff may also be necessary. Where the grade is -1% and steeper, the erodibility of the channel material should be checked against the flow velocity and depth. Methods used for the design of erodible channels include:

- maximum permissible velocity
- maximum permissible tractive force

For maximum permissible values, see the following page for **Table 4.3** from *CSPI Handbook of Steel Drainage and Highway Construction Products (2010)*.

For a qualitative evaluation of various types of channel lining, also refer to:

- ◆ *RTAC Drainage Manual Volume 1(1982), Table 3.3.2, p. 3.25*
- ◆ *TAC Guide to Bridge Hydraulics (2001), Ch. 4, Sections 4.4.1, 4.4.2 and 4.4.6 to 4.4.8; Ch. 5*

### Unlined Channels

Unlined channels exist during construction and may be a potential problem if erodible soils are present. Temporary ground protection or a sediment control plan may be required until sufficient vegetation has developed. Erosion and sediment control structures shall be designed according to DFO/MoE guidelines.

For competent mean velocities for cohesionless soils, refer to:

- ◆ *RTAC Drainage Manual Volume 1 (1982), Figure 3.3.1, p. 3.23*

For information on erosion and sediment control, refer to:

- ◆ *Fisheries and Oceans - Land Development Guidelines for Protection of Aquatic Habitat (1993), p. 23*

### Grassed-Lined Channels

All cut and fill slopes are generally seeded. Small grass-lined channels usually require a minimum slope of -0.5% to function properly. Grass-lined channels are generally sufficient where the treatment of highway runoff is required.

For maximum permissible velocities in vegetal-lined channels, see the next page for **Table 4.4** from *CSPI Handbook of Steel Drainage and Highway Construction Products (2010)*.

For information on grass-lined channels, also refer to:

- ◆ *RTAC Drainage Manual Volume 1 (1982), p. 3.24.*

MoTI Section	1030	TAC Section	RTAC Drainage Manual Ch.3
--------------	------	-------------	---------------------------

**Table 4.3** Comparison of limiting water velocities and tractive force values for the design of stable channels (straight channels after aging; channel depth = 1m)

Material	n	For Clear Water		Water Transporting Colloidal Silts	
		Velocity, m/s	Tractive Force, Pa	Velocity, m/s	Tractive Force, Pa
		Fine sand colloidal	0.020	0.46	1.29
Sandy loam noncolloidal	0.020	0.53	1.77	0.78	3.59
Silt loam noncolloidal	0.020	0.61	2.30	0.91	5.27
Alluvial silts noncolloidal	0.020	0.61	2.30	1.07	7.18
Ordinary firm loam	0.020	0.76	3.59	1.07	7.18
Volcanic ash	0.020	0.76	3.59	1.07	7.18
Stiff clay very colloidal	0.025	1.14	12.45	1.52	22.02
Alluvial silts colloidal	0.025	1.14	12.45	1.52	22.02
Shales and hardpans	0.025	1.83	32.08	1.83	32.08
Fine gravel	0.020	0.76	3.59	1.52	15.32
Graded loam to cobbles when non-colloidal	0.030	1.14	18.19	1.52	31.60
Graded silts to cobbles when colloidal	0.030	1.22	20.59	1.68	38.30
Coarse gravel non-colloidal	0.025	1.22	14.36	1.83	32.08
Cobbles and shingles	0.035	1.52	43.57	1.68	52.67

**Table 4.4** Maximum permissible velocities in vegetal-lined channels<sup>d</sup>

Cover Average, Uniform Stand, Well Maintained	Slope Range	Permissible Velocity <sup>a</sup>		
		Erosion Resistant Soils	Easily Eroded Soils	
		Percent	m/s	m/s
Bermudagrass	0 -5		2.44	1.83
	5-10		2.13	1.52
	over 10		1.83	1.22
Buffalograss Kentucky bluegrass Smooth brome Blue grama	0-5		2.13	1.52
	5-10		1.83	1.22
	over 10		1.52	0.91
Grass mixture <sup>b</sup>	0 -5		1.52	1.22
	5 -10		1.22	0.91
Lespedeza sericea Weeping lovegrass Yellow bluestem Kudzu Alfalfa Crabgrass	0 -5		1.07	0.76
Common lespedeza <sup>b</sup> Sudangrass <sup>b</sup>	0-5 <sup>c</sup>		1.07	0.76

<sup>a</sup> From "Handbook of Channel Design for Soil and Water Conservation:" Soil Conservation Service SCS-TP-61, Revised June 1954

<sup>b</sup> Annuals-used on mild slopes or as temporary protection until permanent covers are established.

<sup>c</sup> Use on slopes steeper than 5 percent is not recommended.

<sup>d</sup> Data for this table is a composite of data from several reference sources.

Source: CSPI Handbook of Steel Drainage and Highway Construction Products (2010)

MoTI Section	1030	TAC Section	RTAC Drainage Manual Ch.3
--------------	------	-------------	---------------------------

### Riprap Lining

Riprap is required where channel degradation and erosion is a concern. For ditches, the riprap will be placed on the sideslopes to a height of at least the design depth of the water. For natural drainage channels, riprap is usually placed 0.3 to 0.6 m above the design depth of water. A proper toe or key must also be provided at the bottom of any riprap bank protection. Riprap classification can be determined using **Figure 1030.A**. The gradation of riprap shall conform to Table 205-A of the Standard Specifications for Highway Construction.

For information on riprap lining, refer to:

- ◆ *TAC Guide to Bridge Hydraulics, (2001), Ch. 5*
- ◆ *RTAC Drainage Manual Volume 1 (1982), p. 3.24.*
- ◆ *MoE Riprap Design and Construction Guide (March, 2000)*  
[http://www.env.gov.bc.ca/wsd/public\\_safety/flood/pdfs\\_word/riprap\\_guide.pdf](http://www.env.gov.bc.ca/wsd/public_safety/flood/pdfs_word/riprap_guide.pdf)

### Filter Blanket

To protect relatively fine grained bank material from scour and sloughing, wave action and groundwater flow from sideslopes, a filter blanket of gravel or crushed rock, or geotextile shall be placed between the bank and riprap.

For gravel or rock filters, Brown and Clyde (1989) recommend the following sizing criterion:

$$D_{15c}/D_{85f} < 5 < D_{15c}/D_{15f} < 40$$

where  $D_{15}$  and  $D_{85}$  refer to the 15% and 85% sieve passing sizes, and subscripts "c" and "f" refer to the coarse and finer layers respectively. The criterion should be imposed at the interfaces between the underlying material and the filter, and between the filter and the overlying riprap. If a single filter layer cannot meet the criterion at both interfaces, two or more layers may be required.

For information on filter blankets, refer to:

- ◆ *TAC Guide to Bridge Hydraulics, (2001); Ch. 5., Section 5.4.3*
- ◆ *MoE Riprap Design and Construction Guide (March, 2000)*

## 1030.05 OPEN CHANNEL STRUCTURES

The design of open channel structures such as weirs and ditch blocks must address safety issues and also consider their location relative to the roadway.

### Check Dams/Drop Structures

To prevent erosion and degradation of the stream beds, check dams or drop structures may be required in a channel where the topography is steeper than the desired channel slope. The structure should be lower in the middle than the edges (notched), and riprap protection should be provided to prevent erosion around the bank ends and undermining of the toe.

For information on check dams/drop structures, refer to:

- ◆ *TAC National Guide to Erosion and Sediment Control on Roadway Projects, (2005)*

### Ditch Blocks

Where the ditch grade is steeper than -2%, a ditch block should be located downstream of the culvert inlet to provide a sump and direct flows into the culvert. Provision for a sump may require the sacrifice of the ditch slope, the cutslope or the ditch bottom width.

An option for creating a sump is to steepen up the road fill slope somewhat without varying the back cutslope location. Ditch blocks may be constructed using concrete filled sandbags or by using a berm protected with riprap.

Clear Zone requirements preclude the traditional vertical faced ditch block design. Barrier protection or traversable ditch blocks may be needed.

MoTI Section	1030	TAC Section	RTAC Drainage Manual Ch.3
--------------	------	-------------	---------------------------

Figure 1030.A Riprap Design Chart

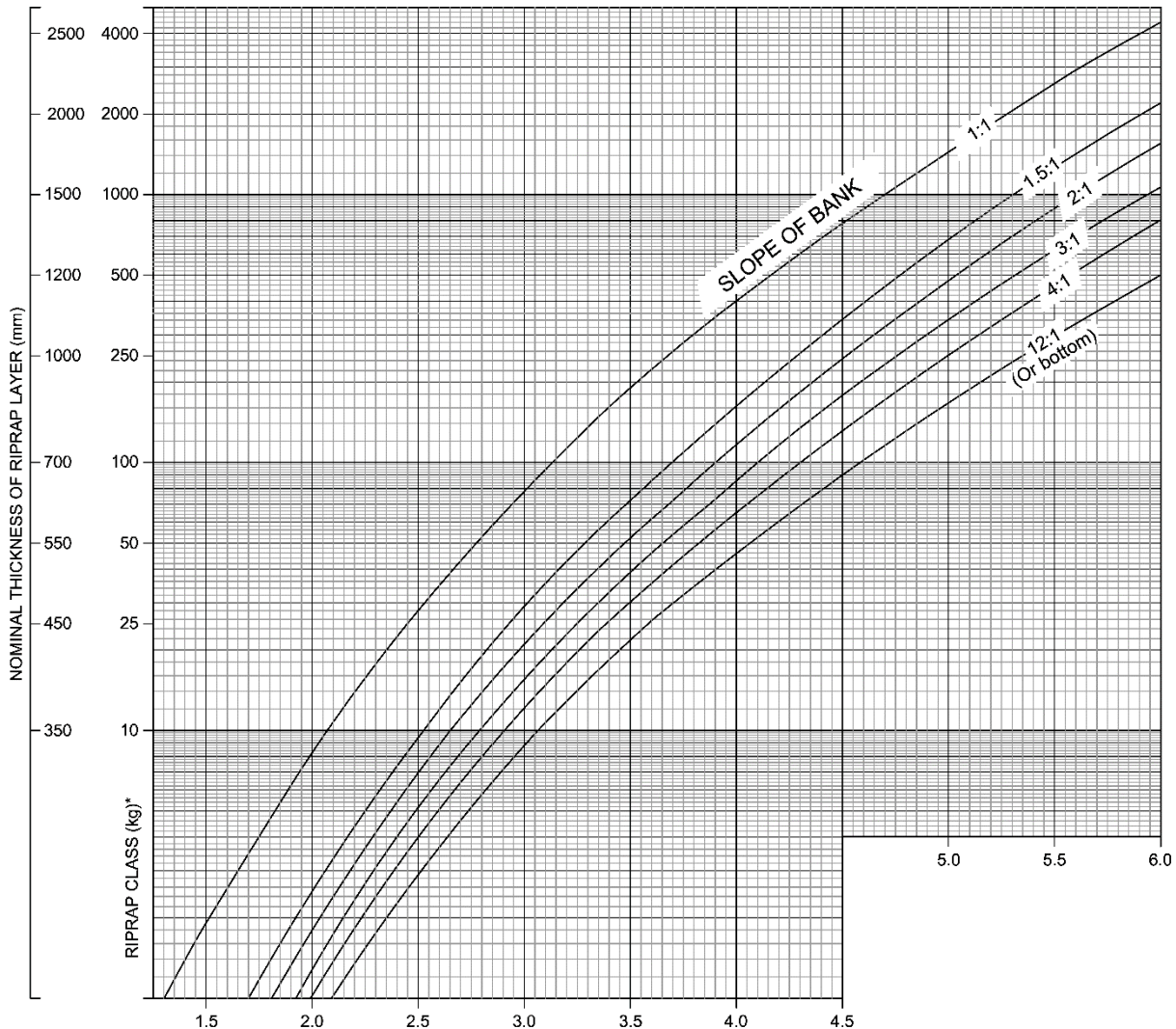

\*SEE NOTE No. 8

$V_s$  = VELOCITY AGAINST BANK (m/s)

SIZE OF ROCK AND THICKNESS OF PROTECTION BLANKET THAT WILL RESIST DISPLACEMENT FOR VARIOUS VELOCITIES AND BANKSIDE SLOPES.

Notes:

- Adapted from report of Sub-committee on slope protection, Am. Soc. Civil Engineers Proc. June 1948.
- Density of stone assumed at  $2,640 \text{ kg/m}^3$ .
- Enter graph at known velocity to intersection with desired slope curve. Move horizontally to required riprap class and thickness.
- $V_M$  = mean stream velocity.
- For parallel flow along tangent bank;  $V_s = 2/3 V_M$
- For impinging flow against curved bank;  $V_s = 4/3 V_M$
- For direct impingement on the bank;  $V_s = 2 V_M$
- \*8. The riprap class No. is the mass (kg) of the 50% rock size (i.e., at least half of the riprap must be heavier than its class mass). For details regarding the rock gradation see Standard Specifications - Section 205.02
- Do not interpolate between riprap classes. Use the next highest class.

## 1040 CULVERT DESIGN

### 1040.01 CULVERT DESIGNATION

Dimensions for culverts shall be shown in the following form for pipes less than 3000 mm diameter and equivalent:

XX m - YYY Ø ZZZ NN WT CC

Where XX is the total length of the culvert in metres; YYY is the Inside Diameter of the culvert in millimetres; ZZZ are the Initials for the Type of Culvert, which is normally:

CSP 68x13	Corrugated Steel Pipe
CSP 125x25	Corrugated Steel Pipe
SPCSP	Structural Plate Corrugated Steel Pipe
SPCSPA	Structural Plate Corrugated Steel Pipe Arch
SPCSA	Structural Plate Corrugated Steel Arch
CONC	Concrete Pipe
PVC	Poly Vinyl Chloride Pipe
HDPE	High Density Polyethylene Pipe
SWSP	Smooth Wall Steel Pipe

NN is the wall thickness (WT) in millimetres for steel pipe. The complete information shall be shown on the plan and profile drawings, although showing of the WT on the plan is optional. PVC and HDPE pipes shall have a minimum stiffness of 320 kPa.

CC is the coating type for CSP and mix type for concrete. PVC and HDPE shall not contain recycled materials. Typical coating materials are.

Gal	Galvanized
AL2	Aluminized Type 2
PL	Polymer Laminated

### 1040.02 CULVERT DESIGN CONSIDERATIONS

#### General

This section is intended for buried structures with spans less than 3000 mm. The Designer shall pay due regard to empirical methods, current practice, and manufacturer's literature and solutions that have a proven record of success for small diameter culverts.

The *Commentary on S6-14, Canadian Highway Bridge Design Code* (CHBDC) indicates that the provisions of Section 7 of the code apply only to buried structures with span ( $D_h$ ) greater than 3000 mm, but the CHBDC does not provide design guidance for smaller structures.

Contrary to the CHBDC reference to structures with a span >3000 mm, the BC MoTI *Bridge Standards and Procedures Manual, Supplement to CHBDC S6-14* refers to structures with a span  $\geq 3000$  mm. The latter dimension shall define when a structure must be designed in accordance with the CHBDC.

Buried structures with spans less than 3000 mm may also be designed to CHBDC S6-14 Section 7 (except that the design live load vehicle shall be the BCL-625 per the BC MoTI *Supplement to CHBDC S6-14*).

Specifications for materials, fabrication and construction of buried structures shall be in accordance with MoTI Standard Specifications SS 303 Culverts and SS 320 Corrugated Steel Pipe, where applicable.

#### Design Return Periods

For culvert design return periods, refer to **Table 1010.A**.

Examples of when various return periods should be used are as follows:

50 year	For low volume roads with shallow fill in undeveloped areas.
100 year	Normal design except when the conditions stated for the 200 year return period are applicable.
200 year	For highways in areas where flood damage is critical and where requested by MoE and FLNRO.

MoTI Section	1040	TAC Section	RTAC Drainage Manual Ch.4
--------------	------	-------------	---------------------------

### Culvert Locations

Culverts shall be located at existing watercourses, at low points and where “day lighting” the culvert outlet is feasible. The culvert must discharge into a natural watercourse or a properly designed channel that terminates at a natural watercourse or body of water. Culvert outflows must not be allowed to find their own route to down slope watercourses. For highway ditches in cut, culverts are generally spaced every 300 m.

For information on culvert locations, refer to:

- ◆ *RTAC Drainage Manual Volume 2 (1987), p. 4.12*
- ◆ *CSPI Handbook of Steel Drainage and Highway Construction Products (2010), p. 193*

### Culvert Types

Common culvert types include circular, pipe arch and rectangular box. Culvert selection will depend on factors such as availability, material costs, ease of installation, headroom, durability etc.

For information on culvert types, refer to:

- ◆ *RTAC Drainage Manual Volume 2 (1987), p. 4.3*

### Culvert Size

The following minimum culvert diameters are recommended:

- The minimum size culvert under a highway or main road shall be 600 mm diameter.
- The minimum size frontage road culvert shall be 500 mm diameter.
- The minimum size driveway culvert shall be 400 mm diameter.

A flow analysis shall be done to determine whether larger diameter culverts are required.

### Skew

A skew angle shall be designated for all installations. The skew angle is the angle measured from the centerline of the highway ahead to the centerline of the culvert, measured in a clockwise direction. The normal range is from 45 to 135 degrees.

A cross culvert from a highway ditch in cut shall be installed on a skew to facilitate inlet pickup.

Culverts conveying flow from a drainage channel should be aligned with the drainage channel.

For information on culvert skew, refer to:

- ◆ *CSPI Handbook of Steel Drainage and Highway Construction Products (2010), p. 199*

### Slope

Culverts should generally be placed on the stream grade. If possible, culverts should ideally be placed slightly steeper than the critical slope for the size and type of pipe used. This is usually between 1.0% and 2.2%. The desirable minimum gradient is 0.5% to prevent sedimentation within the barrel. The desired maximum gradient is 20% for CSP and 10% for concrete pipes.

For culverts on steep grades, the stability of the upstream bed material should be reviewed to assess whether the culvert invert will be abraded by the bed load. Additional features including thicker walls, wear resistant coatings, and armoured or paved inverts should be considered.

For culverts required to provide fish passage, the culvert slope may have to be less than 0.5% to minimize velocities. Special culvert enhancements to provide fish passage may also be considered.

In some instances, a culvert may be located at a grade change in a channel bed (e.g. break point between steep mountain flow and floodplain flow). This is the worst place for debris deposition therefore mitigative measures such as a debris basin, debris collection device or smooth flow transition should be considered.

For information on culvert slopes, refer to:

- ◆ *CSPI Handbook of Steel Drainage and Highway Construction Products (2010), p. 196*
- ◆ *RTAC Drainage Manual Volume 2 (1987), p. 4.12*
- ◆ *Land Development Guidelines for the Protection of Aquatic Habitat (1993), p. 73*

### Invert Elevations at Streams

Culvert inverts should be at least one quarter of the rise below the average natural channel bed up to a maximum depth of 1 m. Exceptions to the recommended invert depth may be considered when site specific features would require special attention (i.e. fish passage; bedrock).

For fish passage requirement, refer to:

- ◆ *Fish-stream Crossing Guidebook (MFLNRO 2012)*



MoTI Section	1040	TAC Section	RTAC Drainage Manual Ch.4
--------------	------	-------------	---------------------------

### Length

Culverts shall extend a suitable distance (typically 0.5 to 0.7 m) beyond the toe of slope to accommodate possible sloughing. If riprap is to be placed at the culvert ends, the end extensions should be adjusted accordingly. The total culvert length shall be rounded up to the nearest 1.0 m. CSP stock pipe lengths are 6 m, however, other lengths are available.

For a SPCSP or concrete box culvert, the extension beyond the toe may be greater due to the length of the prefabricated sections.

As part of final construction clean up, the embankment shall be built-up around the culvert end to limit protrusion to less than 150 mm. Culvert ends shall be step-beveled, where appropriate, to improve hydraulic efficiency.

For information on culvert length, refer to:

- ◆ *CSPI Handbook of Steel Drainage and Highway Construction Products (2010), p. 197*

### Wall Thickness and Height of Cover Requirements

Maximum and minimum height of cover and minimum wall thickness shall be per manufacturer's specifications. CSP wall thickness and height of cover are shown in **Tables HC-1 to HC-12** in the following:

- ◆ *CSPI Handbook of Steel Drainage and Highway Construction Products (2010)*

SPCSP, concrete pipe, and PVC/HDPE wall thickness shall be obtained from manufacturer specifications.

For culverts less than 3000 mm diameter, a minimum cover of 450 mm (measured from the finished shoulder grade) over the crown of the pipe is required. The minimum cover requirements may require a sump at the inlet. An increase in minimum height of cover may be required for heavy construction vehicle loading.

### Durability Constraints

For culverts larger than or equal to 1500 mm and located in a perennial natural watercourse, a diversion pipe shall be provided for maintenance flow diversion. The diversion pipe shall be sized for the 10-year maximum instantaneous flow during the construction period of the watercourse and have a minimum size of 300 mm. The inverts of the

diversion pipe shall be at least 600 mm higher than the primary culvert inverts.

If not specified otherwise in a design assignment, the structural design life of a culvert shall be 75 years. The flow water chemistry is a significant factor relating to the durability of pipe materials; however, economical pipe materials and coatings are available that perform well in BC waters. Water hardness, pH and Resistivity values should be obtained at each site to confirm environmental conditions. If water resistivity values are <1500 or >8000 ohm-cm, specialist advice should be obtained. Where abrasion and corrosion interferes with durability, a suitable coating or pipe material must be selected. In some applications, such as creeks with high bed load, armoured inverts, open bottom arches on concrete footings or concrete box culverts are recommended.

For information on Durability, refer to:

- ◆ *CSPI Handbook of Steel Drainage and Highway Construction Products (2010), Chapter 8*
- ◆ *RTAC Drainage Manual Volume 2 (1987)*

### Manning's Roughness Coefficient

The following roughness coefficients (n) are recommended for culverts:

**Table 1040.A Manning's Roughness Coefficient**

Pipe Material	Manning's "n"
CSP	Varies ~ 0.021 to 0.027
SPCSP	Varies ~ 0.027 to 0.033
concrete	0.012
PVC	0.009
SP	Varies ~ 0.01 to 0.015

For CSP and SPCSP, the roughness coefficient will depend on the depth of flow, pipe material, corrugation dimensions and whether the pipe is annular or helical. The above Manning's roughness coefficients can be confirmed from:

- *RTAC Drainage Manual Volume 1 (1982), Table 3.2.3, p. 3.12*
- *CSPI Handbook of Steel Drainage and Highway Construction Products (2010), Table 4-6, 4-7, p. 145, p. 146*

MoTI Section	1040	TAC Section	RTAC Drainage Manual Ch.4
--------------	------	-------------	---------------------------

### 1040.03 CULVERT HYDRAULICS

The following design criteria are recommended for typical culverts with span less than 3000mm:

- Inlet control headwater depth to diameter ratio (HW/D) shall not exceed 1.0 at the design flow.
- For natural watercourse with high debris and bedload, HW/D of no higher than 0.7 is recommended
- Outlet control headloss through a typical highway culvert shall be less than 0.3 m.

The minimum pipe gradient for inlet control and initial dimensions for circular steel pipe and steel pipe arch culverts can be determined using **Figure 1040.B** and **Figure 1040.C** respectively. A worked example for circular pipe is provided in **Figure 1040.D** and pipe-arch in **Figure 1040.E**.

The culvert operation must be checked for inlet and outlet control. The greater headwater depth (HW) will govern.

For information on culvert design procedures, refer to:

- ◆ *RTAC Drainage Manual Volume 2 (1987), p. 4.35*

Culverts providing fish passage shall be designed with reference to the Land Development Guidelines and the BC Water Sustainability Act.

For information on fish passage requirements, refer to:

- ◆ *Land Development Guidelines for the Protection of Aquatic Habitat (1993), p. 69*
- ◆ *RTAC Drainage Manual Volume 2 (1987), p. 4.107*
- ◆ *CSPI Handbook of Steel Drainage and Highway Construction Products (2010), p. 9*
- ◆ *Fish Stream Crossing Guidebook (2012)*

#### Check For Inlet Control

Headwater depths under inlet control ( $HW_{in}$ ) can be estimated using the following figures:

For circular CSP and SPCSP:

- *CSPI Handbook of Steel Drainage and Highway Construction Products (2010), Figure 4-10, p. 151*

An illustrative sample of the inlet control nomograph for circular pipes using CSPI Fig. 4-10 is presented in **Figure 1040.F**.

For CSP and SPCSP pipe arch:

- *CSPI Handbook of Steel Drainage and Highway Construction Products (2010), Figure 4-12, 4-13, 4-14, p. 153, p.154, p. 155*

For circular concrete pipe:

- *RTAC Drainage Manual Volume 2 (1987), Figure 4.7.7, p. 4.42*

For concrete box culvert:

- *RTAC Drainage Manual Volume 2 (1987), Figure 4.7.3, 4.7.4, p. 4.38, p. 4.39*

For further information on inlet control, refer to:

- ◆ *RTAC Drainage Manual Volume 2 (1987), p. 4.17.*
- ◆ *CSPI Handbook of Steel Drainage and Highway Construction Products (2010), p. 140*

#### Check For Outlet Control

Headloss (H) for full flow conditions can be estimated using the following figures:

For circular CSP and SPCSP:

- *CSPI Handbook of Steel Drainage and Highway Construction Products (2010), Figure 4-17, 4-18, p. 158, p. 159*

For CSP and SPCSP pipe arch:

- *CSPI Handbook of Steel Drainage and Highway Construction Products (2010), Figure 4-19, 4-20, p. 160, p. 161*

For circular concrete pipe:

- *RTAC Drainage Manual Volume 2 (1987), Figure 4.7.14, p. 4.48*

For concrete box culvert:

- *RTAC Drainage Manual Volume 2 (1987), Figure 4.7.13, p. 4.47*

MoTI Section	1040	TAC Section	RTAC Drainage Manual Ch.4
--------------	------	-------------	---------------------------

Headloss (H) for partially full flow conditions can be approximated using the *equation* from the *CSPI Handbook of Steel Drainage and Highway Construction Products (2010)*, p. 146, or *equation 4.5.4* from the *RTAC Drainage Manual Volume 2 (1987)*, p. 4.18

The headwater depth under outlet control ( $HW_{out}$ ) can be estimated using *CSPI Handbook of Steel Drainage and Highway Construction Products (2010)*, p. 143, or *equation 4.5.10* from the *RTAC Drainage Manual Volume 2 (1987)*, p. 4.20

For information on outlet control, refer to:

- ◆ *RTAC Drainage Manual Volume 2 (1987)*, p. 4.18
- ◆ *CSPI Handbook of Steel Drainage and Highway Construction Products (2010)*, p. 143

### Hydraulic Programs

Hydraulic computer programs have distinct advantages over hand calculations or nomographs for determining normal depth, culvert velocity, hydraulic radius and area of flow for partially full flow conditions.

- *CSPI Handbook of Steel Drainage and Highway Construction Products (2010)*, p. 150

The following one-dimensional analysis programs are recommended:

- ◆ HEC-RAS (V. 5.03 or later)
- ◆ HY-8 (V. 7.5 or later)

The above numerical models have been developed by the US Army Corps of Engineers and the US Federal Highway Administration, respectively. HEC-RAS has the advantage of being able to more effectively couple open-channel and closed-conduit flow simulations.

### Critical Flow

For information on critical flow, refer to **Section 1030.03**.

Figure 1040.B Hydraulic Design Chart For Circular Steel Pipe

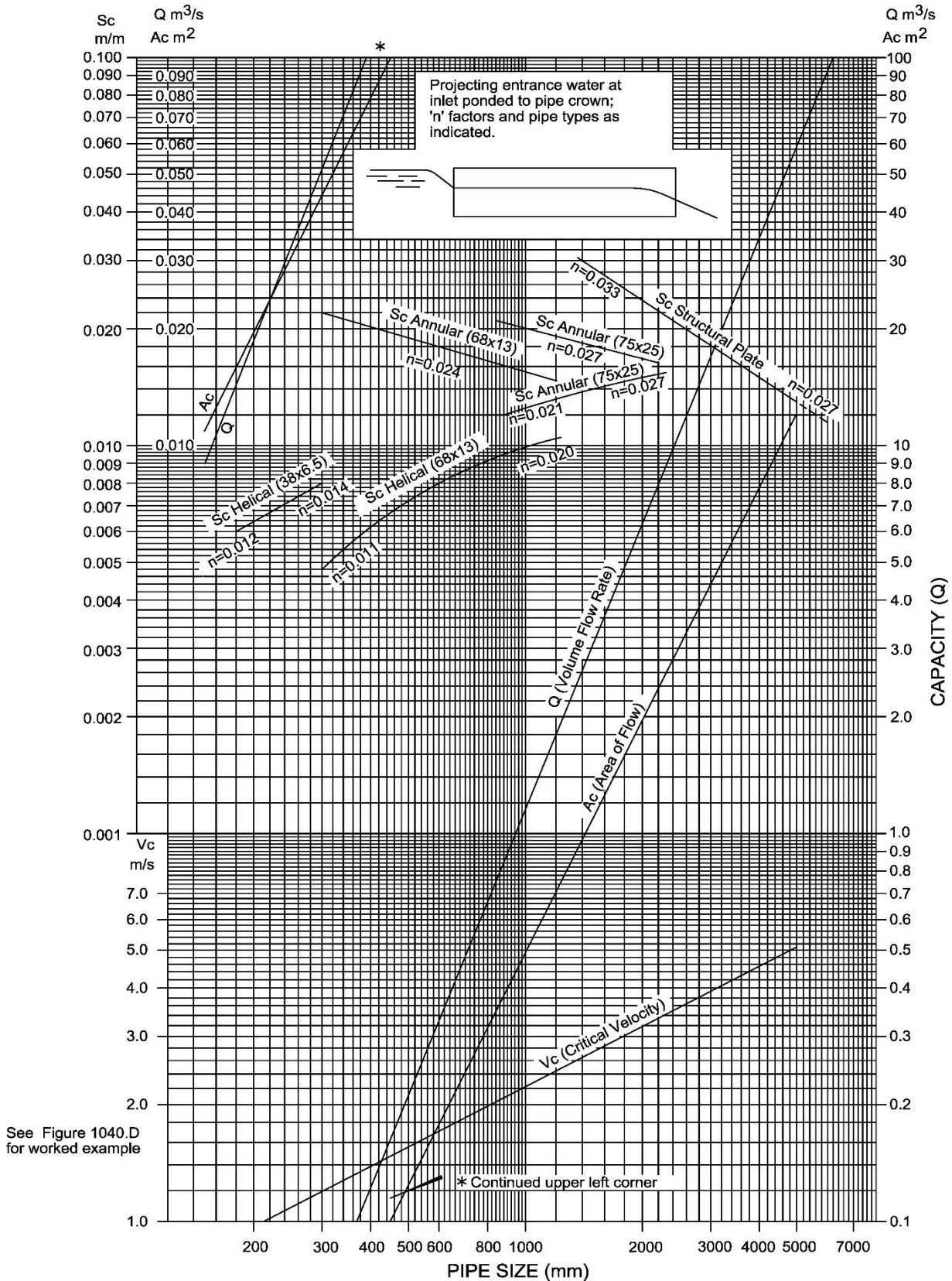

See Figure 1040.D for worked example

Figure 1040.C Hydraulic Design Chart for Corrugated Steel Pipe-Arch

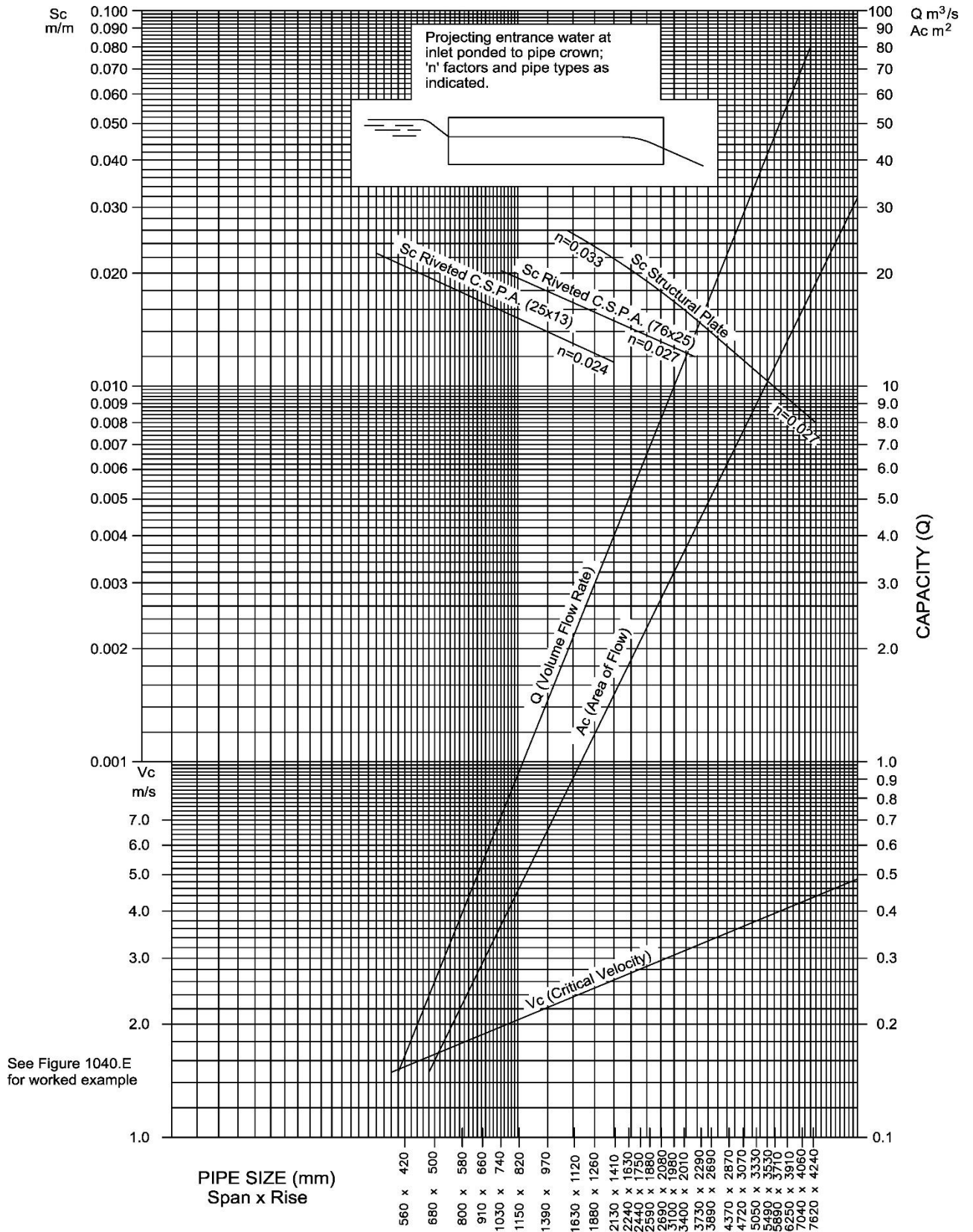

Figure 1040.D Hydraulic Sample Chart for Circular Steel Pipe

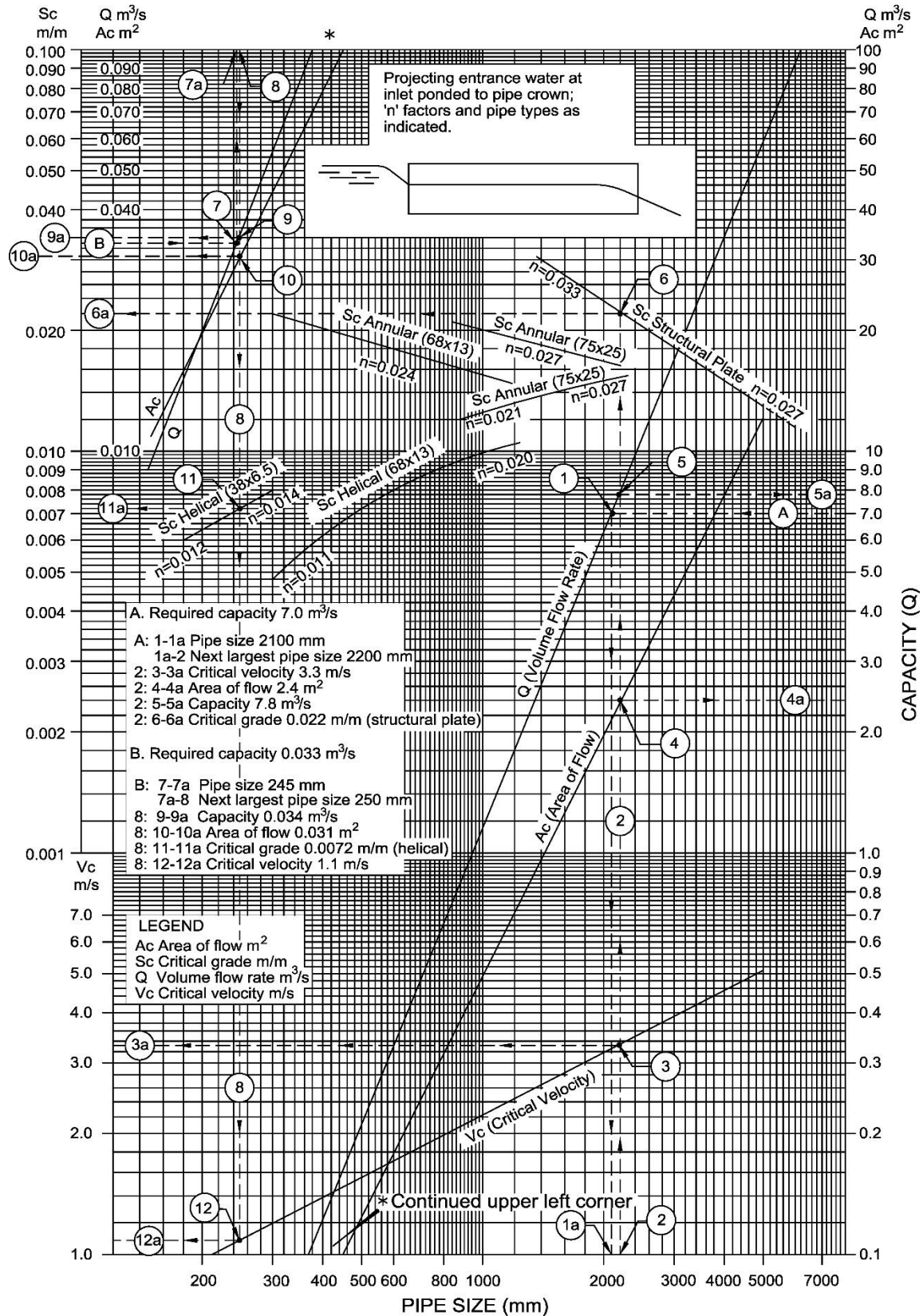

Figure 1040.E Hydraulic Sample Chart for Corrugated Steel Pipe-Arch

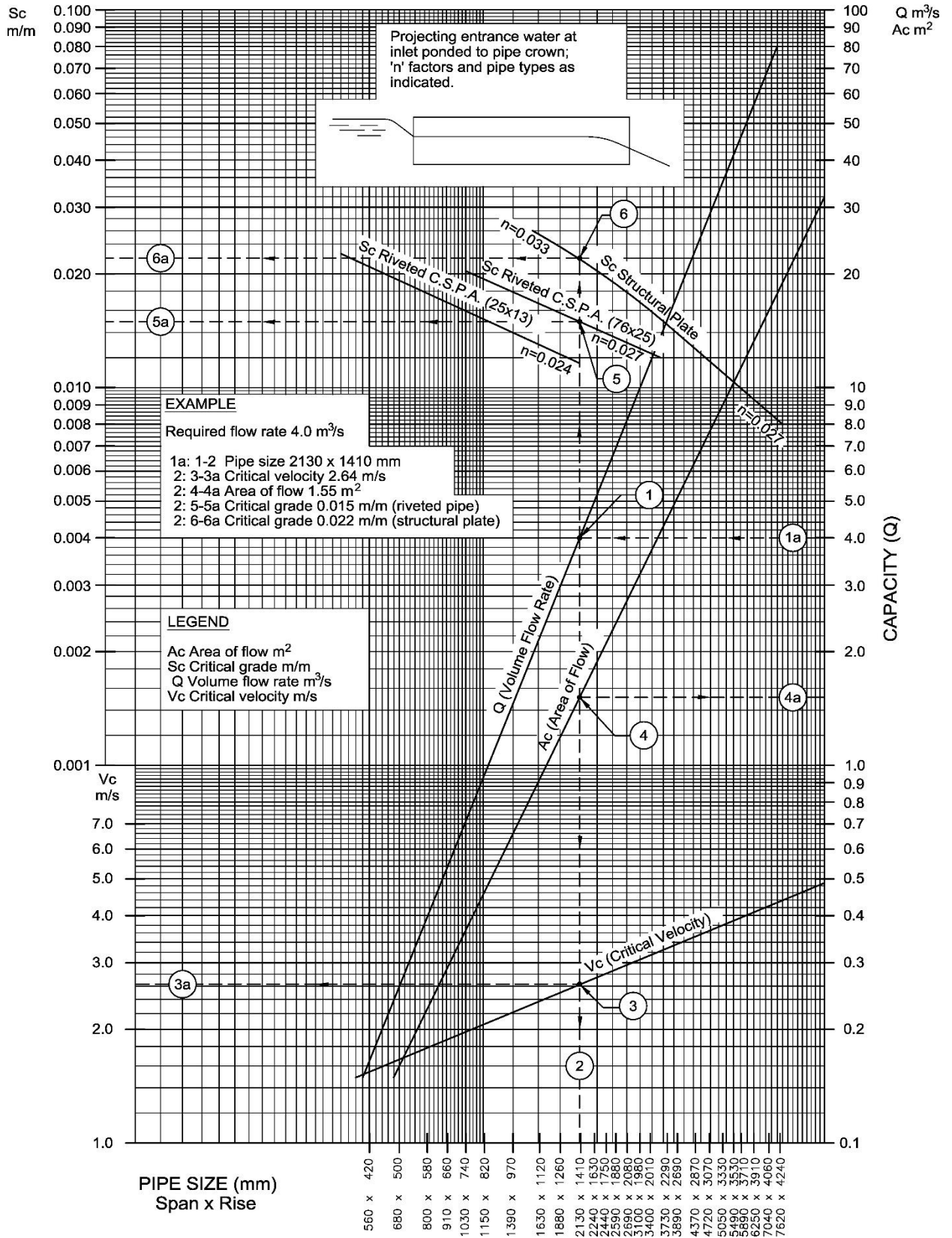
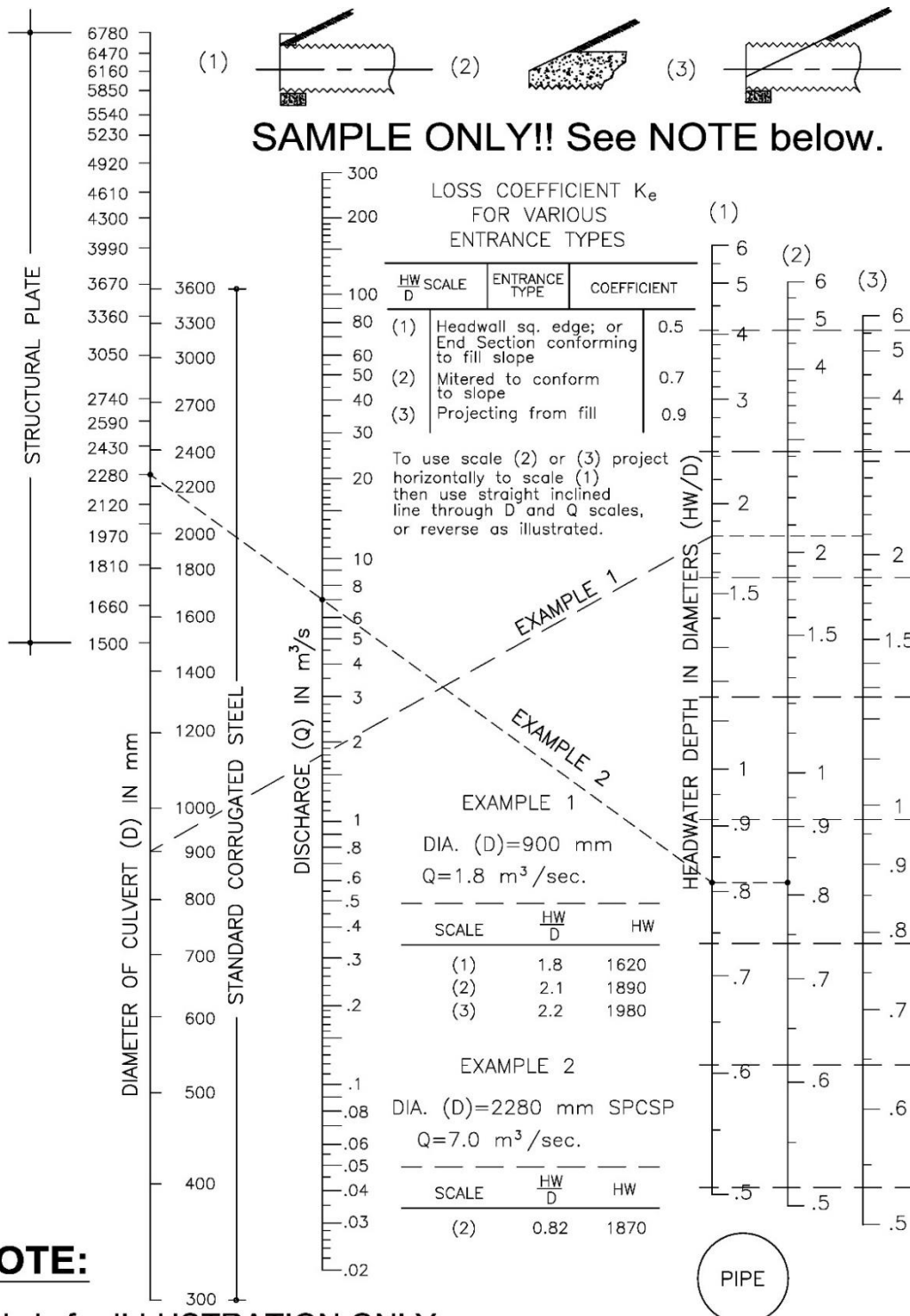

Figure 1040.F Inlet Control Nomograph



**NOTE:**

This is for ILLUSTRATION ONLY.  
Use CSPI Handbook of Steel Drainage & Highway Construction Products (2007), Figure 4.10 on page 151

INLET CONTROL  
HEADWATER DEPTH  
ROUND CSP & SPCSP



MoTI Section	1040	TAC Section	RTAC Drainage Manual Ch.4
--------------	------	-------------	---------------------------

## 1040.04 CULVERT INSTALLATION

Some miscellaneous notes:

- Culvert Installation shall generally conform to the current MoTI Standard Specifications for Highway Construction, Section 303.
- Designate re-corrugated culvert ends with annular couplers for helical CSP culverts where the installation will be on a gradient greater than 15%.
- Annular couplers shall be indicated on the drawings, the additional materials list, and the H741 and H742 forms.

### Foundation Excavation/Base Preparation

Foundation excavations for culverts less than 3000 mm diameter are shown in **Figure 1040.G**. Special conditions apply to SPCSP.

For information on base preparation, refer to:

- ◆ The current MoTI Standard Specifications for Highway Construction, Section 303.

### Backfill/Bedding

For information on backfill or bedding, refer to:

- ◆ The current MoTI Standard Specifications for Highway Construction, Section 303.

### Camber

In situations involving weak foundation soils or high fills, camber should be considered to account for anticipated settlement.

For information on camber, refer to:

- ◆ *CSP Handbook of Steel Drainage and Highway Construction Products (2010)*, p. 314
- ◆ *RTAC Drainage Manual Volume 2 (1982)*, p. 4.14

### End Treatment

Riprap, in combination with geotextile, is generally used for inlet and outlet protection. The average culvert velocity during the design flow should be used to determine riprap requirements. For information on riprap lining and filter blanket, refer to **Section 1030.04**.

To prevent scour around the inlet and outlet, riprap shall be placed in the channel bed and side slopes. The length of the inlet apron should be at least equal to twice the culvert rise while the length of

the outlet apron should be at least equal to four times the culvert rise. The riprap should be placed to a height of at least 0.3 m above the high water level (HWL) or above the crown of the pipe, whichever is higher.

For information and details on concrete inlet and outlet structures, refer to:

- ◆ *RTAC Drainage Manual Volume 2 (1987)*, p. 4.25 and 4.103
- ◆ *CSP Handbook of Steel Drainage and Highway Construction Products (2010)*, p. 300
- ◆ *Specification Dwg. No. SP303-01 to 04 and SP303-08, MoTI Standard Specifications for Highway Construction*

Note: these Standard Specification drawings are for pipes up to 1650 mm diameter only. If inlet or outlet structures are required for larger diameter pipes, they must be designed by a Professional Engineer.

### Headwalls and Wingwalls

A culvert with mitered ends may require headwalls to provide reinforcement by securing the metal edges at the inlet and outlet against earth pressures and hydraulic forces. Headwalls may also be used to counter-weight hydrostatic uplift and prevent end scour.

Wingwalls should be considered for culverts which require end extensions, improved inlet capacity or are in areas with debris or severe scour problems. The purpose of wingwalls is to retain and protect the embankment, and provide a transition between the culvert and the channel. Normally they will consist of flared vertical wingwalls, a full or partial apron and a cutoff wall.

For information on end structures, refer to:

- ◆ *RTAC Drainage Manual Volume 2 (1987)*, p. 4.104

### Cutoff Walls

The inlets of CSP, SWSP, PVC and HDPE culverts are susceptible to hydrostatic lift and may collapse due to this effect. The designer shall assess the potential of undermining and uplift, and incorporate mitigative measures to the design accordingly.

MoTI Section	1040	TAC Section	RTAC Drainage Manual Ch.4
--------------	------	-------------	---------------------------

For information on typical cutoff walls, refer to:

- ◆ *CSPI Handbook of Steel Drainage and Highway Construction Products (2010), Fig. 6.27, p. 300*

### Safety

For culverts larger than 2000 mm and located within the clear zone, the culvert ends can be made safe by the use of suitable grates, but only if the grates do not become a hazard by causing upstream flooding. Culverts in urban environments require grates to prevent human entry. Grates are generally not permitted on culverts which provide fish passage.

Grates are also installed to prevent debris from entering the culvert. For culverts providing fish passage, debris racks rather than grates, should be installed.

At locations where culvert ends cannot be located outside the clear zone and where grates would be

impractical or unsafe, roadside barrier protection should be provided.

For information on safety measures, refer to:

- ◆ *RTAC Drainage Manual Volume 2 (1987), p. 4.15*
- ◆ *TAC Geometric Design Guide (2017), Section 7.4.2*

### Multiple Installations

For multiple pipe installations, one inlet should be lower than the others so that at low to medium flows the water is concentrated in one pipe. This is conducive to fish passage and discourages silting up of the installation.

For multiple pipes and installations refer to:

- ◆ *CSPI Steel Drainage and Highway Construction Products (2010), p. 181, p. 336*

Figure 1040.G Foundation Excavation for Culverts

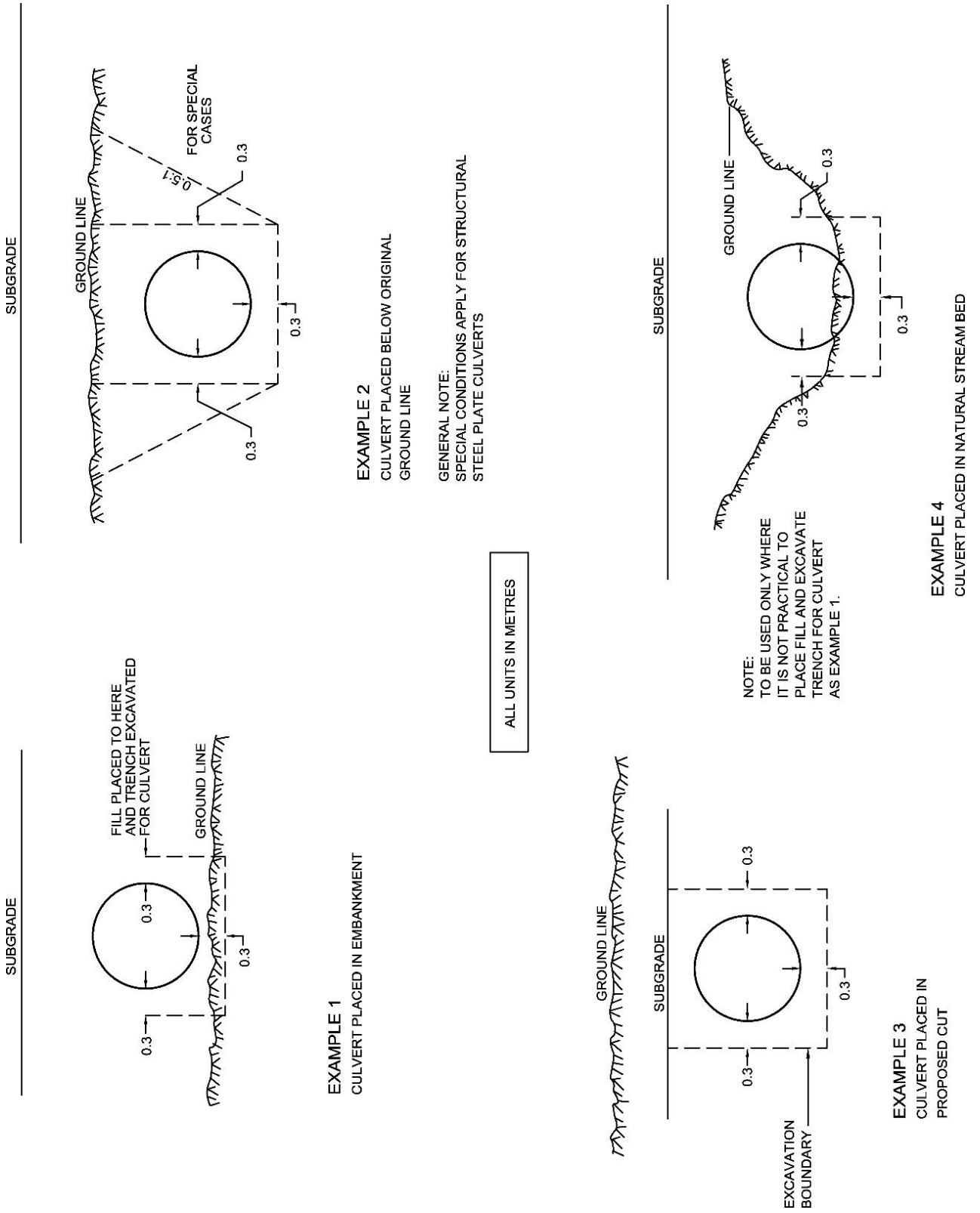

MoTI Section	1040	TAC Section	RTAC Drainage Manual Ch.4
--------------	------	-------------	---------------------------

## 1040.05 CULVERT DESIGN EXAMPLE

### Problem

The design flow ( $Q_{200}$ ) for the creek has been estimated as  $7.0 \text{ m}^3/\text{s}$ . The creek slope at the highway is  $-2.5\%$ . Determine the culvert size and flow characteristics.

### Solution

#### Step 1 - Preliminary Culvert Dimension and Hydraulics

The minimum pipe grade for inlet control and initial dimensions for SPCSP culverts can be determined using **Figure 1040.B**. A worked example (see **Figure 1040.D**) provides the following:

$$Q_{200} = 7.0 \text{ m}^3 / \text{s}$$

$$D = 2200 \text{ mm}$$

$$A_c = 2.4 \text{ m}^2$$

$$Q_{\text{capacity}} = 7.8 \text{ m}^3 / \text{s}$$

$$S_c = 0.022 \text{ m} / \text{m}$$

$$n = 0.031$$

#### Step 2 - Check Headwater Depth

The final culvert slope is  $-2.5\%$ . The slope is steeper than the critical slope ensuring that the culvert will operate under inlet control. If the culvert were to be placed on a milder slope (say  $-1.0\%$ ), outlet control may govern and a backwater analysis would be required to determine the headwater depth.

Referring to **Figure 1040.F** (Example 2), if we assume a  $2.28 \text{ m}$  diameter SPCSP with the entrance mitered to conform to the slope ( $k_e=0.7$ ) and a design flow of  $7.0 \text{ m}^3/\text{s}$ :

$$\frac{HW}{D} = 0.82$$

$$HW = (0.82)(2.28 \text{ m}) = 1.87 \text{ m}$$

The inlet configurations satisfy the inlet control design criteria which requires that the headwater depth to diameter ratio ( $HW/D$ ) not exceed  $1.0$  at the design flow.

#### Step 3 - Determine Full Flow Characteristics

Using Manning's Equation and the Continuity Equation, the full flow characteristics of the culvert can be determined. See Table below

D	A	R=D/4	$R^{0.67}$	n	S	$S^{0.5}/n$	$v_{\text{full}}=R^{0.67}S^{0.5}/n$	$Q_{\text{full}}=vA$
(m)	( $\text{m}^2$ )	(m)			(m/m)		(m/s)	( $\text{m}^3/\text{s}$ )
2.28	4.1	0.57	0.69	0.031	0.025	5.1	3.5	14.4

#### Step 4 - Determine Partial Flow Characteristics

Since the culvert is operating under inlet control, the flow within the barrel will be partially full. Partial flow characteristics for the culvert were determined using a hydraulic element chart for a circular pipe.

$$\frac{Q}{Q_{\text{full}}} = \frac{7.0 \text{ m}^3 / \text{s}}{14.4 \text{ m}^3 / \text{s}} = 0.49$$

$$\frac{d}{D} = 0.5$$

$$d = (0.5)(2.28 \text{ m}) = 1.1 \text{ m}$$

$$\frac{v}{v_{\text{full}}} = 1.0$$

$$v = (1.0)(3.5 \text{ m/s}) = 3.5 \text{ m/s}$$

The average flow velocity in the culvert ( $v$ ) should be used for outlet riprap design, while the average depth of flow ( $d$ ) may be used for outlet control calculations.

MoTI Section	1050	TAC Section	Not Applicable
--------------	------	-------------	----------------

## 1050

# PAVEMENT DRAINAGE AND STORM SEWERS

### 1050.01 RETURN PERIOD

For design return periods, refer to **Section 1010.02**.

### 1050.02 PAVEMENT RUNOFF

The runoff for highway pavements is computed by the Rational Formula Method using a runoff coefficient (C) equal to 0.95 and a minimum time of concentration equal to 5 minutes.

### 1050.03 PAVEMENT GRADES

The desirable minimum sustained grade for curbed pavements is -0.5%, with -0.3% allowed for a curb and gutter section as an absolute minimum. If a level grade on a low-speed curbed road is unavoidable, false grading of the gutter may have to be provided to produce an absolute minimum slope of -0.3% to the inlets. Roadway design should try to limit the number of lanes which drain in one direction.

### 1050.04 PONDING WIDTHS

Gutters should generally be designed such that the maximum ponding width at the catchbasin or spillway is equal to 65% of the paved shoulder width with a minimum of 1.2 m. For low grade roadways, the ponding width may have to be increased to maximize the inlet spacing. However, encroachment of the gutter flow onto the traveled portion is discouraged due to the possibility of hydroplaning, soaking of pedestrians etc. Ponding widths should be measured from the face of the curb.

For information on gutter flow, refer to:

- ◆ *RTAC Drainage Manual Volume 2 (1987), p. 5.22.*

### 1050.05 MEDIANS AND CURBS

Median drainage is generally designed for a maximum depth of 0.3 m.

Drainage curbs and outlets for paved surfaces on erodible slopes will be required if any of the following criteria are met:

- Fill height exceeds 3 m high.
- Longitudinal grade is greater than 4%.
- Superelevation is over 6%.
- Any superelevated pavement is wider than 15 m.

Asphalt curbs are generally used for rural projects. Concrete curbs are used for urban projects and other areas where there is considerable development.

### 1050.06 GRATES/SPILLWAYS

#### Grate Inlets

The current practice is to use Bicycle Safe grates on any roadway which cyclists are permitted to travel. Freeway grates shall be used on all other roadways. Wide pavements tend to require depressed grate inlets. Similarly, urban areas use depressed grate inlets.

Due to vane configurations, twin Bicycle Safe and Freeway grate inlets are recommended in areas where gutter flow velocities exceed 1.5 m/s and 2.0 m/s respectively.

**Table 1050.A** presents grate catchment widths which are recommended for use with the Spreadsheet or Calculator Method grate inlet spacing calculations:

**Table 1050.A - Grate Catchment Widths**

Inlet Type	w (m)
Undepressed Bicycle Safe	0.305
Depressed Bicycle Safe	0.625
Undepressed Freeway	0.375
Depressed Freeway	0.625

For drawings of catchbasin grates, refer to:

- *MoTI Standard Specifications for Highway Construction, Drawing No. SP582-05.01 and 05.02.*

MoTI Section	1050	TAC Section	Not Applicable
--------------	------	-------------	----------------

**Spillways**

In rural areas with potential pavement debris problems (e.g. debris from deciduous or coniferous trees, heavy sanding operations, etc.) spillways may be preferred over catchbasins. The designer shall consult the District operation staff to determine their preference.

Spillway channels lined with riprap are generally recommended. Paved spillway channels are not recommended unless they have very short lengths and adequate soils supporting the sides of the channel. It should also be noted that spillways are more susceptible to damage from snow clearing operations.

**Table 1050.B** presents the spillway catchment width, which is recommended for use with the Spreadsheet/Calculator Method spillway inlet spacing calculations:

**Table 1050.B - Spillway Catchment Width**

Inlet Type	w (m)
Paved Spillway	0.600

**Grates/Spillways Spacing on a Grade**

Research conducted by the Washington State Department of Transportation (WSDOT) has found that the capacity of an inlet on a continuous grade can be estimated by determining the portion of the gutter discharge directly over the width of the inlet. The model assumes a triangular flow cross section and is most accurate for longitudinal slopes of -2% to -3%. The WSDOT model has been modified to account for lateral inflow on mild grades and high velocities on steep grades. Two methods have been developed to provide approximate spacing requirements and also suit calculator and spreadsheet applications.

The inlet spacing calculations should be conducted approximately where the inlet is to be located. At least one iteration will be required to match the assumed inlet location with the calculated inlet location.

For one or two lane roadways, a maximum catchbasin/spillway spacing of 150 m is recommended. The maximum median spacing of

250 m is recommended. The maximum spacing criteria has been established to facilitate maintenance operations and to prevent an excessively long flow path in the event that one becomes blocked. For one and two lane roadways, a minimum catchbasin/spillway spacing of 20 m is recommended. The minimum spacing criteria has been established to prevent over-conservative designs.

**Tabular Method**

The Tabular Method provides a quick estimate of the inlet spacings, but is limited in terms of crossfall and longitudinal grade combinations. The tables were developed using a runoff coefficient (C) equal to 0.95 and a ponding width of 1.2 m. The tables are useful for normal crossfall and longitudinal grades between 2% and 4%.

Inlet spacing coefficients have been provide in **Table 1050.D**, **Table 1050.E** and **Table 1050.F** for depressed Bicycle Safe grates, depressed Freeway grates and undepressed Bicycle Safe grates. The notation for the spacing tables are as follows:

- $s_y$  is the longitudinal grade, m/m
- $s_x$  is the crossfall, m/m
- $i$  is the rainfall intensity for  $t_c$  equal to 5 minutes, 5 year return period, mm/hr
- $C_1, C_2$  is the spacing coefficients for a single grate
- $C1, C2$  is the spacing coefficients for twin grates
- $CB_{one}$  is the initial inlet spacing, m
- $CB_{two}$  is the consecutive inlet spacing, m

The following procedure shall be used to estimate catchbasin spacings:

1. Select appropriate rainfall intensity.
2. Select the longitudinal grade ( $s_y$ ) and crossfall ( $s_x$ ) which closely matches the assumed inlet location. It may be necessary to try more than one location.
3. From the appropriate table, select appropriate values for  $C_1, C_2$  (single) or  $C1, C2$  (twin).
4. Determine effective/average pavement width (w) from drainage patterns.

MoTI Section	1050	TAC Section	Not Applicable
--------------	------	-------------	----------------

5. For single grates, determine  $CB_{one}$  and  $CB_{two}$  using pavement width ( $w$ ) in the following formulas:

$$CB_{one} = \frac{C1}{w} \quad CB_{two} = \frac{C2}{w}$$

else, for twin grates, determine  $CB_{one}$  and  $CB_{two}$  using pavement width in the following formulas:

$$CB_{one} = \frac{1.2C1}{w} \quad CB_{two} = \frac{1.2C2}{w}$$

**Table 1050.C Inlet Capacities**

	Maximum Intercept (m <sup>3</sup> /s)	
	On Grade	At Low Point
Single CB	0.0127	0.0283
Double CB	0.0210	0.0566
Spillway	0.0283	

(from H763GR form)

**Table 1050.D Inlet Spacing Tables for Depressed BC Bicycle Safe Grate**

i (mm/h)	Sx=0.02 Sy=0.003		Sx=0.02 Sy=0.005		Sx=0.02 Sy=0.010		Sx=0.02 Sy=0.015		Sx=0.02 Sy=0.02		Sx=0.02 Sy=0.04	
	C1 (m <sup>2</sup> )	C2 (m <sup>2</sup> )	C1 (m <sup>2</sup> )	C2 (m <sup>2</sup> )	C1 (m <sup>2</sup> )	C2 (m <sup>2</sup> )	C1 (m <sup>2</sup> )	C2 (m <sup>2</sup> )	C1 (m <sup>2</sup> )	C2 (m <sup>2</sup> )	C1 (m <sup>2</sup> )	C2 (m <sup>2</sup> )
20	455	436	587	531	834	758	1023	928	1194	1061	1686	1516
30	303	291	392	354	556	505	682	619	796	707	1124	1011
40	227	218	294	265	417	379	512	464	597	531	843	758
50	182	174	235	212	333	303	409	371	477	424	675	606
60	152	145	196	177	278	253	341	309	398	354	562	505
70	130	125	168	152	238	217	292	265	341	303	482	433
80	114	109	147	133	208	189	256	232	298	265	422	379
90	101	97	131	118	185	168	227	206	265	236	375	337
100	91	87	117	106	167	152	205	186	239	212	337	303
110	83	79	107	96	152	138	186	169	217	193	307	276

i (mm/h)	Sx=0.04 Sy=0.003		Sx=0.04 Sy=0.005		Sx=0.04 Sy=0.010		Sx=0.04 Sy=0.015		Sx=0.04 Sy=0.02		Sx=0.04 Sy=0.04	
	C1 (m <sup>2</sup> )	C2 (m <sup>2</sup> )	C1 (m <sup>2</sup> )	C2 (m <sup>2</sup> )	C1 (m <sup>2</sup> )	C2 (m <sup>2</sup> )	C1 (m <sup>2</sup> )	C2 (m <sup>2</sup> )	C1 (m <sup>2</sup> )	C2 (m <sup>2</sup> )	C1 (m <sup>2</sup> )	C2 (m <sup>2</sup> )
20	1459	1402	1895	1762	2672	2406	3278	2937	3789	3392	5343	4794
30	973	935	1263	1175	1781	1604	2185	1958	2526	2261	3562	3196
40	729	701	947	881	1336	1203	1639	1468	1895	1696	2672	2397
50	584	561	758	705	1069	963	1311	1175	1516	1357	2137	1917
60	486	467	632	587	891	802	1093	979	1263	1131	1781	1598
70	417	401	541	503	763	688	937	839	1083	969	1527	1370
80	365	351	474	441	668	602	819	734	947	848	1336	1198
90	324	312	421	392	594	535	728	653	842	754	1187	1065
100	292	280	379	352	534	481	656	587	758	678	1069	959
110	265	255	344	320	486	438	596	534	689	617	971	872

MoTI Section	1050	TAC Section	Not Applicable
--------------	------	-------------	----------------

Table 1050.E Inlet Spacing Tables for Depressed BC Freeway Grate

	<b>Sx=0.02</b>		<b>Sx=0.02</b>		<b>Sx=0.02</b>		<b>Sx=0.02</b>		<b>Sx=0.02</b>		<b>Sx=0.02</b>	
	<b>Sy=0.003</b>		<b>Sy=0.005</b>		<b>Sy=0.010</b>		<b>Sy=0.015</b>		<b>Sy=0.02</b>		<b>Sy=0.04</b>	
<b>i</b> <b>(mm/h)</b>	<b>C1</b> <b>(m<sup>2</sup>)</b>	<b>C2</b> <b>(m<sup>2</sup>)</b>	<b>C1</b> <b>(m<sup>2</sup>)</b>	<b>C2</b> <b>(m<sup>2</sup>)</b>	<b>C1</b> <b>(m<sup>2</sup>)</b>	<b>C2</b> <b>(m<sup>2</sup>)</b>	<b>C1</b> <b>(m<sup>2</sup>)</b>	<b>C2</b> <b>(m<sup>2</sup>)</b>	<b>C1</b> <b>(m<sup>2</sup>)</b>	<b>C2</b> <b>(m<sup>2</sup>)</b>	<b>C1</b> <b>(m<sup>2</sup>)</b>	<b>C2</b> <b>(m<sup>2</sup>)</b>
20	455	436	587	531	834	758	1023	928	1194	1061	1686	1516
30	303	291	392	354	556	505	682	619	796	707	1124	1011
40	227	218	294	265	417	379	512	464	597	531	843	758
50	182	174	235	212	333	303	409	371	477	424	675	606
60	152	145	196	177	278	253	341	309	398	354	562	505
70	130	125	168	152	238	217	292	265	341	303	482	433
80	114	109	147	133	208	189	256	232	298	265	422	379
90	101	97	131	118	185	168	227	206	265	236	375	337
100	91	87	117	106	167	152	205	186	239	212	337	303
110	83	79	107	96	152	138	186	169	217	193	307	276
	<b>Sx=0.04</b>		<b>Sx=0.04</b>		<b>Sx=0.04</b>		<b>Sx=0.04</b>		<b>Sx=0.04</b>		<b>Sx=0.04</b>	
	<b>Sy=0.003</b>		<b>Sy=0.005</b>		<b>Sy=0.010</b>		<b>Sy=0.015</b>		<b>Sy=0.02</b>		<b>Sy=0.04</b>	
<b>i</b> <b>(mm/h)</b>	<b>C1</b> <b>(m<sup>2</sup>)</b>	<b>C2</b> <b>(m<sup>2</sup>)</b>	<b>C1</b> <b>(m<sup>2</sup>)</b>	<b>C2</b> <b>(m<sup>2</sup>)</b>	<b>C1</b> <b>(m<sup>2</sup>)</b>	<b>C2</b> <b>(m<sup>2</sup>)</b>	<b>C1</b> <b>(m<sup>2</sup>)</b>	<b>C2</b> <b>(m<sup>2</sup>)</b>	<b>C1</b> <b>(m<sup>2</sup>)</b>	<b>C2</b> <b>(m<sup>2</sup>)</b>	<b>C1</b> <b>(m<sup>2</sup>)</b>	<b>C2</b> <b>(m<sup>2</sup>)</b>
20	1459	1402	1895	1762	2672	2406	3278	2937	3789	3392	5343	4794
30	973	935	1263	1175	1781	1604	2185	1958	2526	2261	3562	3196
40	729	701	947	881	1336	1203	1639	1468	1895	1696	2672	2397
50	584	561	758	705	1069	963	1311	1175	1516	1357	2137	1917
60	486	467	632	587	891	802	1093	979	1263	1131	1781	1598
70	417	401	541	503	763	688	937	839	1083	969	1527	1370
80	365	351	474	441	668	602	819	734	947	848	1336	1198
90	324	312	421	392	594	535	728	653	842	754	1187	1065
100	292	280	379	352	534	481	656	587	758	678	1069	959
110	265	255	344	320	486	438	596	534	689	617	971	872



MoTI Section	1050	TAC Section	Not Applicable
--------------	------	-------------	----------------

Table 1050.F Inlet Spacing Tables for Undepressed BC Bicycle Safe Grate

	<b>Sx=0.02</b>		<b>Sx=0.02</b>		<b>Sx=0.02</b>		<b>Sx=0.02</b>		<b>Sx=0.02</b>		<b>Sx=0.02</b>	
	<b>Sy=0.003</b>		<b>Sy=0.005</b>		<b>Sy=0.010</b>		<b>Sy=0.015</b>		<b>Sy=0.02</b>		<b>Sy=0.04</b>	
<i>i</i> (mm/h)	C1 (m <sup>2</sup> )	C2 (m <sup>2</sup> )	C1 (m <sup>2</sup> )	C2 (m <sup>2</sup> )	C1 (m <sup>2</sup> )	C2 (m <sup>2</sup> )	C1 (m <sup>2</sup> )	C2 (m <sup>2</sup> )	C1 (m <sup>2</sup> )	C2 (m <sup>2</sup> )	C1 (m <sup>2</sup> )	C2 (m <sup>2</sup> )
20	455	284	587	341	834	493	1023	606	1194	644	1686	909
30	303	189	392	227	556	328	682	404	796	429	1124	606
40	227	142	294	171	417	246	512	303	597	322	843	455
50	182	114	235	136	333	197	409	243	477	258	675	364
60	152	95	196	114	278	164	341	202	398	215	562	303
70	130	81	168	97	238	141	292	173	341	184	482	260
80	114	71	147	85	208	123	256	152	298	161	422	227
90	101	63	131	76	185	109	227	135	265	143	375	202
100	91	57	117	68	167	99	205	121	239	129	337	182
110	83	52	107	62	152	90	186	110	217	117	307	165
	<b>Sx=0.04</b>		<b>Sx=0.04</b>		<b>Sx=0.04</b>		<b>Sx=0.04</b>		<b>Sx=0.04</b>		<b>Sx=0.04</b>	
	<b>Sy=0.003</b>		<b>Sy=0.005</b>		<b>Sy=0.010</b>		<b>Sy=0.015</b>		<b>Sy=0.02</b>		<b>Sy=0.04</b>	
<i>i</i> (mm/h)	C1 (m <sup>2</sup> )	C2 (m <sup>2</sup> )	C1 (m <sup>2</sup> )	C2 (m <sup>2</sup> )	C1 (m <sup>2</sup> )	C2 (m <sup>2</sup> )	C1 (m <sup>2</sup> )	C2 (m <sup>2</sup> )	C1 (m <sup>2</sup> )	C2 (m <sup>2</sup> )	C1 (m <sup>2</sup> )	C2 (m <sup>2</sup> )
20	1459	966	1895	1175	2672	1554	3278	1914	3789	2046	5343	2899
30	973	644	1263	783	1781	1036	2185	1276	2526	1364	3562	1933
40	729	483	947	587	1336	777	1639	957	1895	1023	2672	1449
50	584	387	758	470	1069	621	1311	765	1516	819	2137	1160
60	486	322	632	392	891	518	1093	638	1263	682	1781	966
70	417	276	541	336	763	444	937	547	1083	585	1527	828
80	365	242	474	294	668	388	819	478	947	512	1336	725
90	324	215	421	261	594	345	728	425	842	455	1187	644
100	292	193	379	235	534	311	656	383	758	409	1069	580
110	265	176	344	214	486	282	596	348	689	372	971	527

MoTI Section	1050	TAC Section	Not Applicable
--------------	------	-------------	----------------

**Spreadsheet/Calculator Method**

The Spreadsheet/Calculator Method provides a detailed estimate of the inlet spacings for different crossfall and longitudinal grade combinations. This method is useful for low grades when using varying design ponding widths and optimizing inlet spacings.

The model requires the following design input:

- SW is the paved shoulder width, m
- $y_0$  is the design depth of flow (for median), m
- $S_y$  is the longitudinal grade, m/m
- $S_x$  is the crossfall, m/m
- $n$  is the Manning’s roughness coefficient
- $i$  is the rainfall intensity for  $t_c$  equal to 5 minutes, 5 year return period, mm/hr
- width is the effective width of contributing area, m
- $C_w$  is the width weighted runoff coefficient
- $w$  is the inlet catchment width, m

The model will calculate the following values:

- PW is the design ponding width, m
- $y_0$  is the maximum depth of gutter flow (for pavement), m
- $R_s$  is the crossfall-longitudinal grade ratio, m
- $w_{eff}$  is the effective inlet catchment width, m
- $v$  is the gutter flow velocity, m/s
- $Q_0$  is the gutter flow,  $m^3/s$
- $y_{over}$  is the maximum depth of flow outside the catchment width, m
- $Q_{over}$  is the overflow,  $m^3/s$
- $Q_{int}$  is the intercepted flow,  $m^3/s$
- Eff is the inlet efficiency, %
- $CB_{one}$  is the initial inlet spacing, m
- $CB_{two}$  is the consecutive inlet spacing, m

For detailed Spreadsheet/Calculator Method calculations, refer to **Figures 1050.G to I.**

**Grates/Spillways in a Sag Vertical Curve**

Twin catchbasins or a spillway should be placed in a sag vertical curve to maximize the open area. To prevent excess ponding, the distance to the next inlet should not exceed 100 m.

Quite often in a vertical sag situation on higher fills, two separate drainage inlets are placed in close proximity to each other. The intent of this measure is to provide additional drainage capacity in the event that if one of the inlets becomes plugged, slope failure will not occur.

**Grates/Spillways on a Crest Vertical Curve**

On vertical curves, the longitudinal grades near the crest are gradually reduced to zero and will result in closely spaced inlets. To increase the drainage capacity of the gutter, it might be possible to increase the crossfall (typically from 2% to 3%) at the crest. The crossfall transition should be long enough and far enough from the crest so as not to adversely affect the longitudinal slope of the gutter.

**Cross-Over Flow**

Particular attention should be paid to situations where rapid changes in grade and crossfall occur.

Sag vertical curve and spiral combinations may experience channelized gutter flow which can leave one side of the pavement and cross-over to the other side. Careful attention must be paid to inlet spacings within the runout zone to minimize the bypass or cross-over flow. Since the inlet spacing methodologies presented in Section 1050.06 assume a certain degree of bypass flow, it is recommended that the last two inlets upslope of the Tangent to Spiral point should only be half the distance given by the design methodologies.

Crest vertical curve and spiral combinations generally will not experience this type of channelized cross-over flow.

**Bridge Approaches**

The drainage for bridge decks is usually designed to only accommodate the bridge surface with no allowance for runoff from the approach roads. To avoid flow onto the bridge deck, the spacing of the last two catchbasins upslope of the bridge should only be half the distance given by the design methodologies. The last catchbasin should be as near to the end of the bridge as practicable.

MoTI Section	1050	TAC Section	Not Applicable
--------------	------	-------------	----------------

Figure 1050.G Sample Spreadsheet - Spacing for Depressed/Undepressed BC Bicycle Safe Grate

Design Input				
SW	= paved shoulder width	=	1.2 m	<input>
s <sub>y</sub>	= longitudinal grade	=	0.03 m/m	<input>
s <sub>x</sub>	= crossfall	=	0.02 m/m	<input>
n	= Manning's roughness coefficient	=	0.020	<input>
i	= rainfall intensity corresponding to t <sub>c</sub> equal to 5 minutes, 5 year return period	=	30 mm/hr	<input>
width	= effective width of contributing area	=	10 m	<input>
C <sub>w</sub>	= width weighted runoff coefficient	=	0.95	<input>
w	= inlet catchment width	=	0.625 m	<input>
Note:	w=0.305 m for undepressed B.C. Bicycle Safe grate. w=0.625 m for depressed B.C. Bicycle Safe grate.			
Calculate gutter flow and catchbasin spacing				
PW	= if(SW < 1.85, 1.2, SW * 0.65)	=	1.2 m	<calc>
y <sub>0</sub>	= PW * s <sub>x</sub>	=	0.024 m	<calc>
R <sub>s</sub>	= s <sub>x</sub> /s <sub>y</sub>	=	0.67	<calc>
w <sub>eff</sub>	= if(R <sub>s</sub> < 5.1, 1.1 * w, if(R <sub>s</sub> < 10.1, 1.2 * w, if(R <sub>s</sub> < 15.1, 1.3 * w, if(R <sub>s</sub> < 20.1, 1.4 * w, 1.5 * w)))	=	0.688 m	<calc>
v	= y <sub>0</sub> ^0.67 * s <sub>y</sub> ^0.5 / n	=	0.71 m/s	<calc>
Q <sub>0</sub>	= 0.375 * s <sub>y</sub> ^0.5 * y <sub>0</sub> ^2.67 / (n * s <sub>x</sub> )	=	0.0077 m <sup>3</sup> /s	<calc>
y <sub>over</sub>	= (PW - w <sub>eff</sub> ) * s <sub>x</sub>	=	0.010 m	<calc>
Q <sub>over</sub>	= 0.375 * s <sub>y</sub> ^0.5 * y <sub>over</sub> ^2.67 / (n * s <sub>x</sub> )	=	0.0008 m <sup>3</sup> /s	<calc>
Q <sub>int</sub>	= if(v < 1.5, Q <sub>0</sub> - Q <sub>over</sub> , if(v < 2, Q <sub>0</sub> - 1.1 * Q <sub>over</sub> , if(v < 2.5, Q <sub>0</sub> - 1.2 * Q <sub>over</sub> , Q <sub>0</sub> - 1.3 * Q <sub>over</sub> )))	=	0.0069 m <sup>3</sup> /s	<calc>
Eff	= Q <sub>int</sub> /Q <sub>0</sub> * 100	=	89.7 %	<calc>
CB <sub>one</sub>	= if(V < 1.5, Q <sub>0</sub> / (C <sub>w</sub> * i * width / (360 * 10000)), 1.2 * Q <sub>0</sub> / (C <sub>w</sub> * i * width / (360 * 10000)))	=	97.1 m	<calc>
CB <sub>two</sub>	= if(V < 1.5, Q <sub>int</sub> / (C <sub>w</sub> * i * width / (360 * 10000)), 1.2 * Q <sub>int</sub> / (C <sub>w</sub> * i * width / (360 * 10000)))	=	87.1 m	<calc>
Results				
Gutter velocity is less than 1.5 m/s - single inlet required.				
Initial catchbasin spacing is approximately 97 m				
Consecutive catchbasin spacing is approximately 87 m				

Text shown in Column 4 of this section are the actual formulae for those who wish to create a similar spreadsheet.

Results output should incorporate tests for velocity to determine if single or double inlet is required, as well as minimum and maximum length test for initial and consecutive catchbasin spacings.

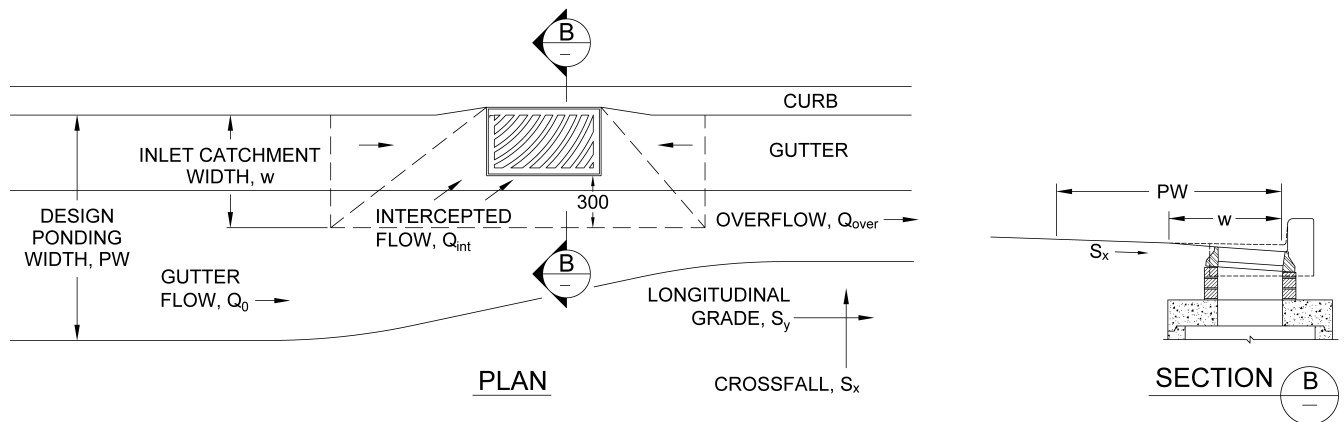

GRAPHICAL DEFINITION OF SYMBOLS

MoTI Section	1050	TAC Section	Not Applicable
--------------	------	-------------	----------------

Figure 1050.H Sample Spreadsheet - Spacing for Depressed/Undepressed BC Freeway Grate

<b>Design Input</b>				
SW	= paved shoulder width	=	1.85 m	<input>
s <sub>y</sub>	= longitudinal grade	=	0.003 m/m	<input>
s <sub>x</sub>	= cross fall	=	0.02 m/m	<input>
n	= Manning's roughness coefficient	=	0.020	<input>
i	= rainfall intensity corresponding to t <sub>c</sub> equal to 5 minute, 5 year return period	=	35 mm/hr	<input>
width	= effective width of contributing area	=	10 m	<input>
C <sub>w</sub>	= width weighted runoff coefficient	=	0.95	<input>
w	= inlet catchment width	=	0.625 m	<input>
Note:	w=0.375 m for undepressed B.C. Freeway grate. w=0.625 m for depressed B.C. Freeway grate.			
<b>Calculate gutter flow and catchbasin spacing</b>				
PW	= if(SW<1.85,1.2,SW*0.65)	=	1.2 m	<calc>
y <sub>0</sub>	= PW*s <sub>x</sub>	=	0.024 m	<calc>
R <sub>s</sub>	= s <sub>x</sub> /s <sub>y</sub>	=	6.67	<calc>
w <sub>eff</sub>	= if(R <sub>s</sub> <5.1,1.1*w,if(R <sub>s</sub> <10.1,1.2*w,if(R <sub>s</sub> <15.1,1.3*w,if(R <sub>s</sub> <20.1,1.4*w,1.5*w))))	=	0.750 m	<calc>
v	= y <sub>0</sub> <sup>0.67</sup> *s <sub>y</sub> <sup>0.5</sup> /n	=	0.23 m/s	<calc>
Q <sub>0</sub>	= 0.375*s <sub>y</sub> <sup>0.5</sup> *y <sub>0</sub> <sup>2.67</sup> /(n*s <sub>x</sub> )	=	0.0024 m <sup>3</sup> /s	<calc>
y <sub>over</sub>	= (PW-w <sub>eff</sub> )*s <sub>x</sub>	=	0.009 m	<calc>
Q <sub>over</sub>	= 0.375*s <sub>y</sub> <sup>0.5</sup> *y <sub>over</sub> <sup>2.67</sup> /(n*s <sub>x</sub> )	=	0.0002 m <sup>3</sup> /s	<calc>
Q <sub>int</sub>	= if(v<2,Q <sub>0</sub> -Q <sub>over</sub> ,if(v<2.5,Q <sub>0</sub> -1.1*Q <sub>over</sub> ,if(v<3,Q <sub>0</sub> -1.2*Q <sub>over</sub> ,Q <sub>0</sub> -1.3*Q <sub>over</sub> )))	=	0.0023 m <sup>3</sup> /s	<calc>
Eff	= Q <sub>int</sub> /Q <sub>0</sub> *100	=	92.6 %	<calc>
CB <sub>one</sub>	= if(v<2,Q <sub>0</sub> /(C <sub>w</sub> *i*width/(360*10000)), 1.2*Q <sub>0</sub> /(C <sub>w</sub> *i*width/(360*10000)))	=	26.5 m	<calc>
CB <sub>two</sub>	= if(v<2,Q <sub>int</sub> /(C <sub>w</sub> *i*width/(360*10000)), 1.2*Q <sub>int</sub> /(C <sub>w</sub> *i*width/(360*10000)))	=	24.5 m	<calc>
<b>Results</b>				
	Gutter velocity is less than 2 m/s - single inlet required.			
	Initial catchbasin spacing is approximately 26 m			
	Consecutive catchbasin spacing is approximately 25 m			

MoTI Section	1050	TAC Section	Not Applicable
--------------	------	-------------	----------------

Figure 1050.I Sample Spreadsheet - Inlet Spacing for Spillways

Design Input				
SW	= paved shoulder width	=	1.85 m	<input>
s <sub>y</sub>	= longitudinal grade	=	0.005 m/m	<input>
s <sub>x</sub>	= crossfall	=	0.02 m/m	<input>
n	= Manning's roughness coefficient	=	0.020	<input>
i	= rainfall intensity corresponding to t <sub>c</sub> equal to 5 minute, 5 year return period	=	35 mm/hr	<input>
width	= effective width of contributing area	=	10 m	<input>
C <sub>w</sub>	= width weighted runoff coefficient	=	0.95	<input>
w	= grate catchment width	=	0.600 m	<input>
Note:	w=0.600 m for paved spillway			
Calculate gutter flow and catchbasin spacing				
PW	= if(SW < 1.85, 1.2, SW * 0.65)	=	1.2 m	<calc>
y <sub>0</sub>	= PW * s <sub>x</sub>	=	0.024 m	<calc>
R <sub>s</sub>	= s <sub>x</sub> /s <sub>y</sub>	=	4.00	<calc>
w <sub>eff</sub>	= if(R <sub>s</sub> < 5.1, 1.1 * w, if(R <sub>s</sub> < 10.1, 1.2 * w, if(R <sub>s</sub> < 15.1, 1.3 * w, if(R <sub>s</sub> < 20.1, 1.4 * w, 1.5 * w)))	=	0.660 m	<calc>
v	= y <sub>0</sub> <sup>0.67</sup> * s <sub>y</sub> <sup>0.5</sup> / n	=	0.29 m/s	<calc>
Q <sub>0</sub>	= 0.375 * s <sub>y</sub> <sup>0.5</sup> * y <sub>0</sub> <sup>2.67</sup> / (n * s <sub>x</sub> )	=	0.0032 m <sup>3</sup> /s	<calc>
y <sub>over</sub>	= (PW - w <sub>eff</sub> ) * s <sub>x</sub>	=	0.011 m	<calc>
Q <sub>over</sub>	= 0.375 * s <sub>y</sub> <sup>0.5</sup> * y <sub>over</sub> <sup>2.67</sup> / (n * s <sub>x</sub> )	=	0.0004 m <sup>3</sup> /s	<calc>
Q <sub>int</sub>	= if(v < 2, Q <sub>0</sub> - Q <sub>over</sub> , if(v < 2.5, Q <sub>0</sub> - 1.1 * Q <sub>over</sub> , if(v < 3, Q <sub>0</sub> - 1.2 * Q <sub>over</sub> , Q <sub>0</sub> - 1.3 * Q <sub>over</sub> )))	=	0.0028 m <sup>3</sup> /s	<calc>
Eff	= Q <sub>int</sub> / Q <sub>0</sub> * 100	=	88.1 %	<calc>
CB <sub>one</sub>	= if(V < 2, Q <sub>0</sub> / (C <sub>w</sub> * i * width / (360 * 10000)), 1.2 * Q <sub>0</sub> / (C <sub>w</sub> * i * width / (360 * 10000)))	=	34.2 m	<calc>
CB <sub>two</sub>	= if(V < 2, Q <sub>int</sub> / (C <sub>w</sub> * i * width / (360 * 10000)), 1.2 * Q <sub>int</sub> / (C <sub>w</sub> * i * width / (360 * 10000)))	=	30.1 m	<calc>
Results				
	Initial spillway spacing is approximately 34 m			
	Consecutive spillway spacing is approximately 30 m			

MoTI Section	1050	TAC Section	Not Applicable
--------------	------	-------------	----------------

## 1050.07 CATCHBASINS

### Catchbasin Locations

In general, inlets should be placed at all low points in the gutter grade and at intersections to prevent the gutter flow from crossing traffic lanes of the intersecting road. In urban locations, inlets are normally placed up grade from the pedestrian crossings to intercept the gutter flow before it reaches the cross walk.

Catchbasin locations should be determined in conjunction with values derived in Section 1050.06.

For information on catchbasin locations, refer to:

- ◆ *RTAC Drainage Manual Volume 2 (1987), p. 5.40.*
- ◆ *TAC Geometric Design Guide (2017), Section 4.8.*

### Concrete and Cast Iron Catchbasin

Cast iron catchbasins are used in conjunction with asphalt drainage curbs to provide shoulder drainage.

Concrete catchbasins are used to provide shoulder drainage as well as act as a junction between pipe sections.

Trapping hoods are required in concrete catchbasins to prevent debris and sediment from entering the pipe system. This is particularly important for small diameter pipes on flat grades where sediment can accumulate along the invert or on pipes with steep grades where invert abrasion can occur.

### Catchbasin Lead Pipe

Minimum 200 mm diameter lead pipe is recommended for catchbasin and median drainage to prevent blockage. Lead pipe design should consider catchbasin flow capacities.

Minimum -0.5% slope is recommended for a catchbasin lead installation.

## 1050.08 STORM SEWERS

### General

Storm sewer systems associated with MoTI projects are usually designed to pick up flow from catchbasins along a new highway or rehabilitated urban streets. These pipe systems are limited in extent and generally require relatively simple methods of analysis. The Rational Method is recommended for calculating the flow quantities for these systems and simple equations and charts can be used to estimate pipe sizes and flow times in the sewers. A simple design example is provided in Example 5.4. For complicated systems where the sewer network may serve a considerable area, more complicated methods of analysis may be required.

For information on more advanced calculation methods, refer to:

- ◆ *RTAC Drainage Manual Volume 2 (1987), p. 5.51.*
- ◆ *CSPI Modern Sewer Design (1996), p. 125.*

### Design Return Periods

For design storm return periods, refer to Section 1010.02.

The storm sewer system design should be based on the minor/major concept whereby the minor sewer pipe system is designed to carry up to the 10 to 25 year return period storm. Flows in excess of the pipe system capacity are assumed to flow overland to the natural drainage system for the area. With this concept, it is important that in conjunction with designing the pipe system the flow routes for the major floods are also examined and designed where necessary.

In instances where there is no possibility of overland routes for the major flows, some sections of the pipe system may have to be designed for the major flows.

### Location

Medians usually offer the most desirable storm sewer locations. In the absence of medians, a location beyond the edge of pavement within the right of way or drainage easement is preferable. It is generally recommended when a storm sewer is

MoTI Section	1050	TAC Section	Not Applicable
--------------	------	-------------	----------------

placed beyond the edge of pavement that one system, with connecting laterals, be used instead of two systems, with one running down each side. If a storm sewer must be located under the pavement, sufficient vertical clearance must be provided for making the proper inlet to storm sewer connections.

### Manholes

Manholes should be located at all changes in direction, grade, pipe size, flow rate and invert elevation to minimize hydraulic and maintenance difficulties. Manholes should also be located such that they do not interfere with the vehicle wheel path.

The following maximum manhole spacings are recommended:

**Table 1050.J Manhole Spacings**

Pipe Diameter (mm)	Spacing (m)
< 250	Maximum 100
250-400	Maximum 120
500-900	Maximum 200
> 900	Maximum 250

The crown of pipes at manholes must be at the same elevation. During the design procedure, it may be critical to recognize the minor losses at junctions. Possible situations of concern include: changes in pipe diameter and abrupt changes in alignment and slope.

Pipe runs should generally be straight between manholes. The pipes may be laid in curves, either horizontal or vertical, but only one curve is allowable between manholes. The pipe curvature should be as per pipe manufacturer's specification but in no case can the radius be less than 35 m.

Manhole heights may require adjustment to provide positive drainage.

For information on manholes, refer to:

- ◆ *RTAC Drainage Manual Volume 2 (1987), p. 5.85.*

For information on manhole sizes, refer to:

- ◆ *MoTI Standard Specifications for Highway Construction, Drawing SP582-03.01.*

### Velocities

Velocities should be 0.6 m/s and greater to prevent silting and clogging the pipes. This velocity should be calculated under full flow condition even if the pipe is only flowing partially full with the design storm. With water carrying highly abrasive material over relatively long periods, velocities should be limited to say 5 m/s. In some areas it may be necessary to lay the pipes at flatter gradients than the ground surface in order to meet maximum velocity criteria in which drop manholes may be required.

### Pipes on a Grade

In cases where the roadway or ground profile grades increase downstream along a storm sewer, a smaller diameter pipe may sometimes be sufficient to carry the flow at the steeper grade. However, since decreasing the pipe diameter downstream is not recommended, these pipes end up being oversized.

Consideration should be given in such cases to the possibility of running the entire length of pipe at a grade steep enough to minimize the need to use a larger diameter pipe. Although this will necessitate deeper trenches, it is possible for the savings in pipe costs to exceed the increased cost in excavation.

Where storm sewers are laid on steep terrain there may be considerable savings to be made by laying the pipe parallel to the ground surface rather than using drop manholes. The high velocities are not suitable for water with heavy sediment loads, which could abrade the pipe, but may be appropriate where the flows are relatively clean and intermittent. In steep sewers the head losses in the manholes must be minimized otherwise energy dissipation may cause flows out of the manhole covers. Because of the steep terrain, overland flows may cause extensive damage. Care must be taken to ensure clean transitions in the manhole benching and bends should not be greater than 45 degrees.

MoTI Section	1050		TAC Section	Not Applicable
--------------	------	--	-------------	----------------

### Foundation Excavation

**Figure 1050.K** presents volumes for concrete pipe storm sewer. **Figure 1050.L** presents volumes for corrugated steel pipe storm sewer. **Figure 1050.M** presents volumes for manholes.

For storm sewer foundation excavations greater than 1.2 m, the use of 1:1 side slopes or a trench box is required. The volumes in **Figures 1050.K and L** may have to be adjusted accordingly.

### Depth of Sewers

The depth of cover varies due to the type of pipe material used, magnitude of vehicular loads, the surrounding material, depth of frost penetration etc. Typically, storm sewers should have at least 1 m of cover between finished grade and the crown of the pipe in untraveled areas and not less than 1.5 m of cover under traveled areas.

**Table 1050.N** presents maximum cover over concrete pipe.



MoTI Section	1050	TAC Section	Not Applicable
--------------	------	-------------	----------------

Figure 1050.K Concrete Pipe Storm Sewer Foundation Excavation

CONCRETE PIPE			BEDDING							TRENCH EXCAVATION
Pipe Size Ø mm	Wall Thickness mm	Outside Diameter mm	Height(h) m	Width(w) m	Area m <sup>2</sup>	Pipe Area m <sup>2</sup>	Bedding Area m <sup>2</sup>	Bedding Agg.		Volume m <sup>3</sup> per m depth per lin. m
			A	B	( <sup>C</sup> A x B)	D	( <sup>E</sup> C - D)	Volume m <sup>3</sup>	Mass t	
200	32	264	0.564	0.864	0.487	0.055	0.433	0.433	0.908	0.864
250	37	324	0.624	0.924	0.577	0.082	0.494	0.494	1.038	0.924
300	51	402	0.702	1.002	0.703	0.127	0.576	0.576	1.211	1.002
375	57	489	0.789	1.089	0.859	0.188	0.671	0.671	1.410	1.089
450	64	578	0.878	1.178	1.034	0.262	0.772	0.772	1.621	1.178
525	70	665	0.965	1.265	1.221	0.347	0.873	0.873	1.834	1.265
600	95	790	1.090	1.390	1.515	0.490	1.025	1.025	2.152	1.390
675	102	879	1.179	1.479	1.744	0.607	1.137	1.137	2.388	1.479
750	108	966	1.266	1.566	1.983	0.733	1.250	1.250	2.624	1.566
900	121	1142	1.442	1.742	2.512	1.024	1.488	1.488	3.124	1.742
1050	133	1316	1.616	1.916	3.096	1.360	1.736	1.736	3.646	1.916
1200	146	1492	1.792	2.092	3.749	1.748	2.001	2.001	4.201	2.092

\*Multiply Trench Height (H) by Column 'F' to get TRENCH EXCAVATION VOLUME per linear metre

BEDDING AREA  
 $= (h \times w) - (\frac{\pi D^2}{4})$   
 COMPACTED GRANULAR AGGREGATE  
 Mass per m<sup>3</sup> = 2.1 t

NOTES:

1. In solid rock, use 0.6 m and increase the bedding accordingly.

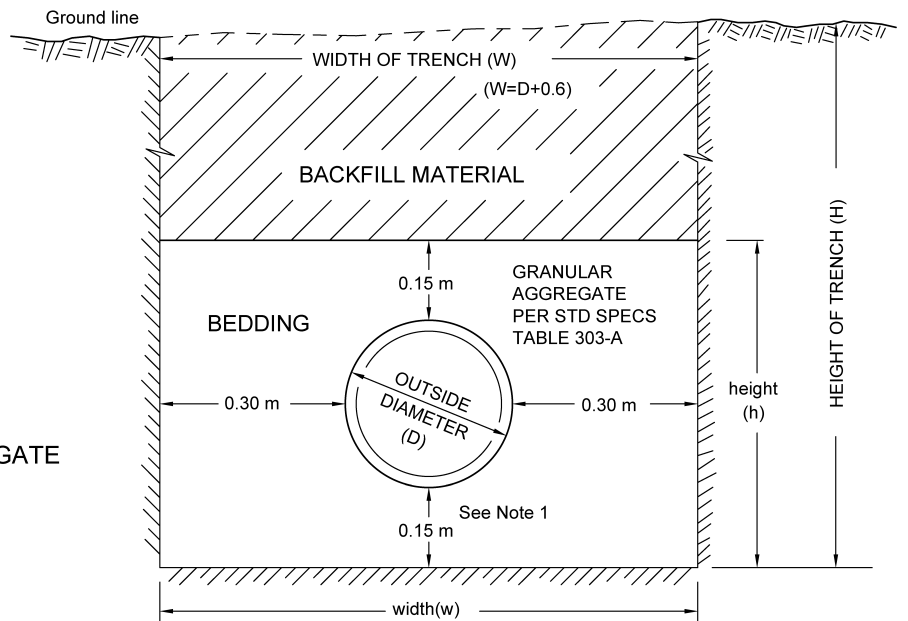

MoTI Section	1050	TAC Section	Not Applicable
--------------	------	-------------	----------------

Figure 1050.L Corrugated Steel Pipe Storm Sewer Foundation Excavation

CORR. STEEL PIPE			BEDDING							FOUNDATION EXCAVATION
PIPE SIZE Ø mm	WALL THICKNESS mm	OUTSIDE DIAMETER mm	Height(h) m	Width(w) m	Area m <sup>2</sup>	Pipe Area m <sup>2</sup>	Bedding Area m <sup>2</sup>	Bedding Agg.		Volume m <sup>3</sup> per m depth per lin. metre  F
			A	B	C (A x B)	D	E (C - D)	Volume m <sup>3</sup>	Mass tonnes	
200	-	200	0.650	0.800	0.520	0.031	0.489	0.489	1.026	0.800
250	-	250	0.700	0.850	0.595	0.049	0.546	0.546	1.146	0.850
300	-	300	0.750	0.900	0.675	0.071	0.604	0.604	1.269	0.900
400	-	400	0.850	1.000	0.850	0.126	0.724	0.724	1.521	1.000
500	-	500	0.950	1.100	1.045	0.196	0.849	0.849	1.782	1.100
600	-	600	1.050	1.200	1.260	0.283	0.977	0.977	2.052	1.200
700	-	700	1.150	1.300	1.495	0.385	1.110	1.110	2.331	1.300
800	-	800	1.250	1.400	1.750	0.503	1.247	1.247	2.619	1.400
900	-	900	1.350	1.500	2.025	0.636	1.389	1.389	2.917	1.500
1000	-	1000	1.450	1.600	2.320	0.785	1.535	1.535	3.223	1.600
1200	-	1200	1.650	1.800	2.970	1.131	1.839	1.839	3.862	1.800

\*Multiply Trench Height (H) by Column 'F' to get TRENCH EXCAVATION VOLUME per linear metre

BEDDING AREA  
 $= (h \times w) - (\frac{\pi}{4} D^2)$   
 COMPACTED GRANULAR AGGREGATE  
 Mass per m<sup>3</sup> = 2.1 tonnes

\*In Solid Rock, use 0.3m  
 - Increase bedding accordingly.

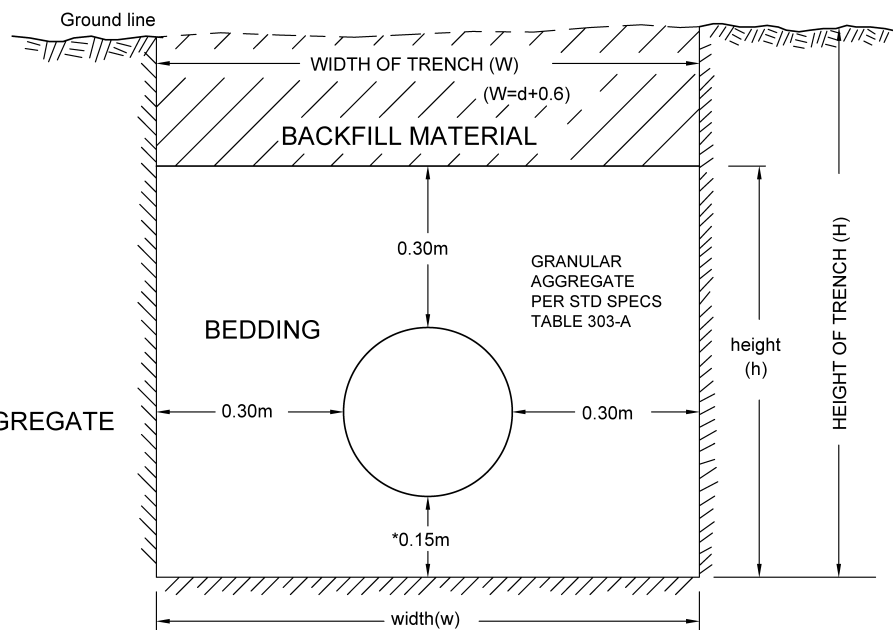

MoTI Section	1050	TAC Section	Not Applicable
--------------	------	-------------	----------------

**Figure 1050.M Foundation Excavation Volumes per Metre Depth of Manhole**

DIAMETER mm	WALL TH. mm	OUTSIDE DIAMETER m	EXCAVATION DIAMETER m	AREA EXCAVATION m <sup>2</sup>	VOLUME per m of depth m <sup>3</sup>	TYPE OF MATERIALS
900	2.8	0.930	2.130	3.563	3.563	Corr. Steel
	100	1.100	2.300	4.155	4.155	Concrete
1000	2.8	1.030	2.230	3.906	3.906	Corr. Steel
1050	115	1.280	2.480	4.831	4.831	Concrete
1200	2.8	1.230	2.430	4.638	4.638	Corr. Steel
	125	1.450	2.650	5.515	5.515	Concrete
1350	— . —	— . —	— . —	— . —	— . —	— . —
	165	1.680	2.880	6.514	6.514	Concrete
1400	2.8	1.430	2.630	5.433	5.433	Corr. Steel
1500	170	1.840	3.040	7.258	7.258	Concrete
1600	2.8	1.630	2.830	6.290	6.290	Corr. Steel
1650	185	2.020	3.220	8.143	8.143	Concrete
1800	2.8	1.830	3.030	7.211	7.211	Corr. Steel
	195	2.190	3.390	9.026	9.026	Concrete

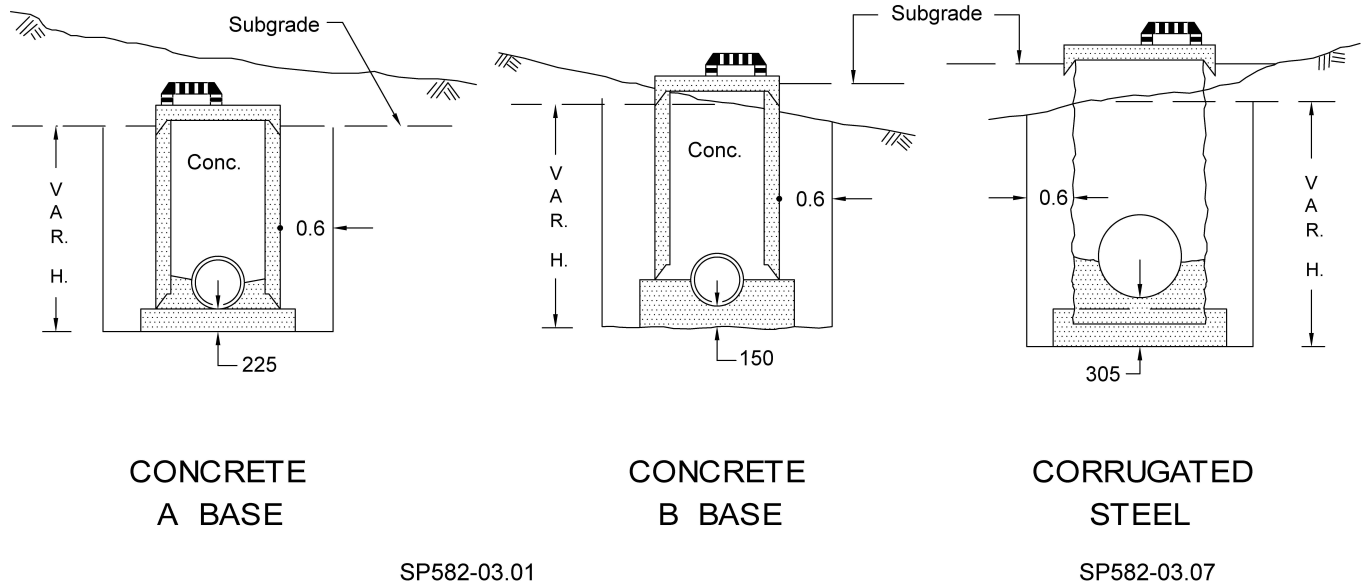

**NOTES:**

- TOP LIMIT FOR FOUNDATION EXCAVATION CALCULATION IS SUBGRADE OR GROUND LINE, WHICHEVER IS LOWER.
- NO FOUNDATION EXCAVATION WHEN RISER IS SMALLER THAN SEWER.

MoTI Section	1050		TAC Section	Not Applicable
--------------	------	--	-------------	----------------

**Table 1050.N Concrete Pipe Trench Installation**

**Design Data:**

1. Class “B” bedding.
2. Width of trench at pipe crown = transition width.
3. Backfill = sand and gravel at 1.92 tonnes/m<sup>3</sup>
4. Pipe strength - ASTM - C 14 and C 76.
5. Live Load CS-600
6. Safety Factor = 1.5

COVER IN METRES									
Diameter in	Non-reinf. C 14 - 3		Reinforced C 76 - 111		Reinforced C 76 - IV		Reinforced C 76 - V		Diameter in
	Max.	Min.	Max.	Min.	Max.	Min.	Max.	Min.	
200	6.4	0.3	-	-	-	-	-	-	200
250	5.2	0.4	-	-	-	-	-	-	250
300	4.2	0.4	-	-	4.8	0.4	6.1	0.3	300
375	3.8	0.4	-	-	5.0	0.4	6.2	0.3	375
450	3.7	0.4	-	-	5.1	0.4	6.3	0.3	450
525	3.7	0.4	3.4	0.5	5.1	0.3	6.3	0.2	525
600	3.8	0.4	3.5	0.5	5.2	0.3	6.4	0.2	600
675	3.6	0.4	3.5	0.5	5.2	0.2	6.5	0.2	675
750	3.4	0.4	3.5	0.4	5.3	0.2	6.6	0.2	750
900	3.0	0.4	3.6	0.3	5.3	0.2	6.6	0.2	900
1050	-	-	3.6	0.2	5.4	0.2	6.7	0.2	1050
1200	-	-	3.6	0.2	5.4	0.2	6.7	0.2	1200
1350	-	-	3.7	0.2	5.4	0.2	6.7	0.2	1350
1500			3.7	0.2	5.5	0.2	6.7	0.2	1500
1650			3.5	0.2	5.5	0.2	6.7	0.2	1650
1800			3.8	0.2	5.5	0.2	6.7	0.2	1800

MoTI Section	1050	TAC Section	Not Applicable
--------------	------	-------------	----------------

## 1050.09 STORM SEWER DESIGN SAMPLE

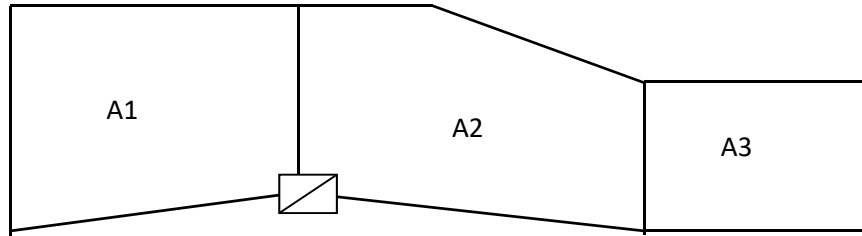

*Step 1* - Determine drainage areas A1, A2, etc. by planimetering area from map. Estimate values of runoff coefficient, C. Determine slopes, S, between catchbasins ←, ↑, etc.

*Step 2* - For drainage area, A1, assume the time of concentration,  $t_c$ , as 5-20 minutes. Look up rainfall intensity,  $i$ , from the IDF curves. Calculate the design flow using the Rational Method.

*Step 3* - Find diameter of pipe,  $d$ , between ← and ↑ using the design flow and Manning's Equation.

$$v = \frac{R^{0.67} S^{0.5}}{n} \quad \text{or} \quad Q = \frac{0.31d^{2.67} S^{0.5}}{n}$$

Assuming a pipe roughness coefficient,  $n$ , compute  $d$  from the formula and chose the next available size.

*Step 4* - Assuming full flow, estimate the travel time,  $t_t$ , from ← and ↑ using the following equation:

$$t_t = \frac{\text{pipe length}}{\text{velocity}}$$

*Step 5* - Assume  $t_c$  for inlet ↑ as  $t_c$  for ← +  $t_t$ . Look up  $i$ . Compute flows at ↑ from  $Q_2 = C_2 i (A_1 + A_2)$ .

*Step 6* - Size pipe between ↑ and → and keep going.

*Step 7* - Once the storm sewer system has been designed, the pipe network can be analyzed using a commercially available computer program.

### Problem

A storm drain, 150 m long, drains a residential area. The drainage area to the upstream end is 6 hectares and there is an additional 8 hectares before the downstream end. The ground is sloped at 1.0%. What is the design flow at the downstream end of the storm drain? (from both catchment areas).

### Solution

*Step 1* -  $A_1 = 6$  ha,  $A_2 = 8$  ha,  $C = 0.6$ ,  $S = 0.01$  m/m

*Step 2* - For drainage area A1 assume  $t_c = 20$  min. The 10-year rainfall intensity will be calculated using a formula for the area rather than the IDF curves.

$$i = 77e^{-0.0277t_c} = 77e^{-0.0277(20\text{min})} = 44\text{mm/hr}$$

The design flow is:

$$Q_1 = \frac{CiA_1}{360} = \frac{(0.6)(44\text{mm/hr})(6\text{ha})}{360} = 0.44\text{m}^3/\text{s}$$

*Step 3* - Assuming a pipe roughness,  $n = 0.013$ , find diameter of pipe.

$$d = \left( \frac{Qn}{0.31S^{0.5}} \right)^{0.375} = \left( \frac{(0.44\text{m}^3/\text{s})(0.013)}{(0.31)(0.01\text{m/m})^{0.5}} \right)^{0.375} = 0.53\text{m}$$

The next larger size is 600 mm diameter.

MoTI Section	1050	TAC Section	Not Applicable
--------------	------	-------------	----------------

The full flow velocity of a 600 mm diameter pipe is:

$$v = \frac{R^{0.67} S^{0.5}}{n} = \frac{(0.6\text{m} / 4)^{0.67} (0.01\text{m} / \text{m})^{0.5}}{0.013}$$

$$= 2.2\text{m} / \text{s}$$

Step 4 - The estimated travel time,  $t_t$ , through the pipe is:

$$t_t = \frac{\text{pipe length}}{\text{velocity}} = \frac{150\text{m}}{2.2\text{m} / \text{s}} = 68\text{s} = 1.1\text{min}$$

Step 5 - The time of concentration at the next inlet,  $t_c$  for A2, is:

$$t_c \text{ for A2} = t_c \text{ for A1} + t_t = 20 \text{ min} + 1.1 \text{ min} = 21.1 \text{ min}$$

The rainfall intensity is:

$$i = 77e^{-0.0277t_c} = 77e^{-0.0277(21.1\text{min})} = 43\text{mm} / \text{hr}$$

The combined design flow for both catchment areas is:

$$C_{1+2} = \frac{C_1 A_1 + C_2 A_2}{A_1 + A_2} = \frac{(0.6)(6\text{ha}) + (0.6)(8\text{ha})}{6\text{ha} + 8\text{ha}}$$

$$= 0.6$$

$$Q_2 = \frac{C_{1+2} i (A_1 + A_2)}{360}$$

$$= \frac{(0.6)(43\text{mm} / \text{hr})(6\text{ha} + 8\text{ha})}{360} = 1.0\text{m}^3 / \text{s}$$

The design flow at the downstream end of the storm drain is  $1 \text{ m}^3/\text{s}$ .

The above design method is best completed in tabular form.

MoTI Section	1060	TAC Section	Not Applicable
--------------	------	-------------	----------------

## 1060 DITCH INFILLING

### 1060.01 GENERAL

Land owners adjacent to Provincial Highways often find the roadside ditch is inconvenient when maintaining their property and aesthetically displeasing. The purpose of this policy is to ensure that where infilling of the ditch by the property owner is permitted, it complies with both the Ministry of Transportation & Infrastructure *Standard Specifications for Highway Construction* book and the *BC Supplement to TAC Geometric Design Guide* and ensures proper drainage is maintained. Infilling of roadside ditches by adjacent property owners at their own cost shall generally be permitted.

Exceptions - Infilling of ditches will not be permitted:

- Where the ditch forms an integral part of a flood control system
- Where water storage in the ditch provides a significant reduction in peak flow rates
- Within 3 m of a cross culvert (unless an approved culvert basin with end walls or a manhole is installed)
- Adjacent to any road other than rural minor roads and secondary roads and urban minor and local streets
- In areas used as fish habitat, unless approved by the local environmental agencies
- In areas not approved by the District Manager, Transportation

Access to properties will be limited to designated driveways.

The ditch infilling works, once installed and approved, shall become the property of the Ministry.

The Ministry reserves the right to change, raise, lower or realign the highway in such a way as to render the ditch infilling works ineffective without any recompense to the property owner.

All works on Ministry Right-of-Way will be to appropriate Ministry standards. If the District Manager, Transportation cannot supply adequate direction for design by the property owner, ditch infilling works must be designed and constructed under the supervision of a Professional Engineer at the property owner's expense.

It is the responsibility of the property owner to contact the environmental agencies and, where necessary, obtain their approvals for the works, including Ministry permission for ditch infilling.

Where required by the District Manager, Transportation, the property owner shall submit a design for review and approval or employ a Professional Engineer to design and supervise construction of ditch infilling works. Roadside ditch infilling, when permitted by the Ministry, shall conform to the applicable Ministry *Standard Specifications* for both materials and installation of culverts, including, but not limited to, the following:

### 1060.02 SIZING

A hydraulic analysis shall be done to determine the correct size of culvert for the site.

Culverts shall be a minimum of 400 mm in diameter. Driveway culverts which do not meet this standard shall be upgraded.

### 1060.03 INSTALLATION

Invert elevations shall be a minimum of 700 mm below finished grade of centreline, except where otherwise approved by the Ministry representative. Culvert grade shall generally conform to existing ditch grade with a desirable minimum grade of 0.5%. Bedding shall conform to Ministry *Standard Specifications*, including trench excavation and refilling, to form a gravel bed (see **Figure 1060.A**).

In locations where the road subgrade is not free draining gravel, a 300 mm thick blanket of drain rock shall be placed on the road side bank of the ditch to a minimum depth of 1 m below highway grade. A 100 mm diameter perforated pipe shall be

MoTI Section	1060	TAC Section	Not Applicable
--------------	------	-------------	----------------

placed in the toe of the drain rock running parallel to the culvert and shall be drained into the culvert by means of a T or Y junction every 30 m. Clean outs for the perforated pipe shall be installed every 30 m.

#### 1060.04 CROSS CULVERTS

Ditch infilling shall not be allowed within 3 m of cross culverts unless a proper culvert basin with end walls or a manhole is installed.

#### 1060.05 INLET AND OUTLET DITCHES

Existing inlet and outlet ditches to culverts, roadside ditches and cross ditches shall not be blocked by ditch infilling.

#### 1060.06 BACKFILLING

Methods and materials used in backfill shall comply with Ministry *Standard Specifications*. Maximum extent of the backfill will be the top of SGSB. The finished ground profile will form a swale parallel to the highway with a minimum cross slope down from the highway shoulder of 5% **and a minimum** 1% longitudinal grade. A typical cross section is shown in **Figure 1060.A**.

#### 1060.07 CATCH BASINS

Catch basins with removable grates at ground level (for surface drainage and culvert cleanout) shall be installed at 20 m intervals, in the bottom of the swale to drain into the culvert, and immediately upstream of driveways, or as **otherwise required**.

#### 1060.08 PERIMETER AND ROOF DRAINS

Any roof or perimeter drains which enter the ditch must be joined into the culvert, with a saddle branch, above the centreline of the culvert. Cleanouts will be installed at the edge of the R/W.

#### 1060.09 PLANTING

Planting of shrubs or trees by property owners or their agents on Highway R/W will not be permitted.

#### 1060.10 TRAFFIC CONTROL

Appropriate traffic control, signage, safety equipment and clothing must be used during construction.



MoTI Section	1060	TAC Section	Not Applicable
--------------	------	-------------	----------------

Figure 1060.A Ditch Infilling / Culverting

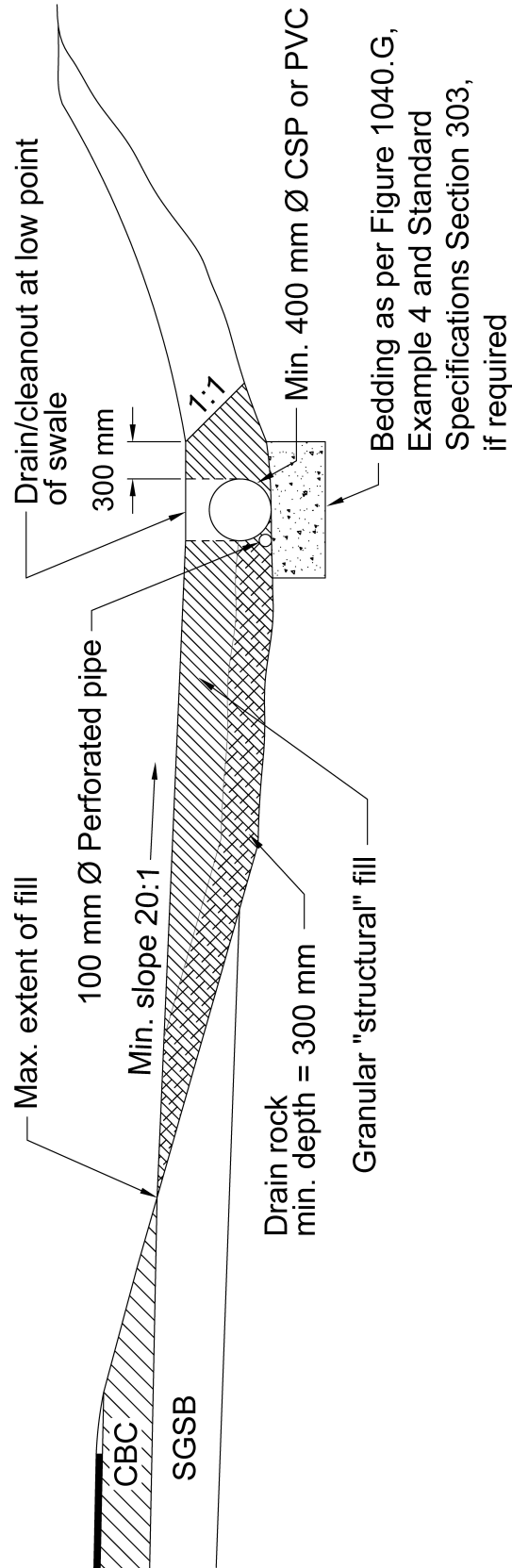

MoTI Section	1060		TAC Section	Not Applicable
--------------	------	--	-------------	----------------

**This page is  
intentionally left blank**