

MoTI Section	400		TAC Section	Not Applicable
--------------	-----	--	-------------	----------------

400 CROSS SECTIONS CHAPTER

410 CROSS SECTIONS.....410-1

430 CROSS SECTION ELEMENTS430-1

440 TYPICAL RURAL SECTIONS FOR BC.....440-1

450 TYPICAL URBAN SECTIONS FOR BC.....450-1

**400 CROSS SECTION CHAPTER
TABLES**

430.A Cross Section Elements.....430-1

430.B Design Widths for Shoulder Bikeways.....430-1

**400 CROSS SECTION CHAPTER
FIGURES**

440.A Typical Section – Rural Local Undivided440-1

440.B Typical Section – Rural Collector and Arterial440-2

440.C Typical Section – Rural Freeway/Expressway - No Development to 6 Lanes440-3

440.D Typical Section – Rural Freeway/Expressway - With Development to 6 Lanes.....440-4

440.E Alternate Shoulder Detail – Pavement Depth Reduction.....440-5

440.F Shoulder Detail with Roadside Barrier or Drainage Curb440-6

440.G Typical Wall Sections440-7

440.H Solid Rock Cut Sections.....440-8

440.I Disposal of Waste Excavation440-9

450.A Typical Urban Fill Section.....450-1

450.B Typical Urban Cut Section.....450-2

MoTI Section	400		TAC Section	Not Applicable
--------------	-----	--	-------------	----------------

**This page is
intentionally left blank**

MoTI Section	410		TAC Section	Not Applicable
--------------	-----	--	-------------	----------------

410 CROSS SECTIONS

410.01 INTRODUCTION

The following deals with the production of cross sections, which form part of the information for construction contracts. Because of the variety of designs, universal statements about the content of cross sections are difficult; therefore, this is a general discussion.

Cross sections provide a third dimension to plan and profile that ties the horizontal and vertical alignment to the ground. They are used for such purposes as:

- Identifying areas of conflict due to the interaction of the design template and the existing ground.
- Helping to identify R/W requirements.
- Determining embankment and excavation project quantities.
- Determining various roadway design features such as drainage curbs, roadside barrier, ditching and cross culvert locations, etc.
- Assisting Construction supervisors to better understand the designer's intent for such things as driveways, structures and drainage.
- Assisting contractors in the bidding process for evaluating station to station quantities, cut and fill slopes, and potential construction problems.

410.02 FORMAT

Cross sections may be plotted on roll stock or D size sheets. On roll stock, each end of the roll will have the same information as shown on the title or key page of the contract drawings. Each L-line shall start a new stack.

On D size cut sheets, there shall be a title page with the same information as above. Each page shall identify the L-line and/or road name or structure that the sections represent. Each L-line shall start with a new stack.

Submissions for the purpose of design reviews are often provided as half size copies on 11" x 17" sheets. Adobe PDF files are also convenient for review. Contact the appropriate regional Senior Highway Design Engineer to verify what format will be acceptable for design reviews.

For rural projects, use a natural scale of 1:100 or 1:250 for both horizontal and vertical.

Urban projects usually require the larger horizontal scale of 1:100. The vertical scale may be exaggerated and is normally 1:50. A scale of 1:25 is optional where needed.

The major grid shall typically be at 5 m intervals, although 10 m may be used on mountainous projects.

The control line of the cross sections should align with a major grid line.

Rural spacing for plotted cross sections shall be no greater than 20 m on tangents and curves, with 10 m spacing for rock sections and 5 m spacing at retaining walls and other critical areas. Cross sections at horizontal alignment curve and spiral transition stations should also be included. The design cross section spacing requirements specified in Section 1280.10.05.01.02 of the Civil 3D Terms of Reference Project Data Format and Workflow Requirements must be followed. This may result in significantly more closely spaced cross sections for design purposes; however, the final plotted cross sections do not necessarily have to include all of the design cross sections.

Urban spacing shall be 10 m for both tangents and curves with 5 m spacing at retaining walls. Cross sections at accesses and other critical areas may be needed to provide additional information.

The cross sections are plotted with the chainage increasing from the bottom of the page to the top for each stack.

MoTI Section	410		TAC Section	Not Applicable
--------------	-----	--	-------------	----------------

410.03 CONTENT

Existing Features:

The following list is included as an example of the type of information typically needed to identify the existing features. The uniqueness of each project will determine what information needs to be shown.

- Existing ground line with features identified.
- Original ground elevation at the control line.
- Station of each cross section.
- Existing R/W boundaries.
- Existing utilities and drainage (e.g. access and cross culverts).
- Structures (e.g., retaining walls, endwall, fences, buildings, etc.).
- All accesses – a cross section at each centreline.
- Side roads – a cross section at each centreline. Identify the road.

Proposed Features:

The following list is included as an example of the type of information typically needed to transmit the intent of the design. The uniqueness of each design will determine exactly what information needs to be shown.

- Finished grade line and cross fall with proposed elevation at centreline or control line.
- Complete roadway structure and subgrade cross fall if different from finished grade.
- Elevations of toe of fill slope and lowest ditch point.
- Proposed R/W boundaries.
- Stratum lines and stripping.
- Drainage and utility locations, except utility pole lines.

- Show typical location of utility poles once per stack, if generally parallel.
- Clear zone limit, where applicable.
- Indicate the foreslope, backslope and fill slope values once per stack and each time the slopes change.
- Structures (e.g., retaining walls, endwall, fences, buildings, etc.) within the proposed R/W.
- Provide necessary information on the composition and staging of embankments (e.g., lightweight core, surcharge, etc.).
- Sound berms with slopes and elevation.
- Drainage information (e.g., drainage arrows to indicate flow direction).
- Curb and gutter.
- Roadside and median barrier.

Special Sections:

- Special sections shall be interspersed as required to pick up other features such as ground breaks and changes in ground type (i.e., change from Type A to Type D material as defined in Standard Specification 201.11) and accesses, etc.
- Cross sections at creek crossings, existing large culverts with drainage channels, etc.
- Cross sections at critical control points.

Optional Useful Information:

- Areas and volumes (cut and fill) for each type of material, excluding pavement and gravels, should be shown on the cross sections. This data can assist the contractors in preparing their bid.
- Properties Branch may request cross sections at property boundaries.

MoTI Section	430	TAC Section	4 and 5.3.2.5
--------------	-----	-------------	---------------

430 CROSS SECTION ELEMENTS

Table 430.A summarizes the cross section elements for BC highways according to Design Speed, Classification and Design Volumes. (Also refer to Figures 440.A through 440.H). See Section 620 for Clear Zone discussion.

Table 430.A Cross Section Elements

Road Class	Total Design Volume	Lane Width (m)	Paved Shoulder Width ¹ (m)	Design Speed ² (km/h)	Normal X-Fall	Fill Slope (desirable)
LVR ³	≤ 200 ADT	Refer to Section 510 ³	0.5 Gravel	30-90	Refer to Section 510 ³	2 to 1
RLU		3.6	1.0 ⁴	50-80	0.02 m/m	4 to 1
RCU	≤ 450 DHV ⁵	3.6	1.5	50-80		4 to 1
	> 450 DHV ⁵		1.5	60-90		4 to 1
RCD		3.6	2.5	60-90		4 or 5 to 1
RAU	< 200 DHV ⁵	3.6	1.5	70-90		4 or 5 to 1
	≤ 450 DHV ⁵	3.6	2.0	70-90		
	> 450 DHV ⁵	3.6	2.5	80-100		
RAD		3.7	3.0	80-100		4 or 5 to 1
RED		3.7	3.0	80-120	4 or 5 to 1	
RFD		3.7	3.0	80-120	4 or 5 to 1	

- 1 Minimum width is 1.5 m for Shoulder Bikeway when applicable. See Table 430.B below.
- 2 Justification is required where less than the maximum design speed for each classification is selected, except for RED and RFD where justification is required for a design speed less than 110 km/h.
- 3 See Section 510 for Low-volume Roads details.
- 4 Typical minimum shoulder width required to nearest edge of roadside barrier is 1.3 m.
- 5 On a typical rural highway, the DHV is about 15% of the ADT.

Table 430.B Design Widths for Shoulder Bikeways

Controlling Condition	Minimum Design Width (m)
For Most Cases, except as below	1.5
For Design Speed ≥ 70 km/h and SADT > 5,000	2.0
For Design Speed > 80 km/h and SADT > 10,000	2.5
All Freeways and Expressways	3.0

- The travel lane(s) next to a shoulder bikeway should be at least 3.6 m wide
- SADT = Summer Average Daily Traffic (July and August).

MoTI Section	430		TAC Section	4 and 5.3.2.5
--------------	-----	--	-------------	---------------

**This page is
intentionally left blank.**

MoTI Section	440	TAC Section	Figure 4.13.2
--------------	-----	-------------	---------------

Figure 440.A Typical Section - Rural Local Undivided

N.T.S.

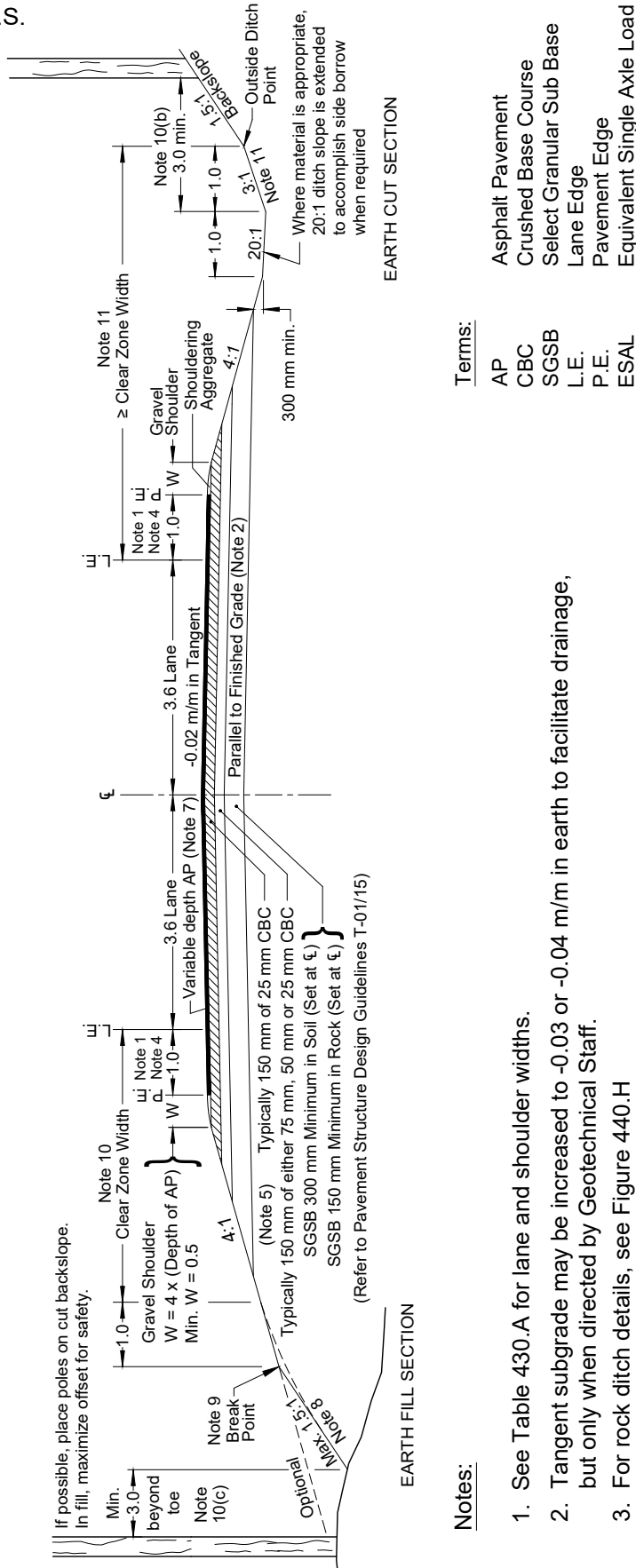

MoTI Section	440	TAC Section	Figures 4.13.4, 6, 8 & 10
--------------	-----	-------------	---------------------------

Figure 440.B Typical Section - Rural Collector and Arterial

N.T.S.

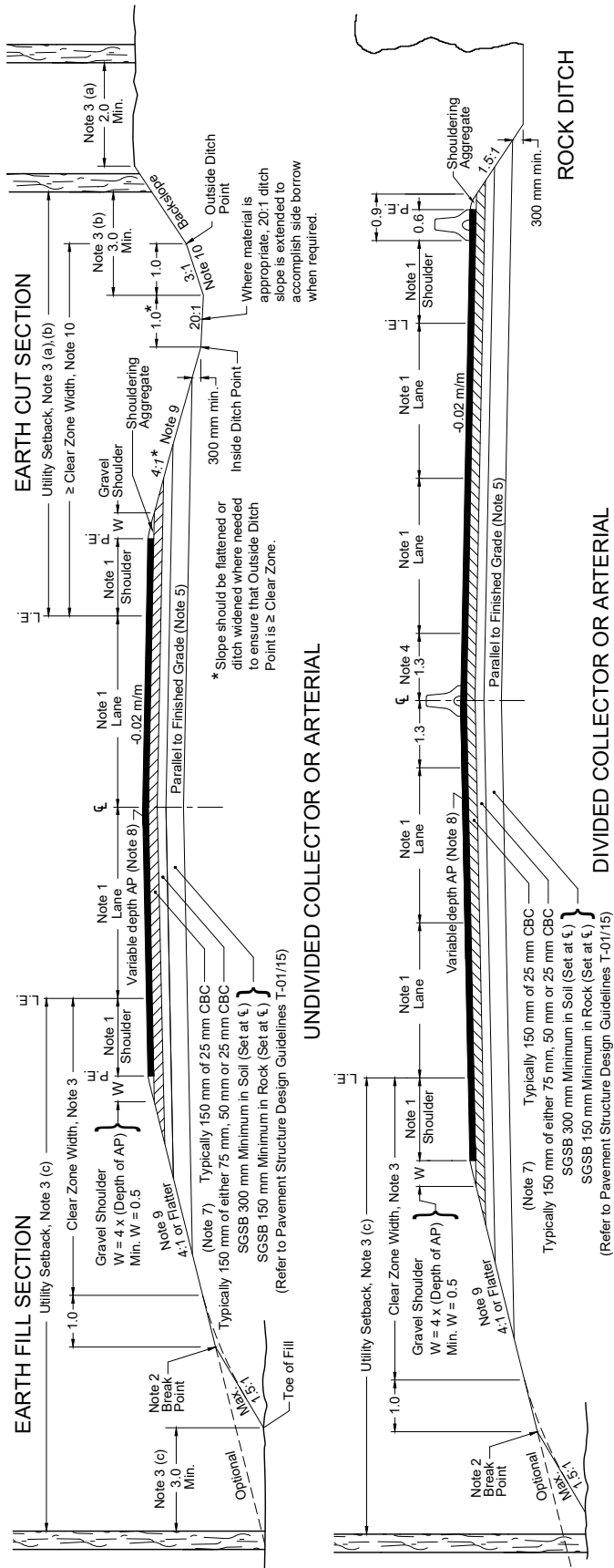

Terms:

AP	Asphalt Pavement
CBC	Crushed Base Course
SGSB	Select Granular Sub Base
L.E.	Lane Edge
P.E.	Pavement Edge
ESAL	Equivalent Single Axle Load

Notes:

1. See Table 430.A for Lane and Shoulder Widths.
2. Rounding or "smoothing" at Break Point to be done during construction.
3. Clear Zone is a function of Speed and Traffic Volume. Clear Zone Width to be in accordance with the requirements in Section 620. Utilities should be located outside of the Clear Zone. The desirable location of utility poles shall be, in order of preference: (a) min. 2 m beyond top of cut, (b) min. 3 m beyond lowest ditch point, (c) min. 3 m beyond toe of fill. See the current edition of the Ministry's Utility Policy Manual for additional placement guidelines.
4. Minimum half-width is 1.3 m from Lane Edge to Centreline. Check for SSD along median barrier on curves. Median barrier may not be required on 4-Lane Collectors or Arterials with low volumes and is not generally used on 2-Lane Collectors or Arterials.
5. Tangent subgrade may be increased to -0.03 or -0.04 m/m in earth to facilitate drainage, but only when directed by Geotechnical Staff.
6. See Figure 440.F through 440.H for Barrier/Drainage Curb, Retaining Wall and Rock Ditch Details.
7. These are "typical" gravel depths to be used in the absence of a specific Geotechnical recommendation.
8. Type "A", $\geq 20,000,000$ ESALs, use min. 150 mm of AP; or Type "B", 100,000 to 20,000,000 ESALs, use 75 mm to 150 mm of AP. Where pavement is ≥ 100 mm, full depth extends only 0.6 m into the paved shoulder, depending on shoulder width. See Figure 440.E for this Alternate Shoulder Detail.
9. Ditch slopes and fill slopes steeper than 4:1 must be evaluated for barrier need.
10. The 3:1 ditch slope is not mandatory. A single backslope may be used starting at the low point of the ditch. Achieving clear zone width is desirable, but if the backslope is relatively smooth and obstacle-free, it may not be a significant hazard, regardless of its distance from the roadway.

MoTI Section	440	TAC Section	Figure 4.13.12
--------------	-----	-------------	----------------

Figure 440.D Rural Freeway/Expressway - With Development to 6 Lanes

N.T.S.

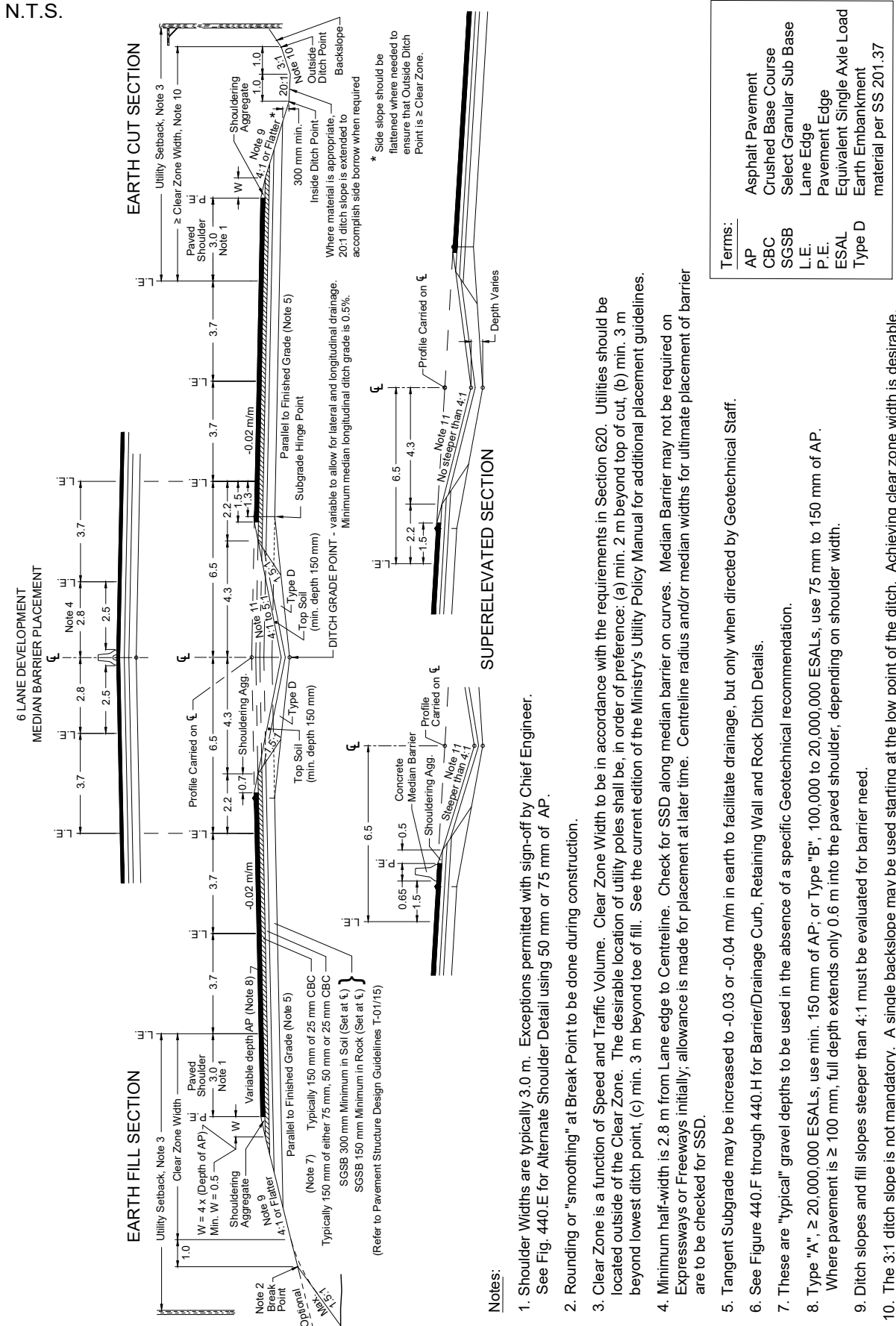

MoTI Section	440	TAC Section	Not Applicable
--------------	-----	-------------	----------------

Figure 440.E Alternate Shoulder Detail - Pavement Depth Reduction

N.T.S.

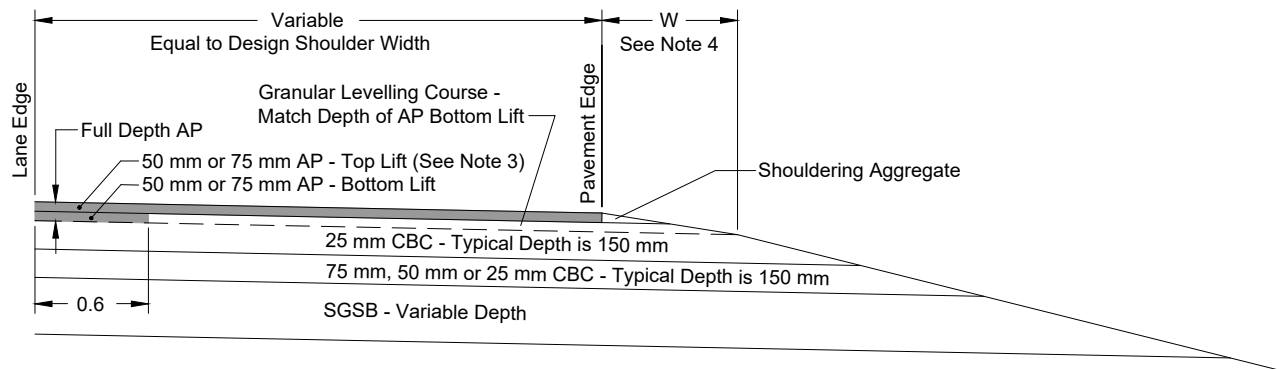

Notes:

1. Pavement depth reduction may not be appropriate for shoulders that are less than 2.5 m wide; consider using full depth pavement for the entire shoulder.
2. Levelling material may be 19 mm Shouldering Aggregate or 25 mm CBC, subject to the ability to properly compact the material.
3. Pavement depths of 150 mm may also be constructed in three 50 mm thick lifts.
4. Gravel shoulder width 'W' to be the greater of:
 - (a) 0.5 m, or
 - (b) 4 x (Full Depth AP)

MoTI Section	440	TAC Section	Not Applicable
--------------	-----	-------------	----------------

Figure 440.F Shoulder Detail with Roadside Barrier or Drainage Curb

N.T.S.

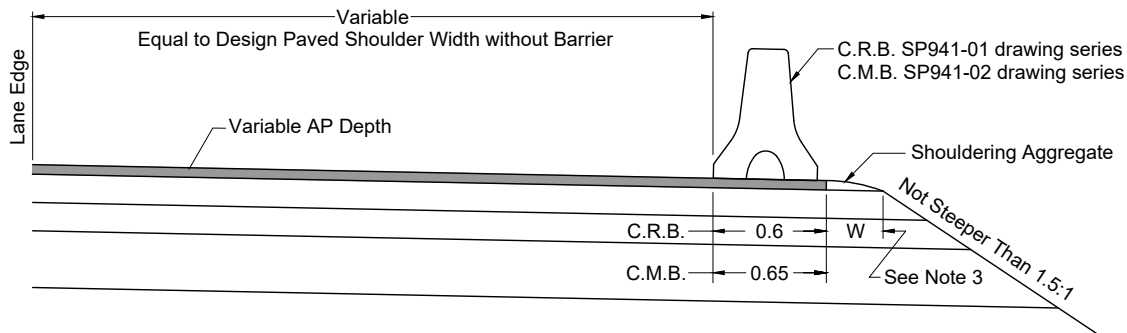

TYPICAL FOR NEW ROADWAY CONSTRUCTION

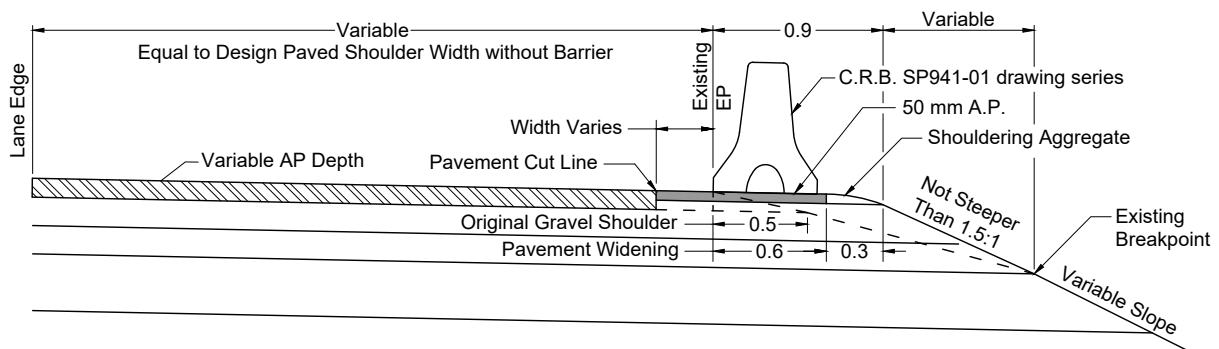

TYPICAL FOR WIDENING AN EXISTING ROADWAY

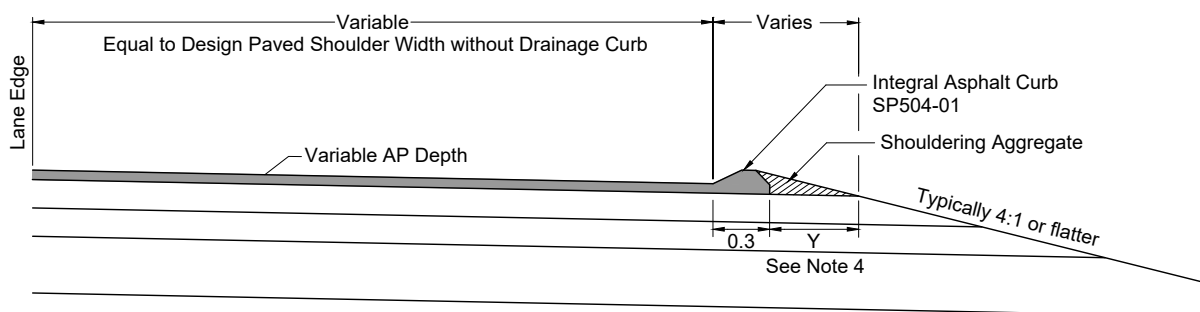

TYPICAL FOR NEW ROADWAY CONSTRUCTION

Notes:

1. Barrier and/or curbing on truck lanes should match the existing shoulder width; however, the width may be up to 1.0 m less than the normal shoulder width, but must be at least 1.5 m wide where cyclists are present or 1.3 m wide where there are no cyclists.
2. Curbing shall not be used behind roadside barrier.
3. Gravel shoulder width 'W' to be the greater of:
 - (a) 0.3 m, or
 - (b) 3 x (Depth of AP)
4. Gravel shoulder width 'Y' to be:
 - 4 x (Depth of AP + 0.075 m)

MoTI Section	440	TAC Section	Not Applicable
--------------	-----	-------------	----------------

Figure 440.G Typical Wall Sections

N.T.S.

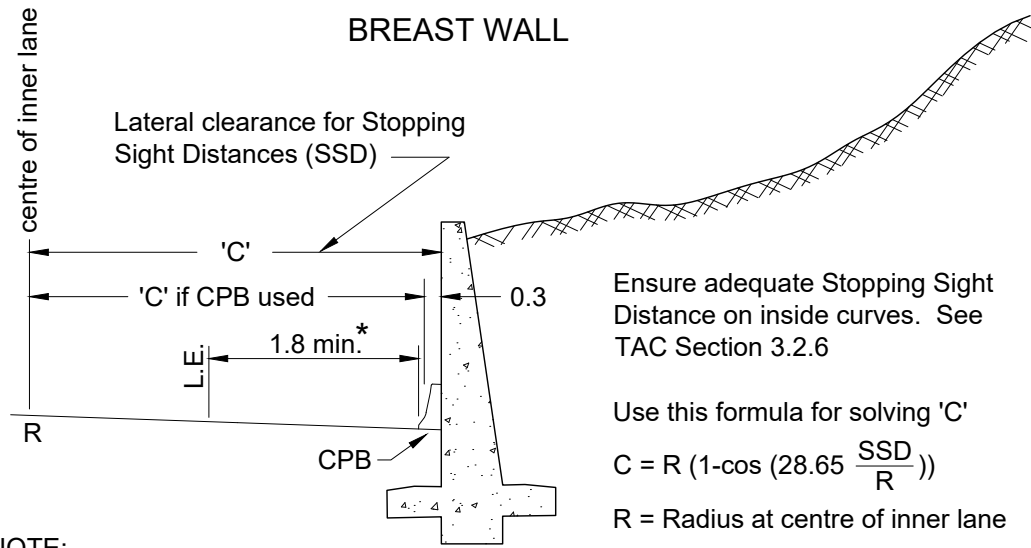

NOTE:

The addition of Concrete Pier Barrier (CPB) should be considered when designing a Breast Wall. If CPB is used, the 'C' distance shall be measured to a point 0.3 m from the wall.

(refer to Standard Specification Dwg. SP941-02.01.05 to 941-02.01.07 for CPB details)

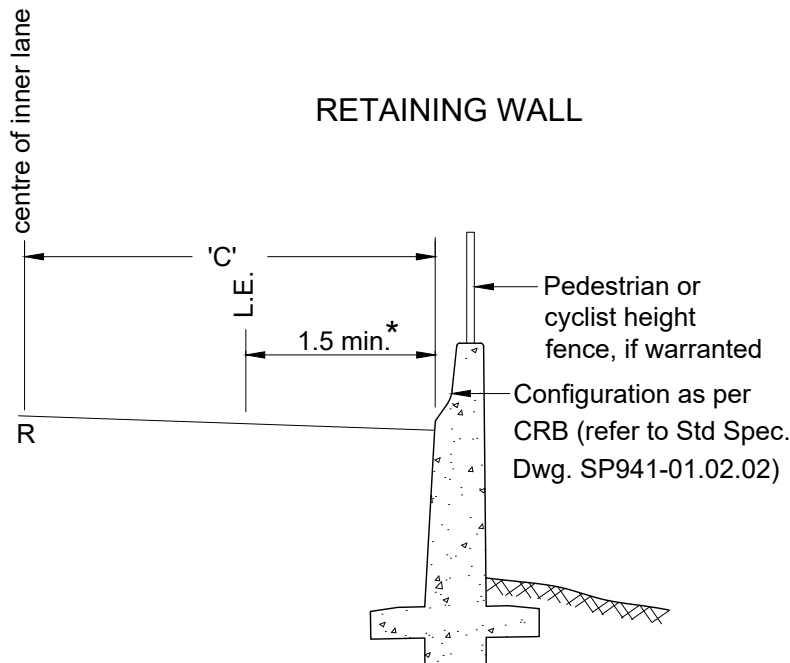

BARRIER SETBACK ON WALL SECTION

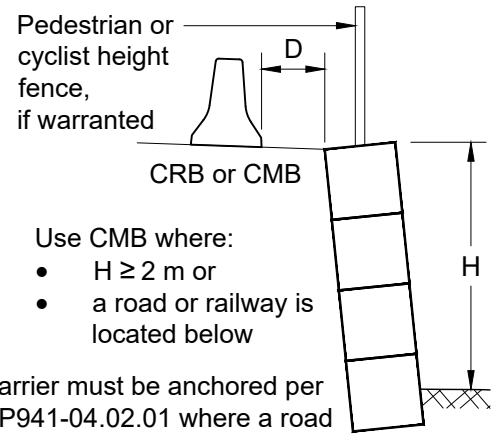

NOTE:

Increase lateral clearance to accomplish SSD.

* Desirable width is the same as the paved shoulder. This drawing is for lateral clearance only. Consult other sources for wall designs.

Consider anchoring barrier where D < 0.5 m

Recommended setback from wall for non-anchored barrier:

- D = 0.5 m for ≤ 80 km/h design speed
- D = 1.0 m for > 80 km/h design speed

MoTI Section	440	TAC Section	Not Applicable
--------------	-----	-------------	----------------

Figure 440.H Solid Rock Cut Sections

N.T.S.

CONCEPTUAL AND PRELIMINARY DESIGN FOR LOCAL, COLLECTOR, ARTERIAL, EXPRESSWAY AND FREEWAY

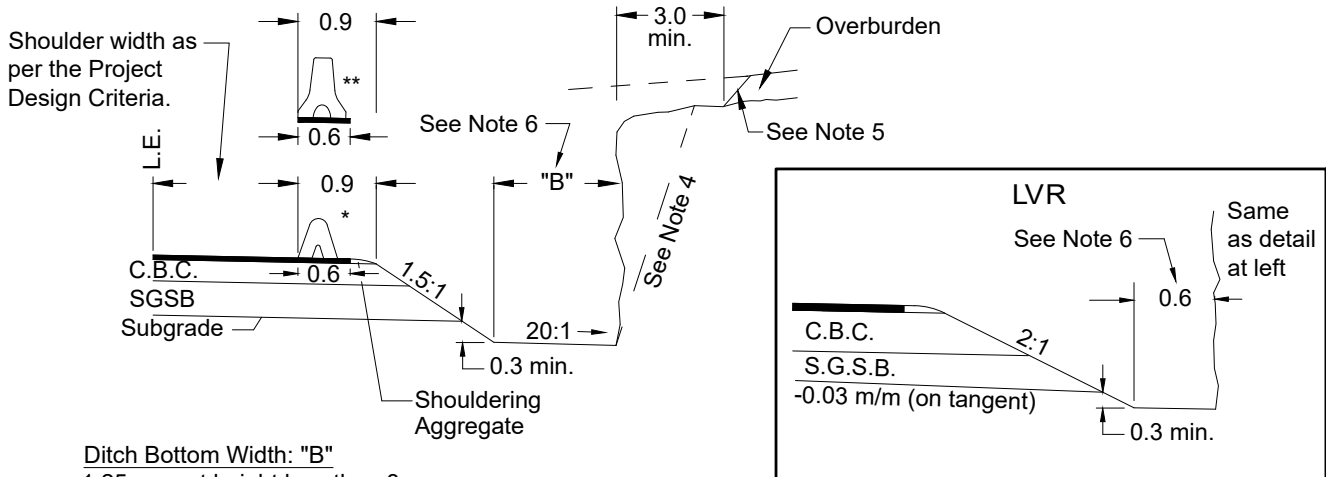

Ditch Bottom Width: "B"

- 1.25 m - cut height less than 8 m;
- 1.25 m - cut height up to 10 m for less than 100 m along alignment;
- 2.75 m - cut height of 8 m or more except as stated above.

Cut height greater than 8 m requires a Geotechnical site specific design.

Ditch widths > 2.75 m may be recommended for very high rock cut sections.

* Use CLB on inside curve only. See Standard Specification SP941-01.01 drawing series.

** Use CRB on outside curve or tangent. See Standard Specification SP941-01.02 drawing series.

ALTERNATE CONCEPTUAL AND PRELIMINARY DESIGN FOR LOCAL, COLLECTOR, ARTERIAL, EXPRESSWAY AND FREEWAY

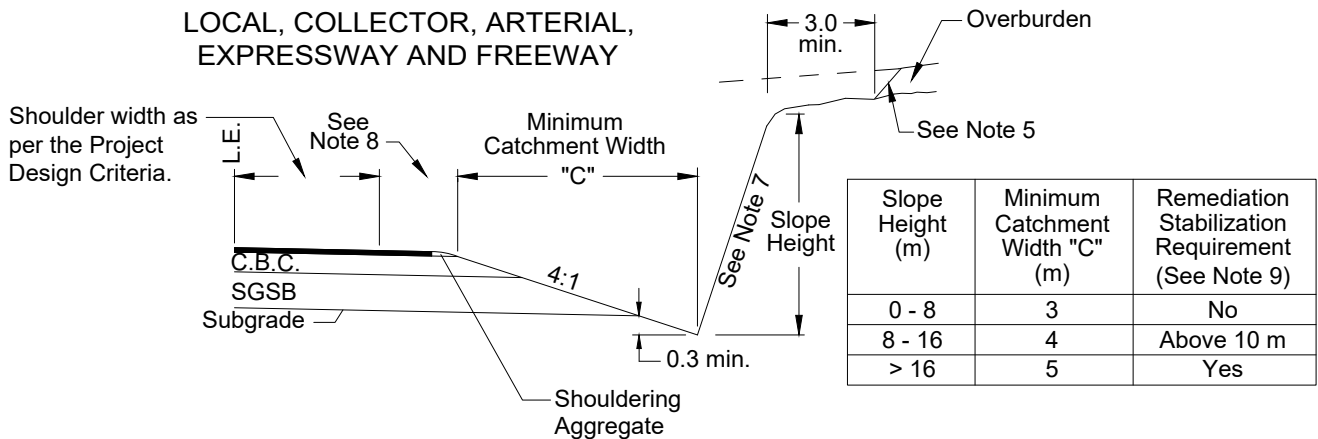

Notes:

1. Rock cut height is measured from the outside ditch point to the top of the rock face, excluding overburden.
2. All cuts to be excavated to subgrade line.
3. A geotechnical investigation is to be carried out for all cuts greater than 8 m and for all cuts where geohazards may exist (i.e. within or beyond construction cross section limits).
4. Use a vertical backslope unless a flatter slope is recommended in the geotechnical report.
5. Overburden slope is normally 1.5:1, but may vary depending upon the type of material.
6. Increase the ditch bottom width dimension to ensure lateral clearance for SSD in curves.
7. For the 'Alternate' detail, use 0.25:1 backslope unless a different slope is recommended in the geotechnical report.
8. Barrier, clear zone and drainage requirements will be reviewed during the detailed design phase.
9. Remediation/slope stabilization design involves potentially the application of mesh on slope heights > 10 m, pattern bolt installation, shotcrete application and/or catch fence/barrier.

MoT Section	440	TAC Section	Not Applicable
-------------	-----	-------------	----------------

Figure 440.I Disposal of Waste Excavation

N.T.S.

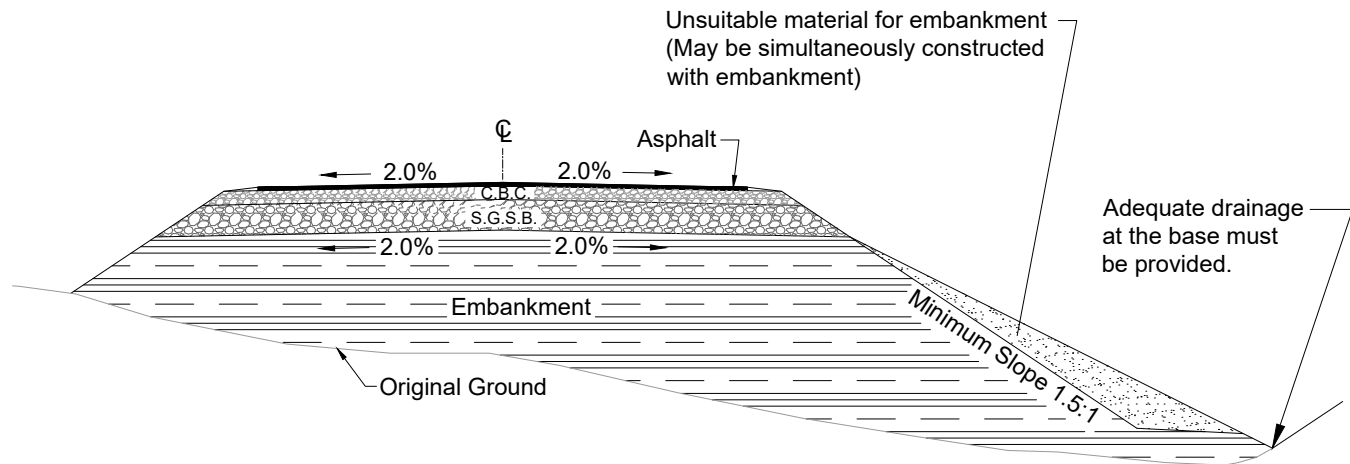

Notes:

1. Material considered unsuitable for embankment construction may be disposed within the right-of-way as shown in the diagram.
2. The unsuitable material shall be deposited below the base of the select granular subbase (SGSB) so that SGSB drainage is not compromised.
3. In the case of rock fill embankment, adequate drainage shall be provided through the unsuitable material so that no pore pressure can build up within the rock embankment.
4. The unsuitable material placed on the embankment slope must be stable against sloughing.

MoTI Section	440		TAC Section	Not Applicable
--------------	-----	--	-------------	----------------

**This page is
intentionally left blank**

MoTI Section	450	TAC Section	4.13
--------------	-----	-------------	------

Figure 450.A Typical Urban Fill Section

N.T.S.

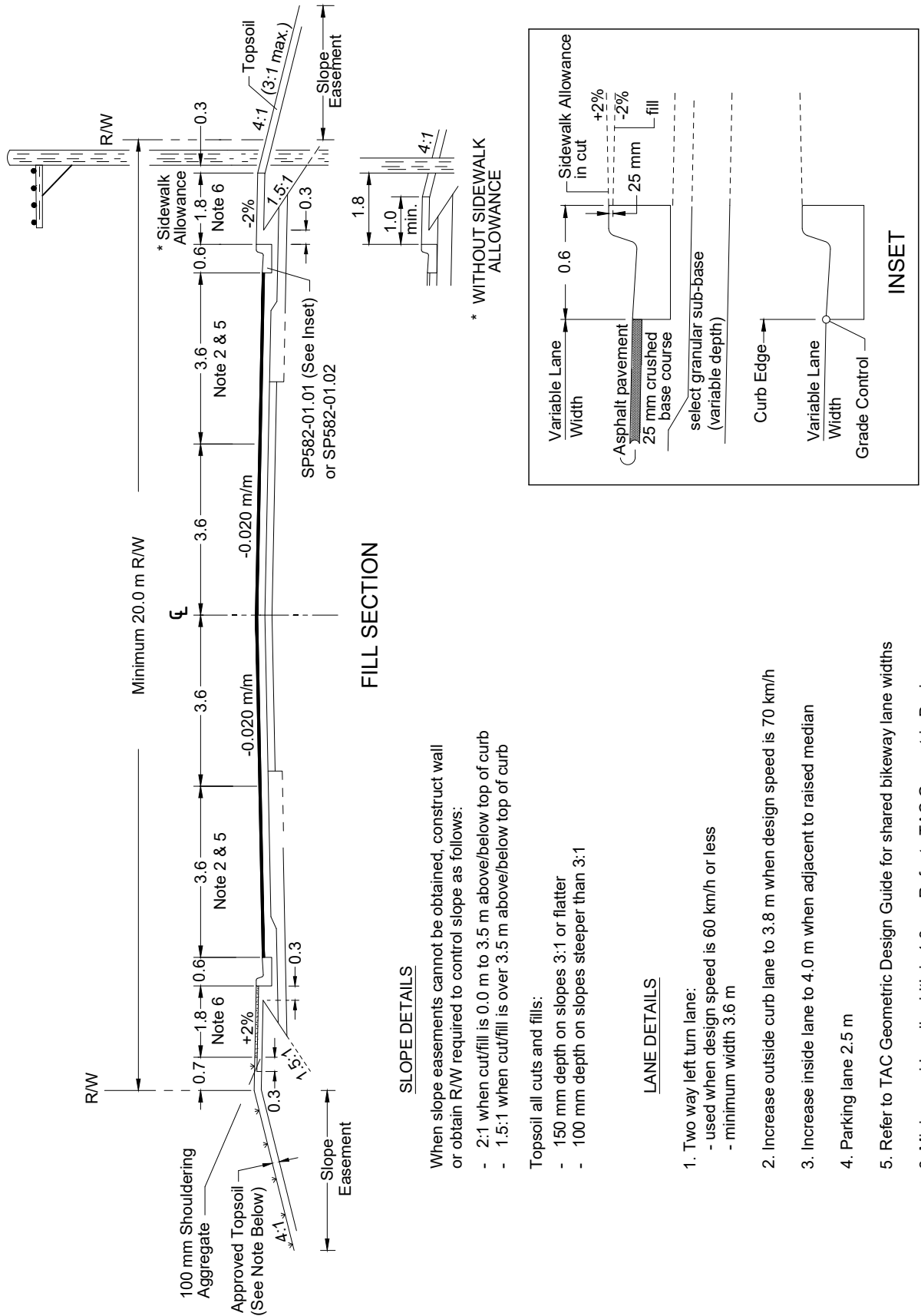

FILL SECTION

SLOPE DETAILS

When slope easements cannot be obtained, construct wall or obtain R/W required to control slope as follows:

- 2:1 when cut/fill is 0.0 m to 3.5 m above/below top of curb
- 1.5:1 when cut/fill is over 3.5 m above/below top of curb

Topsoil all cuts and fills:

- 150 mm depth on slopes 3:1 or flatter
- 100 mm depth on slopes steeper than 3:1

LANE DETAILS

1. Two way left turn lane:
 - used when design speed is 60 km/h or less
 - minimum width 3.6 m
2. Increase outside curb lane to 3.8 m when design speed is 70 km/h
3. Increase inside lane to 4.0 m when adjacent to raised median
4. Parking lane 2.5 m
5. Refer to TAC Geometric Design Guide for shared bikeway lane widths
6. Minimum sidewalk width is 1.8 m. Refer to TAC Geometric Design Guide for situations that require greater sidewalk widths.

MoTI Section	450	TAC Section	4.13
--------------	-----	-------------	------

Figure 450.B Typical Urban Cut Section

N.T.S.

