

PLAN

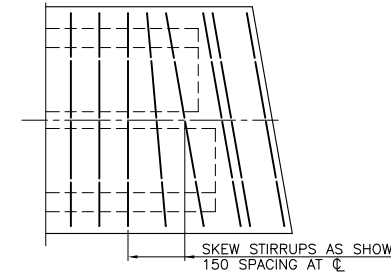

TYPICAL STIRRUP LAYOUT AT GIRDER ENDS

ESTIMATED MASS	
STRINGER MK. 500/10/E/10°	10 495 kg
STRINGER MK. 500/10/I/10°	10 105 kg

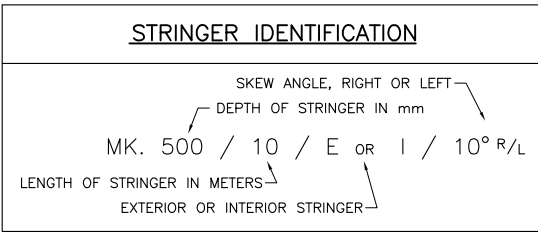

NOTES

- DESIGN SPECIFICATIONS: CAN/CSA-S6-06, BC MoT SUPPLEMENT TO S6-06.
- DESIGN LOAD: LIVE LOAD: CL-625 & BCL-625, DEAD LOAD: DESIGNED FOR 100mm CONCRETE OVERLAY.
- STRINGERS SHALL BE MANUFACTURED IN ACCORDANCE WITH THE M.O.T. STANDARD SPECIFICATION 415: MANUFACTURE OF PRECAST AND PRESTRESSED CONCRETE MEMBERS.
- PRESTRESSING STRANDS SHALL BE 13 ϕ (7 WIRE) UNCOATED LOW RELAXATION STRANDS, C.S.A. G279M-1982, 1862 MPa GRADE OR EQUIVALENT. MINIMUM ULTIMATE TENSILE STRENGTH = 184 kN/STRAND. STRAND TENSION IMMEDIATELY BEFORE RELEASE = 136.2 kN/STRAND.
- CONCRETE: MINIMUM COMPRESSIVE STRENGTH OF CONCRETE AT TIME OF RELEASE OF STRANDS = 27MPa, AT 28 DAYS = 35MPa.
- REINFORCING STEEL SHALL CONFORM TO C.S.A. G30.18M GRADE 400R.
- REINFORCING STEEL SHALL HAVE 35mm MINIMUM COVER UNLESS OTHERWISE NOTED.
- ALL REINFORCING MARKED "ME" IS EPOXY COATED.
- LAP OF BARS FOR SPLICES TO BE AS FOLLOWS UNLESS NOTED OTHERWISE:
10M BARS - 450
10ME BARS - 600
SPLICES TO BE STAGGERED.
- BOTTOM EDGES OF STRINGERS SHALL BE CHAMFERED 20mm.
- LIFTING DEVICES SATISFACTORY TO THE ENGINEER SHALL BE PROVIDED OVER THE BEARINGS. ONLY VERTICAL LIFTS WILL BE PERMITTED. CARE SHALL BE TAKEN TO PREVENT SUDDEN IMPACT LOADS ON THE STRINGERS.
- ENDS OF PRESTRESSING STRANDS SHALL BE TREATED AS FOLLOWS:
EMBEDDED IN CONCRETE: PAINTED WITH A GALVANIZING AGENT.
EXPOSED: A MINIMUM 3mm COAT OF THIXOTROPIC EPOXY AS SHOWN. MANUFACTURERS INSTRUCTIONS TO BE STRICTLY ADHERED TO.
- TOP OF BOXES SHALL HAVE A SAND BLASTED FINISH FOR CONCRETE OVERLAY AND FLOAT FINISH FOR NO OVERLAY OR MEMBRANE AND ASPHALT OVERLAY.
- THE CONCRETE IMMEDIATELY SURROUNDING ALL LIFTING DEVICES SHALL HAVE A FORMED RECESS 65mm DEEP. THE RECESS SHALL BE THOROUGHLY SANDBLASTED IN THE SHOP. AFTER ERECTION, THE LIFTING DEVICE SHALL BE BURNT OFF AT THE BOTTOM OF THE RECESS AND THE RECESS SHALL BE PATCHED WITH AN APPROVED NON-SHRINK GROUT.

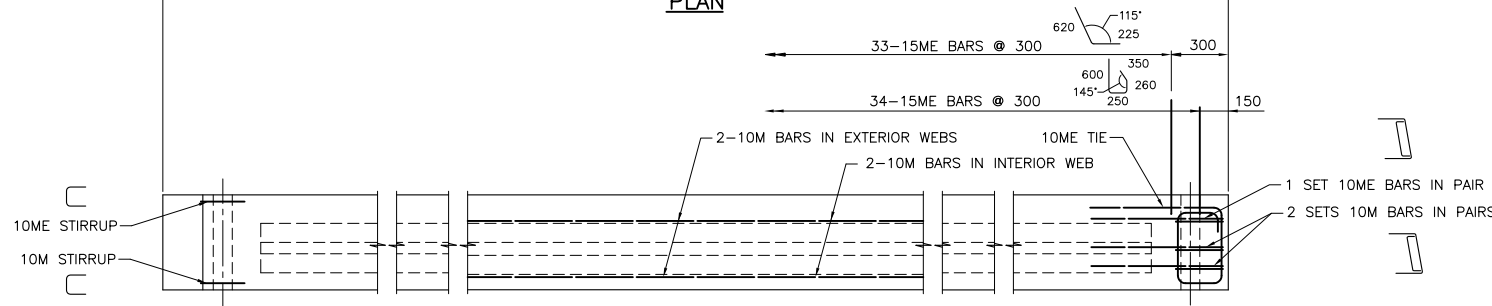

ELEVATION
EXTERIOR STRINGER (AS SHOWN)
INTERIOR STRINGER (SIMILAR EXCEPT AS NOTED)
SCALE 1:20

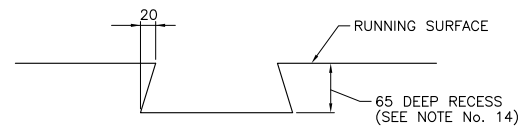

LIFTING DEVICE RECESS DETAIL
SCALE 1:5

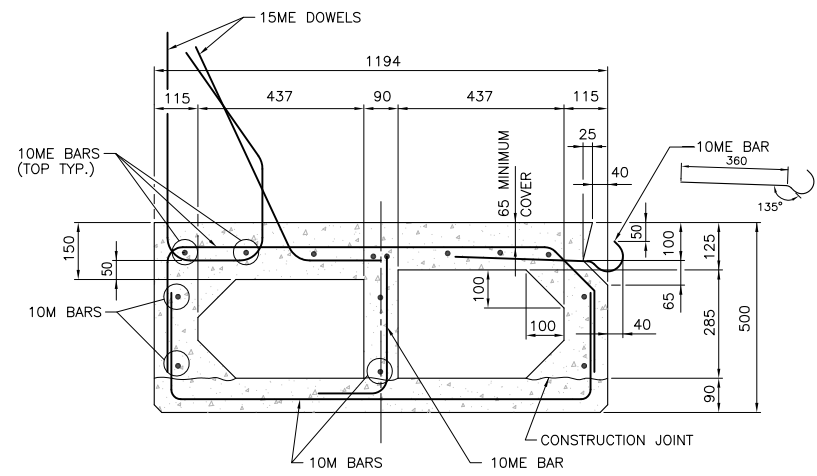

TYPICAL SECTION THROUGH EXTERIOR STRINGER
SCALE 1:10

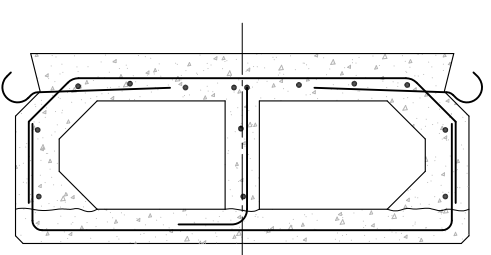

TYPICAL SECTION THROUGH INTERIOR STRINGER
SCALE 1:10

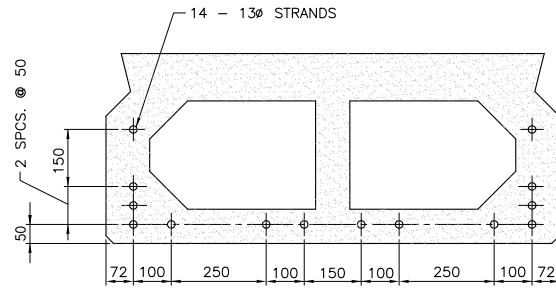

PRESTRESSING STRAND LAYOUT
SCALE 1:10

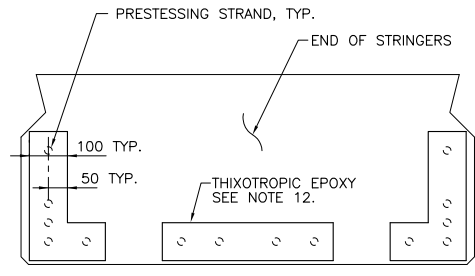

THIXOTROPIC EPOXY LAYOUT
SCALE 1:10

Rev	Date	Description	Init
C	07-06-28	DESIGN CODE REVISIONS	W.H.K.
B	93-02-04	GENERAL	J.E.S.
A	92-11-12	LIFTING DEVICE RECESS & NOTES	K.L.

REVISIONS

BRITISH COLUMBIA Ministry of Transportation & Infrastructure
Bridge Engineering

STANDARD TWIN CELL
CONCRETE BOX STRINGER
MK. 500/10/E/10° & MK. 500/10/I/10°

PREPARED UNDER THE DIRECTION OF ORIGINAL SIGNED BY B. BARNEWALL SENIOR BRIDGE DESIGN AND CONSTRUCTION STANDARDS ENGINEER DATE 93/02/12	DESIGNED BY IM DATE 07-07-10 CHECKED BY RM DATE 07-07-10 DRAWN BY WHK DATE 07-06-31 SCALE AS NOTED NEGATIVE No.
FILE No.	PROJECT No.
REG.	DRAWING No. 2978-6