



Ministry of
Transportation
and Infrastructure

PROJECT NO. 35478

HWY 97 DETOUR - COMMOTION CREEK BRIDGE

DIRECTOR, ENGINEERING	REGIONAL DIRECTOR
DATE YYYY-MM-DD	DATE YYYY-MM-DD

PLAN PGP1874A (ESMT,
NOT ON TITLE)

D.L. 1122

PLAN PGP16964 & KAP305H (HWY RW)

JOHN HART HIGHWAY #97

MAX. 45m LENGTH OF
STRUCTURE (BY OTHERS)

PEACE RIVER DISTRICT

PT SE 1/4 DL 1122
PID 015-145-131
PART IN ALR

DESIGN SPEED 60 km/h

	START	CURVE 1	CURVE 2	CURVE 3	CURVE 4	CURVE 5	END
R		1700.000 Lt	200.000 Rt	200.000 Lt	200.000 Lt	200.000 Rt	
Δ		0°40'26.64"	12°51'46.24"	16°44'15.25"	16°10'30.80"	16°10'30.80"	
Δ c		0°00'00.00"	1°24'13.28"	5°16'42.29"	4°42'57.84"	4°42'57.84"	
A.D.1		13.334	42.576	49.464	48.461	48.461	
A.D.2		26.667	42.576	49.464	48.461	48.461	
ARC		0.000	4.900	18.425	16.462	16.462	
Ext		0.046	1.602	2.489	2.346	2.346	
e	N/A	N/A	N/A	N/A	N/A	N/A	N/A
Ls1		40.000	40.000	40.000	40.000	40.000	
Os1		0°40'26.64"	5°43'46.48"	5°43'46.48"	5°43'46.48"	5°43'46.48"	
Ls2			40.000	40.000	40.000	40.000	
Os2			5°43'46.48"	5°43'46.48"	5°43'46.48"	5°43'46.48"	
PI	9+39.531	9+52.864	10+22.106	11+13.895	12+56.316	13+52.779	14+00.78
N.	163386.242	163388.916	163403.601	163402.608	163442.290	163494.072	163507.527
E.	569317.134	569330.197	569397.864	569489.899	569627.205	569709.134	569755.690

	START	CURVE 1	CURVE 2	CURVE 3	CURVE 4	CURVE 5	END
R		1700.000 Lt	200.000 Rt	200.000 Lt	200.000 Lt	200.000 Rt	
Δ		0°40'26.64"	12°51'46.24"	16°44'15.25"	16°10'30.80"	16°10'30.80"	
Δ c		0°00'00.00"	1°24'13.28"	5°16'42.29"	4°42'57.84"	4°42'57.84"	
A.D.1		13.334	42.576	49.464	48.461	48.461	
A.D.2		26.667	42.576	49.464	48.461	48.461	
ARC		0.000	4.900	18.425	16.462	16.462	
Ext		0.046	1.602	2.489	2.346	2.346	
e	N/A	N/A	N/A	N/A	N/A	N/A	N/A
Ls1		40.000	40.000	40.000	40.000	40.000	
Os1		0°40'26.64"	5°43'46.48"	5°43'46.48"	5°43'46.48"	5°43'46.48"	
Ls2			40.000	40.000	40.000	40.000	
Os2			5°43'46.48"	5°43'46.48"	5°43'46.48"	5°43'46.48"	
PI	9+39.531	9+52.864	10+22.106	11+13.895	12+56.316	13+52.779	14+00.78
N.	163386.242	163388.916	163403.601	163402.608	163442.290	163494.072	163507.527
E.	569317.134	569330.197	569397.864	569489.899	569627.205	569709.134	569755.690





MINISTRY OF TRANSPORTATION
AND INFRASTRUCTURE
NORTHERN REGION
HIGHWAY ENGINEERING AND GEOMATICS

PLAN

HWY 97 DETOUR - COMMOTION CREEK BRIDGE

SCALE 0 5 1:500 25m

CAD FILENAME RR-NNN-100

PLOT DATE 22/08/2017

REV	DATE	REVISIONS	NAME

DESIGNED _____	RL DATE 2017-07-05
QUALITY CONTROL _____	DATE _____
QUALITY ASSURANCE _____	DATE _____
DRAWN _____	DEC DATE 2017-07-05

SENIOR DESIGNER _____	DATE 2017-07-05
FILE NUMBER 171-06935-00	PROJECT NUMBER 35478
REG R3	DRAWING NUMBER R3-308-101Dtr
REV -	REV -

I:\171-06935-00 - Highway 97 - Commotion Creek\DWG\Trans\DrawingProduction\100_Plan\RR-NNN-100.dwg
 Plotted August 22, 2017

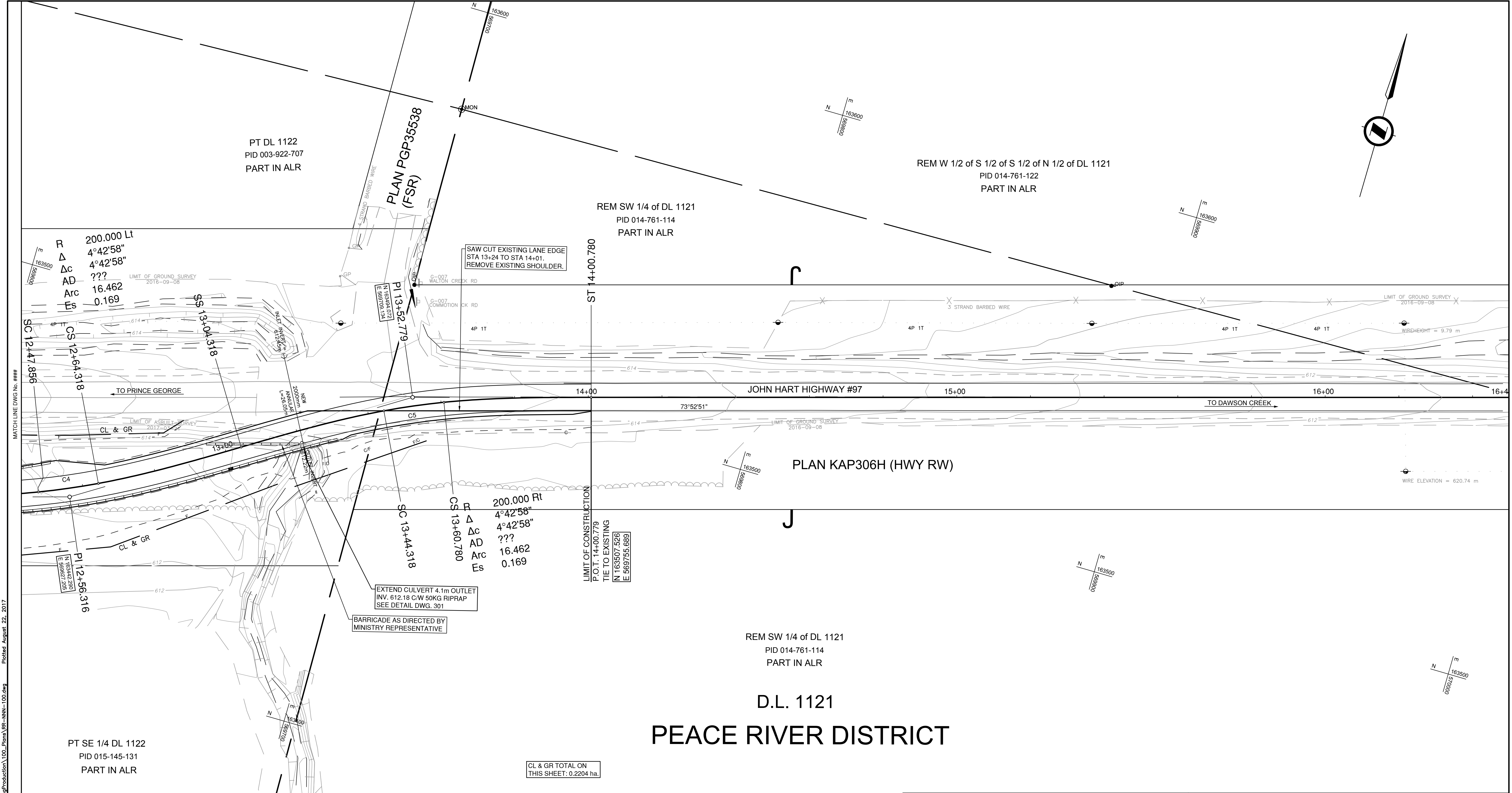

D.L. 1121
PEACE RIVER DISTRICT

DESIGN SPEED 60 km/h

A:\171-06935-00 - Highway 97 - Commotion Creek\DWG\Drawings\Production\100_Plan\RR-NNN-100.dwg
 Plotted August 22, 2017

				MINISTRY OF TRANSPORTATION AND INFRASTRUCTURE NORTHERN REGION HIGHWAY ENGINEERING AND GEOMATICS																																																							
SCALE		CAD FILENAME: RR-NNN-100 PLOT DATE: 22/08/2017		PLAN HWY 97 DETOUR - COMMOTION CREEK BRIDGE																																																							
<table border="1" style="width: 100%; border-collapse: collapse;"> <thead> <tr> <th>REV</th> <th>DATE</th> <th>REVISIONS</th> <th>NAME</th> </tr> </thead> <tbody> <tr><td> </td><td> </td><td> </td><td> </td></tr> <tr><td> </td><td> </td><td> </td><td> </td></tr> <tr><td> </td><td> </td><td> </td><td> </td></tr> <tr><td> </td><td> </td><td> </td><td> </td></tr> <tr><td> </td><td> </td><td> </td><td> </td></tr> <tr><td> </td><td> </td><td> </td><td> </td></tr> <tr><td> </td><td> </td><td> </td><td> </td></tr> <tr><td> </td><td> </td><td> </td><td> </td></tr> <tr><td> </td><td> </td><td> </td><td> </td></tr> <tr><td> </td><td> </td><td> </td><td> </td></tr> </tbody> </table>		REV	DATE	REVISIONS	NAME																																									DESIGNED: _____ RL DATE: 2017-07-05 QUALITY CONTROL: _____ DATE: _____ QUALITY ASSURANCE: _____ DATE: _____ SENIOR DESIGNER: _____ DATE: 2017-07-05 DRAWN: _____ DEC DATE: 2017-07-05		<table border="1" style="width: 100%; border-collapse: collapse;"> <tr> <td>FILE NUMBER</td> <td>PROJECT NUMBER</td> <td>REG</td> <td>DRAWING NUMBER</td> <td>REV</td> </tr> <tr> <td>171-06935-00</td> <td>35478</td> <td>R3</td> <td>R3-308-102Dtr</td> <td>-</td> </tr> </table>		FILE NUMBER	PROJECT NUMBER	REG	DRAWING NUMBER	REV	171-06935-00	35478	R3	R3-308-102Dtr	-
REV	DATE	REVISIONS	NAME																																																								
FILE NUMBER	PROJECT NUMBER	REG	DRAWING NUMBER	REV																																																							
171-06935-00	35478	R3	R3-308-102Dtr	-																																																							

A:\171-06935-00 - Highway 97 - Commotion Creek\DWG\Tran\DrawingProduction\200_Profiles\RR-NNN-200.dwg Plotted August 22, 2017

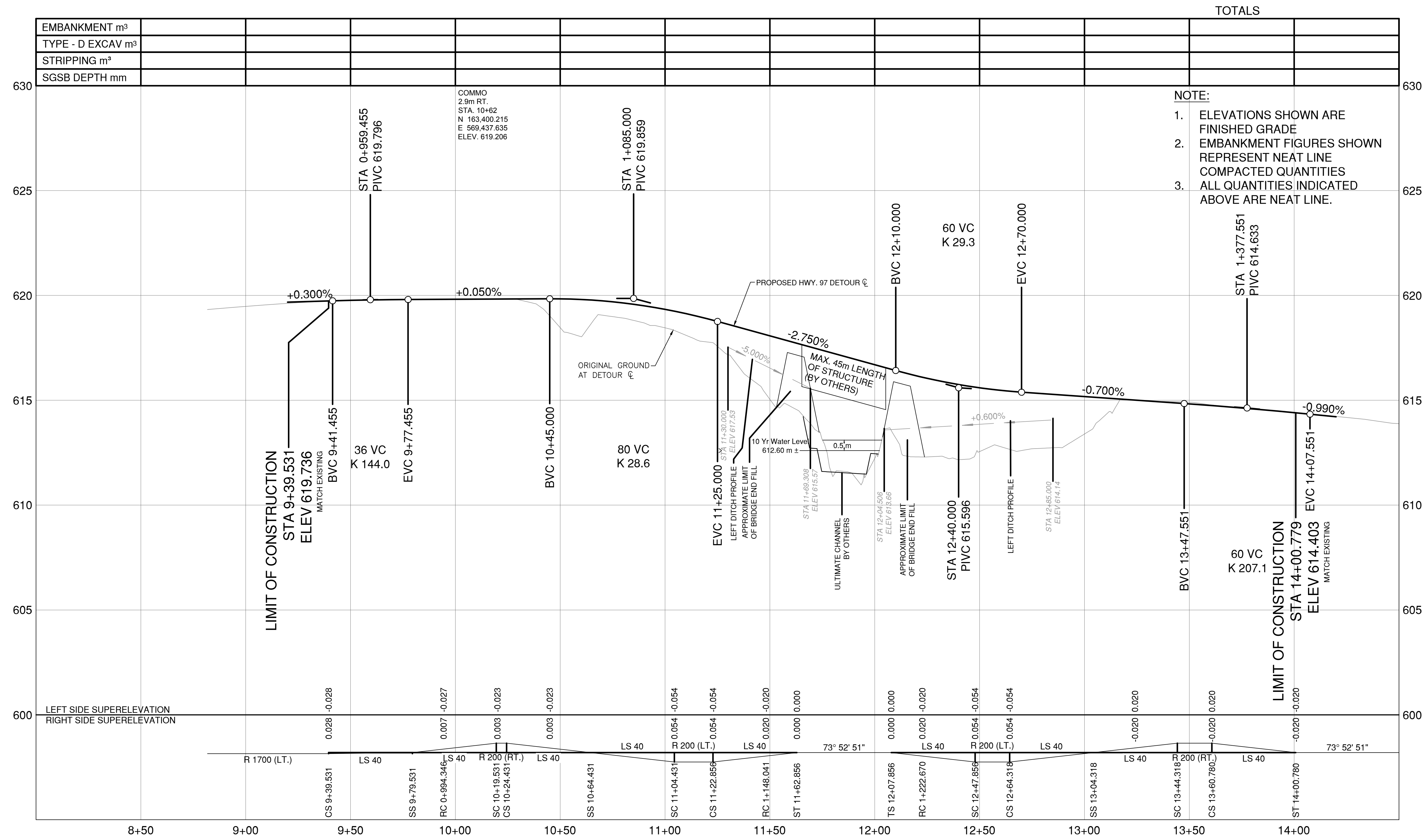

NOTE:

- ELEVATIONS SHOWN ARE FINISHED GRADE
- EMBANKMENT FIGURES SHOWN REPRESENT NEAT LINE COMPACTED QUANTITIES ALL QUANTITIES INDICATED ABOVE ARE NEAT LINE.
-

DESIGN SPEED 60 km/h

MINISTRY OF TRANSPORTATION AND INFRASTRUCTURE
NORTHERN REGION
HIGHWAY ENGINEERING AND GEOMATICS

SCALE: 0 10 50m H 1:1000 V 1:100

CAD FILENAME: RR-NNN-200 PLOT DATE: 22/08/2017

REV	DATE	REVISIONS	NAME

PROFILE

HWY 97 DETOUR - COMMOTION CREEK BRIDGE

DESIGNED	RL	DATE	2017-07-05
QUALITY CONTROL		DATE	
QUALITY ASSURANCE		DATE	
SENIOR DESIGNER		DATE	2017-07-05
DRAWN	DEC	DATE	2017-07-05

FILE NUMBER	PROJECT NUMBER	REG	DRAWING NUMBER	REV
171-06935-00	35478	R3	R3-308-201Dtr	-

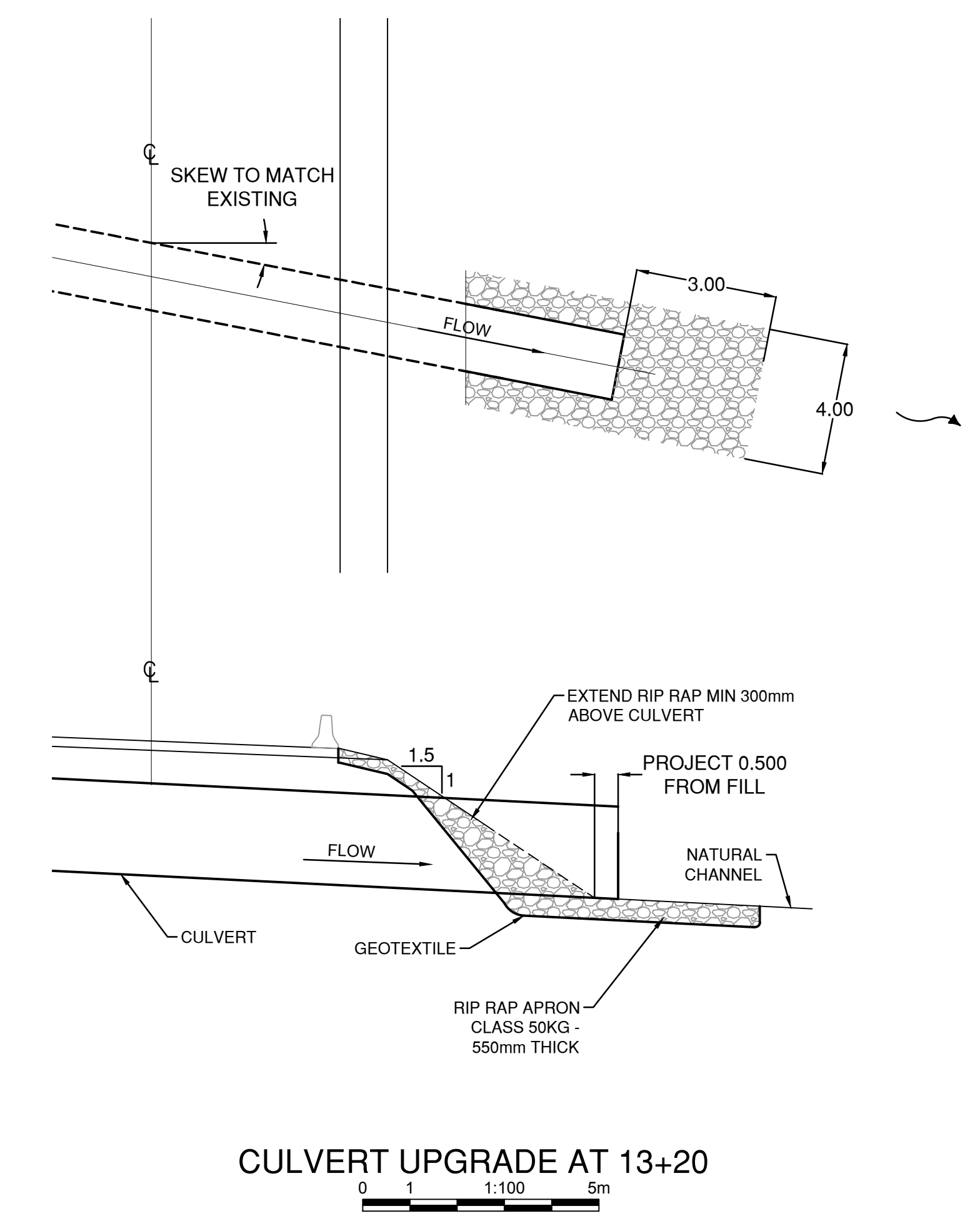
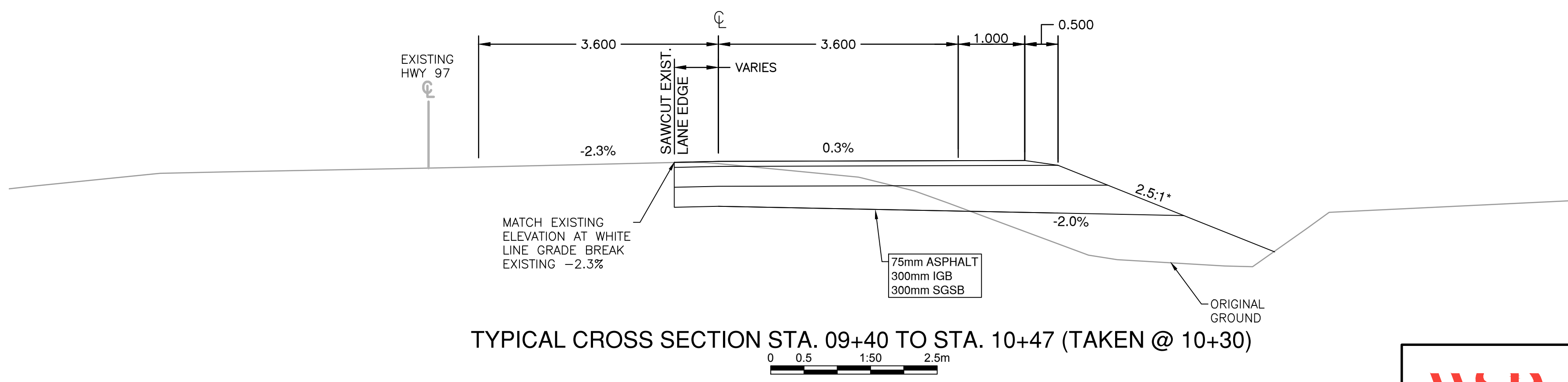
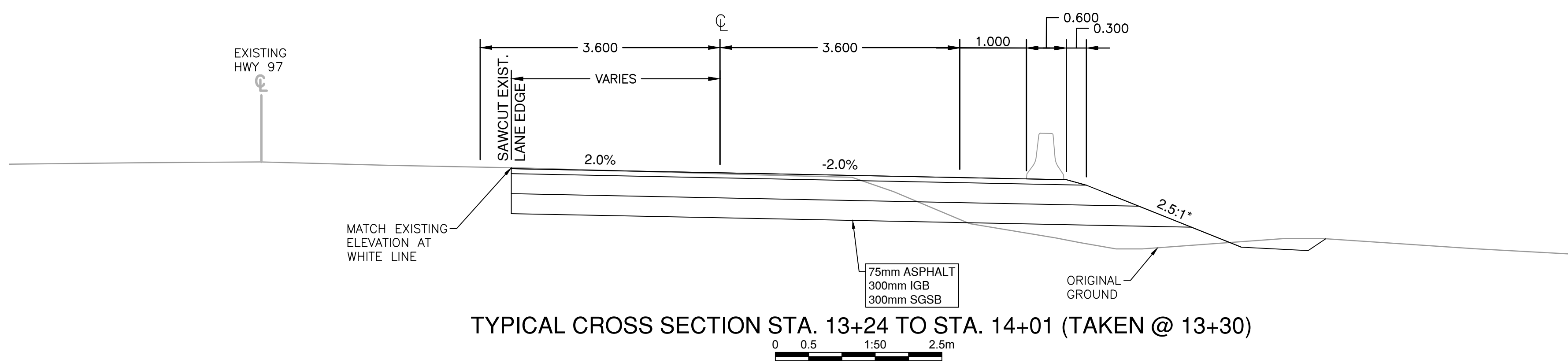
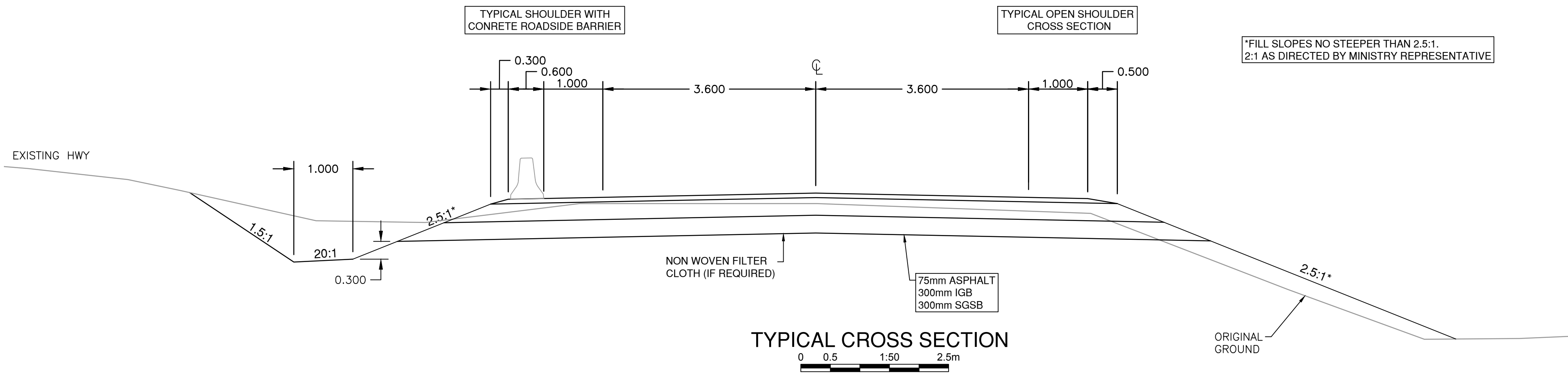

A:\171-06935-00 - Highway 97 - Commotion Creek\DWG\Trans\Drawing\Production\300_TypicalSections\NR-NINR-300.dwg Plotted August 22, 2017

		MINISTRY OF TRANSPORTATION AND INFRASTRUCTURE NORTHERN REGION HIGHWAY ENGINEERING AND GEOMATICS																																													
SCALE AS SHOWN		CAD FILENAME <u>NR-NIN-300</u> PLOT DATE <u>22/08/2017</u>																																													
<table border="1" style="width: 100%; border-collapse: collapse;"> <thead> <tr> <th>REV</th> <th>DATE</th> <th>REVISIONS</th> <th>NAME</th> </tr> </thead> <tbody> <tr><td> </td><td> </td><td> </td><td> </td></tr> <tr><td> </td><td> </td><td> </td><td> </td></tr> <tr><td> </td><td> </td><td> </td><td> </td></tr> <tr><td> </td><td> </td><td> </td><td> </td></tr> <tr><td> </td><td> </td><td> </td><td> </td></tr> <tr><td> </td><td> </td><td> </td><td> </td></tr> <tr><td> </td><td> </td><td> </td><td> </td></tr> <tr><td> </td><td> </td><td> </td><td> </td></tr> <tr><td> </td><td> </td><td> </td><td> </td></tr> <tr><td> </td><td> </td><td> </td><td> </td></tr> </tbody> </table>		REV	DATE	REVISIONS	NAME																																									TYPICAL SECTIONS HWY 97 DETOUR - COMMOTION CREEK BRIDGE	
REV	DATE	REVISIONS	NAME																																												
SENIOR DESIGNER _____ DATE <u>2017-07-05</u>		DESIGNED _____ RL DATE <u>2017-07-05</u> QUALITY CONTROL _____ DATE _____ QUALITY ASSURANCE _____ DATE _____ DRAWN _____ DEC DATE <u>2017-07-05</u>																																													
FILE NUMBER 171-06935-00		PROJECT NUMBER 35478																																													
REG R3		DRAWING NUMBER R3-308-301Dtr REV -																																													

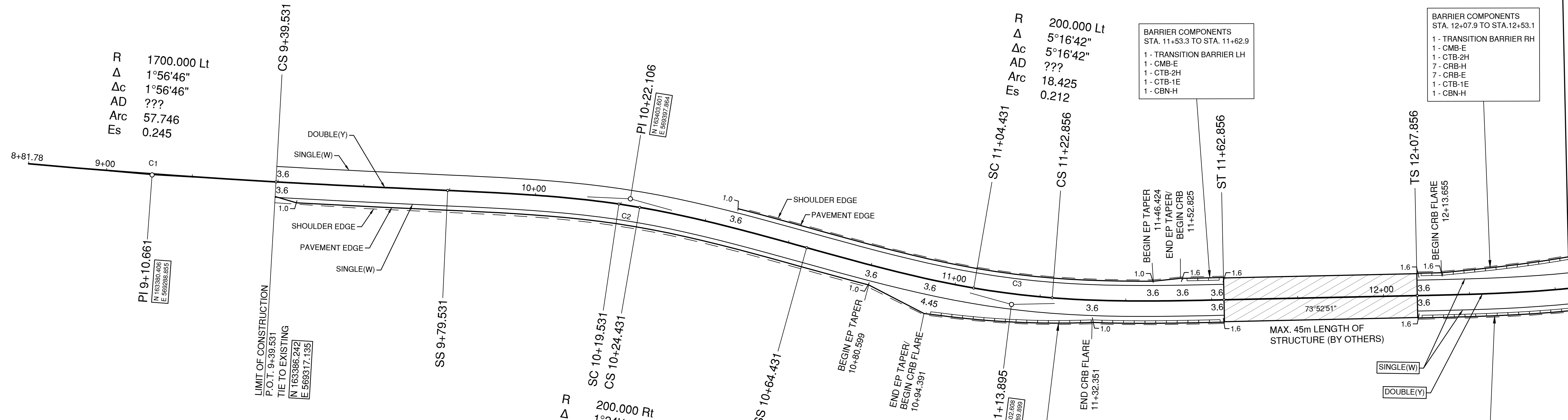
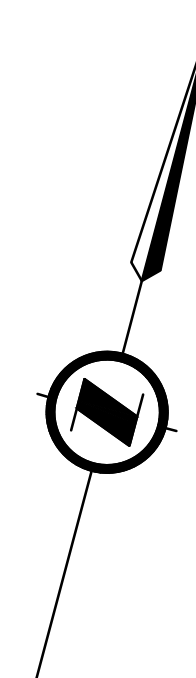

	START	CURVE 1	CURVE 2	CURVE 3	CURVE 4	CURVE 5	END
R		1700.000 LT	200.000 RT	200.000 LT	200.000 LT	200.000 RT	
Δ		0°40'26.64"	12°51'46.24"	16°44'15.25"	16°10'30.80"	16°10'30.80"	
Δ c		0°00'00.00"	1°24'13.28"	5°16'42.29"	4°42'57.84"	4°42'57.84"	
A.D.1		13.334	42.576	49.464	48.461	48.461	
A.D.2		26.667	42.576	49.464	48.461	48.461	
ARC		0.000	4.900	18.425	16.462	16.462	
Ext		0.046	1.602	2.489	2.346	2.346	
e	N/A	N/A	N/A	N/A	N/A	N/A	N/A
Ls1		40.000	40.000	40.000	40.000	40.000	
Os1		0°40'26.64"	5°43'46.48"	5°43'46.48"	5°43'46.48"	5°43'46.48"	
Ls2			40.000	40.000	40.000	40.000	
Os2			5°43'46.48"	5°43'46.48"	5°43'46.48"	5°43'46.48"	
PI	9+39.531	9+52.864	10+22.106	11+13.895	12+56.316	13+52.779	14+00.78
N.	163386.242	163388.916	163403.601	163402.608	163442.290	163494.072	163507.527
E.	569317.134	569330.197	569397.864	569489.899	569627.205	569709.134	569755.690

DESIGN SPEED 60 km/h



SCALE 0 5 1:500 25m

CAD FILENAME NR-NNN-400
PLOT DATE 22/08/2017



MINISTRY OF TRANSPORTATION AND INFRASTRUCTURE
NORTHERN REGION
HIGHWAY ENGINEERING AND GEOMATICS

GEOMETRICS AND LANING

HWY 97 DETOUR - COMMOTION CREEK BRIDGE

REV	DATE	REVISIONS	NAME

DESIGNED _____ RL DATE 2017-07-05	QUALITY CONTROL _____ DATE _____
QUALITY ASSURANCE _____ DATE _____	DRAWN _____ DEC DATE 2017-07-05
SENIOR DESIGNER _____	DATE 2017-07-05
FILE NUMBER 171-06935-00	PROJECT NUMBER 35478
REG R3	DRAWING NUMBER R3-308-401Dtr
REV -	REV -

A:\171-06935-00 - Highway 97 - Commotion Creek\DWG\Drawings\Production\400_Geometrics\171-06935-00.dwg Plotted August 22, 2017

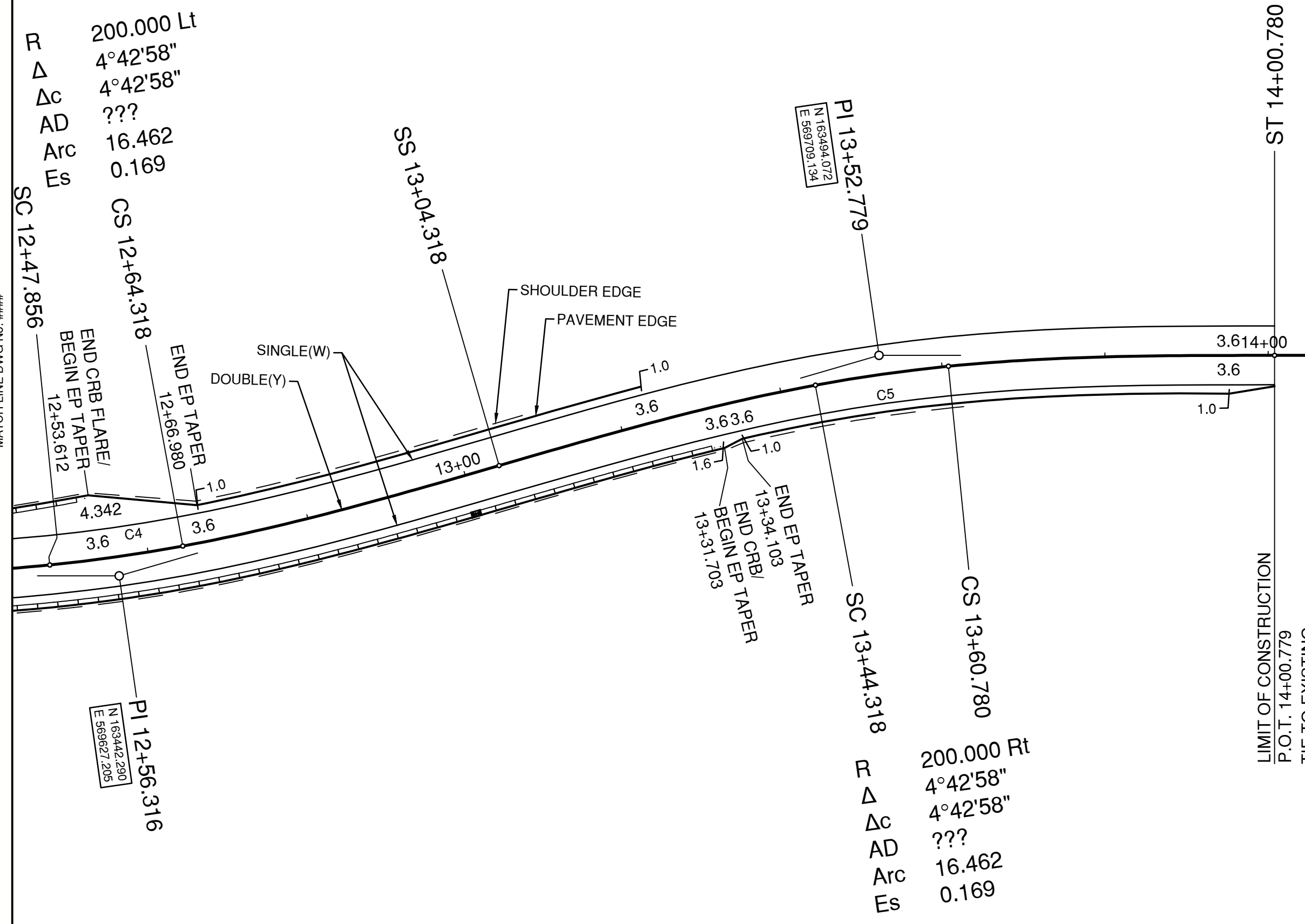
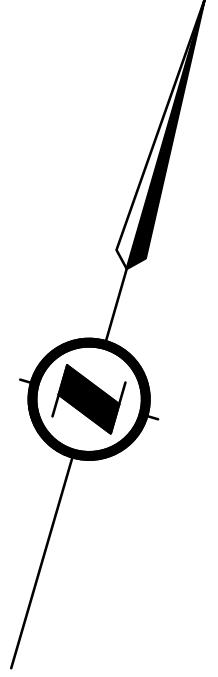

R 200.000 Rt
 Δc 4°42'58"
 AD ???
 Arc 16.462
 Es 0.169

LIMIT OF CONSTRUCTION
 P.O.T. 14+00.779
 TIE TO EXISTING
 N 163507.526
 E 595755.666

MATCH LINE DWG No: ###

Plotted August 22, 2017

A:\171-06935-00 - Highway 37 - Commotion Creek\DWG\Trans\Drawing\Production\400_Geometric\Laning\NR-NNN-400.dwg

DESIGN SPEED 60 km/h

				MINISTRY OF TRANSPORTATION AND INFRASTRUCTURE NORTHERN REGION HIGHWAY ENGINEERING AND GEOMATICS																																											
SCALE 0 5 1:500 25m		CAD FILENAME NR-NNN-400 PLOT DATE 22/08/2017		GEOMETRICS AND LANING HWY 97 DETOUR - COMMOTION CREEK BRIDGE																																											
<table border="1"> <thead> <tr> <th>REV</th> <th>DATE</th> <th>REVISIONS</th> <th>NAME</th> </tr> </thead> <tbody> <tr><td> </td><td> </td><td> </td><td> </td></tr> <tr><td> </td><td> </td><td> </td><td> </td></tr> <tr><td> </td><td> </td><td> </td><td> </td></tr> <tr><td> </td><td> </td><td> </td><td> </td></tr> <tr><td> </td><td> </td><td> </td><td> </td></tr> <tr><td> </td><td> </td><td> </td><td> </td></tr> <tr><td> </td><td> </td><td> </td><td> </td></tr> <tr><td> </td><td> </td><td> </td><td> </td></tr> <tr><td> </td><td> </td><td> </td><td> </td></tr> <tr><td> </td><td> </td><td> </td><td> </td></tr> </tbody> </table>		REV	DATE			REVISIONS	NAME																																								
REV	DATE	REVISIONS	NAME																																												
FILE NUMBER 171-06935-00		PROJECT NUMBER 35478		REG R3 DRAWING NUMBER R3-308-402Dtr REV -																																											