



Ministry of
Transportation
and Infrastructure

PROJECT NO. 38199-0000

CROSS SECTIONS

HIGHWAY 16

GUEST ROAD AND SHALLOW BAY ROAD INTERSECTIONS

FOR INFORMATION ONLY MARCH 03, 2023

DRAFT

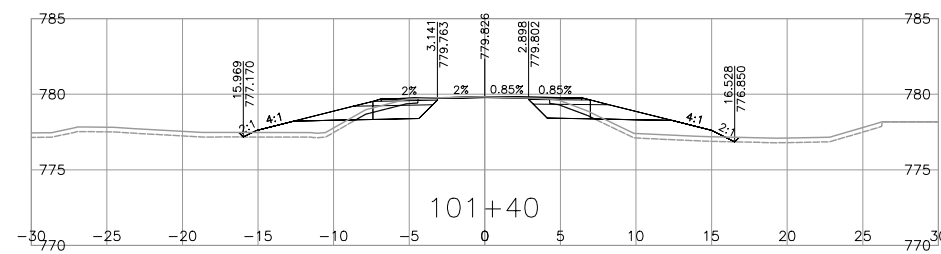
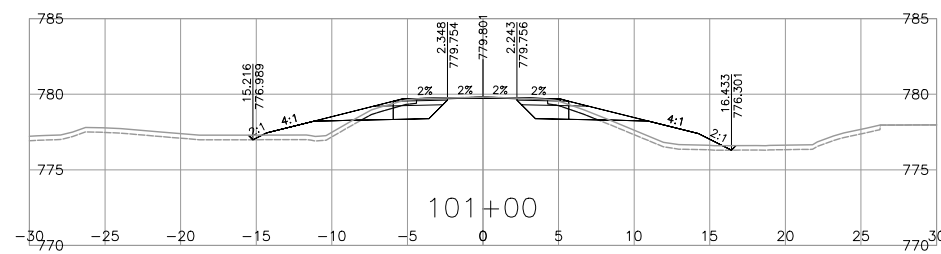
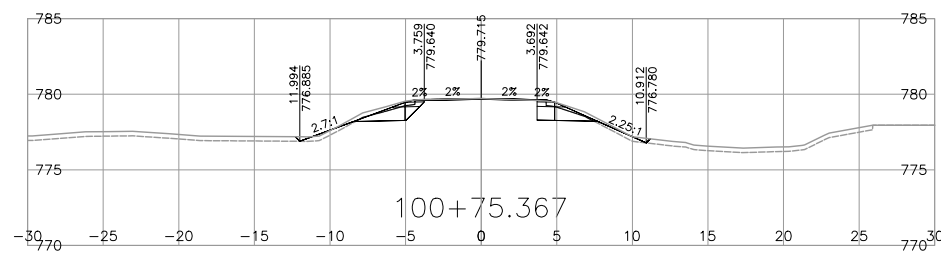
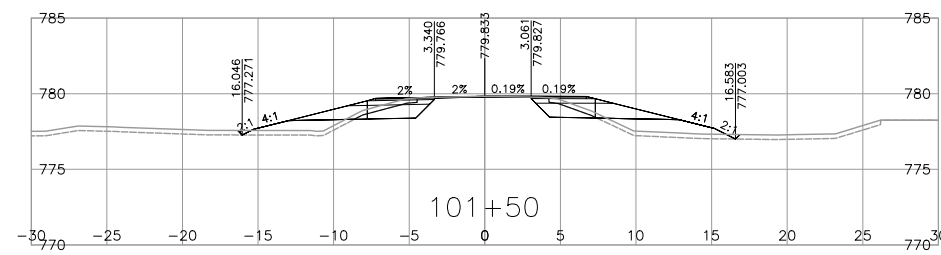
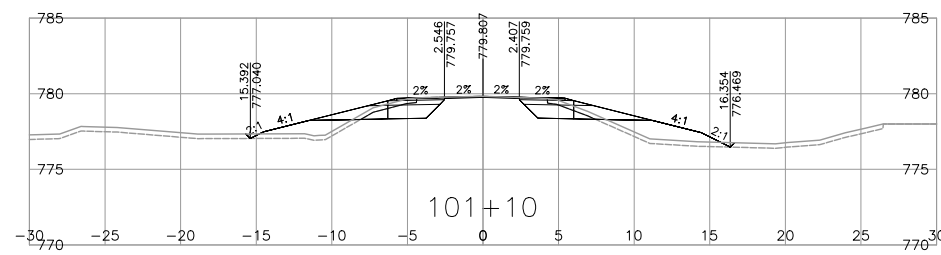
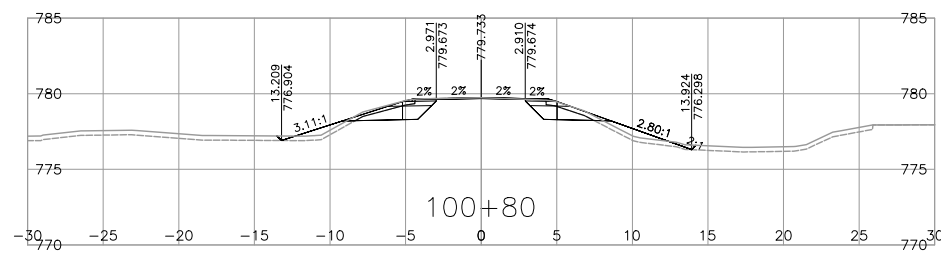
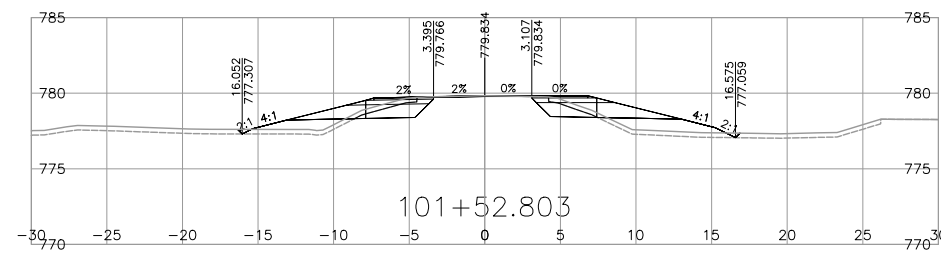
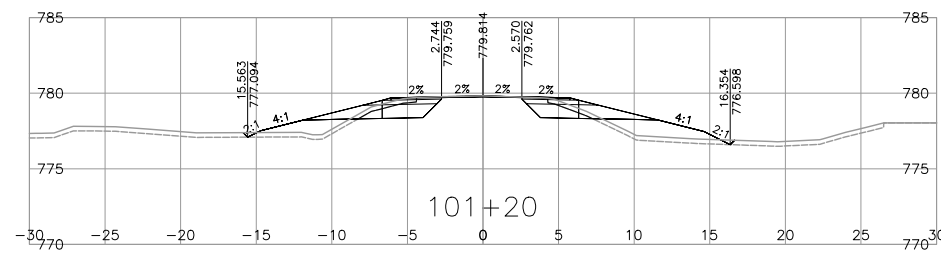
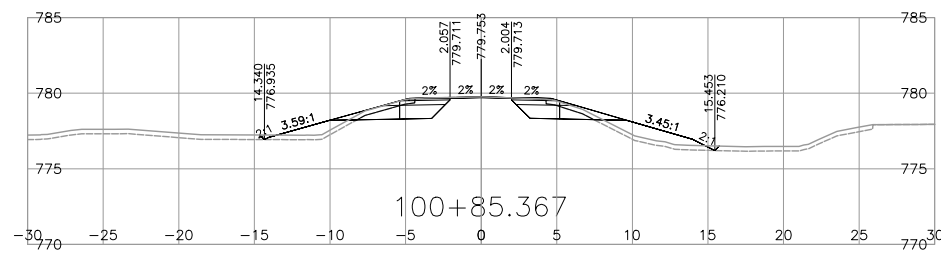
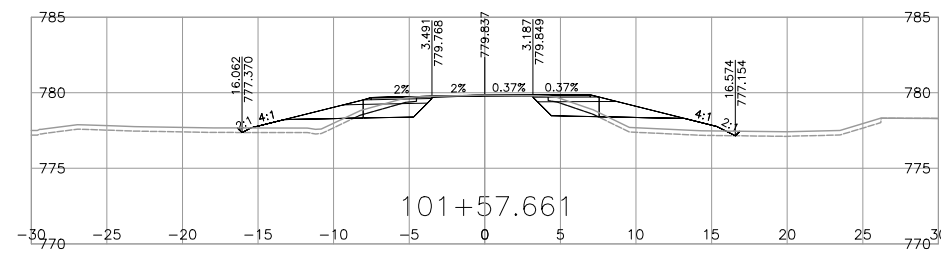
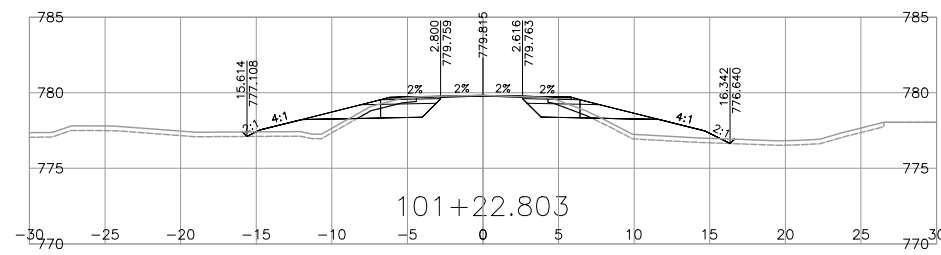
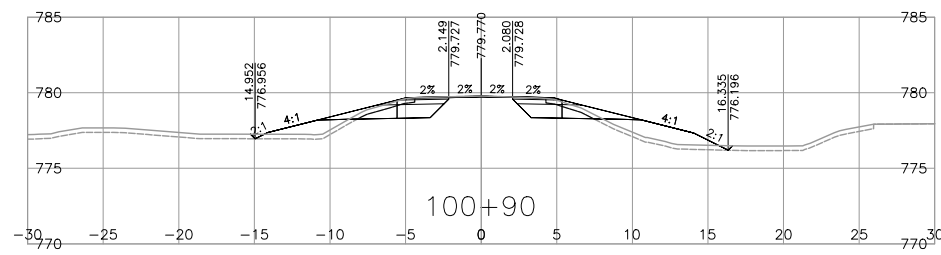
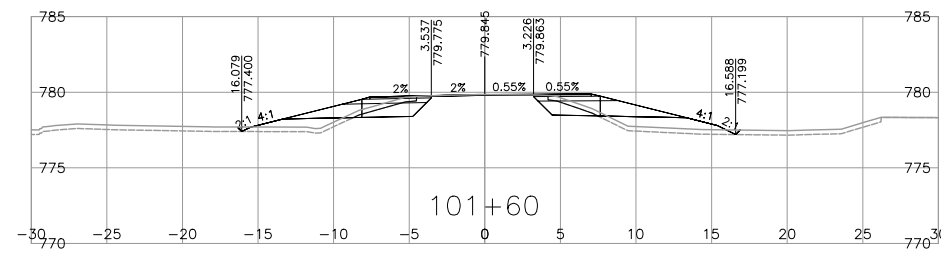
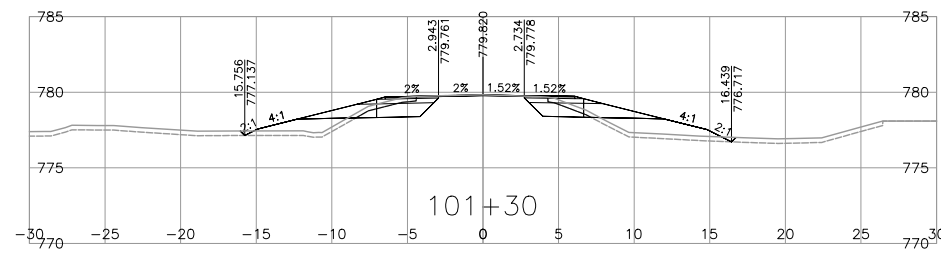
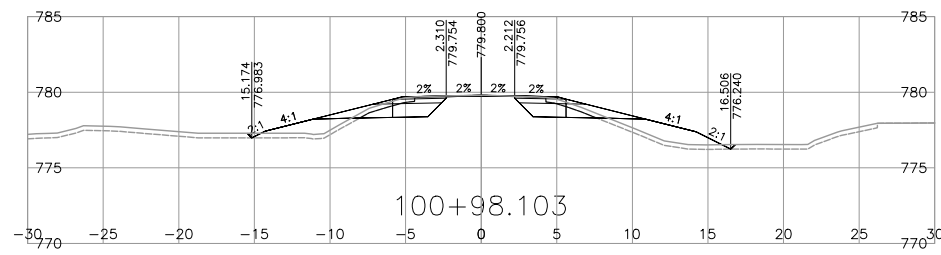

NOTE: STRIPPING REMOVAL APPLIES ONLY TO THE AREA BETWEEN SLOPE STAKE LINES (TOES & TOP OF CUT) OF PROPOSED ROADWAY TEMPLATE

FOR REFERENCE ONLY

DRAFT

FOR INFORMATION ONLY MARCH 03, 2023

R.F. BINNIE & ASSOCIATES LTD.
101 - 1577 7th Avenue,
Prince George, BC V2L 3P5
TEL 250 561 7274
BINNIE.com

MINISTRY OF TRANSPORTATION AND INFRASTRUCTURE
NORTHERN REGION
HIGHWAY ENGINEERING AND GEOMATICS

L100A1-LINE CROSS SECTIONS
HIGHWAY 16
GUEST ROAD AND SHALLOW BAY ROAD INTERSECTIONS

SCALE: 0 2 1:250 12m CAD FILENAME: 21-0125-1000XS-L100A1.DWG DATE: 2023-03-01 FILE NUMBER: 21-0125-00

REV	DATE	REVISIONS	SIGNATURE

R. Mankowske
ENGINEER OF RECORD
DATE 20230303

DESIGNED	_____	R.M.	DATE	MAR. 2023
QUALITY CONTROL	_____	K.T.	DATE	MAR. 2023
QUALITY ASSURANCE	_____	R.M.	DATE	MAR. 2023
DRAWN	_____	J.D.	DATE	MAR. 2023
PROJECT NUMBER	38199-0000	REG	3	DRAWING NUMBER
				L100A1-1XS

Mar. 1, 2023 - 11:24 AM P:\2021\21-0125-00 - CAD Files\CAD-Files\Binn\Drawings\Production\000_Design\Sections\1-0125-1000XS-L100A1

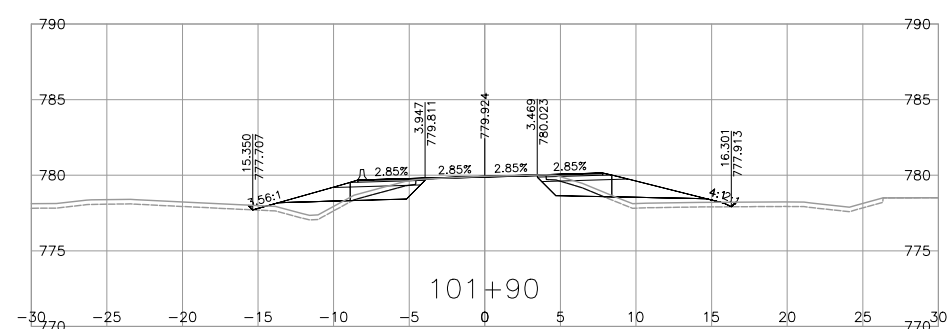
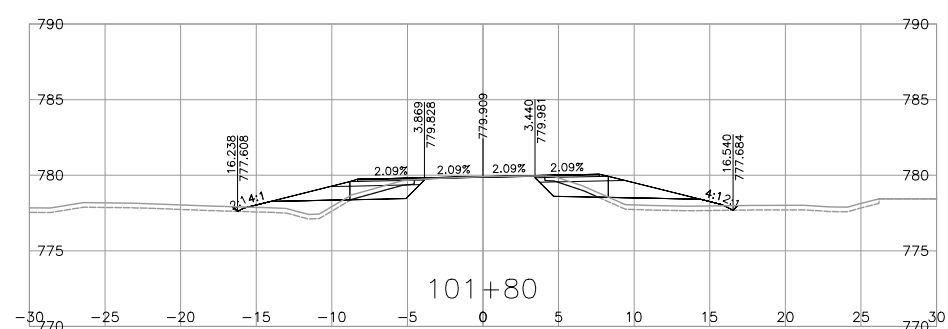
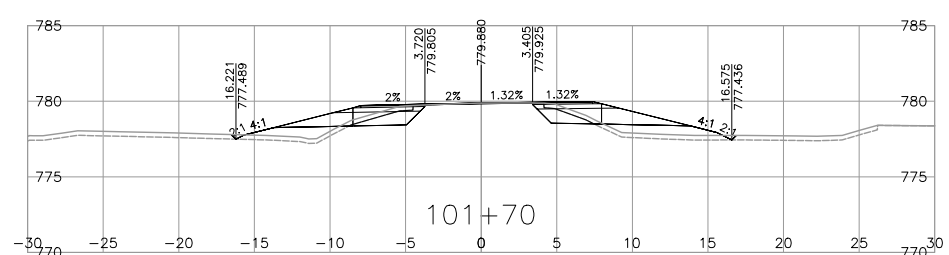
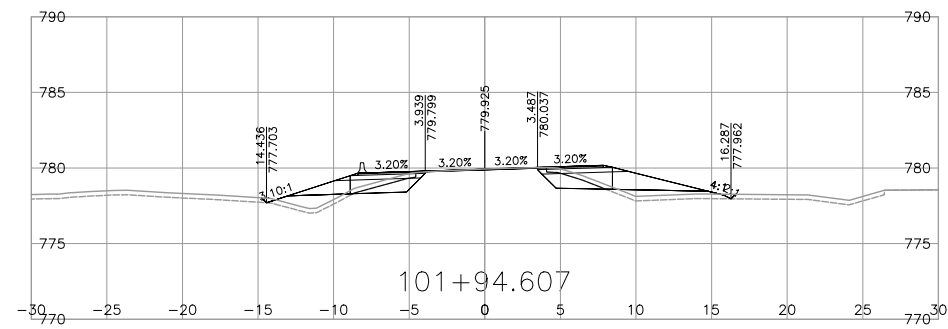
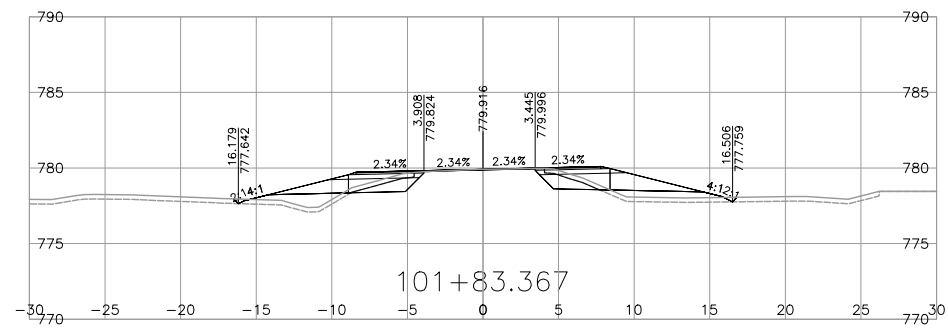
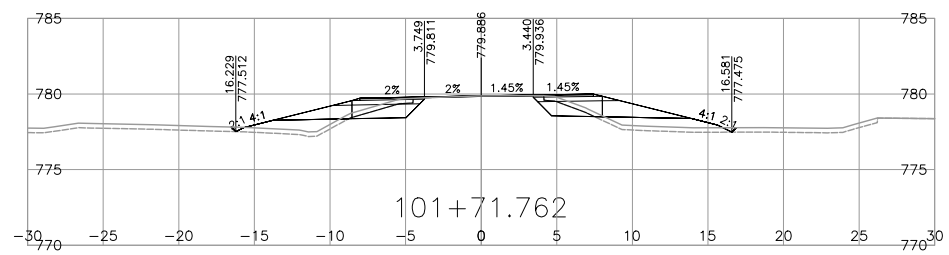
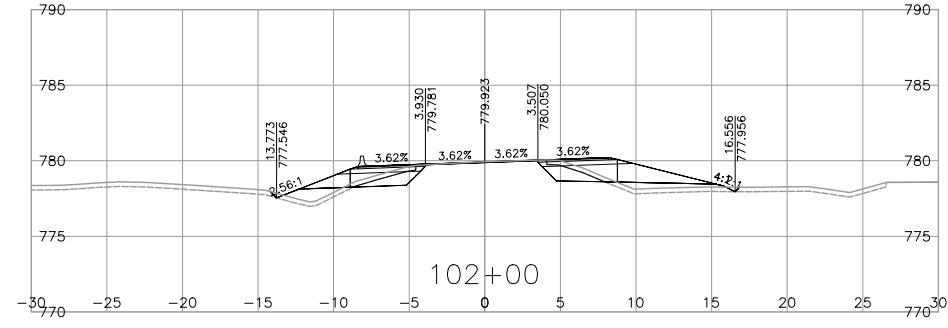
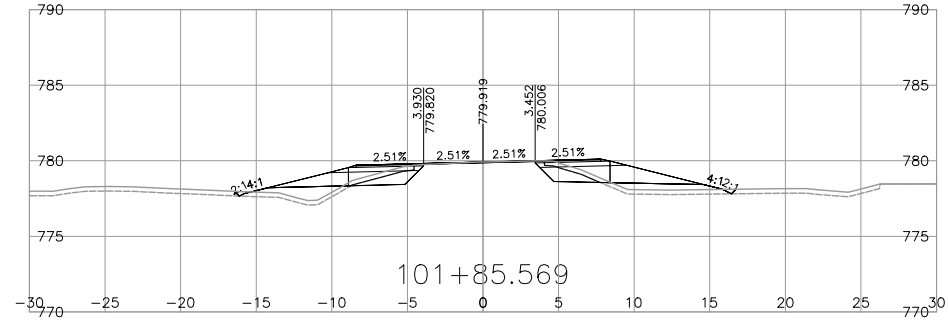
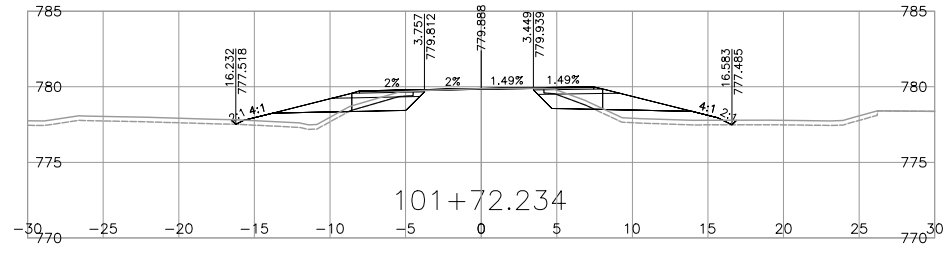
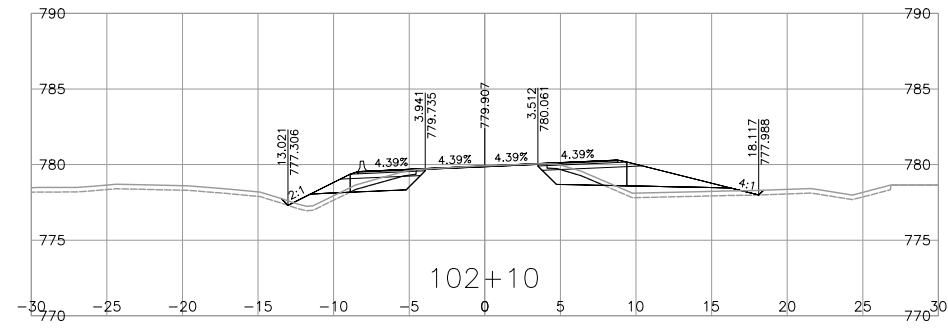
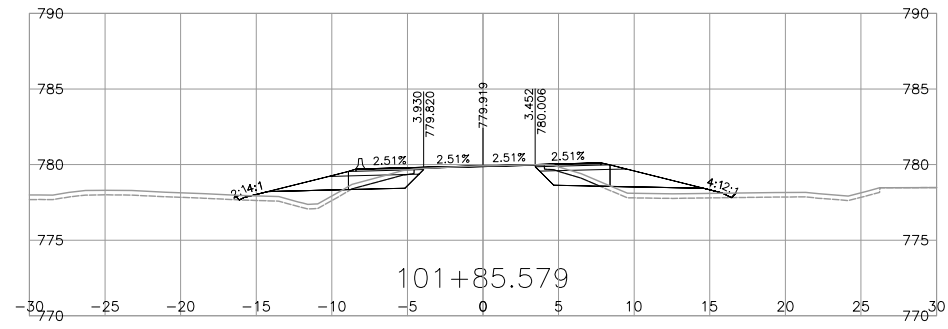
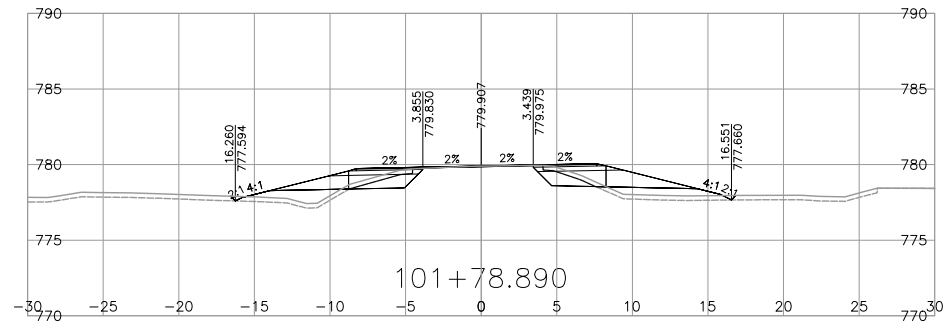

NOTE: STRIPPING REMOVAL APPLIES ONLY TO THE AREA BETWEEN SLOPE STAKE LINES (TOES & TOP OF CUT) OF PROPOSED ROADWAY TEMPLATE

FOR REFERENCE ONLY

DRAFT

FOR INFORMATION ONLY MARCH 03, 2023

BINNIE
The people behind your infrastructure.

R.F. BINNIE & ASSOCIATES LTD.
101 - 1577 7th Avenue,
Prince George, BC V2L 3P5
TEL 250 561 7274
BINNIE.com

BRITISH COLUMBIA

MINISTRY OF TRANSPORTATION AND INFRASTRUCTURE
NORTHERN REGION
HIGHWAY ENGINEERING AND GEOMATICS

L100A1-LINE CROSS SECTIONS
HIGHWAY 16
GUEST ROAD AND SHALLOW BAY ROAD INTERSECTIONS

SCALE

REV	DATE	REVISIONS	SIGNATURE

CAD FILENAME: 21-0125-1000XS-L100A1.DWG
DATE: 2023-03-01
FILE NUMBER: 21-0125-00

R. Mankowske
ENGINEER OF RECORD
DATE: 20230303

DESIGNED	_____	R.M.	DATE	MAR_2023
QUALITY CONTROL	_____	K.T.	DATE	MAR_2023
QUALITY ASSURANCE	_____	R.M.	DATE	MAR_2023
DRAWN	_____	J.D.	DATE	MAR_2023
PROJECT NUMBER	38199-0000	REG	3	DRAWING NUMBER
				-L100A1-2XS

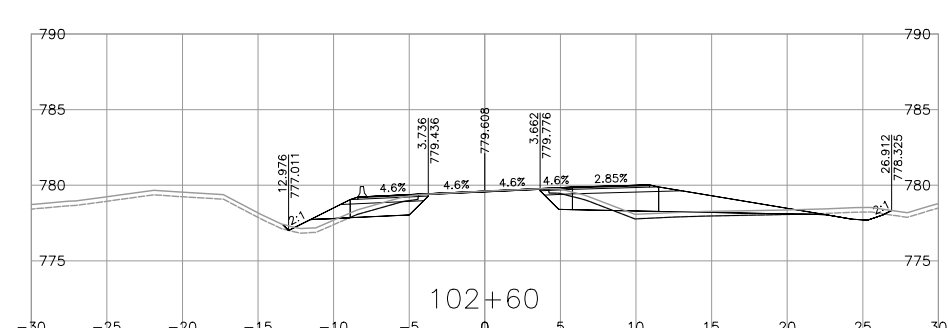
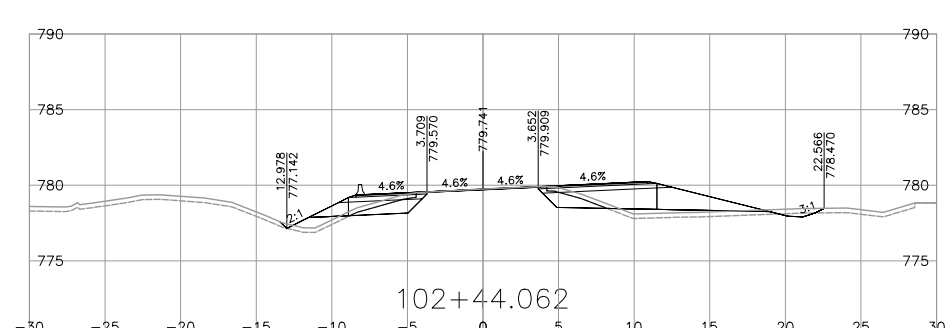
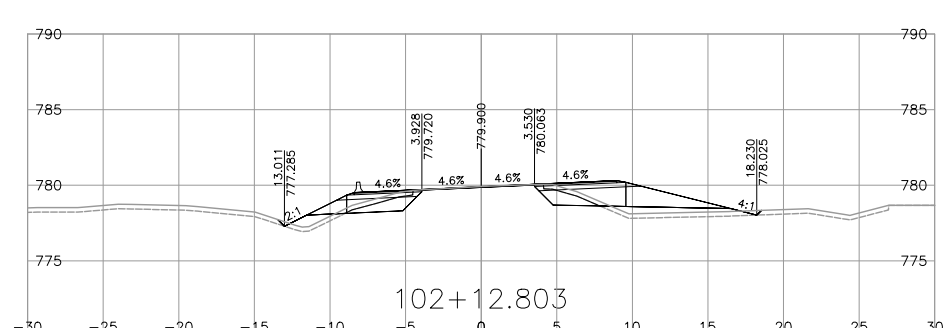
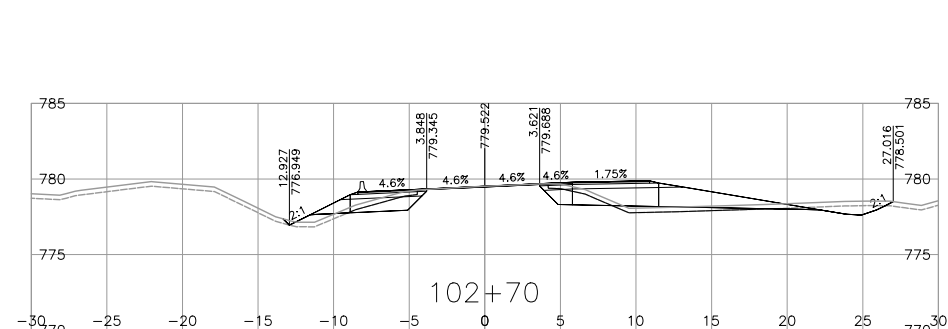
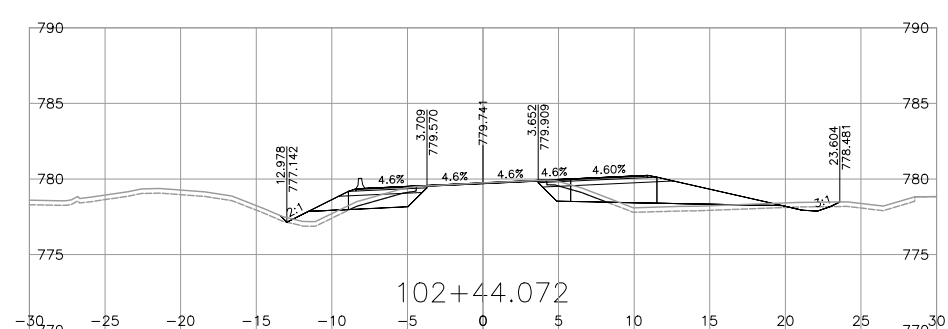
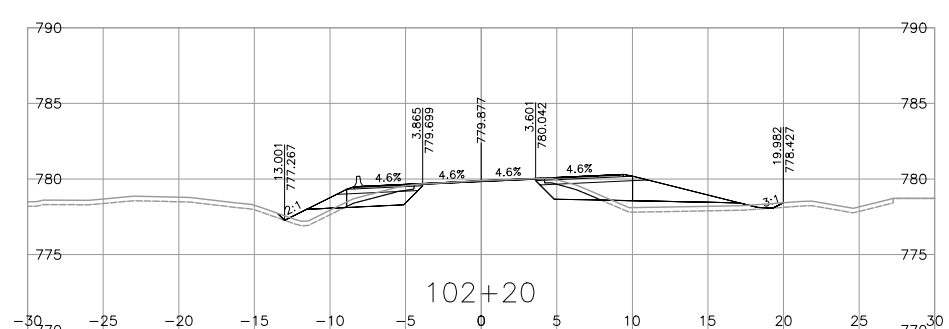
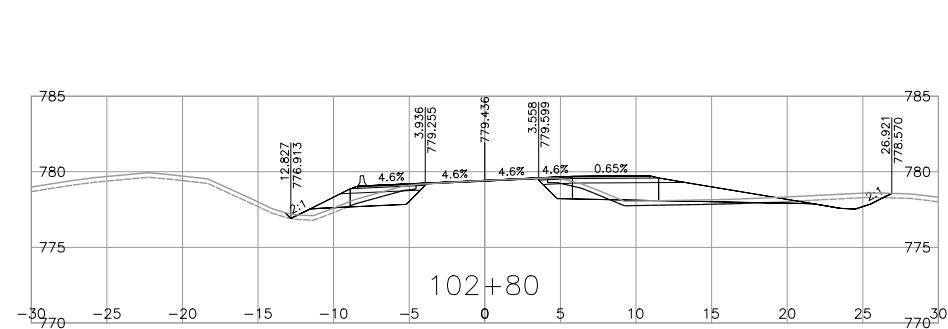
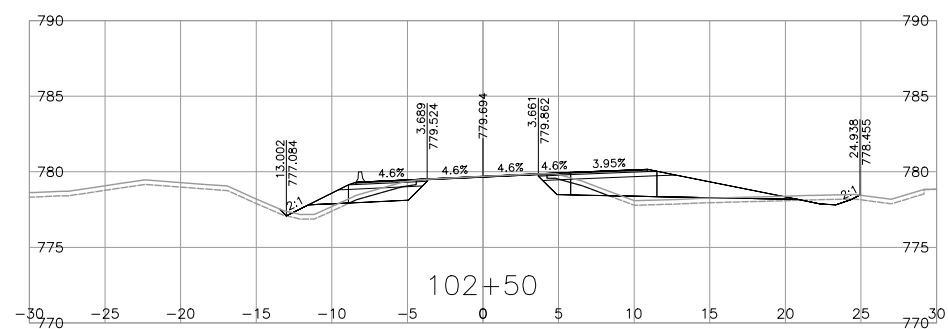
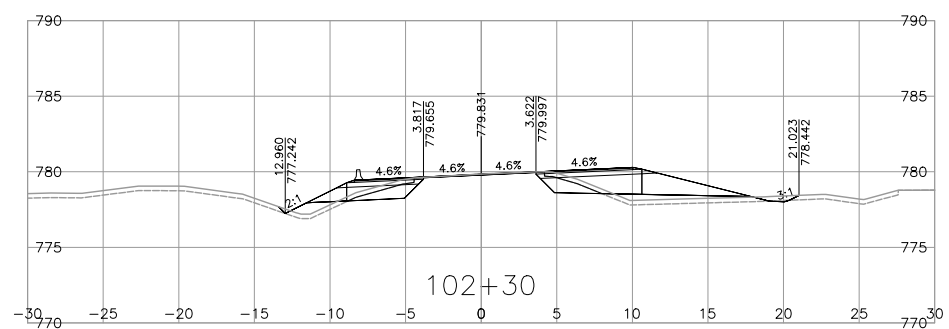
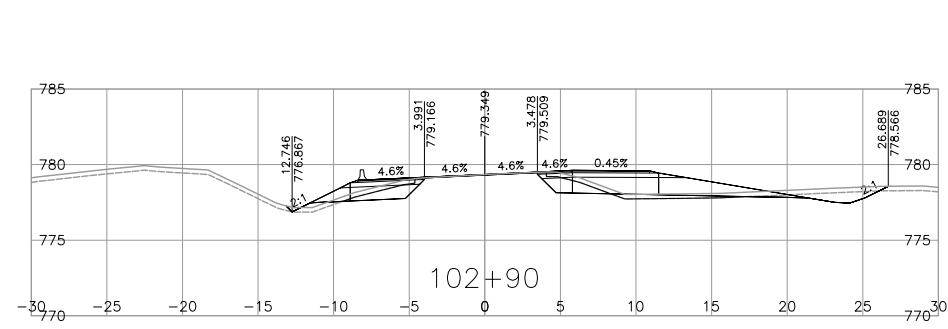
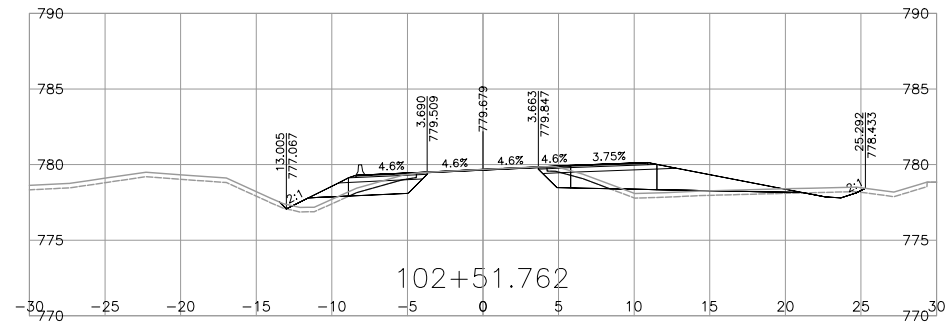
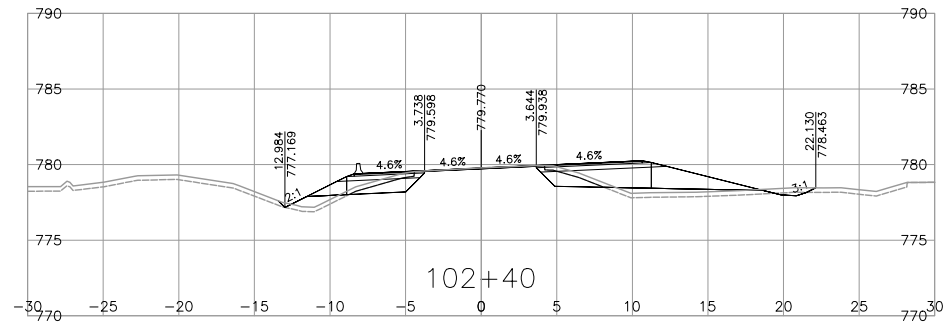

NOTE: STRIPPING REMOVAL APPLIES ONLY TO THE AREA BETWEEN SLOPE STAKE LINES (TOES & TOP OF CUT) OF PROPOSED ROADWAY TEMPLATE

FOR REFERENCE ONLY

DRAFT

FOR INFORMATION ONLY MARCH 03, 2023

BINNIE
The people behind your infrastructure.

R.F. BINNIE & ASSOCIATES LTD.
101 - 1577 7th Avenue,
Prince George, BC V2L 3P5
TEL 250 561 7274
BINNIE.com

BRITISH COLUMBIA
MINISTRY OF TRANSPORTATION AND INFRASTRUCTURE
NORTHERN REGION
HIGHWAY ENGINEERING AND GEOMATICS

L100A1-LINE CROSS SECTIONS
HIGHWAY 16
GUEST ROAD AND SHALLOW BAY ROAD INTERSECTIONS

SCALE

REV	DATE	REVISIONS	SIGNATURE

CAD FILENAME: 21-0125-1000XS-L100A1.DWG
DATE: 2023-03-01
FILE NUMBER: 21-0125-00

DESIGNED	_____	R.M.	DATE	MAR_2023
QUALITY CONTROL	_____	K.T.	DATE	MAR_2023
QUALITY ASSURANCE	_____	R.M.	DATE	MAR_2023
DRAWN	_____	J.D.	DATE	MAR_2023

R. Mankowske
ENGINEER OF RECORD
DATE 20230303

PROJECT NUMBER	38199-0000	REG	3	DRAWING NUMBER	-L100A1-3XS	REV	
----------------	------------	-----	---	----------------	-------------	-----	--

Mar. 1, 2023 - 11:24 AM P:\2021\21-0125-00 - CAD Files\CAD-Highway\Production\1000_Design\Sections\1-0125-1000XS-L100A1

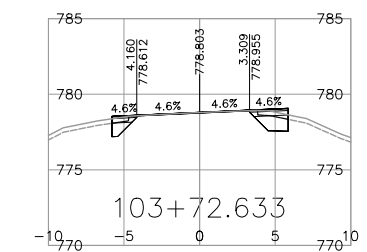
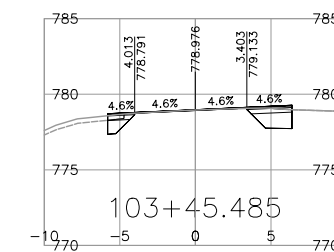
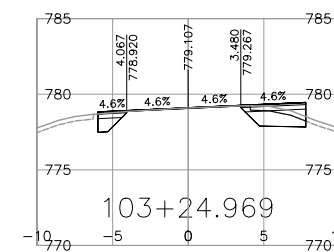
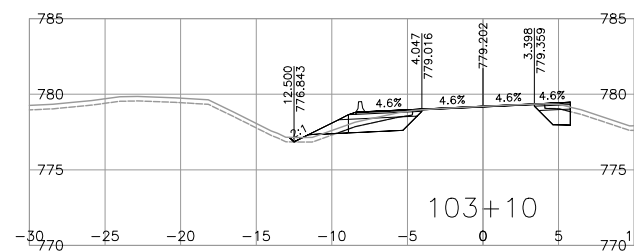
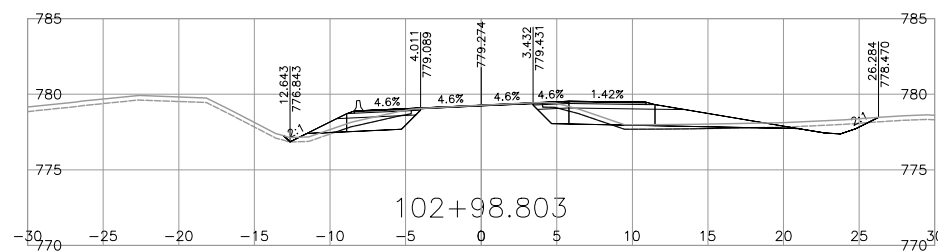
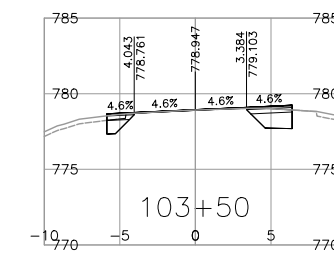
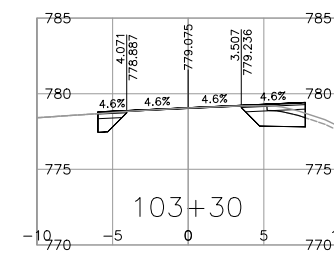
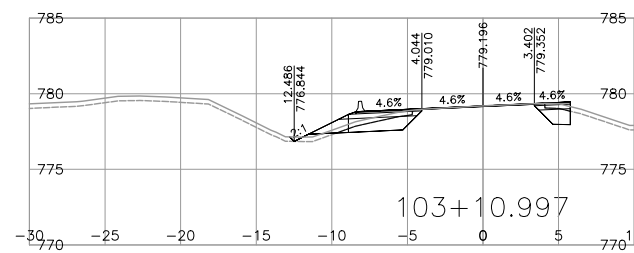
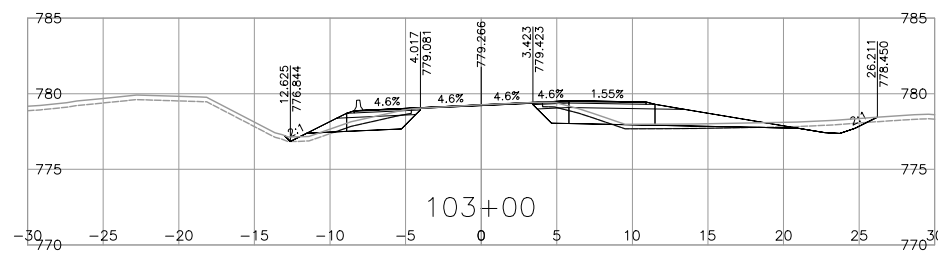
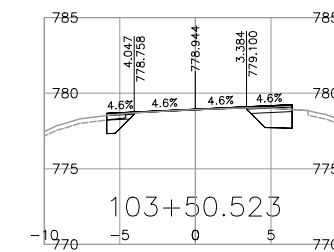
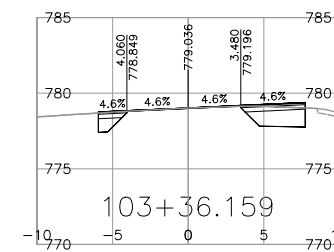
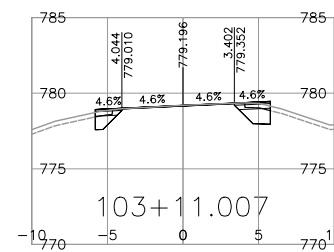
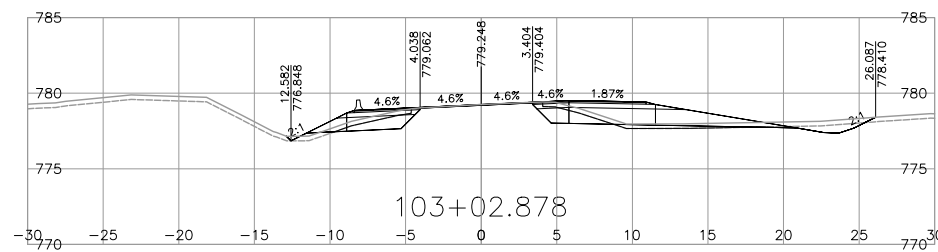
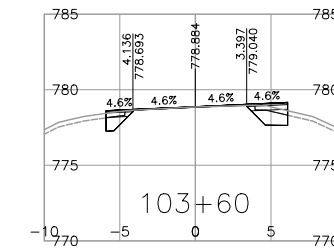
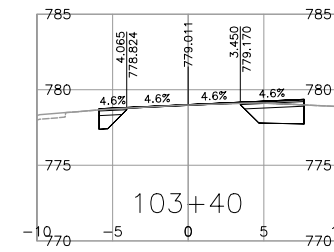
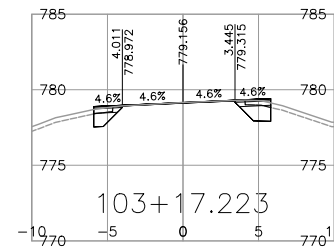
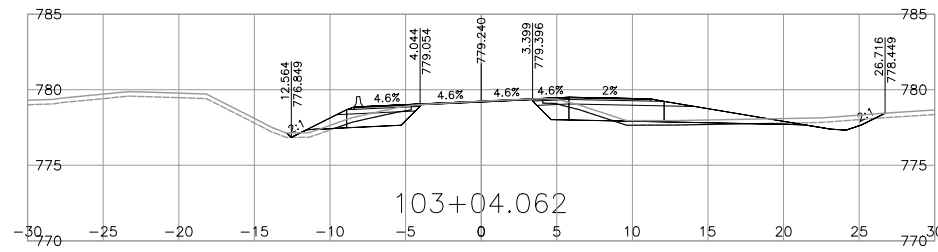
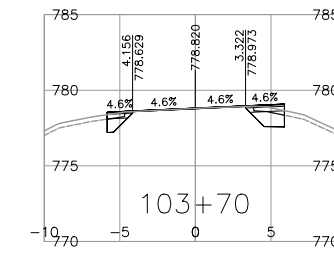
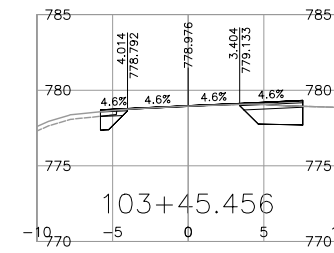
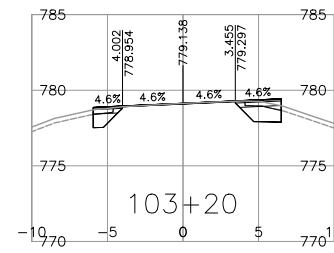
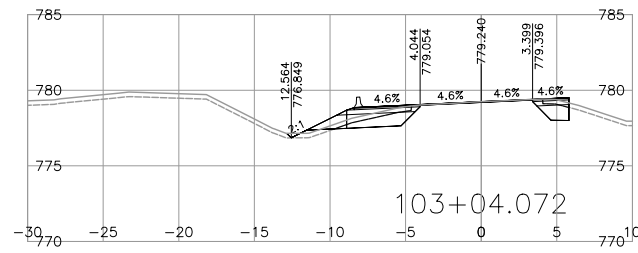

NOTE: STRIPPING REMOVAL APPLIES ONLY TO THE AREA BETWEEN SLOPE STAKE LINES (TOES & TOP OF CUT) OF PROPOSED ROADWAY TEMPLATE

FOR REFERENCE ONLY

DRAFT

FOR INFORMATION ONLY MARCH 03, 2023

BINNIE
The people behind your infrastructure.

R.F. BINNIE & ASSOCIATES LTD.
101 - 1577 7th Avenue,
Prince George, BC V2L 3P5
TEL 250 561 7274
BINNIE.com

BRITISH COLUMBIA

MINISTRY OF TRANSPORTATION AND INFRASTRUCTURE
NORTHERN REGION
HIGHWAY ENGINEERING AND GEOMATICS

SCALE: 0 2 1:250 12m

CAD FILENAME: 21-0125-1000XS-1-100A1.DWG
DATE: 2023-03-01
FILE NUMBER: 21-0125-00

REV	DATE	REVISIONS	SIGNATURE

L100A1-LINE CROSS SECTIONS
HIGHWAY 16
GUEST ROAD AND SHALLOW BAY ROAD INTERSECTIONS

DESIGNED: _____ R.M. DATE: MAR. 2023
QUALITY CONTROL: _____ K.T. DATE: MAR. 2023
QUALITY ASSURANCE: _____ R.M. DATE: MAR. 2023
DRAWN: _____ J.D. DATE: MAR. 2023

PROJECT NUMBER: 38199-0000
REG: 3

ENGINEER OF RECORD: R. Mankowske
DATE: 20230303

DRAWING NUMBER: -L100A1-4XS
REV: _____

Mar. 1, 2023 - 11:24 AM P:\2021\21-0125-00 - CAD Files\CAD-Highway\Production\1000 - Design\Sections\1-0125-1000XS-1-100A1

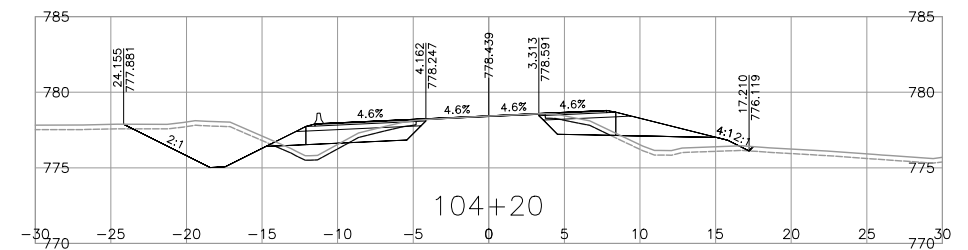
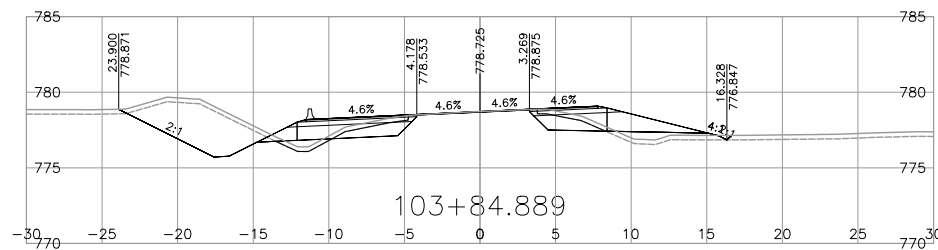
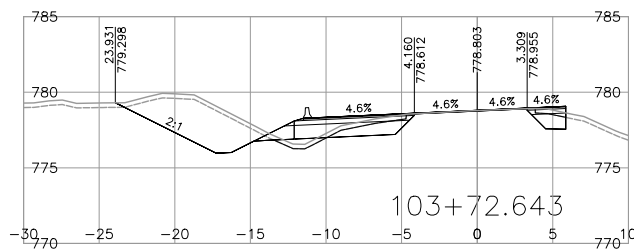
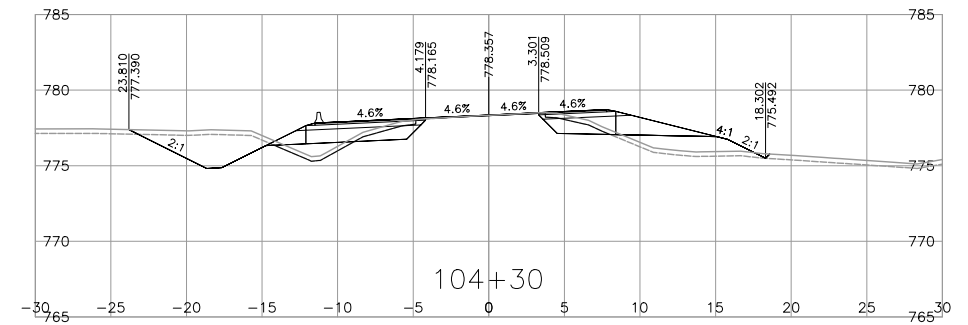
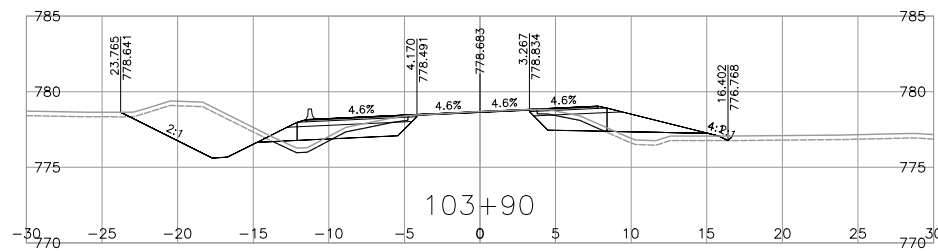
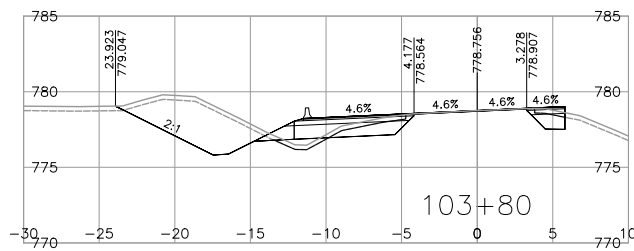
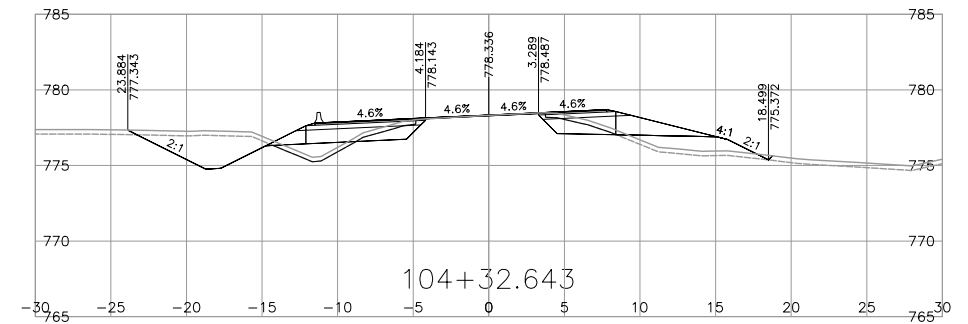
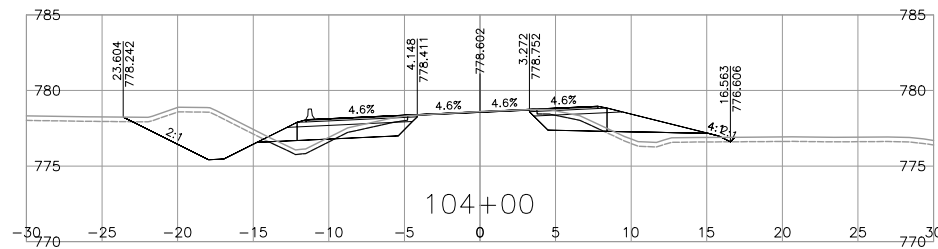
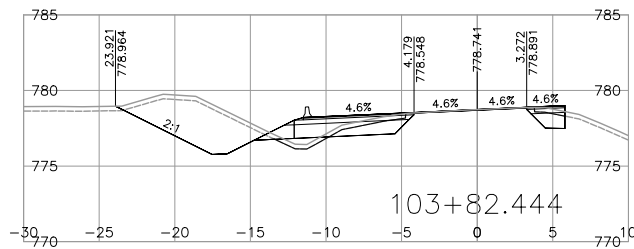
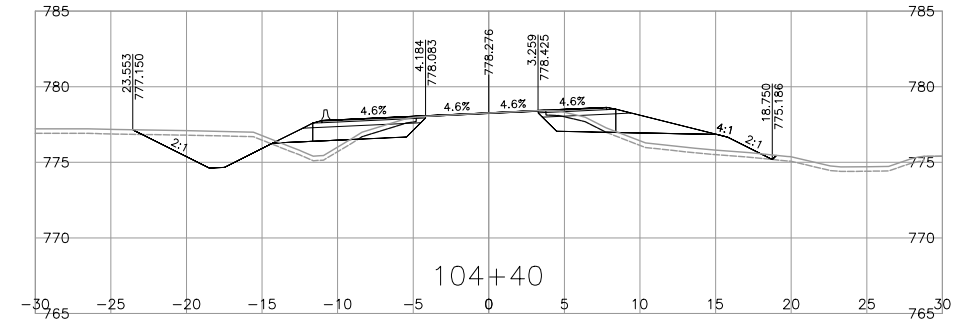
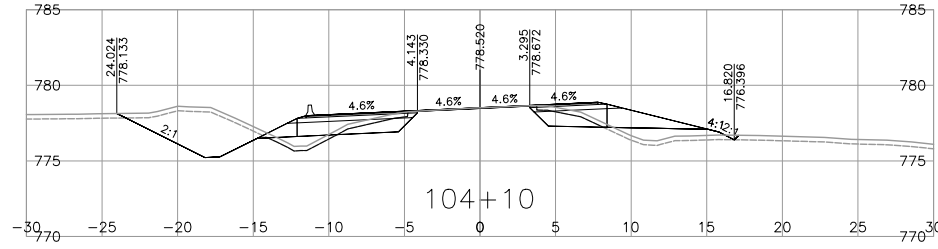
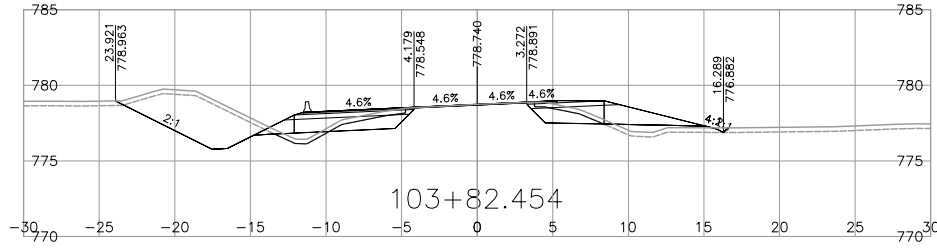

NOTE: STRIPPING REMOVAL APPLIES ONLY TO THE AREA BETWEEN SLOPE STAKE LINES (TOES & TOP OF CUT) OF PROPOSED ROADWAY TEMPLATE

FOR REFERENCE ONLY

DRAFT

FOR INFORMATION ONLY MARCH 03, 2023

BINNIE
The people behind your infrastructure.

R.F. BINNIE & ASSOCIATES LTD.
101 - 1577 7th Avenue,
Prince George, BC V2L 3P5
TEL 250 561 7274
BINNIE.com

BRITISH COLUMBIA
MINISTRY OF TRANSPORTATION AND INFRASTRUCTURE
NORTHERN REGION
HIGHWAY ENGINEERING AND GEOMATICS

SCALE 0 2 1:250 12m

CAD FILENAME 21-0125-1000XS-1-100A1.DWG
DATE 2023-03-01
FILE NUMBER 21-0125-00

REV	DATE	REVISIONS	SIGNATURE

L100A1-LINE CROSS SECTIONS
HIGHWAY 16
GUEST ROAD AND SHALLOW BAY ROAD INTERSECTIONS

DESIGNED	R.M.	DATE	MAR_2023
QUALITY CONTROL	K.T.	DATE	MAR_2023
QUALITY ASSURANCE	R.M.	DATE	MAR_2023
DRAWN	J.D.	DATE	MAR_2023
PROJECT NUMBER	38199-0000	REG	3
ENGINEER OF RECORD	R. Mankowske	DRAWING NUMBER	-L100A1-5XS
DATE	20230303	REV	

Mar 1, 2023 - 11:24 AM P:\2021\21-0125-00 - CAD Files\CAD\H1\Drawings\Production\1000_Design\Sections\H1-0125-1000XS-1-100A1

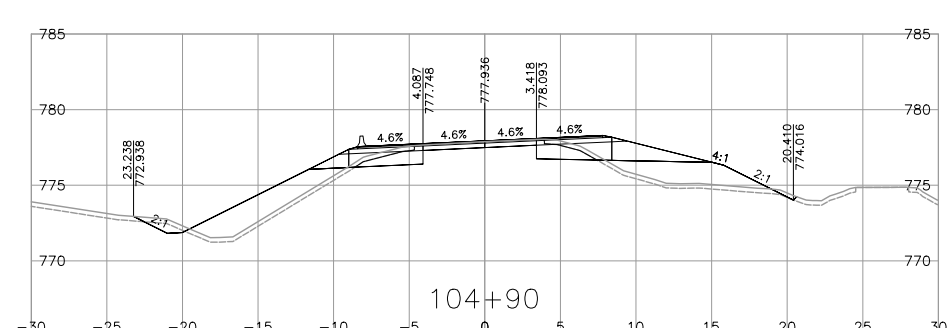
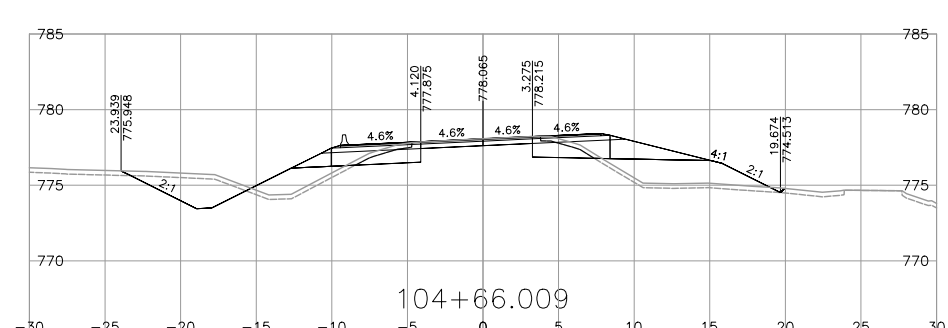
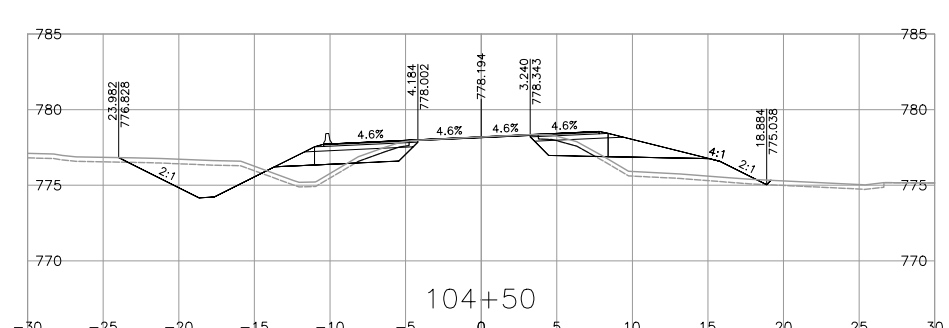
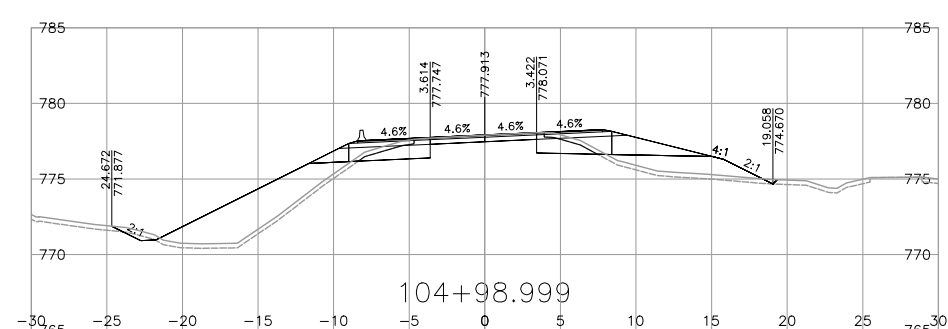
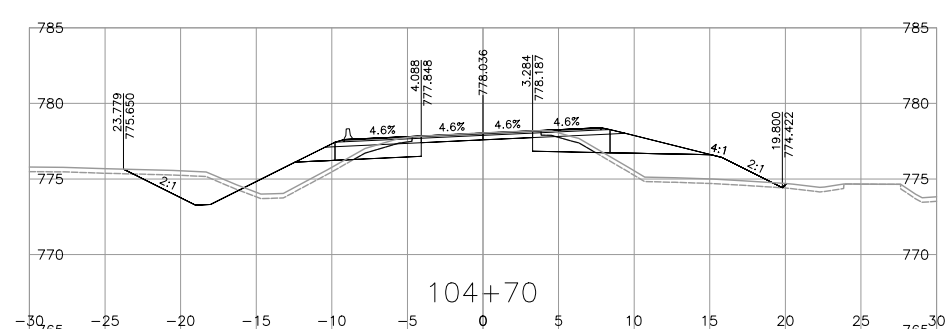
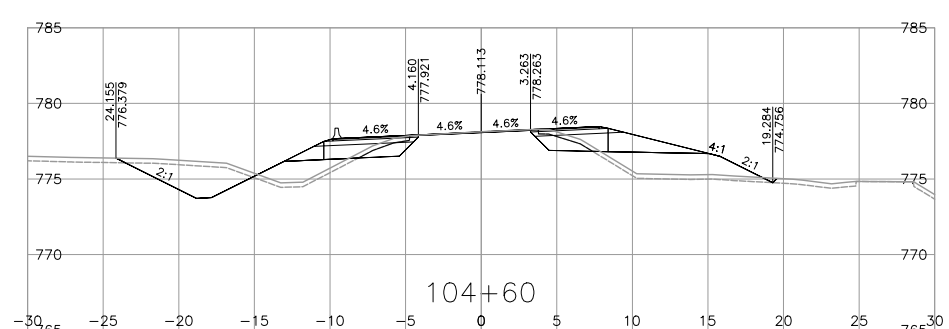
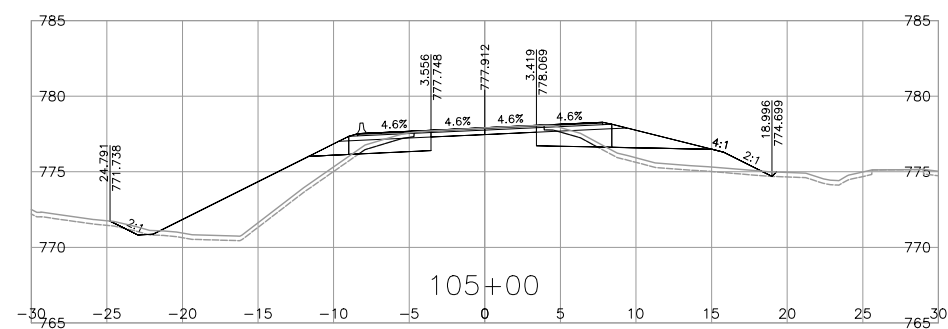
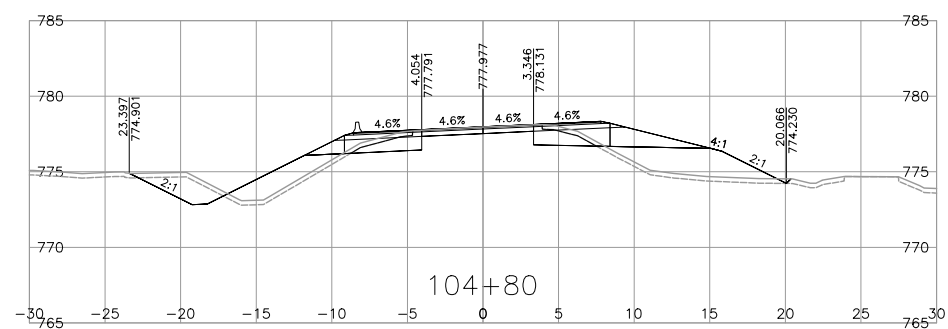
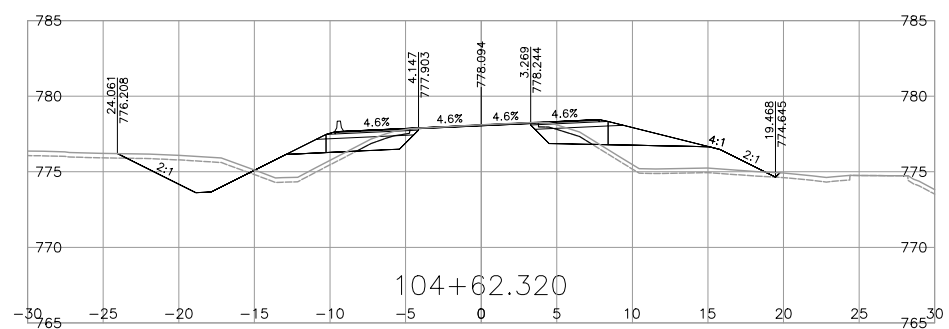
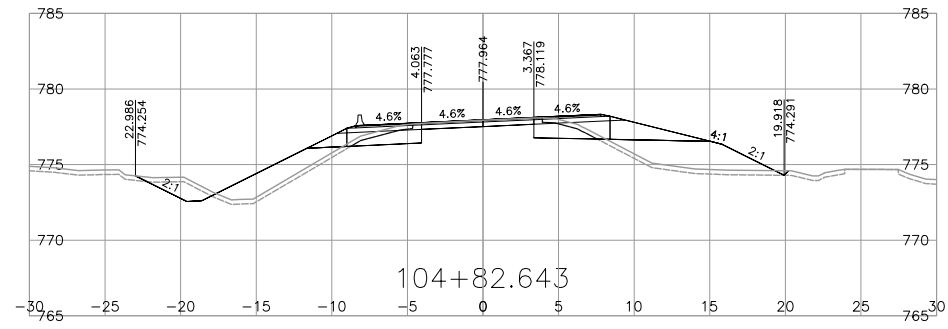
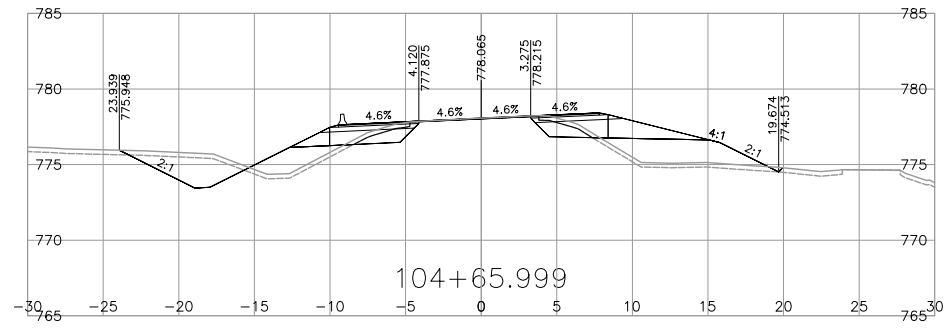

NOTE: STRIPPING REMOVAL APPLIES ONLY TO THE AREA BETWEEN SLOPE STAKE LINES (TOES & TOP OF CUT) OF PROPOSED ROADWAY TEMPLATE

FOR REFERENCE ONLY

DRAFT

FOR INFORMATION ONLY MARCH 03, 2023

BINNIE
The people behind your infrastructure.

R.F. BINNIE & ASSOCIATES LTD.
101 - 1577 7th Avenue,
Prince George, BC V2L 3P5
TEL 250 561 7274
BINNIE.com

BRITISH COLUMBIA
MINISTRY OF TRANSPORTATION AND INFRASTRUCTURE
NORTHERN REGION
HIGHWAY ENGINEERING AND GEOMATICS

L100A1-LINE CROSS SECTIONS
HIGHWAY 16
GUEST ROAD AND SHALLOW BAY ROAD INTERSECTIONS

SCALE

CAD FILENAME: 21-0125-1000XS-L100A1.DWG
DATE: 2023-03-01
FILE NUMBER: 21-0125-00

REV	DATE	REVISIONS	SIGNATURE

DESIGNED	_____	R.M.	DATE	MAR_2023
QUALITY CONTROL	_____	K.T.	DATE	MAR_2023
QUALITY ASSURANCE	_____	R.M.	DATE	MAR_2023
DRAWN	_____	J.D.	DATE	MAR_2023
PROJECT NUMBER	38199-0000	REG	3	DRAWING NUMBER
		ENGINEER OF RECORD		-L100A1-6XS
		DATE 20230303		

Mar 1, 2023 - 11:24 AM P:\2021\21-0125-00 - CAD Files\CAD\H1\CrossR11\DrawingProduction\000_Design\Sections\0125-1000XS-L100A1

Mar. 1, 2023 - 11:24 AM P:\2021\21-0125-00 - CAD Files\CAD\H1\GUser\H1\Drawing\Production\000_Design\Sections\H1-0125-1000A1-L100A1

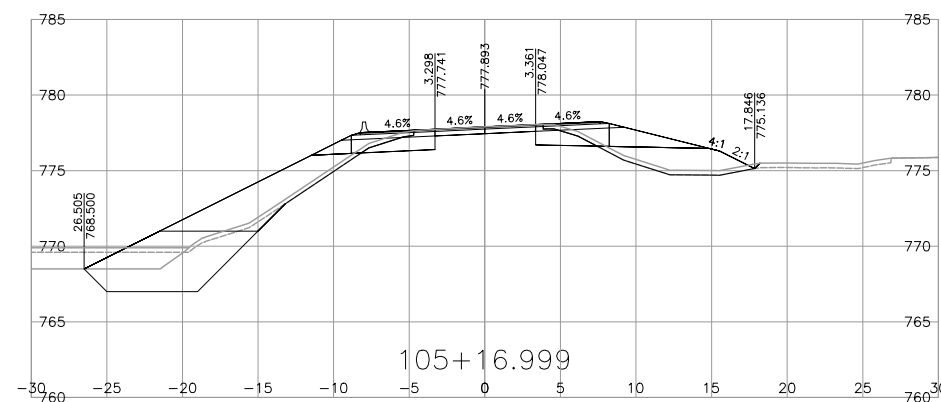
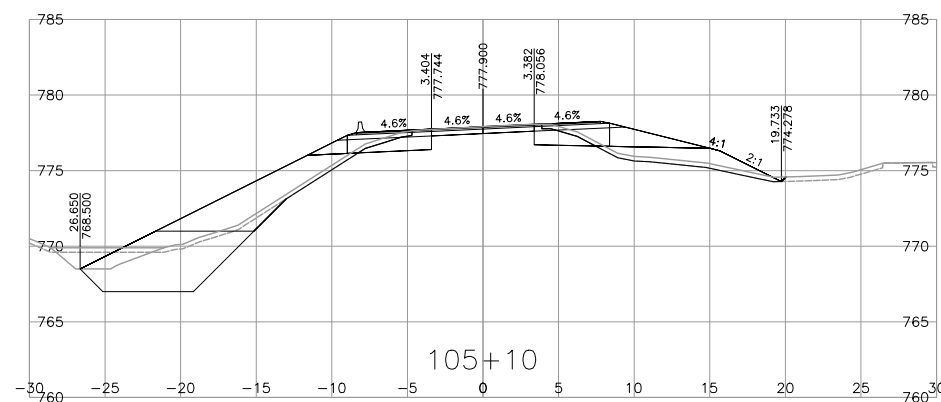
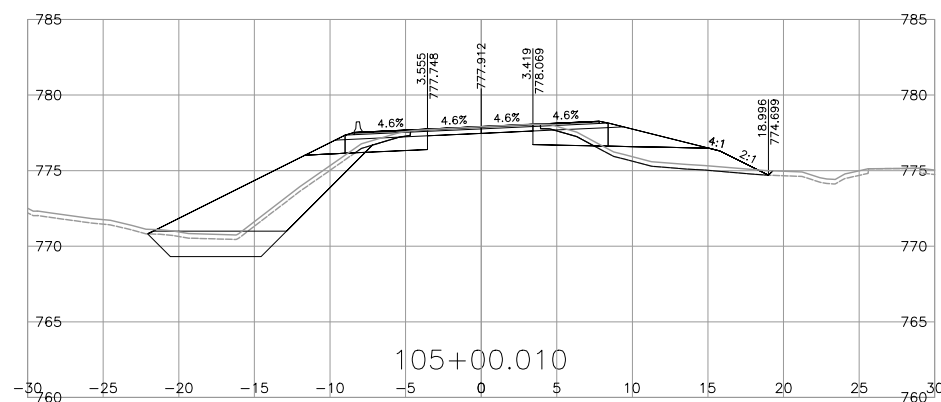
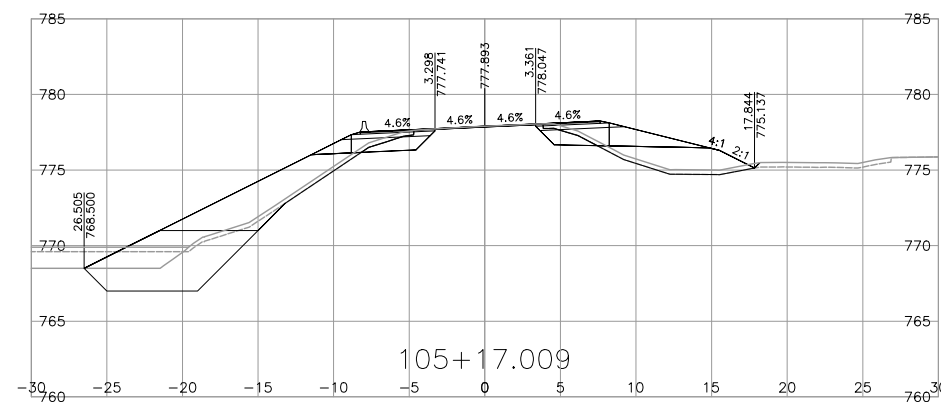
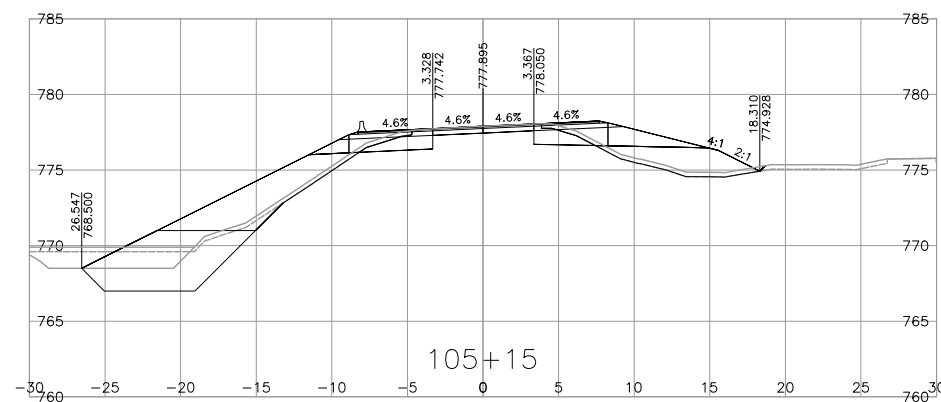
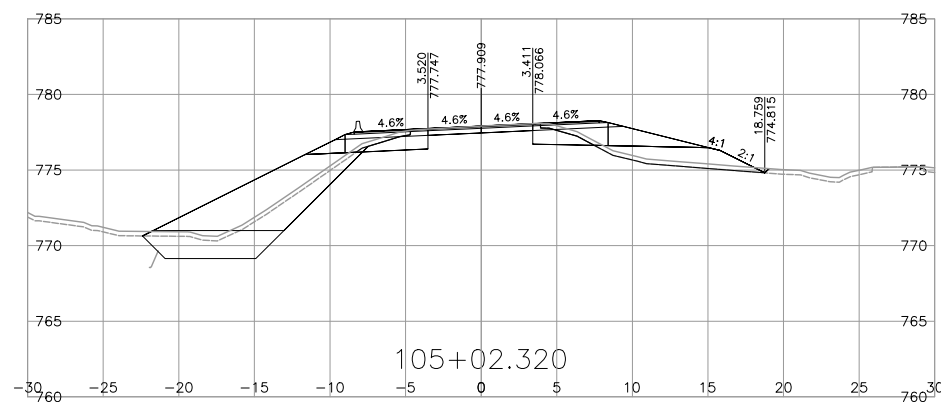
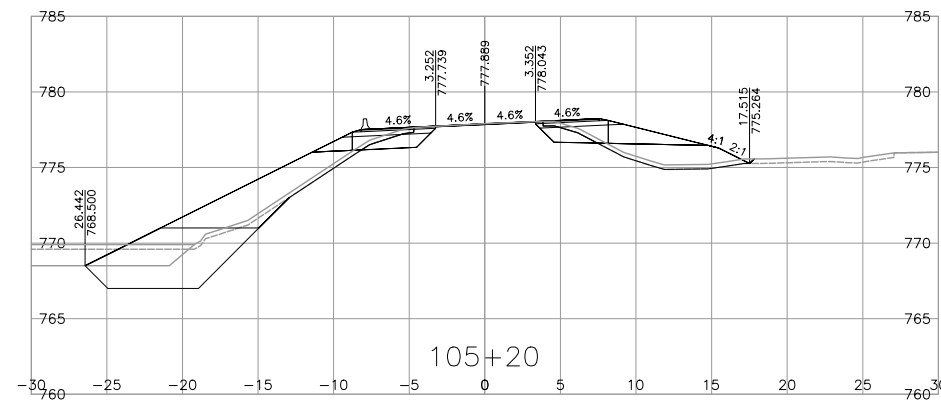
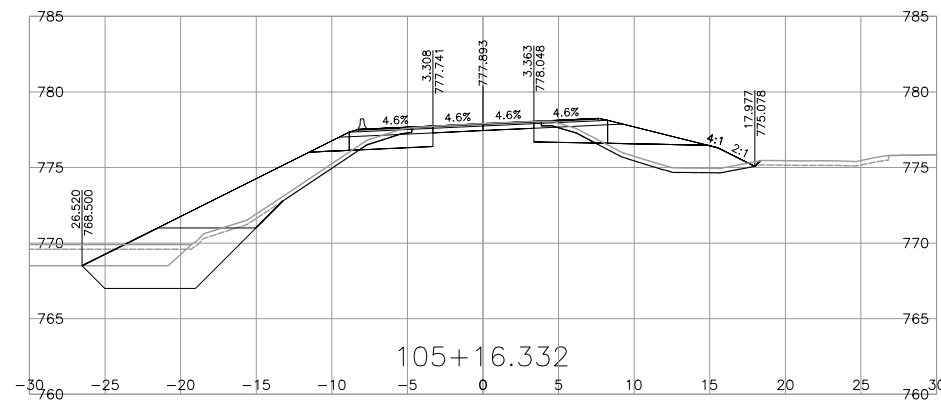
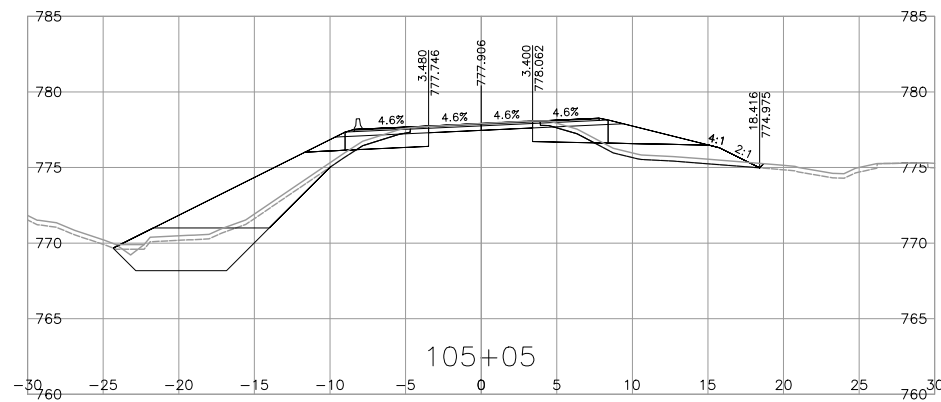

NOTE: STRIPPING REMOVAL APPLIES ONLY TO THE AREA BETWEEN SLOPE STAKE LINES (TOES & TOP OF CUT) OF PROPOSED ROADWAY TEMPLATE

FOR REFERENCE ONLY

DRAFT

FOR INFORMATION ONLY MARCH 03, 2023

<p>BINNIE The people behind your infrastructure.</p>		<p>R.F. BINNIE & ASSOCIATES LTD. 101 - 1577 7th Avenue, Prince George, BC V2L 3P5 TEL 250 561 7274 BINNIE.com</p>		<p>BRITISH COLUMBIA</p>		<p>MINISTRY OF TRANSPORTATION AND INFRASTRUCTURE NORTHERN REGION HIGHWAY ENGINEERING AND GEOMATICS</p>	
<p>SCALE </p>		<p>CAD FILENAME: 21-0125-1000XS-1-100A1.DWG DATE: 2023-03-01 FILE NUMBER: 21-0125-00</p>		<p>L100A1-LINE CROSS SECTIONS HIGHWAY 16 GUEST ROAD AND SHALLOW BAY ROAD INTERSECTIONS</p>			
REV	DATE	REVISIONS	SIGNATURE	<p>DESIGNED: _____ R.M. DATE: MAR. 2023 QUALITY CONTROL: _____ K.T. DATE: MAR. 2023 QUALITY ASSURANCE: _____ R.M. DATE: MAR. 2023 DRAWN: _____ J.D. DATE: MAR. 2023</p>		<p>PROJECT NUMBER: 38199-0000 REG: 3 DRAWING NUMBER: -L100A1-7XS</p>	
<p>R. Mankowske ENGINEER OF RECORD DATE: 20230303</p>				<p>DESIGNED: _____ R.M. DATE: MAR. 2023 QUALITY CONTROL: _____ K.T. DATE: MAR. 2023 QUALITY ASSURANCE: _____ R.M. DATE: MAR. 2023 DRAWN: _____ J.D. DATE: MAR. 2023</p>		<p>PROJECT NUMBER: 38199-0000 REG: 3 DRAWING NUMBER: -L100A1-7XS</p>	

Mar. 1, 2023 - 11:24 AM P:\2021\21-0125-00 - CAD Files\CAD-Highway\Production\000_Design\Sections\1-0125-1000XS-L100A1

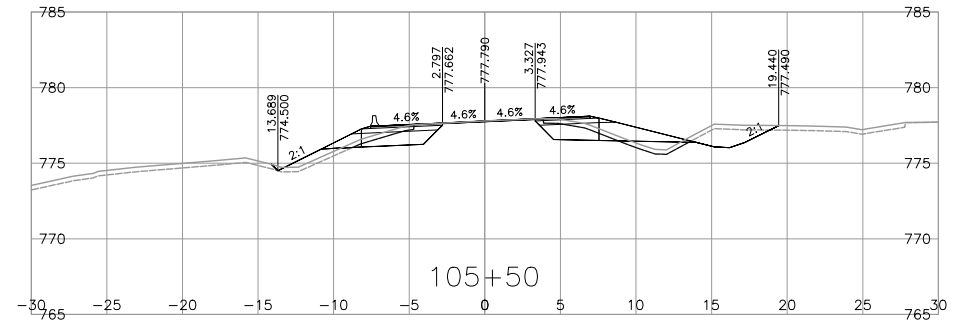
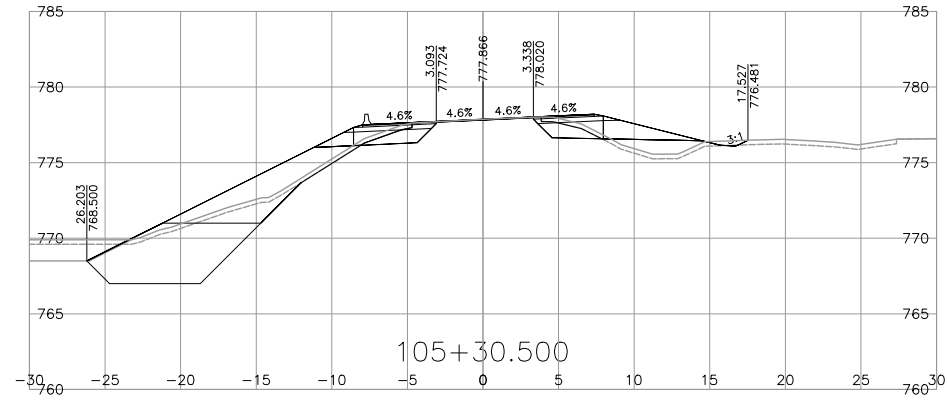
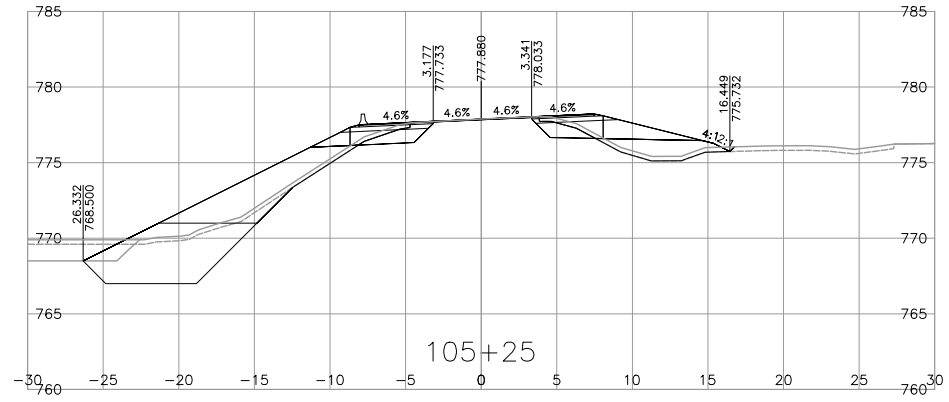
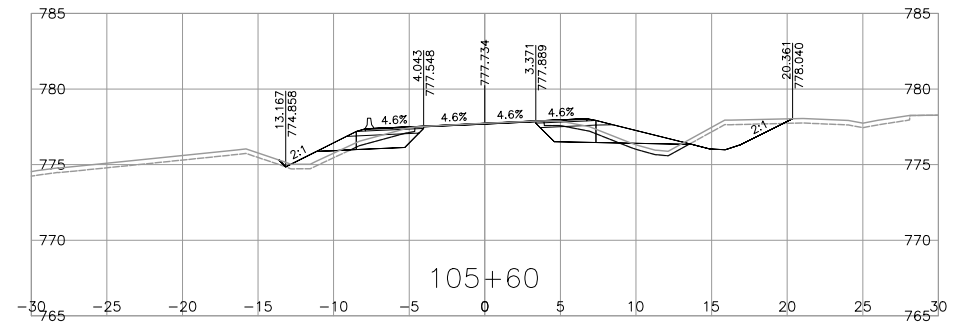
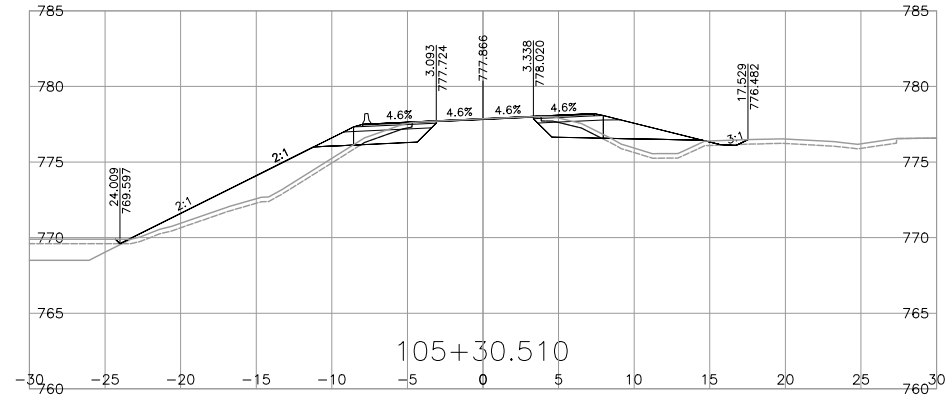
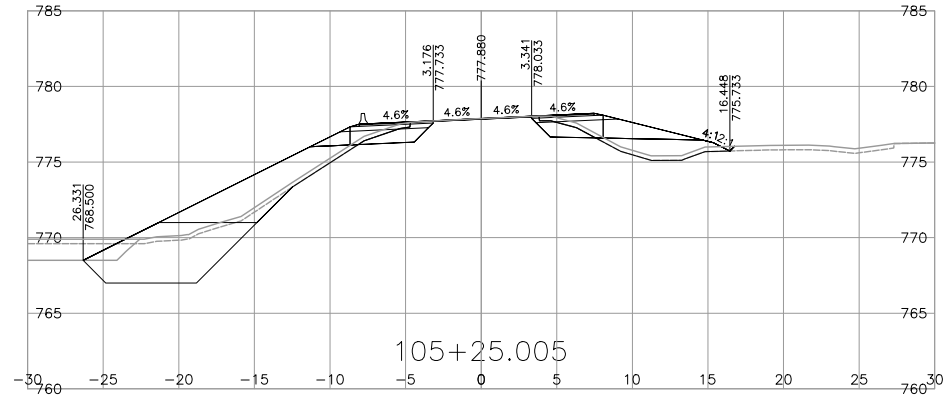
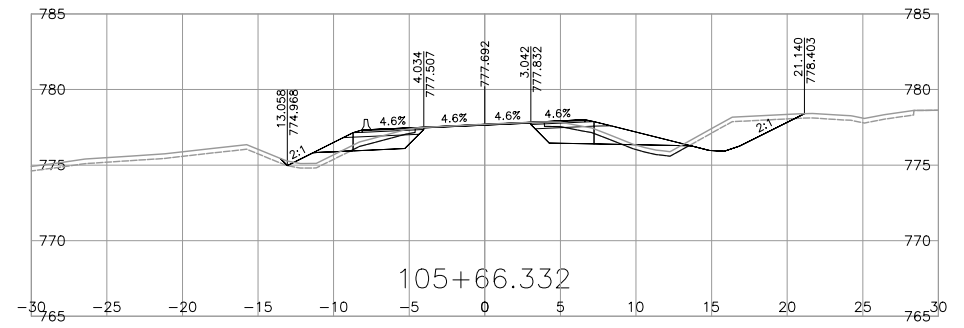
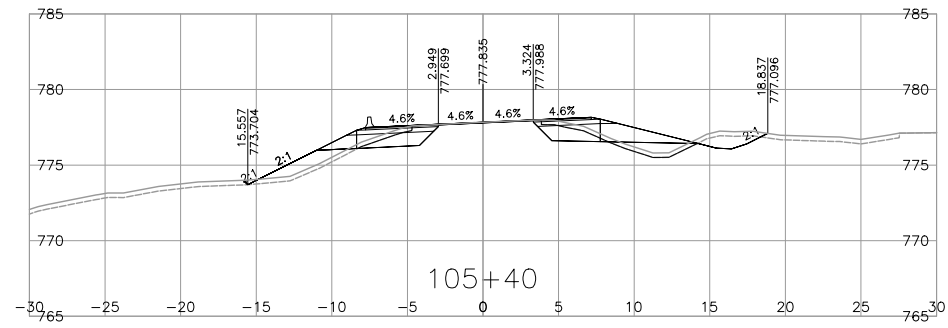
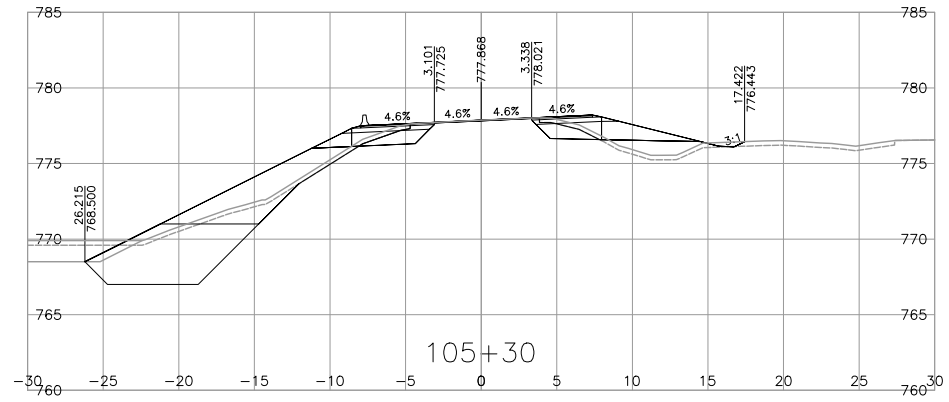

NOTE: STRIPPING REMOVAL APPLIES ONLY TO THE AREA BETWEEN SLOPE STAKE LINES (TOES & TOP OF CUT) OF PROPOSED ROADWAY TEMPLATE

FOR REFERENCE ONLY

DRAFT

FOR INFORMATION ONLY MARCH 03, 2023

<p>BINNIE The people behind your infrastructure.</p>	<p>R.F. BINNIE & ASSOCIATES LTD. 101 - 1577 7th Avenue, Prince George, BC V2L 3P5 TEL 250 561 7274 BINNIE.com</p>	<p>MINISTRY OF TRANSPORTATION AND INFRASTRUCTURE NORTHERN REGION HIGHWAY ENGINEERING AND GEOMATICS</p>																								
	<p>L100A1-LINE CROSS SECTIONS HIGHWAY 16 GUEST ROAD AND SHALLOW BAY ROAD INTERSECTIONS</p>																									
<p>SCALE CAD FILENAME 21-0125-1000XS-L100A1.DWG DATE 2023-03-01 FILE NUMBER 21-0125-00</p>																										
<table border="1"> <thead> <tr> <th>REV</th> <th>DATE</th> <th>REVISIONS</th> <th>SIGNATURE</th> </tr> </thead> <tbody> <tr><td> </td><td> </td><td> </td><td> </td></tr> <tr><td> </td><td> </td><td> </td><td> </td></tr> <tr><td> </td><td> </td><td> </td><td> </td></tr> <tr><td> </td><td> </td><td> </td><td> </td></tr> <tr><td> </td><td> </td><td> </td><td> </td></tr> </tbody> </table>	REV	DATE	REVISIONS	SIGNATURE																					<p>DESIGNED _____ R.M. DATE MAR. 2023 QUALITY CONTROL _____ K.T. DATE MAR. 2023 QUALITY ASSURANCE _____ R.M. DATE MAR. 2023 DRAWN _____ J.D. DATE MAR. 2023</p>	
REV	DATE	REVISIONS	SIGNATURE																							
<p>R. Mankowske ENGINEER OF RECORD DATE 20230303</p>		<p>PROJECT NUMBER 38199-0000 REG 3 DRAWING NUMBER -L100A1-8XS</p>																								

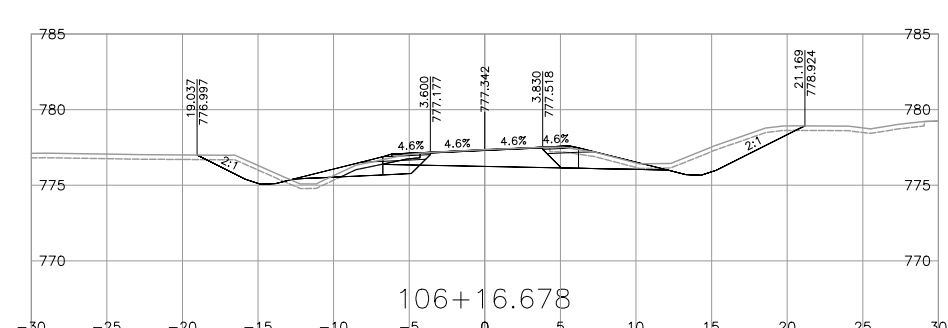
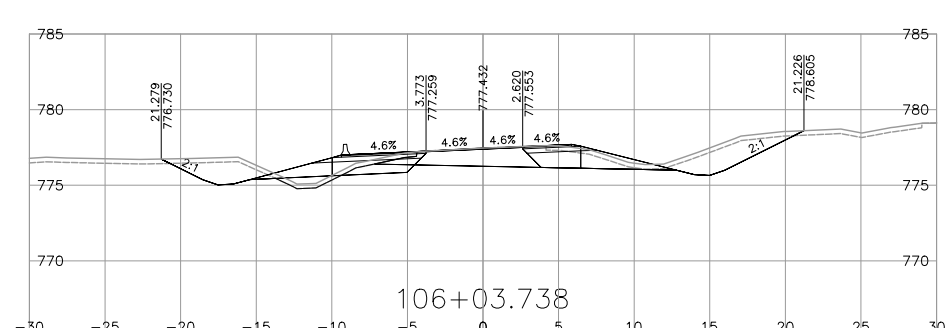
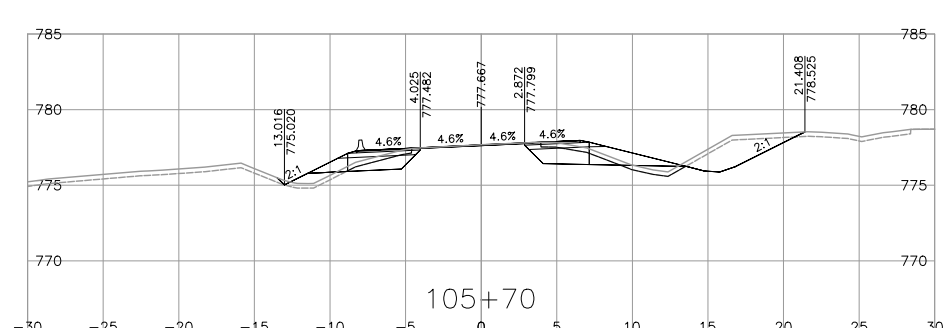
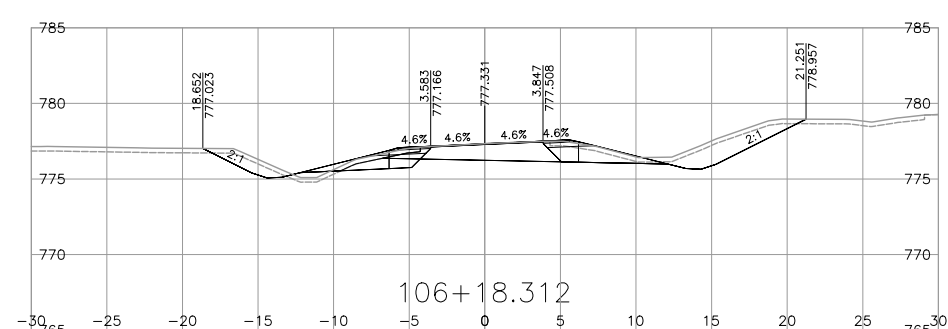
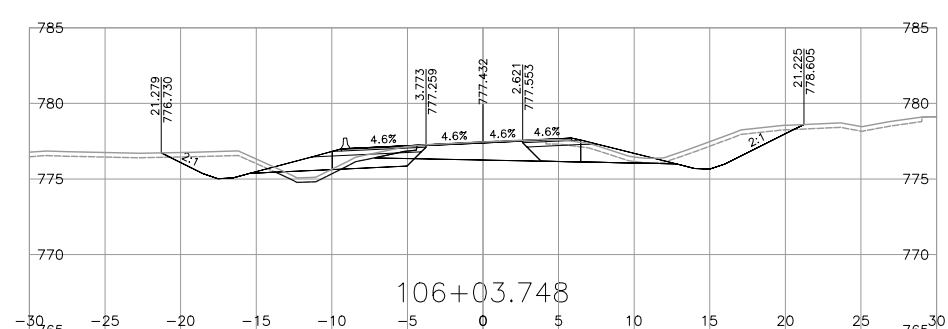
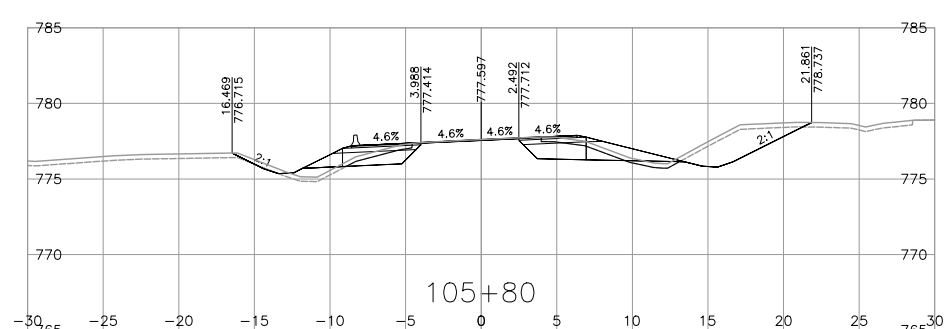
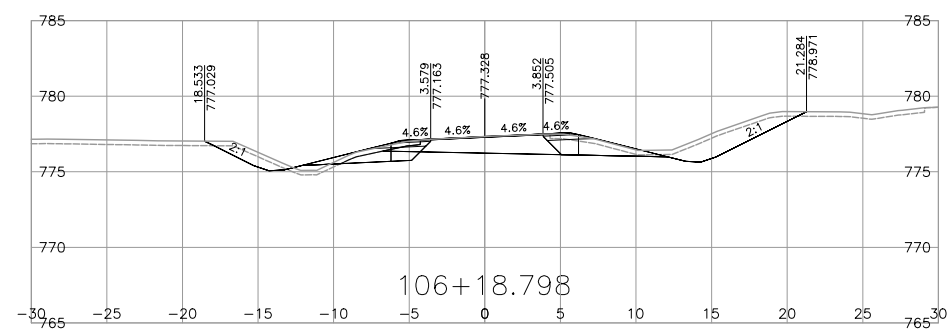
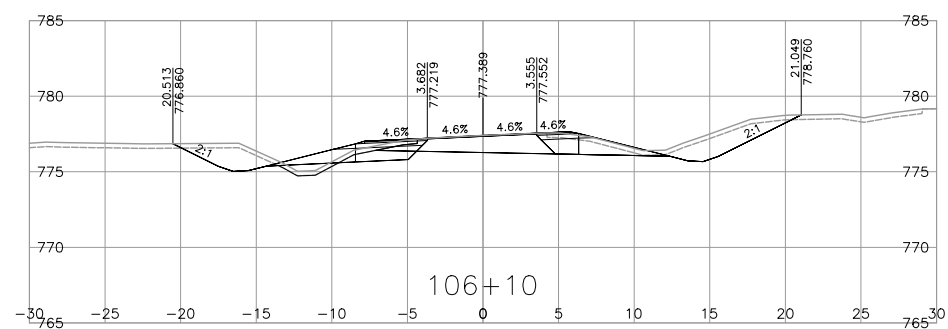
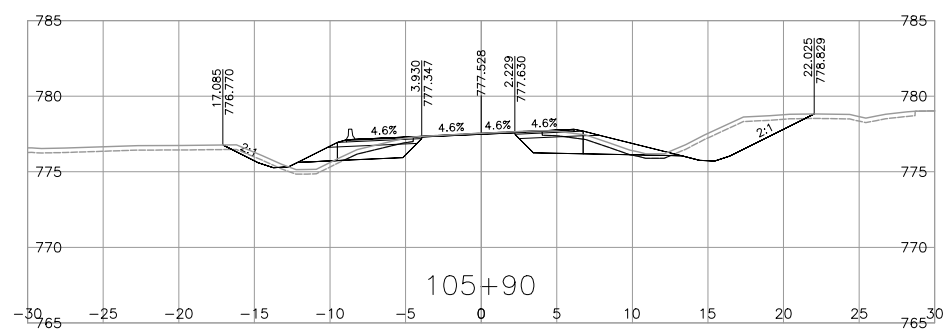
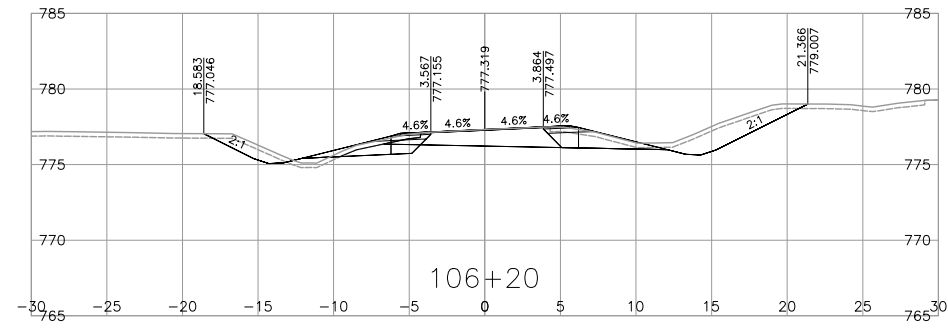
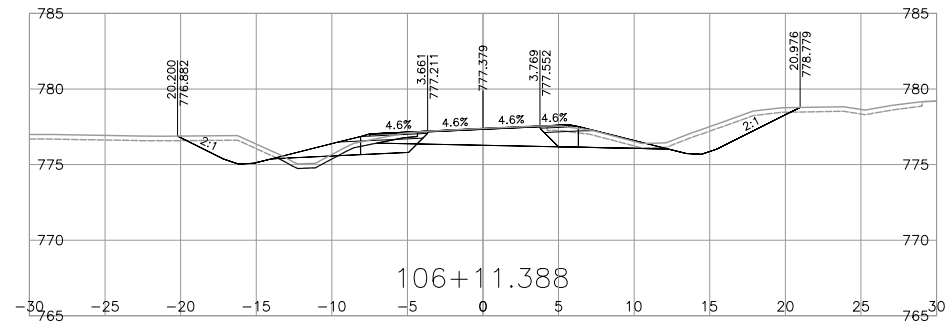
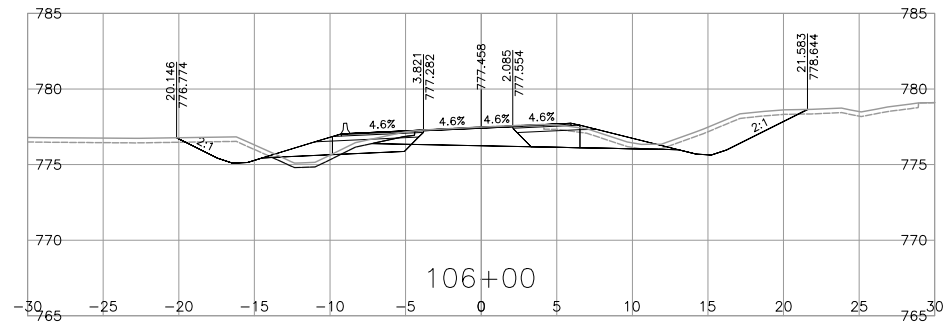

NOTE: STRIPPING REMOVAL APPLIES ONLY TO THE AREA BETWEEN SLOPE STAKE LINES (TOES & TOP OF CUT) OF PROPOSED ROADWAY TEMPLATE

FOR REFERENCE ONLY

DRAFT

FOR INFORMATION ONLY MARCH 03, 2023

BINNIE
The people behind your infrastructure.

R.F. BINNIE & ASSOCIATES LTD.
101 - 1577 7th Avenue,
Prince George, BC V2L 3P5
TEL 250 561 7274
BINNIE.com

BRITISH COLUMBIA
MINISTRY OF TRANSPORTATION AND INFRASTRUCTURE
NORTHERN REGION
HIGHWAY ENGINEERING AND GEOMATICS

L100A1-LINE CROSS SECTIONS
HIGHWAY 16
GUEST ROAD AND SHALLOW BAY ROAD INTERSECTIONS

SCALE

CAD FILENAME: 21-0125-1000XS-L100A1.DWG
DATE: 2023-03-01
FILE NUMBER: 21-0125-00

REV	DATE	REVISIONS	SIGNATURE

DESIGNED	_____	R.M.	DATE	MAR. 2023
QUALITY CONTROL	_____	K.T.	DATE	MAR. 2023
QUALITY ASSURANCE	_____	R.M.	DATE	MAR. 2023
DRAWN	_____	J.D.	DATE	MAR. 2023
PROJECT NUMBER	38199-0000	REG	3	DRAWING NUMBER
				-L100A1-9XS

R. Mankowske
ENGINEER OF RECORD
DATE 20230303

Mar. 1, 2023 - 11:24 AM P:\2021\21-0125-00 - CAD Files\CSD\H1\GUser\RF\Drawing\Production\1000_Design\Sections\H1-0125-1000XS-L100A1

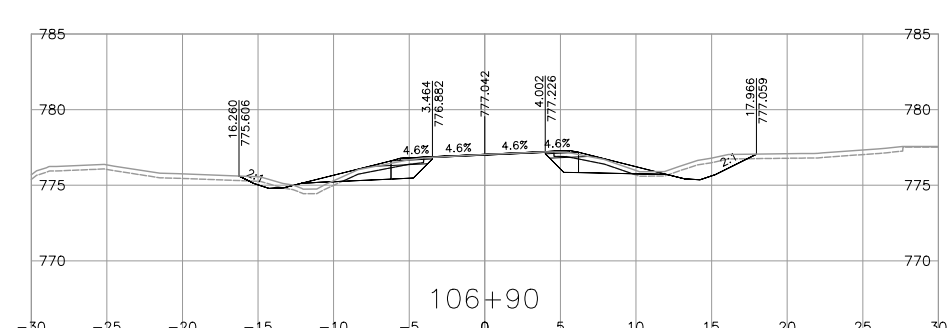
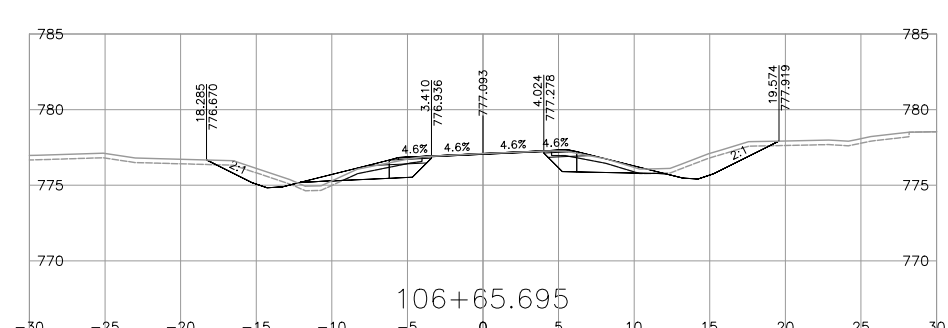
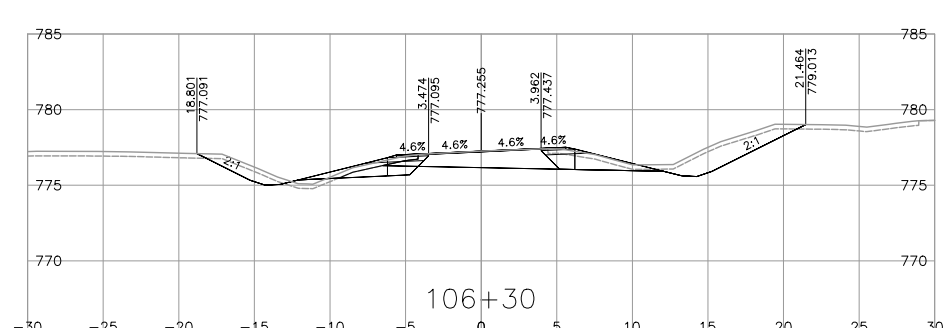
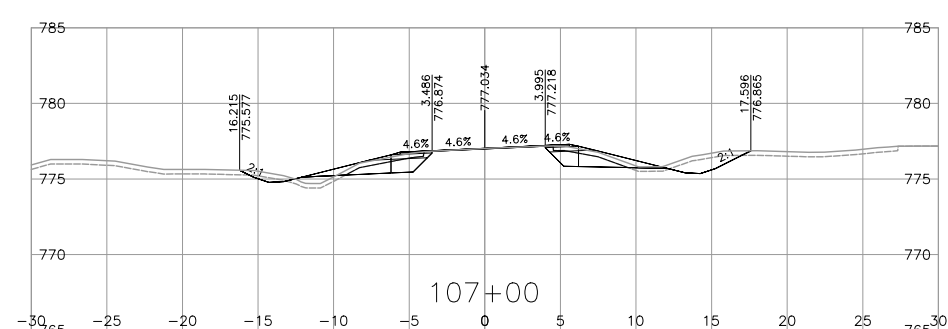
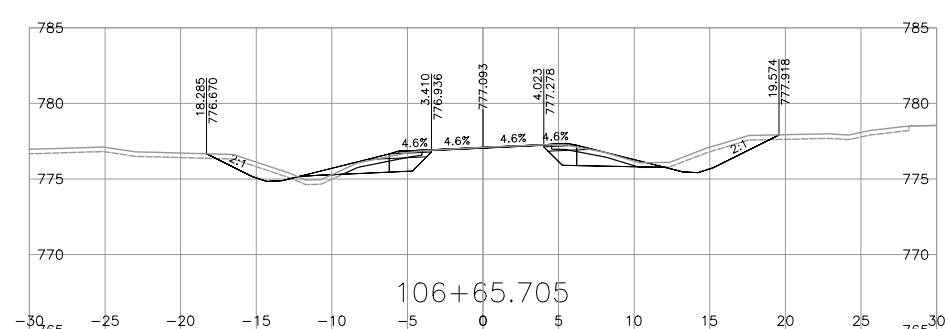
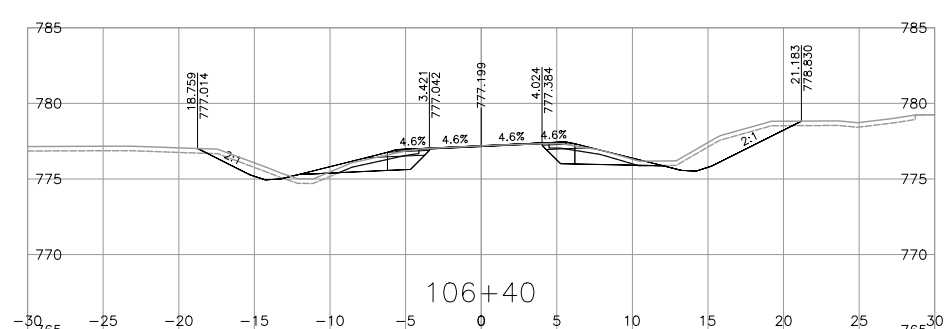
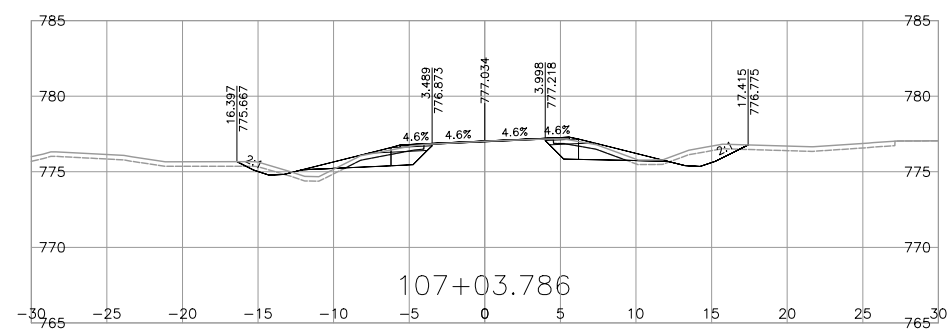
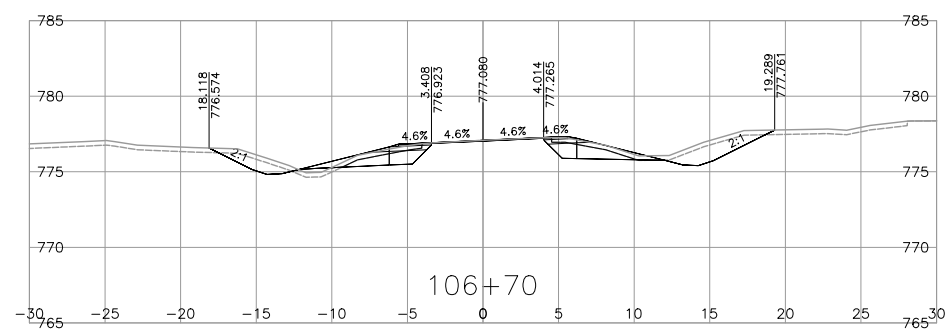
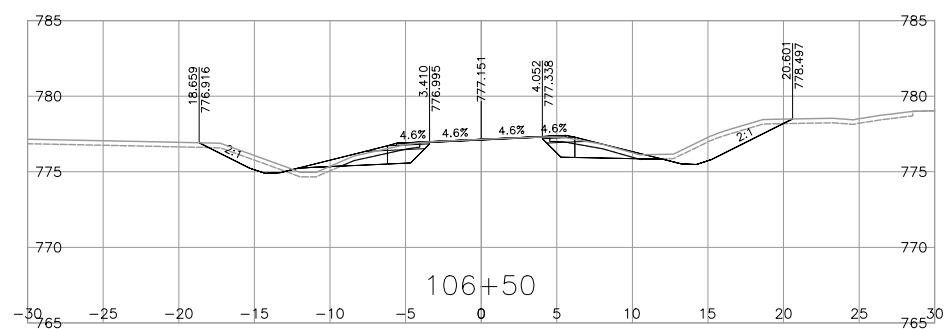
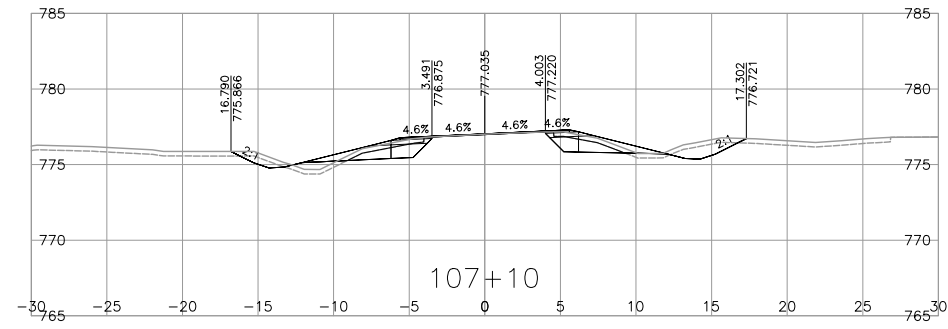
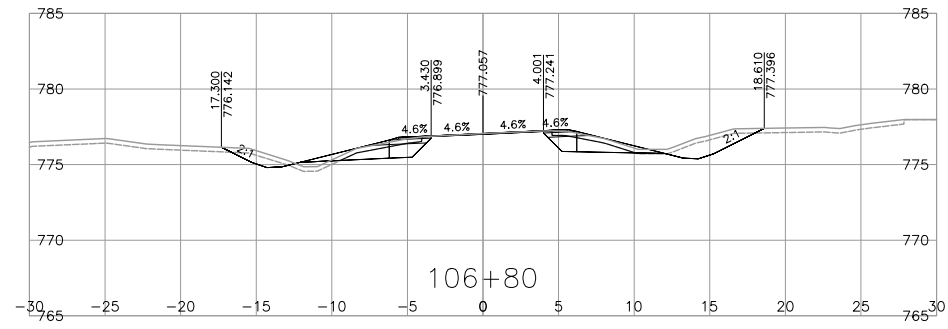
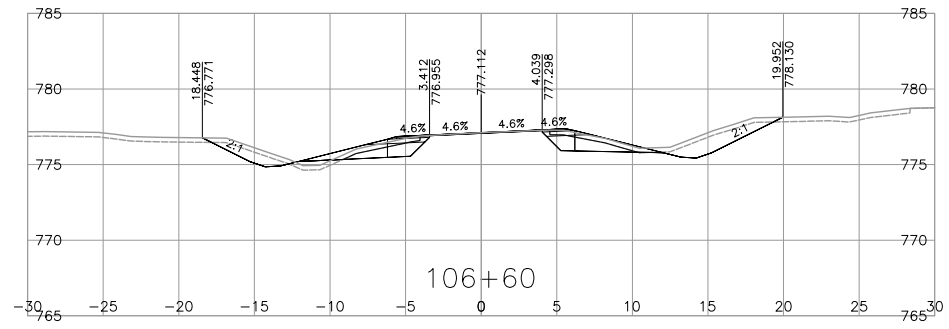

NOTE: STRIPPING REMOVAL APPLIES ONLY TO THE AREA BETWEEN SLOPE STAKE LINES (TOES & TOP OF CUT) OF PROPOSED ROADWAY TEMPLATE

FOR REFERENCE ONLY

DRAFT

FOR INFORMATION ONLY MARCH 03, 2023

BINNIE
The people behind your infrastructure.

R.F. BINNIE & ASSOCIATES LTD.
101 - 1577 7th Avenue,
Prince George, BC V2L 3P5
TEL 250 561 7274
BINNIE.com

BRITISH COLUMBIA

MINISTRY OF TRANSPORTATION AND INFRASTRUCTURE
NORTHERN REGION
HIGHWAY ENGINEERING AND GEOMATICS

L100A1-LINE CROSS SECTIONS
HIGHWAY 16
GUEST ROAD AND SHALLOW BAY ROAD INTERSECTIONS

SCALE

CAD FILENAME: 21-0125-1000XS-1-100A1.DWG
DATE: 2023-03-01
FILE NUMBER: 21-0125-00

REV	DATE	REVISIONS	SIGNATURE

DESIGNED	_____	R.M.	DATE	MAR. 2023
QUALITY CONTROL	_____	K.T.	DATE	MAR. 2023
QUALITY ASSURANCE	_____	R.M.	DATE	MAR. 2023
DRAWN	_____	J.D.	DATE	MAR. 2023

R. Mankowske
ENGINEER OF RECORD
DATE 20230303

PROJECT NUMBER	38199-0000	REG	3	DRAWING NUMBER	-L100A1-10XS	REV	
----------------	------------	-----	---	----------------	--------------	-----	--

Mar. 1, 2023 - 11:24 AM P:\2021\21-0125-00 - CAD Files\CAD-Files\H1-Drawing\Production\000_Design\Sections\H1-0125-1000XS-L100A1

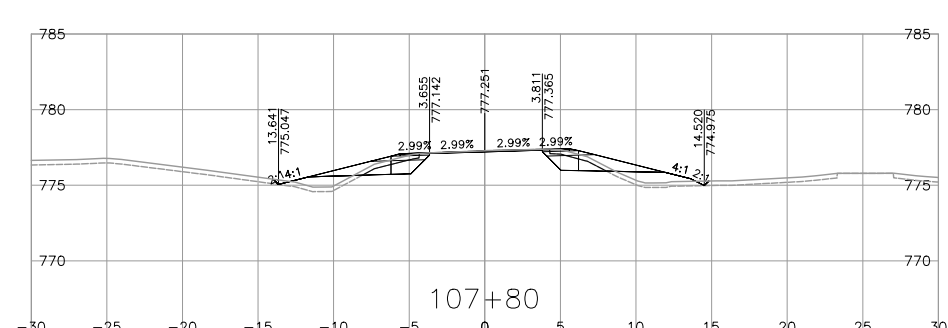
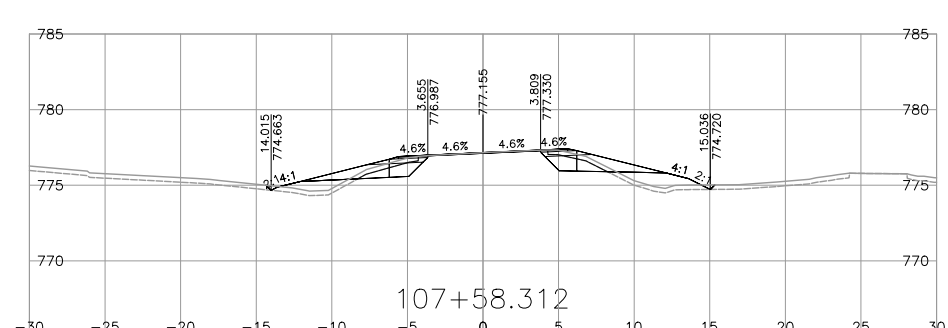
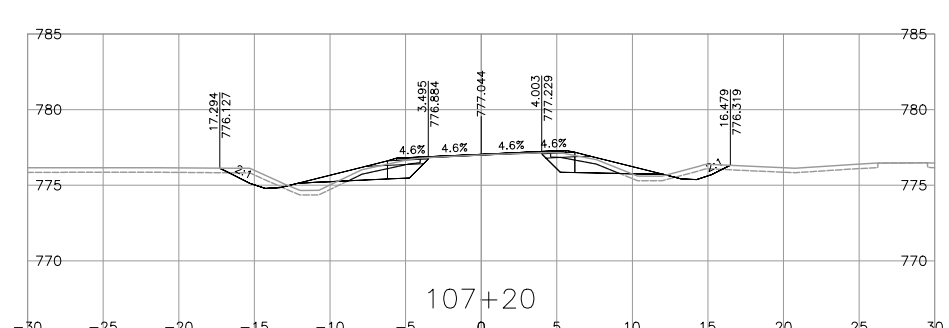
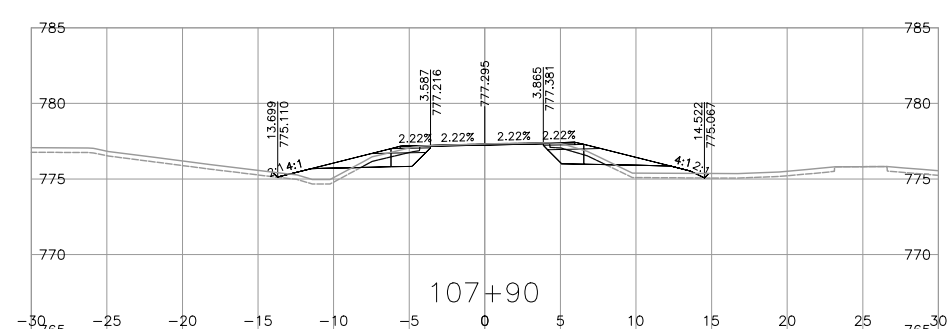
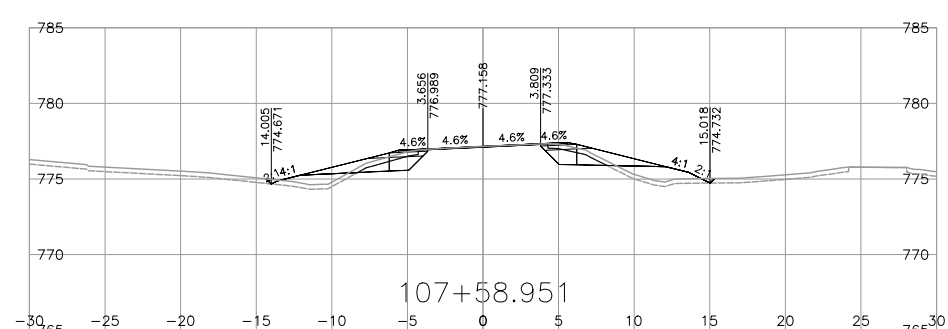
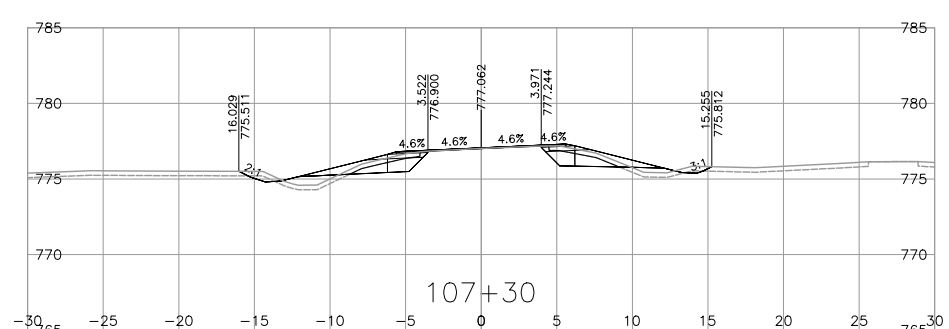
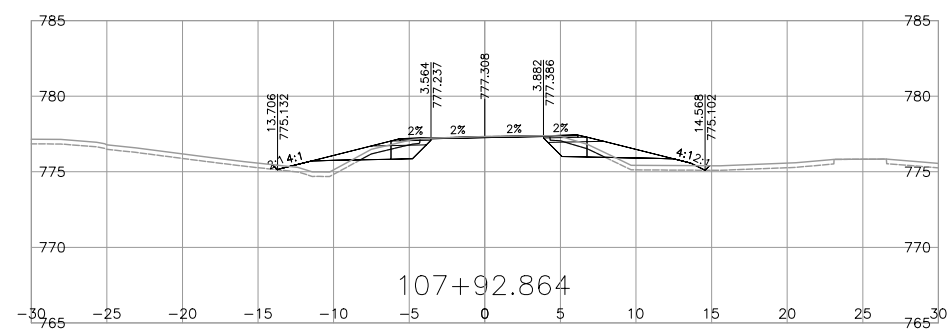
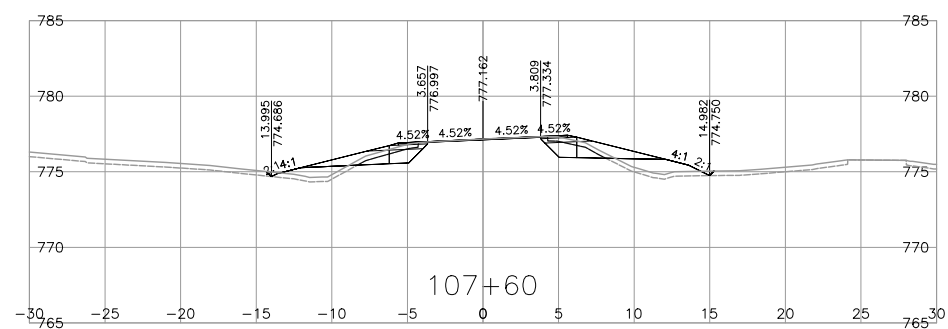
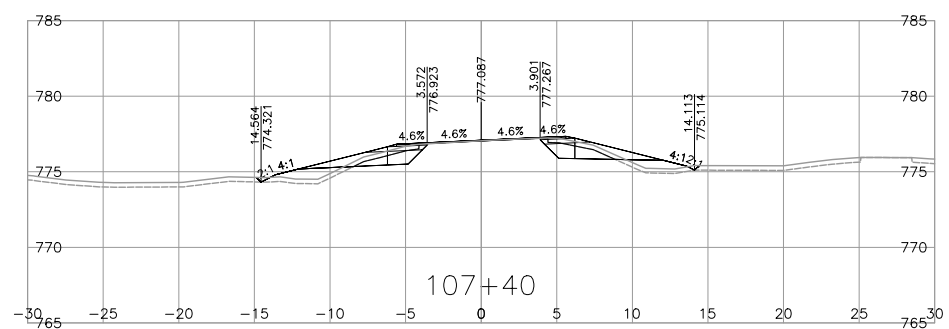
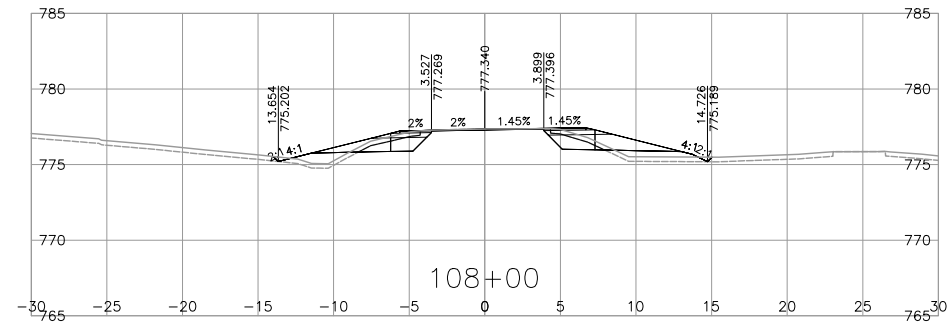
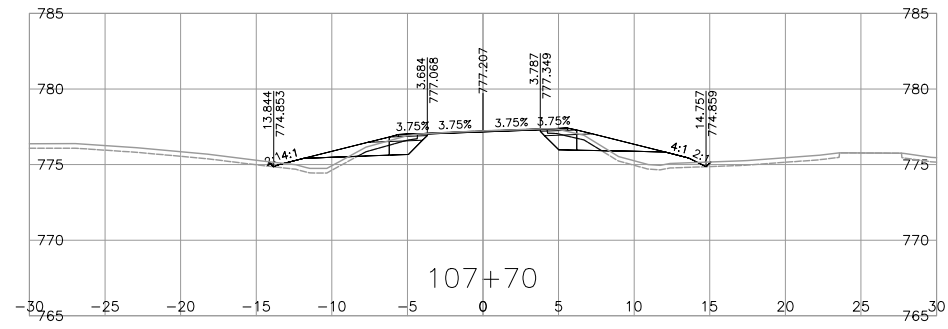
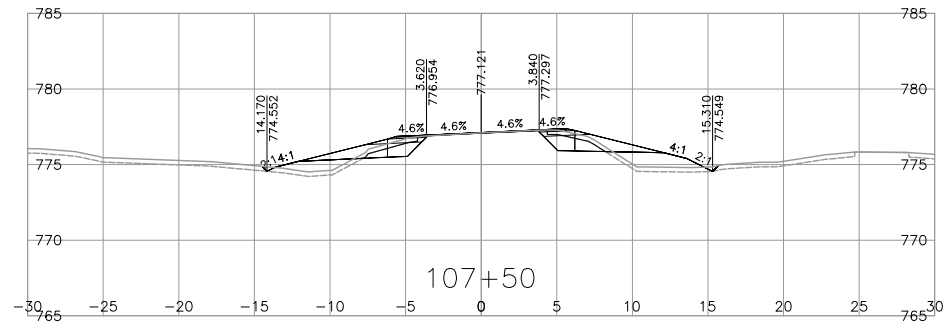

NOTE: STRIPPING REMOVAL APPLIES ONLY TO THE AREA BETWEEN SLOPE STAKE LINES (TOES & TOP OF CUT) OF PROPOSED ROADWAY TEMPLATE

FOR REFERENCE ONLY

DRAFT

FOR INFORMATION ONLY MARCH 03, 2023

R.F. BINNIE & ASSOCIATES LTD.
101 - 1577 7th Avenue,
Prince George, BC V2L 3P5
TEL 250 561 7274
BINNIE.com

BRITISH COLUMBIA

MINISTRY OF TRANSPORTATION AND INFRASTRUCTURE
NORTHERN REGION
HIGHWAY ENGINEERING AND GEOMATICS

L100A1-LINE CROSS SECTIONS
HIGHWAY 16
GUEST ROAD AND SHALLOW BAY ROAD INTERSECTIONS

SCALE: 0 2 1:250 12m

CAD FILENAME: 21-0125-1000XS-1-100A1.DWG
DATE: 2023-03-01
FILE NUMBER: 21-0125-00

REV	DATE	REVISIONS	SIGNATURE

R. Mankowske
ENGINEER OF RECORD
DATE: 20230303

DESIGNED	_____	R.M.	DATE	MAR. 2023
QUALITY CONTROL	_____	K.T.	DATE	MAR. 2023
QUALITY ASSURANCE	_____	R.M.	DATE	MAR. 2023
DRAWN	_____	J.D.	DATE	MAR. 2023
PROJECT NUMBER	38199-0000	REG	3	DRAWING NUMBER
				-L100A1-11XS

Mar. 1, 2023 - 11:24 AM P:\2021\21-0125-00 - CAD Files\CSD\H1\CrossRt1\DrawingProduction\1000_Design\Sections\0125-1000XS-L100A1

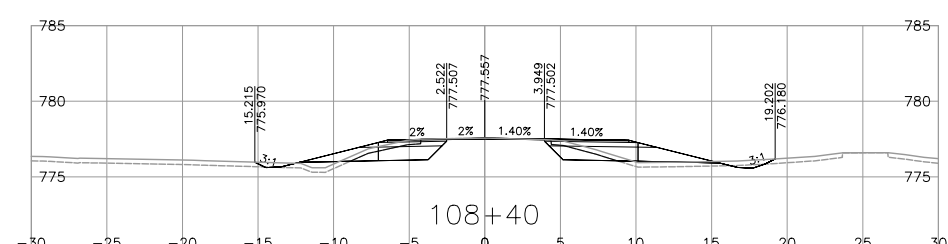
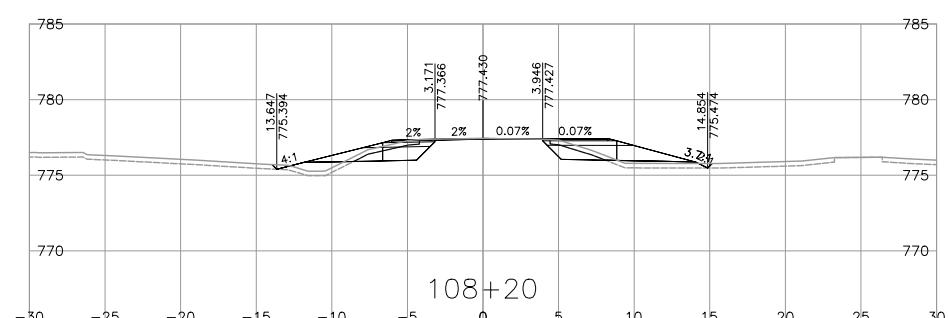
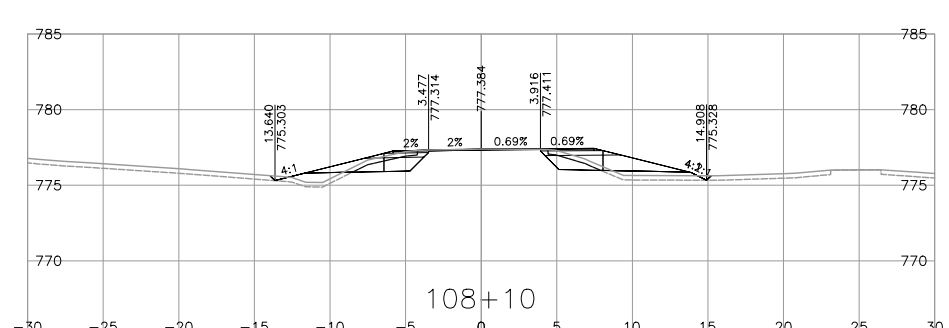
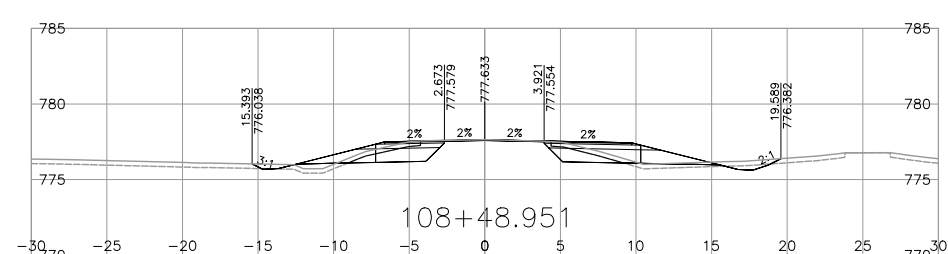
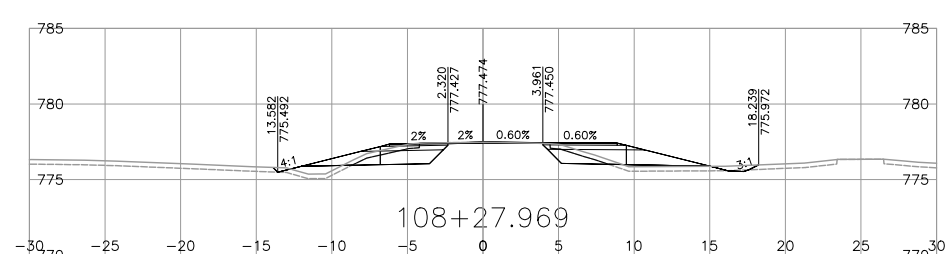
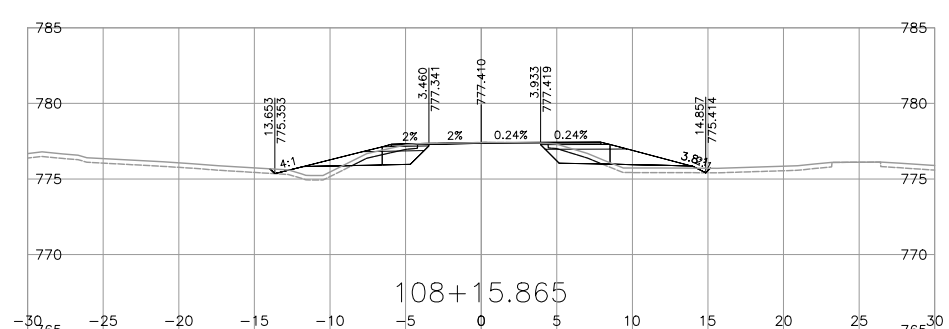
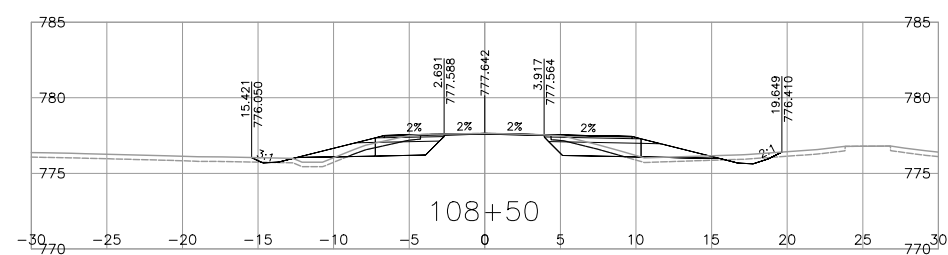
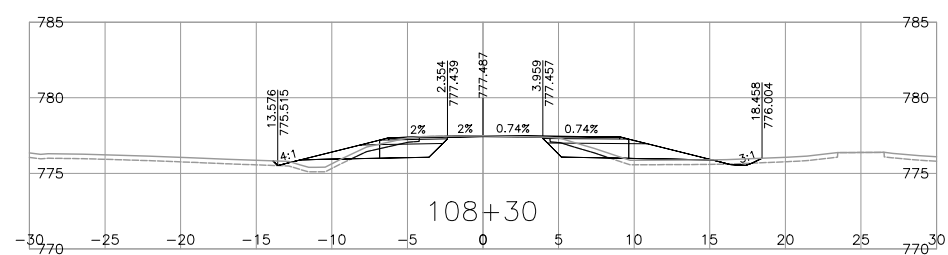
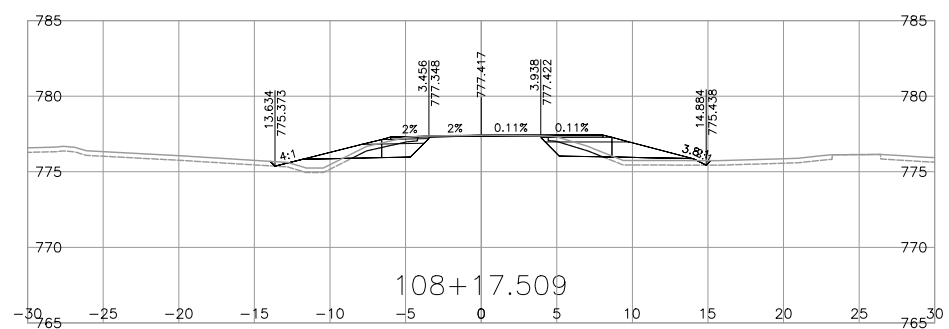
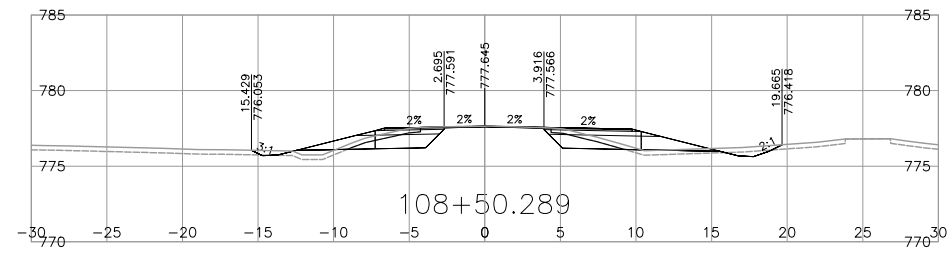
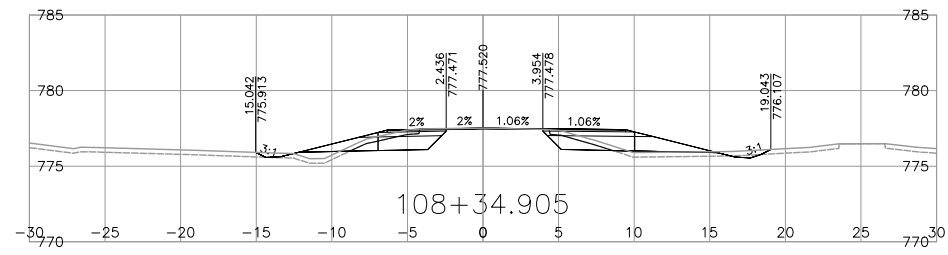
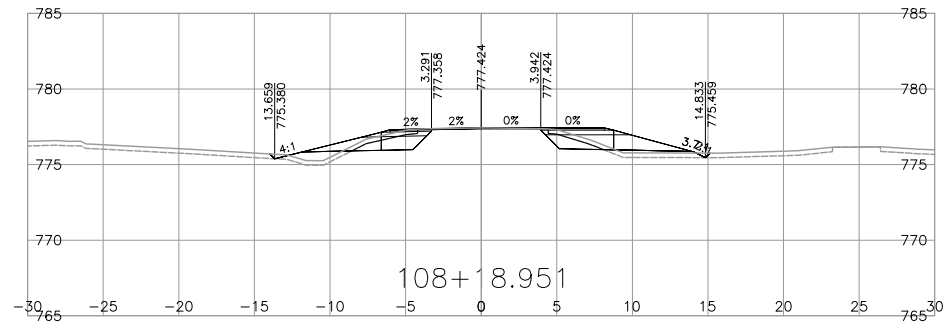

NOTE: STRIPPING REMOVAL APPLIES ONLY TO THE AREA BETWEEN SLOPE STAKE LINES (TOES & TOP OF CUT) OF PROPOSED ROADWAY TEMPLATE

FOR REFERENCE ONLY

DRAFT

FOR INFORMATION ONLY MARCH 03, 2023

BINNIE
The people behind your infrastructure.

R.F. BINNIE & ASSOCIATES LTD.
101 - 1577 7th Avenue,
Prince George, BC V2L 3P5
TEL 250 561 7274
BINNIE.com

BRITISH COLUMBIA
MINISTRY OF TRANSPORTATION AND INFRASTRUCTURE
NORTHERN REGION
HIGHWAY ENGINEERING AND GEOMATICS

L100A1-LINE CROSS SECTIONS
HIGHWAY 16
GUEST ROAD AND SHALLOW BAY ROAD INTERSECTIONS

SCALE

CAD FILENAME: 21-0125-1000XS-1-100A1.DWG
DATE: 2023-03-01
FILE NUMBER: 21-0125-00

REV	DATE	REVISIONS	SIGNATURE

DESIGNED	_____	R.M.	DATE	MAR. 2023
QUALITY CONTROL	_____	K.T.	DATE	MAR. 2023
QUALITY ASSURANCE	_____	R.M.	DATE	MAR. 2023
DRAWN	_____	J.D.	DATE	MAR. 2023
PROJECT NUMBER	38199-0000	REG	3	DRAWING NUMBER
				-L100A1-12XS

R. Mankowske
ENGINEER OF RECORD
DATE 20230303

Mar. 1, 2023 - 11:24 AM P:\2021\21-0125-00 - CAD Files\CAD-Files\H1-Drawing\Production\000_Design\Sections\0125-1000XS-L100A1

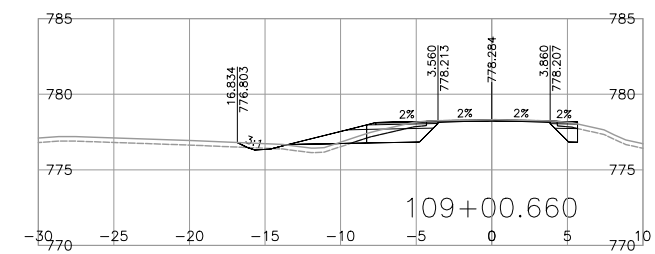
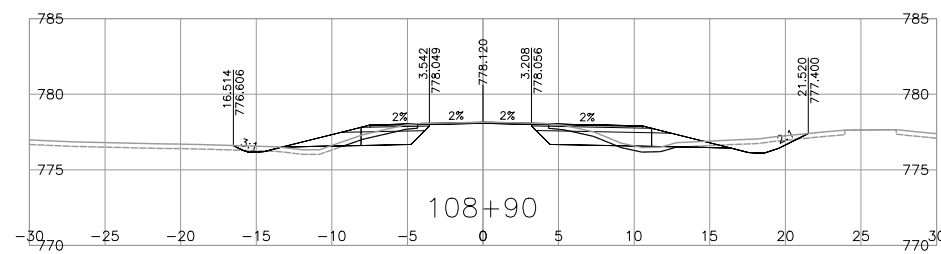
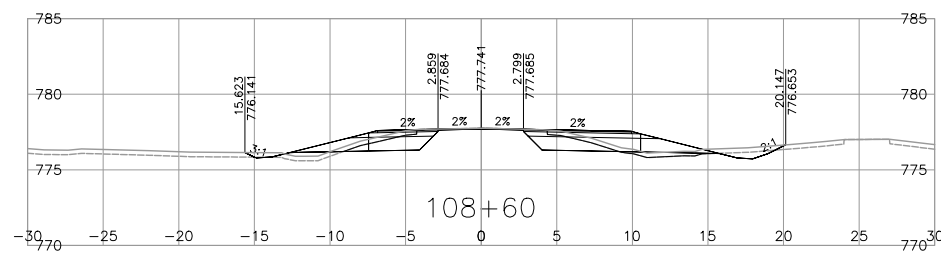
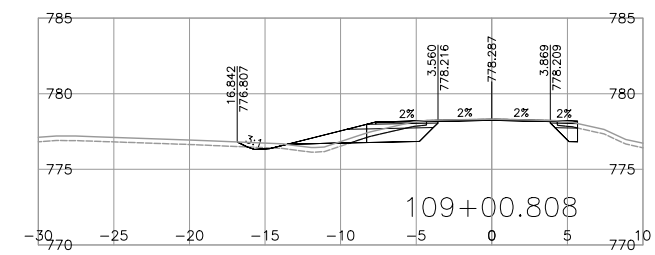
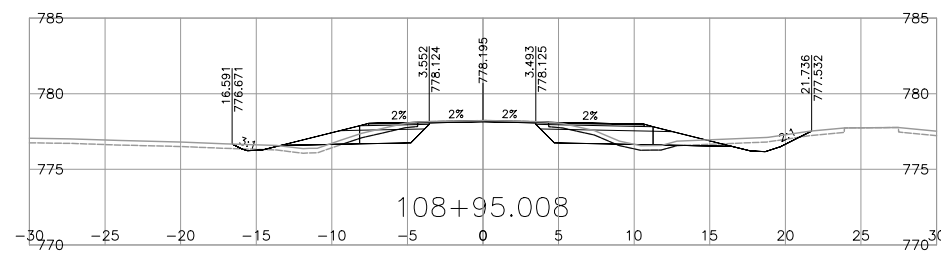
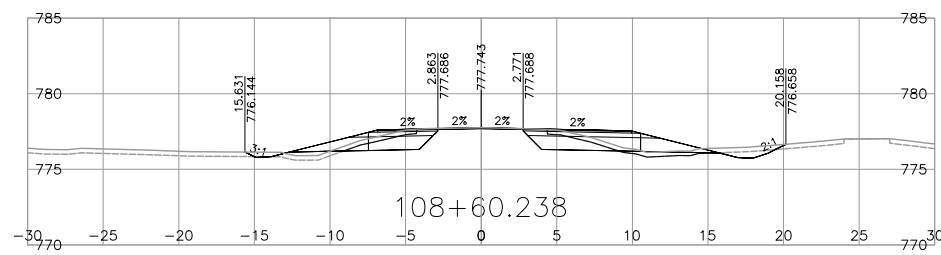
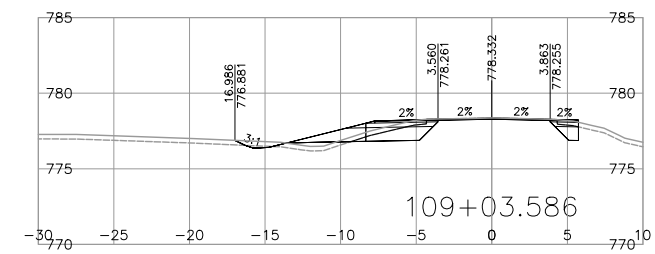
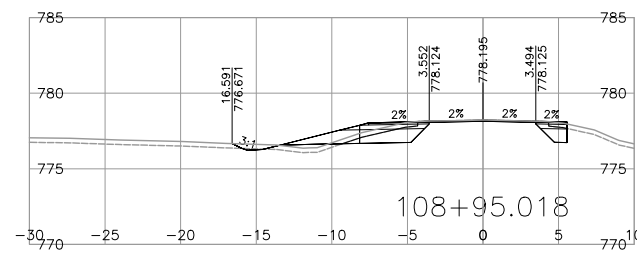
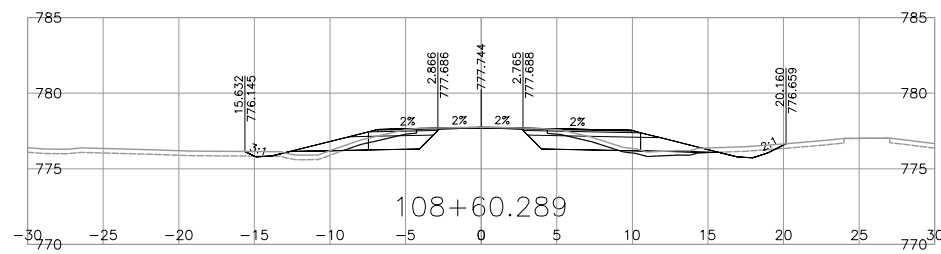
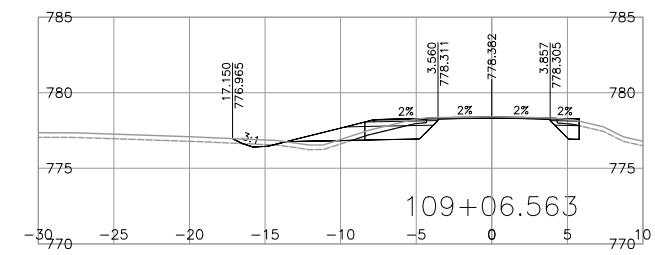
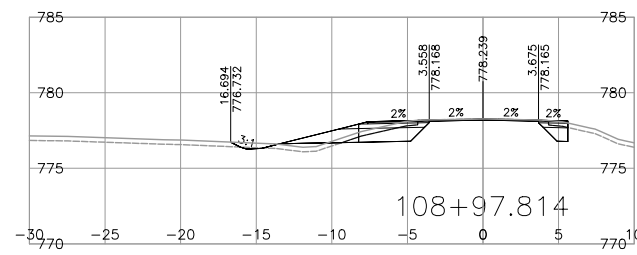
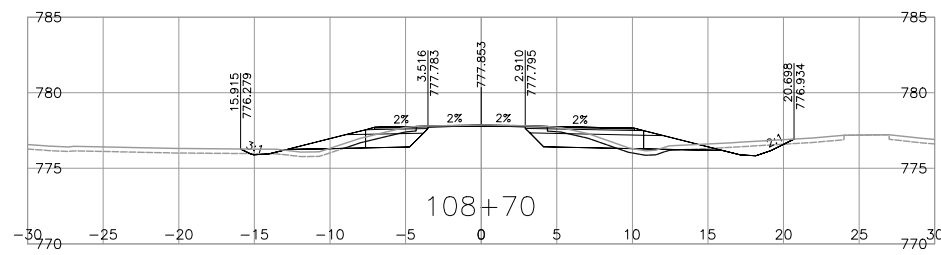
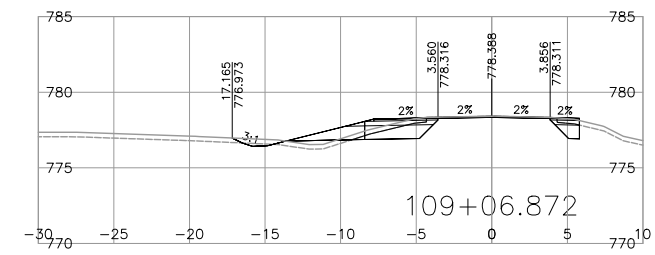
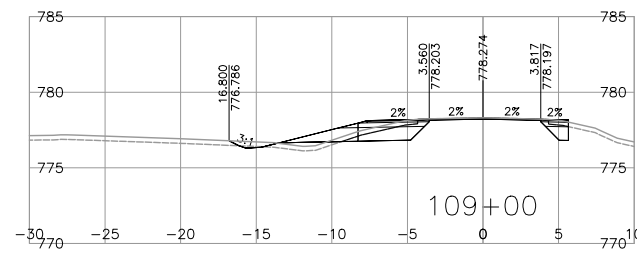
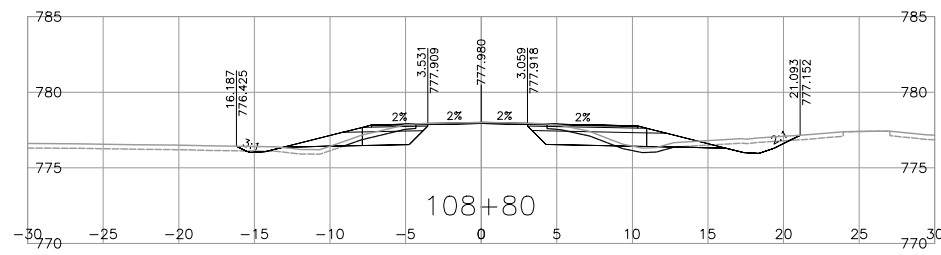

NOTE: STRIPPING REMOVAL APPLIES ONLY TO THE AREA BETWEEN SLOPE STAKE LINES (TOES & TOP OF CUT) OF PROPOSED ROADWAY TEMPLATE

FOR REFERENCE ONLY

DRAFT

FOR INFORMATION ONLY MARCH 03, 2023

BINNIE
The people behind your infrastructure.

R.F. BINNIE & ASSOCIATES LTD.
101 - 1577 7th Avenue,
Prince George, BC V2L 3P5
TEL 250 561 7274
BINNIE.com

BRITISH COLUMBIA
MINISTRY OF TRANSPORTATION AND INFRASTRUCTURE
NORTHERN REGION
HIGHWAY ENGINEERING AND GEOMATICS

SCALE 0 2 1:250 12m

CAD FILENAME 21-0125-1000XS-1-100A1.DWG
DATE 2023-03-01
FILE NUMBER 21-0125-00

REV	DATE	REVISIONS	SIGNATURE

L100A1-LINE CROSS SECTIONS
HIGHWAY 16
GUEST ROAD AND SHALLOW BAY ROAD INTERSECTIONS

DESIGNED	R.M.	DATE	MAR. 2023
QUALITY CONTROL	K.T.	DATE	MAR. 2023
QUALITY ASSURANCE	R.M.	DATE	MAR. 2023
DRAWN	J.D.	DATE	MAR. 2023
PROJECT NUMBER	REG	DRAWING NUMBER	REV
38199-0000	3	-L100A1-13XS	

R. Mankowske
ENGINEER OF RECORD
DATE 20230303

Mar. 1, 2023 - 11:24 AM P:\2021\21-0125-00 - CAD Files\CAD-Highway\Production\1000_Design\Sections\1-0125-1000XS-L100A1

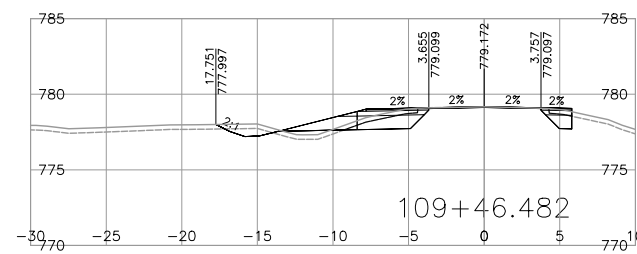
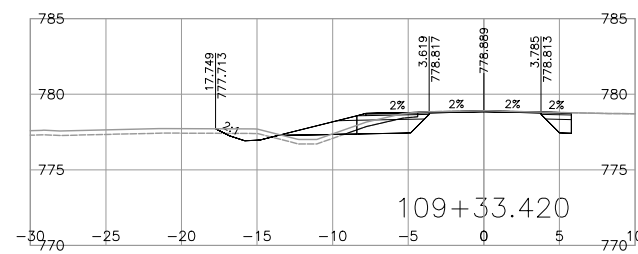
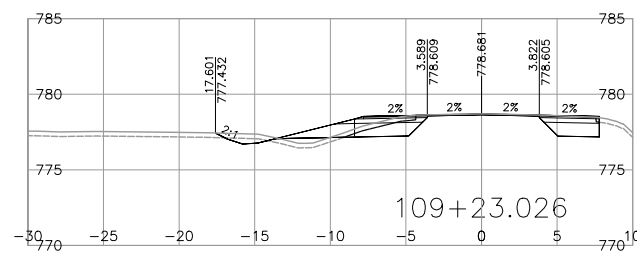
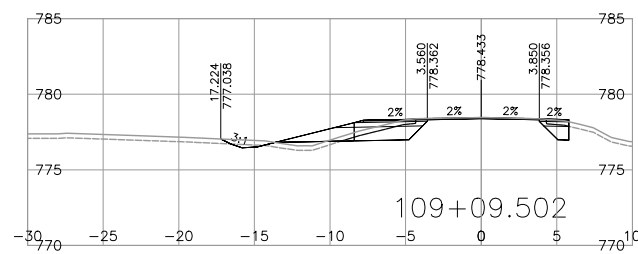
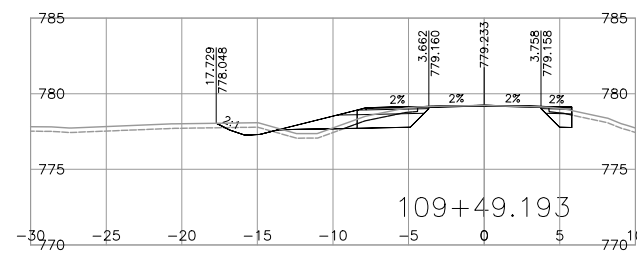
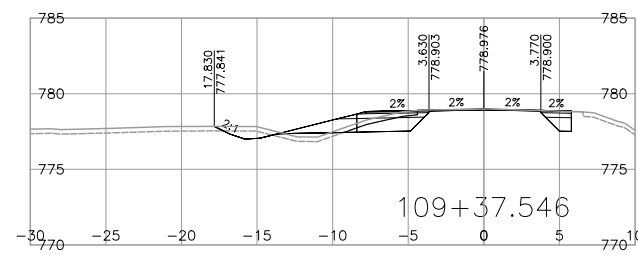
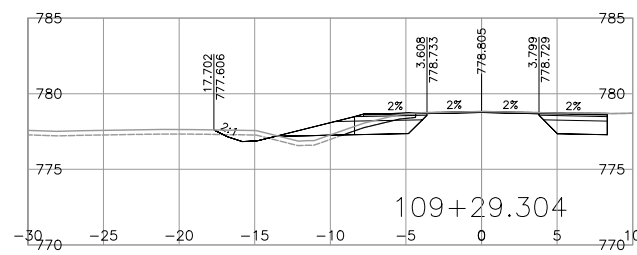
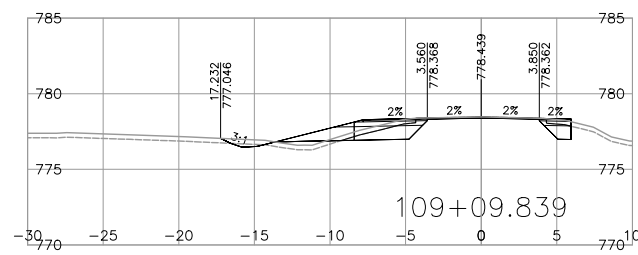
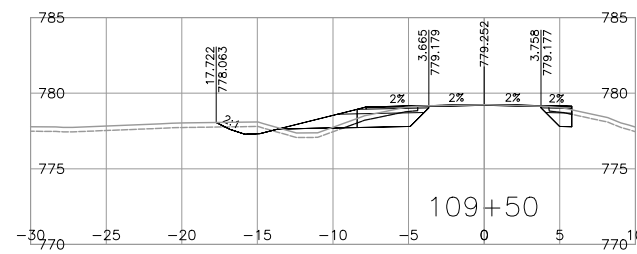
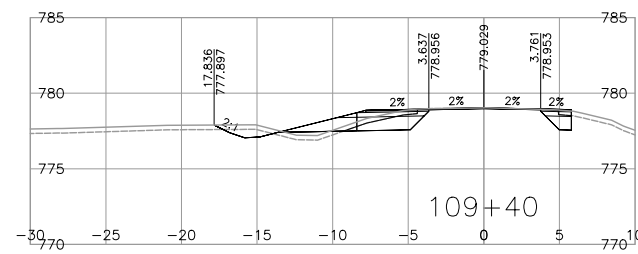
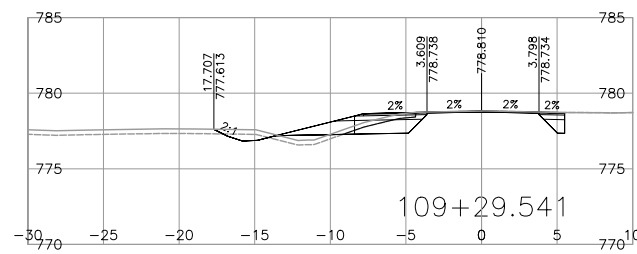
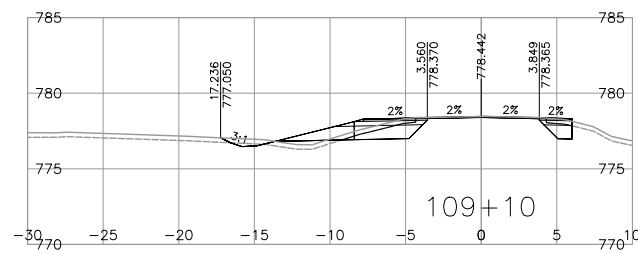
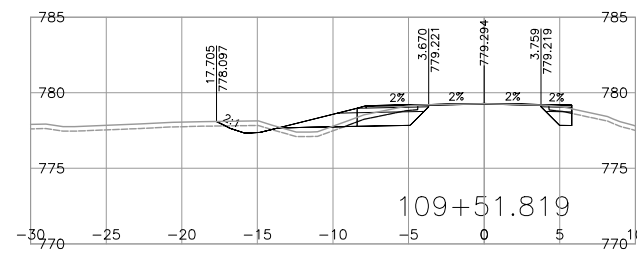
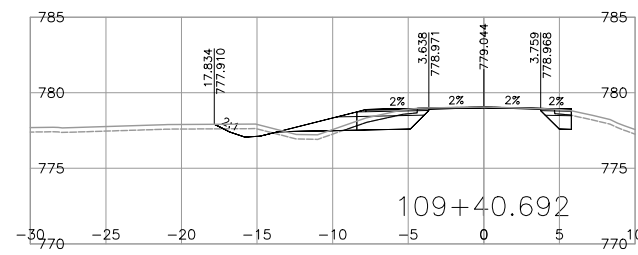
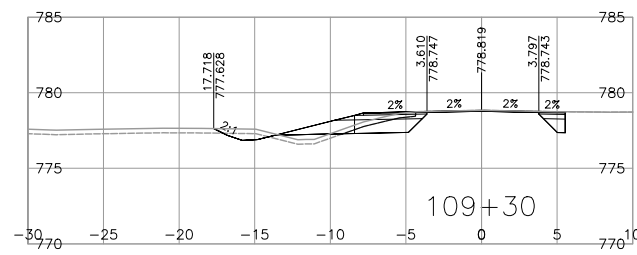
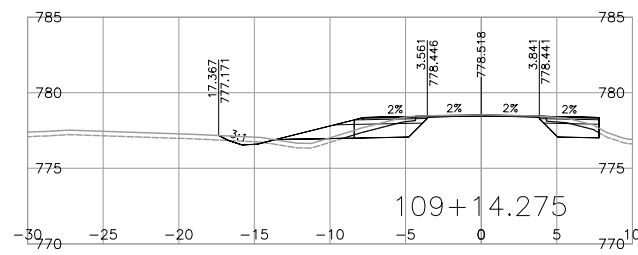
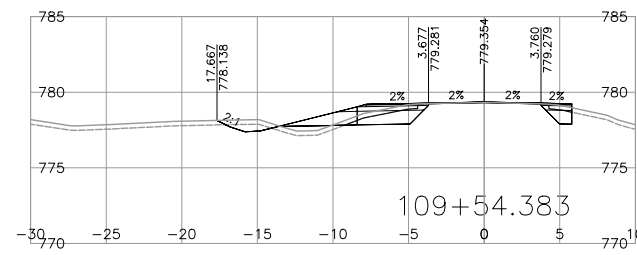
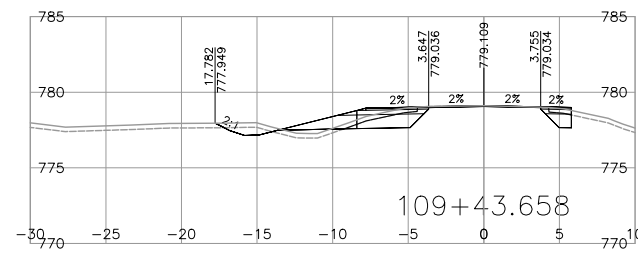
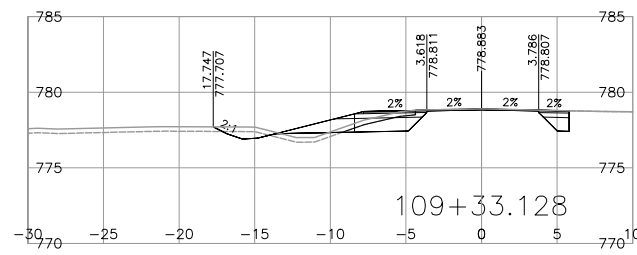
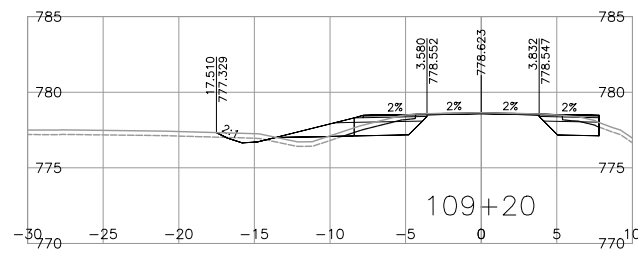

NOTE: STRIPPING REMOVAL APPLIES ONLY TO THE AREA BETWEEN SLOPE STAKE LINES (TOES & TOP OF CUT) OF PROPOSED ROADWAY TEMPLATE

FOR REFERENCE ONLY

DRAFT

FOR INFORMATION ONLY MARCH 03, 2023

R.F. BINNIE & ASSOCIATES LTD.
101 - 1577 7th Avenue,
Prince George, BC V2L 3P5
TEL 250 561 7274
BINNIE.com

MINISTRY OF TRANSPORTATION
AND INFRASTRUCTURE
NORTHERN REGION
HIGHWAY ENGINEERING AND GEOMATICS

SCALE CAD FILENAME 21-0125-1000XS-1-100A1.DWG
DATE 2023-03-01
FILE NUMBER 21-0125-00

REV	DATE	REVISIONS	SIGNATURE

L100A1-LINE CROSS SECTIONS
HIGHWAY 16
GUEST ROAD AND SHALLOW BAY ROAD INTERSECTIONS

DESIGNED _____ R.M. DATE MAR. 2023
QUALITY CONTROL _____ K.T. DATE MAR. 2023
QUALITY ASSURANCE _____ R.M. DATE MAR. 2023
DRAWN _____ J.D. DATE MAR. 2023

PROJECT NUMBER 38199-0000 REG 3 DRAWING NUMBER -L100A1-14XS REV _____

R. Mankowske
ENGINEER OF RECORD
DATE 20230303

Mar. 1, 2023 - 11:24 AM P:\2021\21-0125-00 - CAD Files\CAD-Files\H1-Drawing\Production\000_Design\Sections\1-0125-1000XS-L100A1

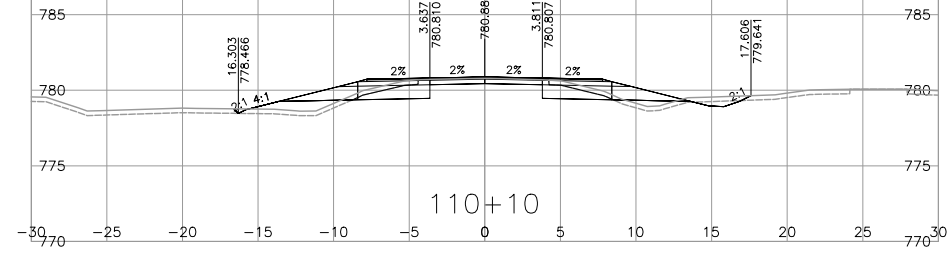
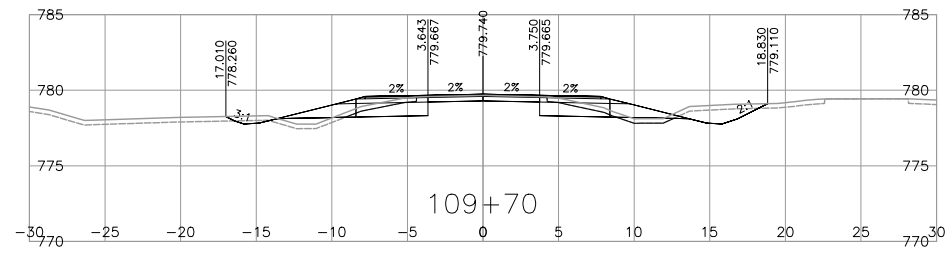
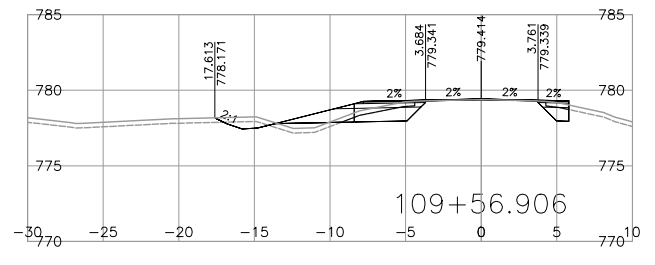
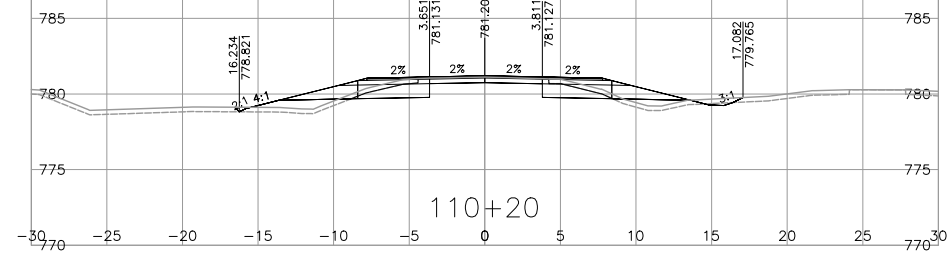
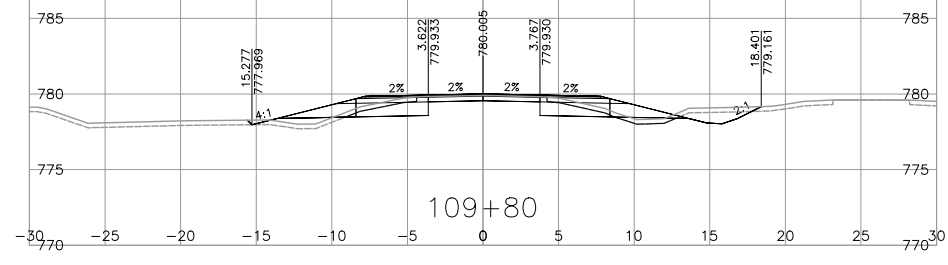
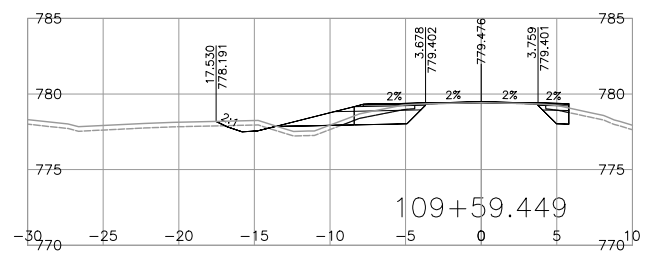
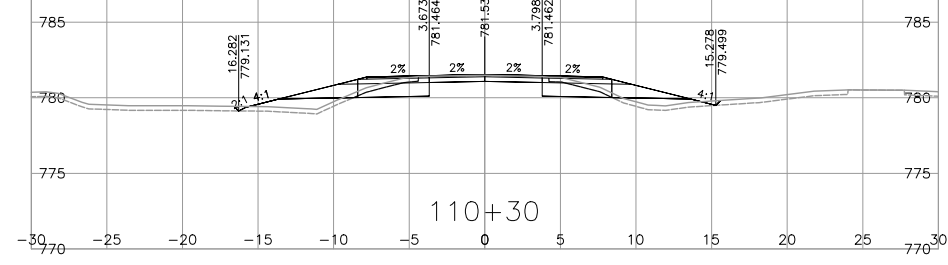
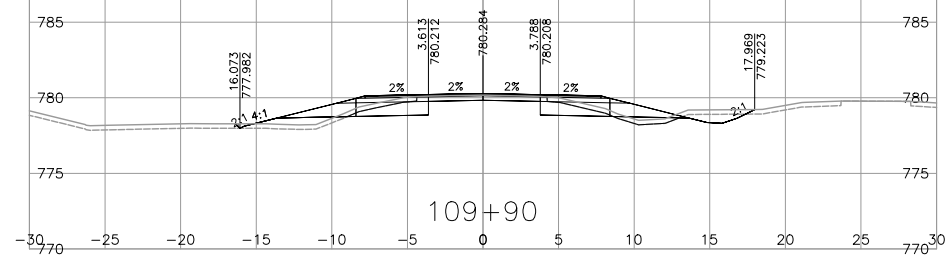
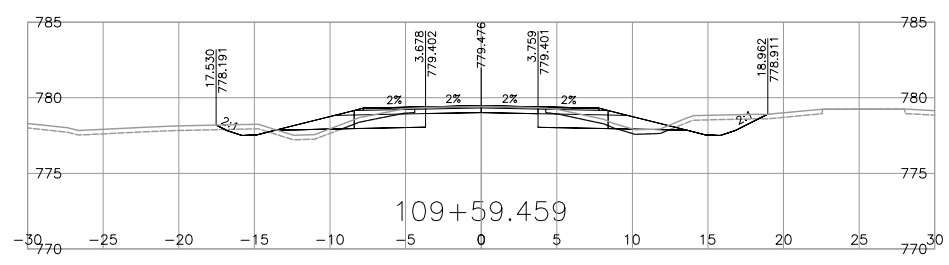
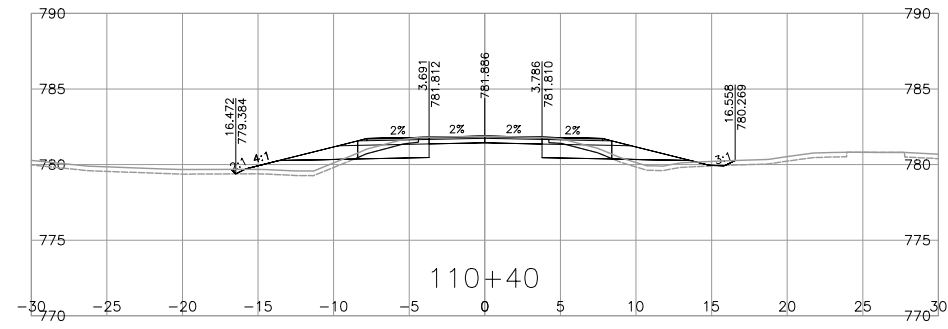
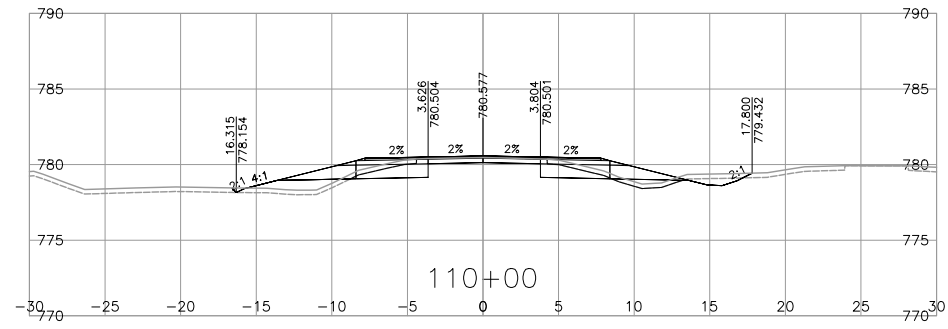
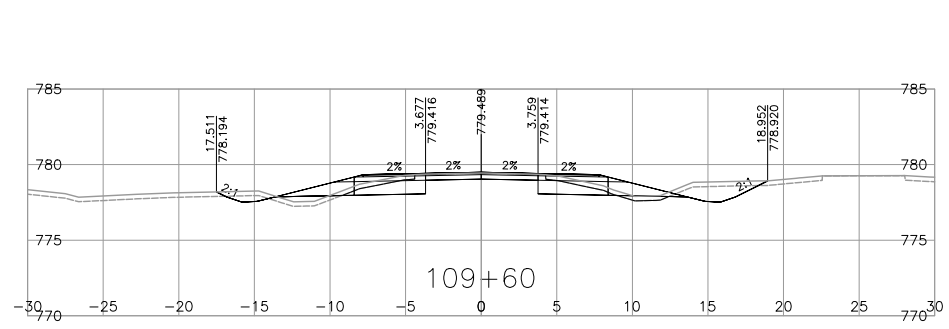

NOTE: STRIPPING REMOVAL APPLIES ONLY TO THE AREA BETWEEN SLOPE STAKE LINES (TOES & TOP OF CUT) OF PROPOSED ROADWAY TEMPLATE

FOR REFERENCE ONLY

DRAFT

FOR INFORMATION ONLY MARCH 03, 2023

<p>BINNIE The people behind your infrastructure.</p>	<p>R.F. BINNIE & ASSOCIATES LTD. 101 - 1577 7th Avenue, Prince George, BC V2L 3P5 TEL 250 561 7274 BINNIE.com</p>	<p>BRITISH COLUMBIA</p>	<p>MINISTRY OF TRANSPORTATION AND INFRASTRUCTURE NORTHERN REGION HIGHWAY ENGINEERING AND GEOMATICS</p>																																																				
				<p>L100A1-LINE CROSS SECTIONS HIGHWAY 16 GUEST ROAD AND SHALLOW BAY ROAD INTERSECTIONS</p>																																																			
<p>SCALE CAD FILENAME <u>21-0125-1000XS-L100A1.DWG</u> DATE <u>2023-03-01</u> FILE NUMBER <u>21-0125-00</u></p>		<table border="1"> <tr> <td>DESIGNED</td> <td>_____</td> <td>R.M.</td> <td>DATE</td> <td><u>MAR. 2023</u></td> </tr> <tr> <td>QUALITY CONTROL</td> <td>_____</td> <td>K.T.</td> <td>DATE</td> <td><u>MAR. 2023</u></td> </tr> <tr> <td>QUALITY ASSURANCE</td> <td>_____</td> <td>R.M.</td> <td>DATE</td> <td><u>MAR. 2023</u></td> </tr> <tr> <td>DRAWN</td> <td>_____</td> <td>J.D.</td> <td>DATE</td> <td><u>MAR. 2023</u></td> </tr> </table>		DESIGNED	_____	R.M.	DATE	<u>MAR. 2023</u>	QUALITY CONTROL	_____	K.T.	DATE	<u>MAR. 2023</u>	QUALITY ASSURANCE	_____	R.M.	DATE	<u>MAR. 2023</u>	DRAWN	_____	J.D.	DATE	<u>MAR. 2023</u>																																
DESIGNED	_____	R.M.	DATE	<u>MAR. 2023</u>																																																			
QUALITY CONTROL	_____	K.T.	DATE	<u>MAR. 2023</u>																																																			
QUALITY ASSURANCE	_____	R.M.	DATE	<u>MAR. 2023</u>																																																			
DRAWN	_____	J.D.	DATE	<u>MAR. 2023</u>																																																			
<table border="1"> <thead> <tr> <th>REV</th> <th>DATE</th> <th>REVISIONS</th> <th>SIGNATURE</th> </tr> </thead> <tbody> <tr><td> </td><td> </td><td> </td><td> </td></tr> <tr><td> </td><td> </td><td> </td><td> </td></tr> <tr><td> </td><td> </td><td> </td><td> </td></tr> <tr><td> </td><td> </td><td> </td><td> </td></tr> <tr><td> </td><td> </td><td> </td><td> </td></tr> <tr><td> </td><td> </td><td> </td><td> </td></tr> <tr><td> </td><td> </td><td> </td><td> </td></tr> <tr><td> </td><td> </td><td> </td><td> </td></tr> <tr><td> </td><td> </td><td> </td><td> </td></tr> <tr><td> </td><td> </td><td> </td><td> </td></tr> </tbody> </table>		REV	DATE	REVISIONS	SIGNATURE																																									<p>R. Mankowske ENGINEER OF RECORD DATE 20230303</p> <table border="1"> <tr> <td>PROJECT NUMBER</td> <td>38199-0000</td> <td>REG</td> <td>3</td> <td>DRAWING NUMBER</td> <td>-L100A1-15XS</td> <td>REV</td> <td> </td> </tr> </table>		PROJECT NUMBER	38199-0000	REG	3	DRAWING NUMBER	-L100A1-15XS	REV	
REV	DATE	REVISIONS	SIGNATURE																																																				
PROJECT NUMBER	38199-0000	REG	3	DRAWING NUMBER	-L100A1-15XS	REV																																																	

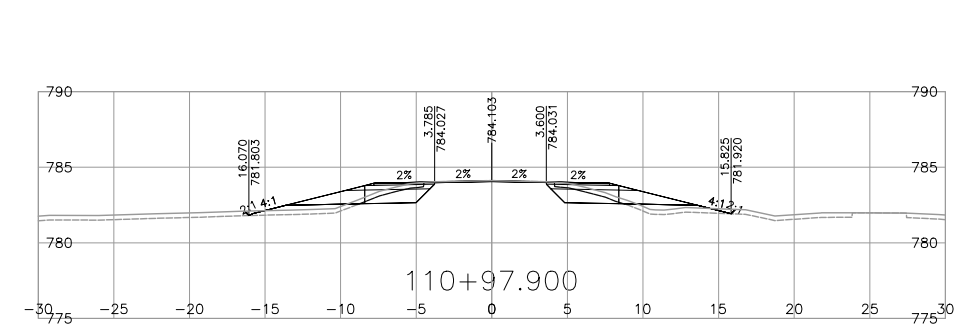
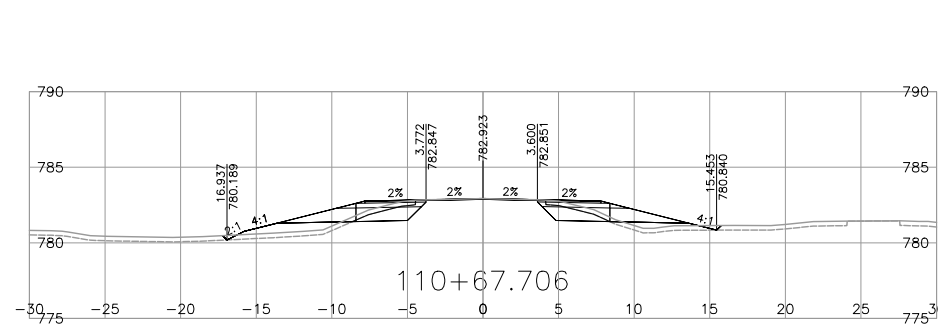
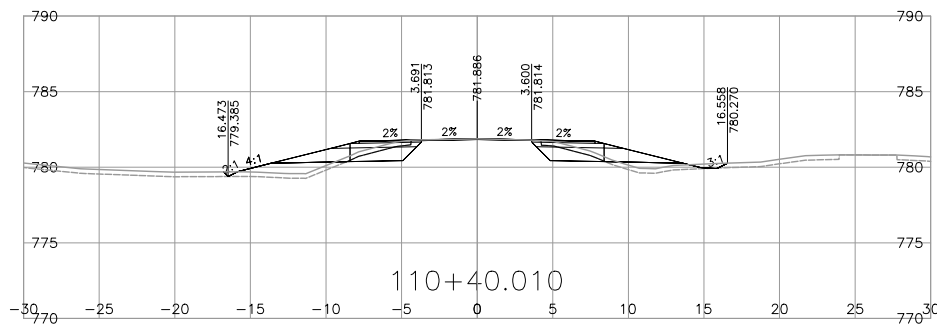
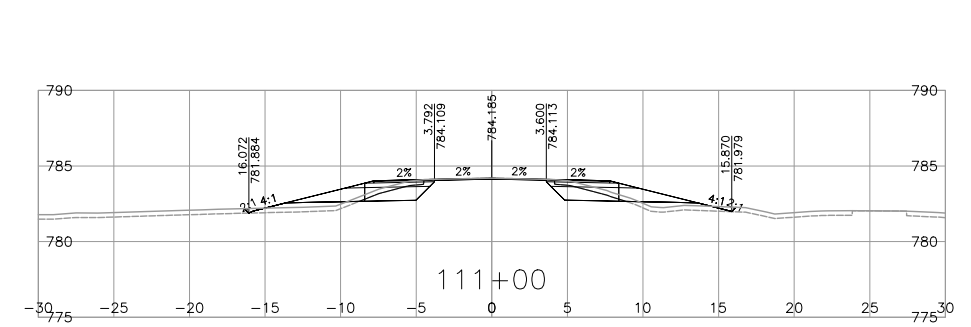
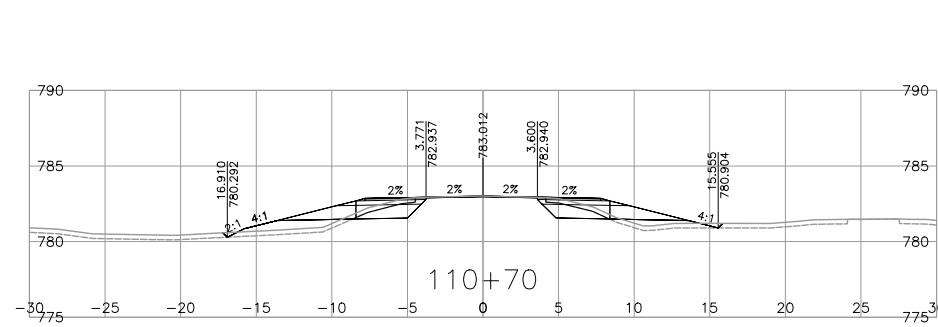
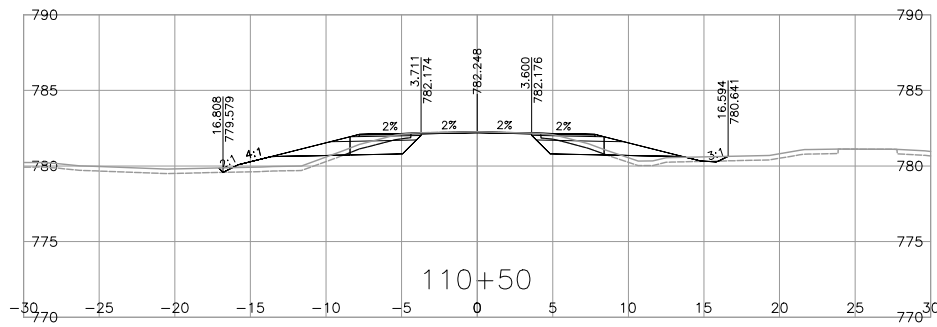
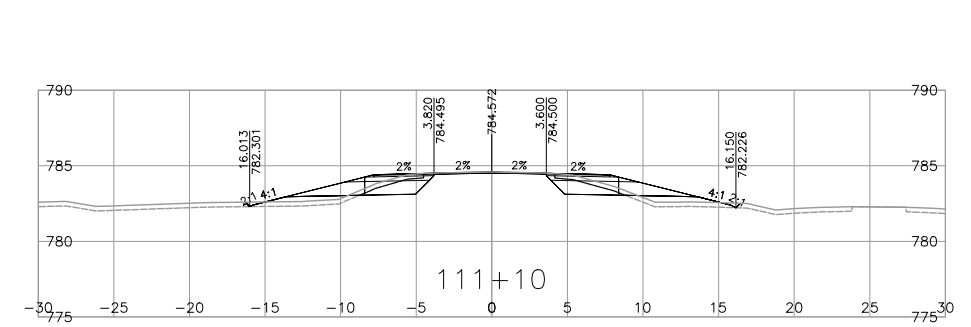
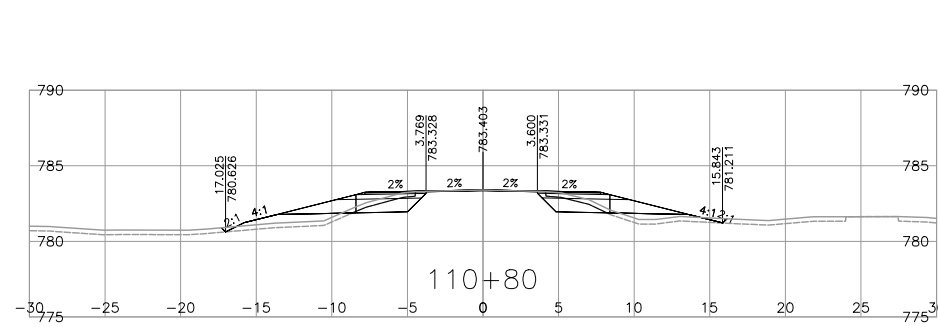
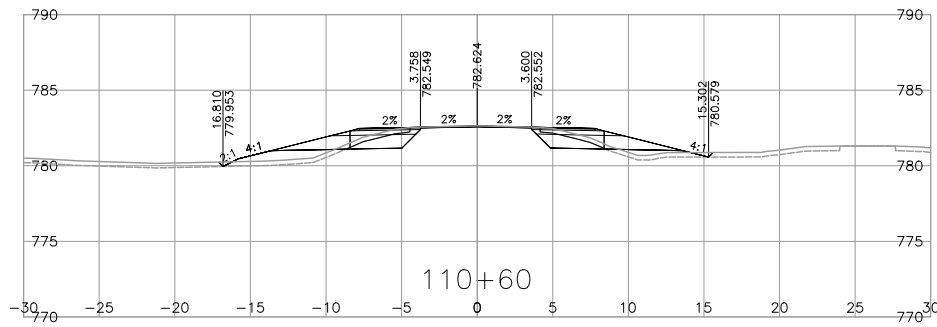
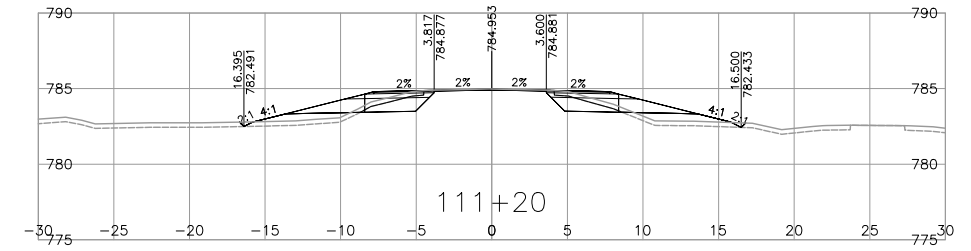
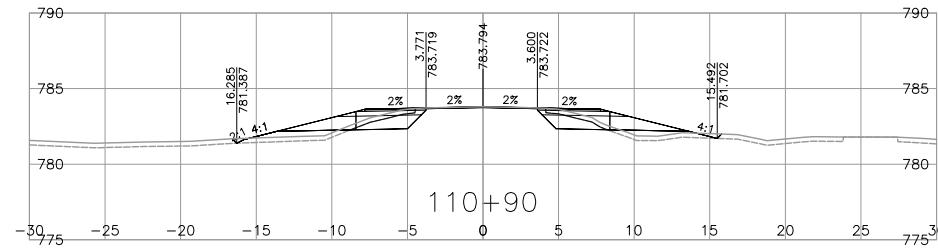
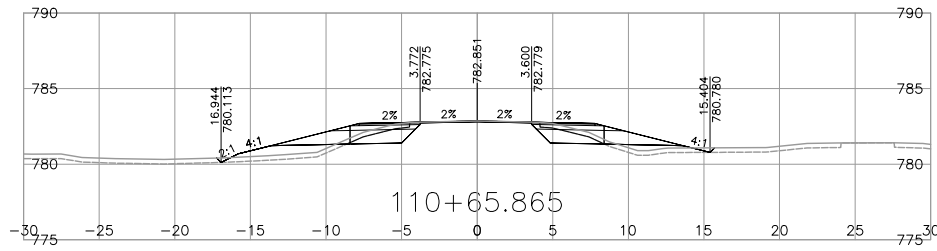

NOTE: STRIPPING REMOVAL APPLIES ONLY TO THE AREA BETWEEN SLOPE STAKE LINES (TOES & TOP OF CUT) OF PROPOSED ROADWAY TEMPLATE

FOR REFERENCE ONLY

DRAFT

FOR INFORMATION ONLY MARCH 03, 2023

BINNIE
The people behind your infrastructure.

R.F. BINNIE & ASSOCIATES LTD.
101 - 1577 7th Avenue,
Prince George, BC V2L 3P5
TEL 250 561 7274
BINNIE.com

BRITISH COLUMBIA
MINISTRY OF TRANSPORTATION AND INFRASTRUCTURE
NORTHERN REGION
HIGHWAY ENGINEERING AND GEOMATICS

L100A1-LINE CROSS SECTIONS
HIGHWAY 16
GUEST ROAD AND SHALLOW BAY ROAD INTERSECTIONS

SCALE

REV	DATE	REVISIONS	SIGNATURE

CAD FILENAME: 21-0125-1000XS-1-100A1.DWG
DATE: 2023-03-01
FILE NUMBER: 21-0125-00

R. Mankowske
ENGINEER OF RECORD
DATE: 20230303

DESIGNED	_____	R.M.	DATE	MAR. 2023
QUALITY CONTROL	_____	K.T.	DATE	MAR. 2023
QUALITY ASSURANCE	_____	R.M.	DATE	MAR. 2023
DRAWN	_____	J.D.	DATE	MAR. 2023
PROJECT NUMBER	38199-0000	REG	3	DRAWING NUMBER
				-L100A1-16XS

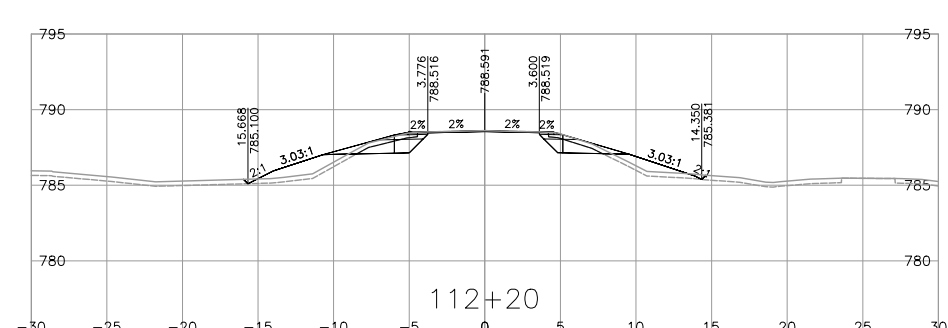
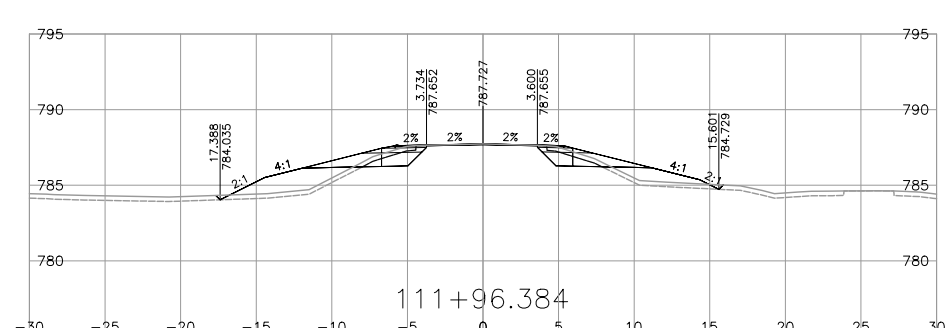
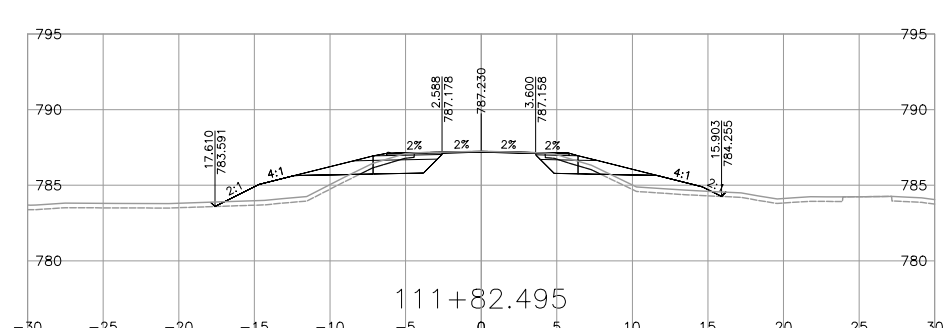
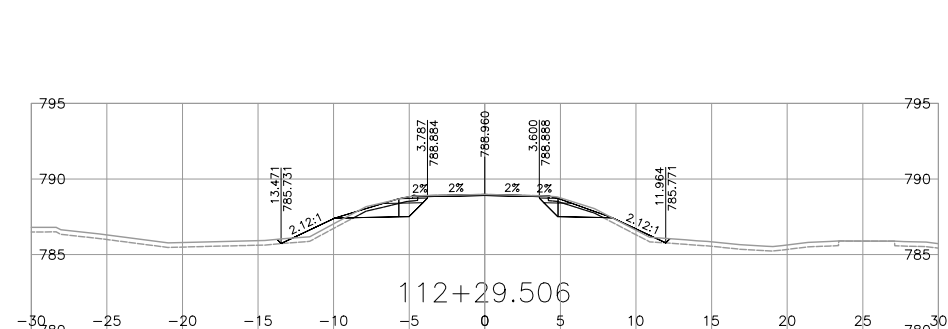
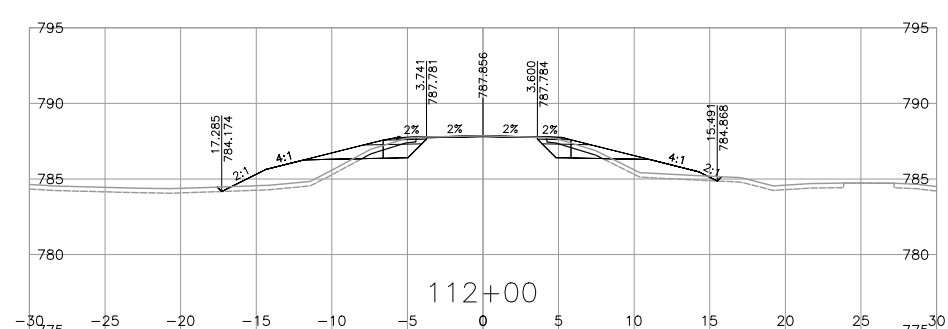
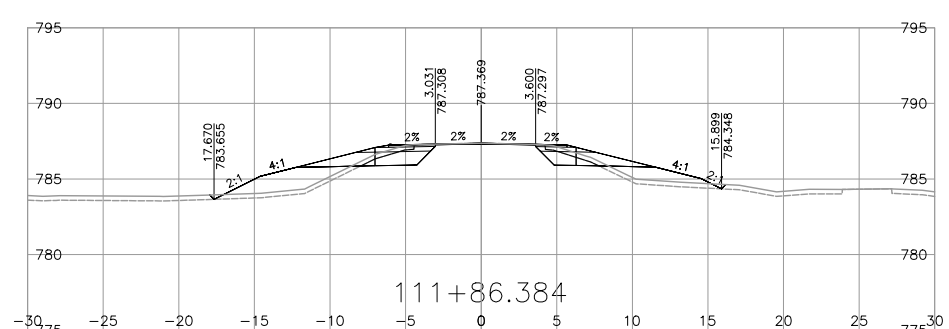
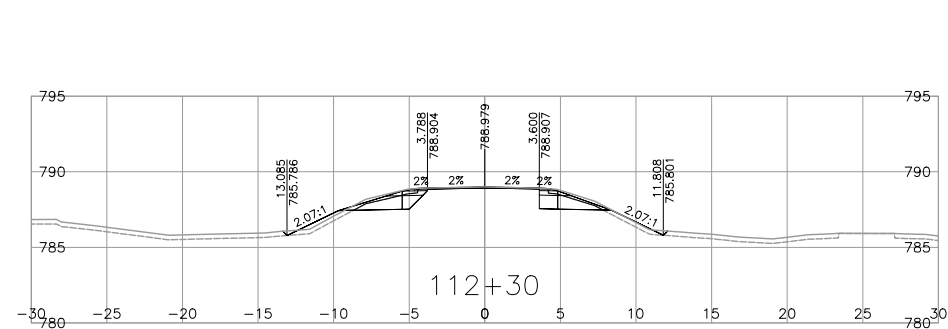
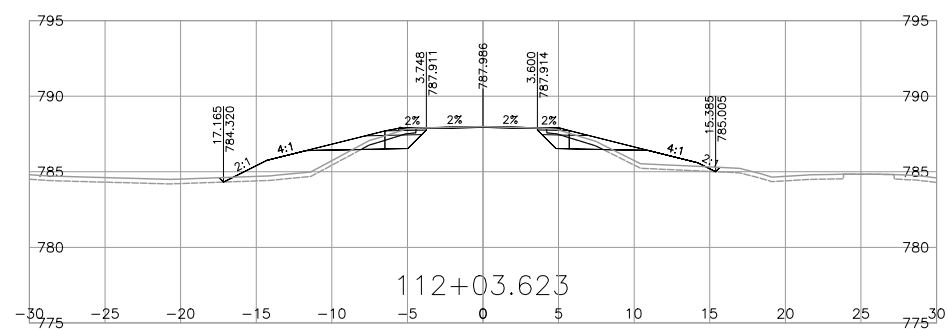
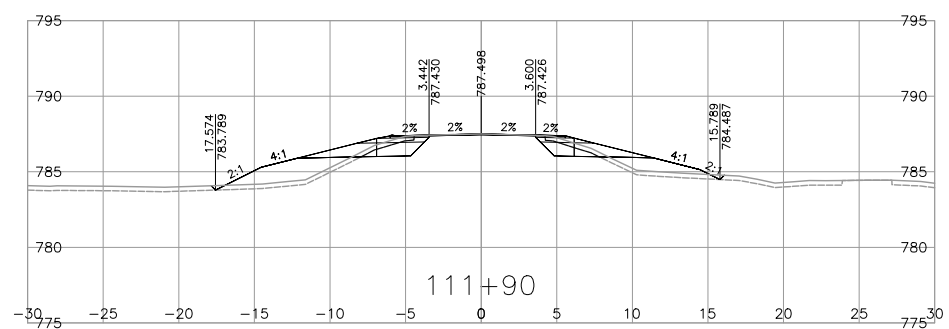
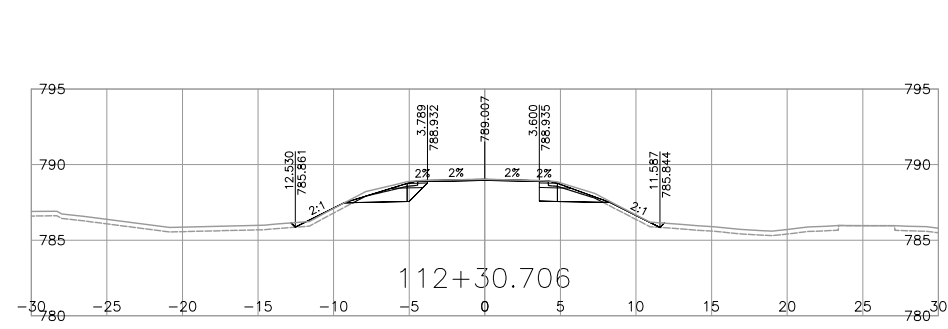
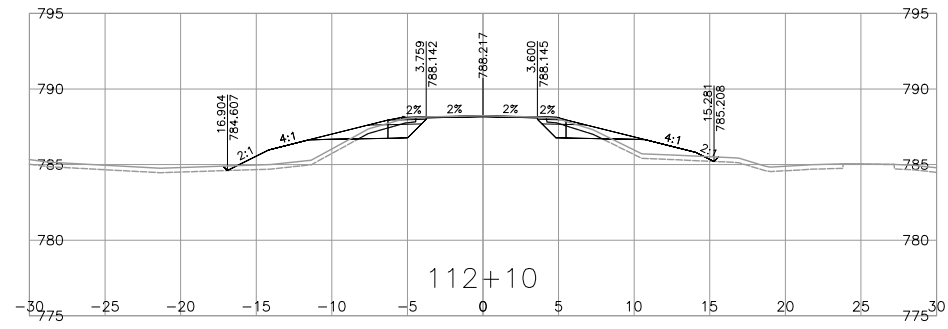
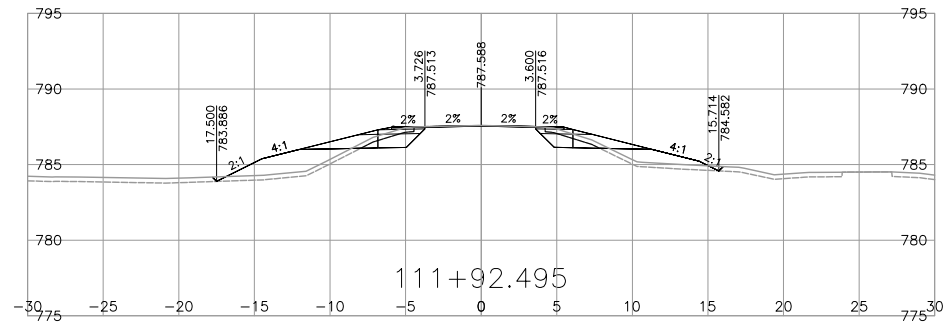

NOTE: STRIPPING REMOVAL APPLIES ONLY TO THE AREA BETWEEN SLOPE STAKE LINES (TOES & TOP OF CUT) OF PROPOSED ROADWAY TEMPLATE

FOR REFERENCE ONLY

DRAFT

FOR INFORMATION ONLY MARCH 03, 2023

R.F. BINNIE & ASSOCIATES LTD.
101 - 1577 7th Avenue,
Prince George, BC V2L 3P5
TEL 250 561 7274
BINNIE.com

MINISTRY OF TRANSPORTATION
AND INFRASTRUCTURE
NORTHERN REGION
HIGHWAY ENGINEERING AND GEOMATICS

L100A1-LINE CROSS SECTIONS
HIGHWAY 16
GUEST ROAD AND SHALLOW BAY ROAD INTERSECTIONS

SCALE: 0 2 1:250 12m CAD FILENAME: 21-0125-1000XS-1-100A1.DWG DATE: 2023-03-01 FILE NUMBER: 21-0125-00

REV	DATE	REVISIONS	SIGNATURE

R. Mankowske
ENGINEER OF RECORD
DATE 20230303

DESIGNED	_____	R.M.	DATE	MAR 2023
QUALITY CONTROL	_____	K.T.I.	DATE	MAR 2023
QUALITY ASSURANCE	_____	R.M.	DATE	MAR 2023
DRAWN	_____	J.D.	DATE	MAR 2023
PROJECT NUMBER	38199-0000	REG	3	DRAWING NUMBER
				-L100A1-18XS

Mar 1, 2023 - 11:24 AM P:\2021\21-0125-00 - CAD Files\CAD\H1\Drawings\Production\1000_Design\Sections\1-0125-1000XS-L100A1

Mar. 1, 2023 - 11:13 AM P:\2021\21-0125-00 - CAD Files\CAD\H1\Drawings\Production\000_Design\Sections\0125-1000XSL300A2

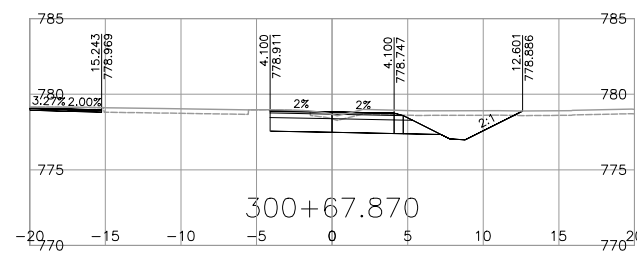
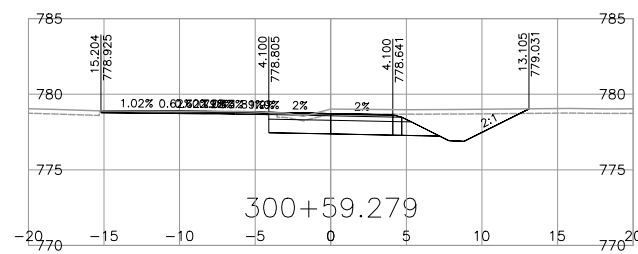
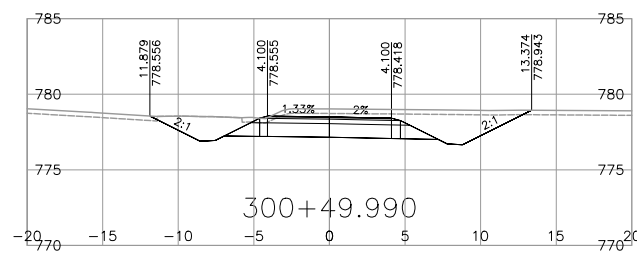
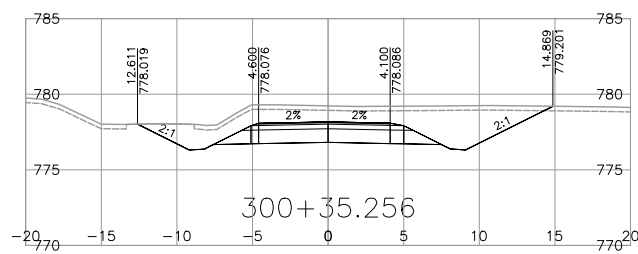
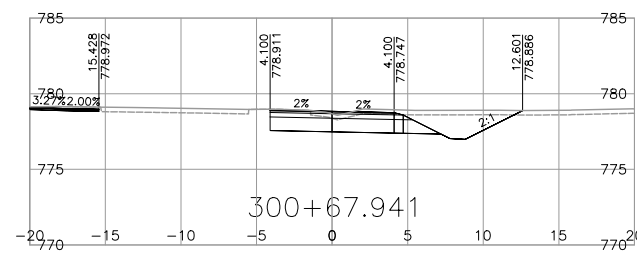
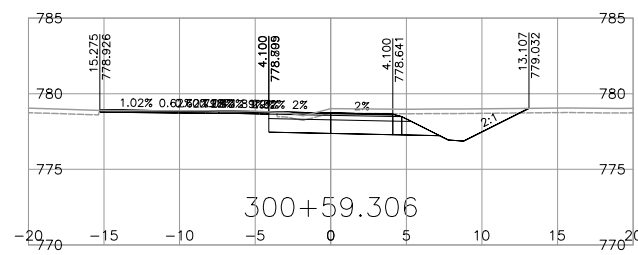
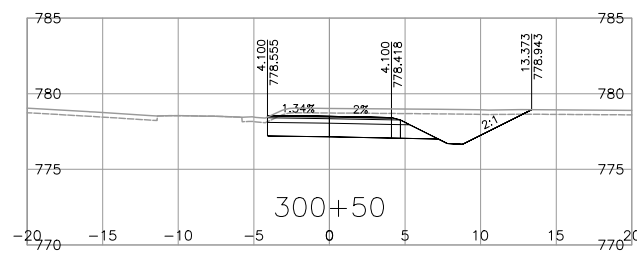
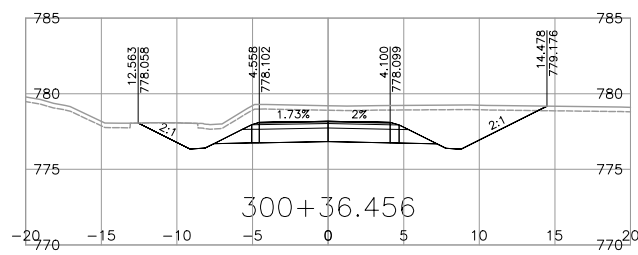
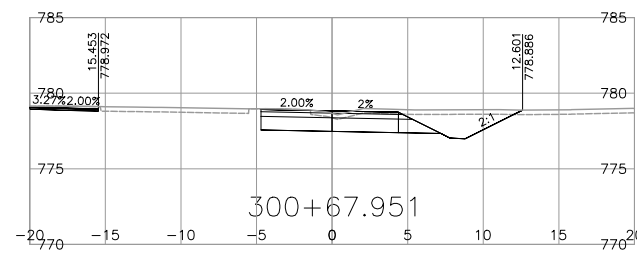
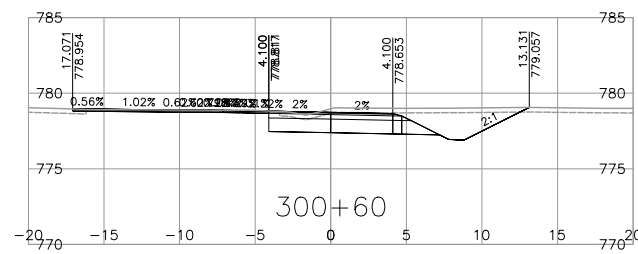
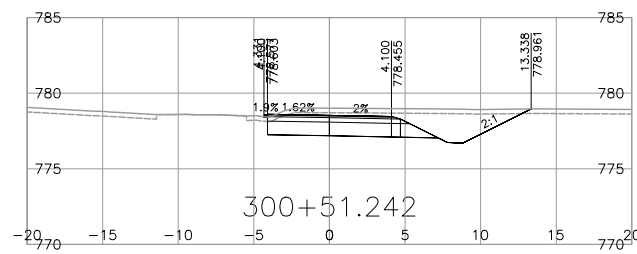
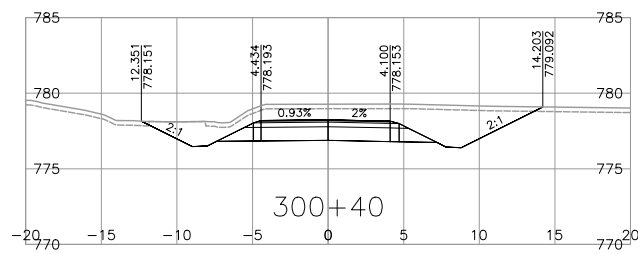
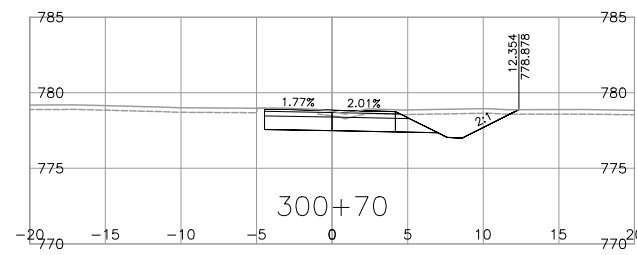
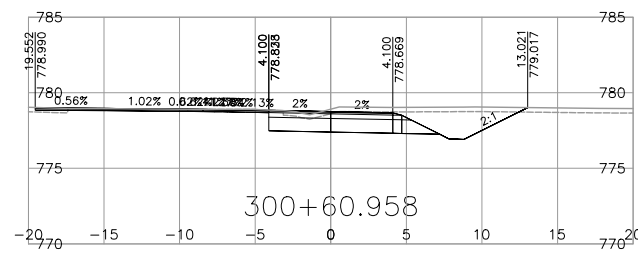
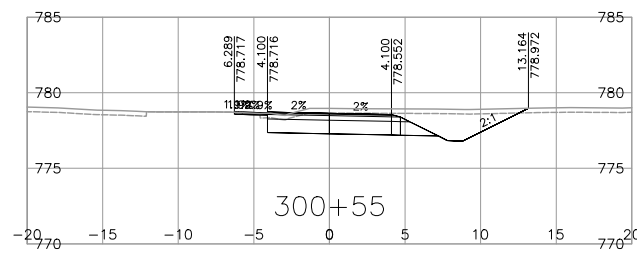
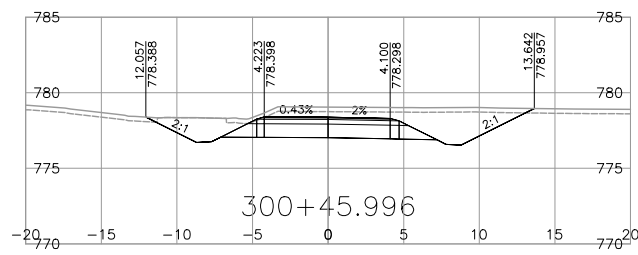
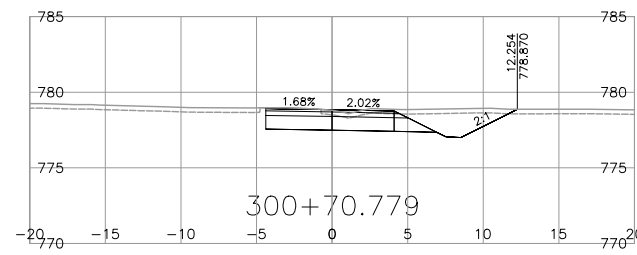
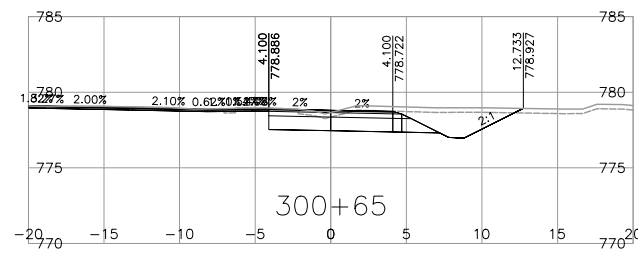
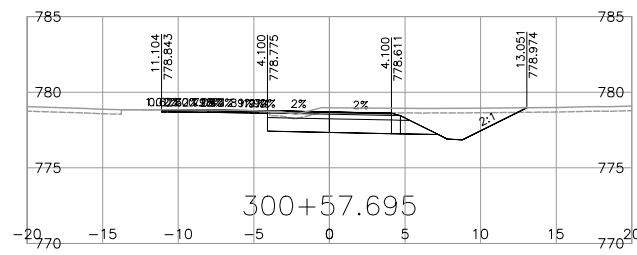
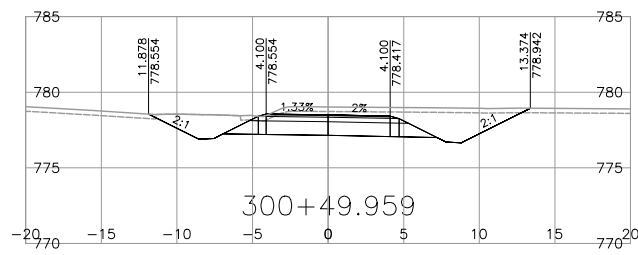

NOTE: STRIPPING REMOVAL APPLIES ONLY TO THE AREA BETWEEN SLOPE STAKE LINES (TOES & TOP OF CUT) OF PROPOSED ROADWAY TEMPLATE

FOR REFERENCE ONLY

DRAFT

FOR INFORMATION ONLY MARCH 03, 2023

<p>BINNIE The people behind your infrastructure.</p>		<p>R.F. BINNIE & ASSOCIATES LTD. 300 - 4940 Canada Way, Burnaby, BC V5G 4K6 TEL 604 420 1721 BINNIE.com</p>		<p>BRITISH COLUMBIA</p>		<p>MINISTRY OF TRANSPORTATION AND INFRASTRUCTURE SOUTH COAST REGION HIGHWAY ENGINEERING AND GEOMATICS</p>																																											
<p>SCALE </p>		<p>CAD FILENAME: 21-0125-1000XS-1300A2.DWG DATE: 2023-03-01 FILE NUMBER: 21-0125-00</p>		<p>L300-LINE CROSS SECTIONS HIGHWAY 16 GUEST ROAD AND SHALLOW BAY ROAD INTERSECTIONS</p>																																													
<table border="1"> <thead> <tr> <th>REV</th> <th>DATE</th> <th>REVISIONS</th> <th>SIGNATURE</th> </tr> </thead> <tbody> <tr><td> </td><td> </td><td> </td><td> </td></tr> <tr><td> </td><td> </td><td> </td><td> </td></tr> <tr><td> </td><td> </td><td> </td><td> </td></tr> <tr><td> </td><td> </td><td> </td><td> </td></tr> <tr><td> </td><td> </td><td> </td><td> </td></tr> </tbody> </table>		REV	DATE	REVISIONS	SIGNATURE																					<p>R. Mankowske ENGINEER OF RECORD DATE 20230303</p>		<table border="1"> <tr> <td>DESIGNED</td> <td>_____</td> <td>R.M.</td> <td>DATE</td> <td>MAR. 2023</td> </tr> <tr> <td>QUALITY CONTROL</td> <td>_____</td> <td>K.T.</td> <td>DATE</td> <td>MAR. 2023</td> </tr> <tr> <td>QUALITY ASSURANCE</td> <td>_____</td> <td>R.M.</td> <td>DATE</td> <td>MAR. 2023</td> </tr> <tr> <td>DRAWN</td> <td>_____</td> <td>J.D.</td> <td>DATE</td> <td>MAR. 2023</td> </tr> </table>		DESIGNED	_____	R.M.	DATE	MAR. 2023	QUALITY CONTROL	_____	K.T.	DATE	MAR. 2023	QUALITY ASSURANCE	_____	R.M.	DATE	MAR. 2023	DRAWN	_____	J.D.	DATE	MAR. 2023
REV	DATE	REVISIONS	SIGNATURE																																														
DESIGNED	_____	R.M.	DATE	MAR. 2023																																													
QUALITY CONTROL	_____	K.T.	DATE	MAR. 2023																																													
QUALITY ASSURANCE	_____	R.M.	DATE	MAR. 2023																																													
DRAWN	_____	J.D.	DATE	MAR. 2023																																													
<p>PROJECT NUMBER: 38199-0000</p>		<p>REG: 3</p>		<p>DRAWING NUMBER: -L300-1XS</p>		<p>REV: _____</p>																																											

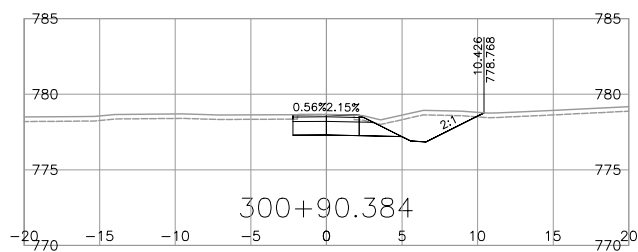
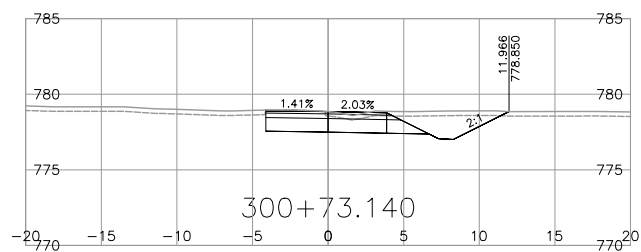
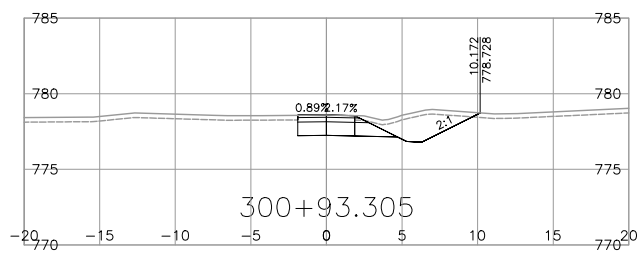
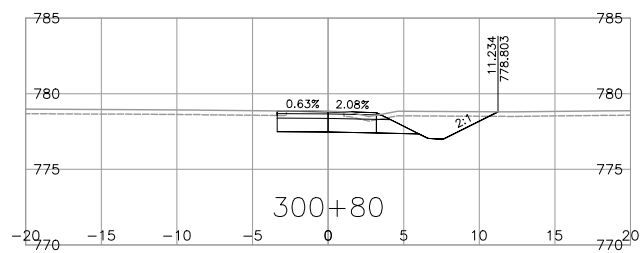
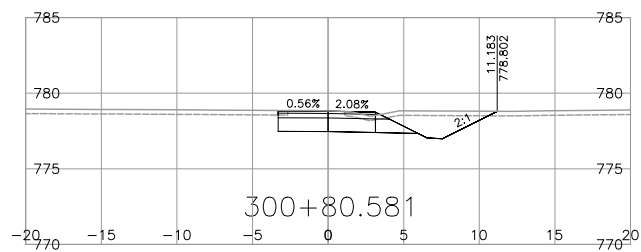
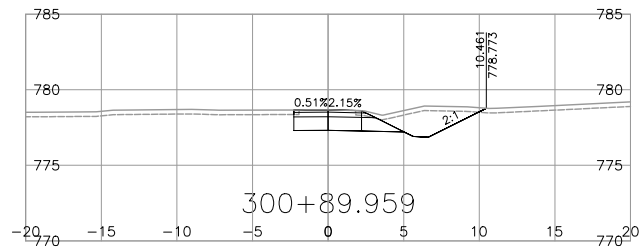
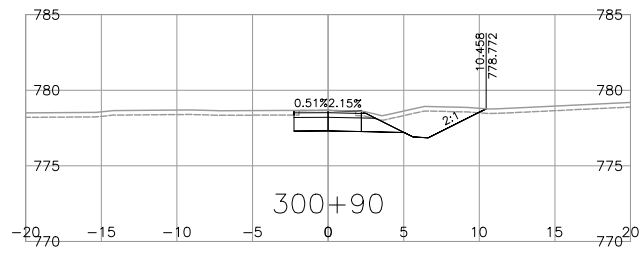

NOTE: STRIPPING REMOVAL APPLIES ONLY TO THE AREA BETWEEN SLOPE STAKE LINES (TOES & TOP OF CUT) OF PROPOSED ROADWAY TEMPLATE

FOR REFERENCE ONLY

DRAFT

FOR INFORMATION ONLY MARCH 03, 2023

Mar. 1, 2023 - 11:13 AM P:\2021\21-0125-00 - CAD Files\CAD\H1\CrossSection\H1\Drawings\Production\000_Design\Section\21-0125-1000XSL300A2

		R.F. BINNIE & ASSOCIATES LTD. 300 - 4940 Canada Way, Burnaby, BC V5G 4K6 TEL 604 420 1721 BINNIE.com				MINISTRY OF TRANSPORTATION AND INFRASTRUCTURE SOUTH COAST REGION HIGHWAY ENGINEERING AND GEOMATICS	
SCALE		CAD FILENAME <u>21-0125-1000XS-L300A2.DWG</u> DATE <u>2023-03-01</u> FILE NUMBER <u>21-0125-00</u>		L300-LINE CROSS SECTIONS HIGHWAY 16 GUEST ROAD AND SHALLOW BAY ROAD INTERSECTIONS			
REV	DATE	REVISIONS	SIGNATURE	DESIGNED _____ R.M. DATE <u>MAR_2023</u> QUALITY CONTROL _____ K.T. DATE <u>MAR_2023</u> QUALITY ASSURANCE _____ R.M. DATE <u>MAR_2023</u> DRAWN _____ J.D. DATE <u>MAR_2023</u>		PROJECT NUMBER <u>38199-0000</u> REG <u>3</u> DRAWING NUMBER <u>-L300-2XS</u>	
R. Mankowske ENGINEER OF RECORD DATE 20230303							

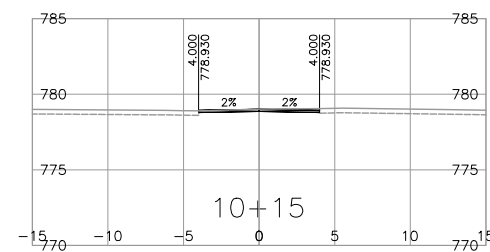
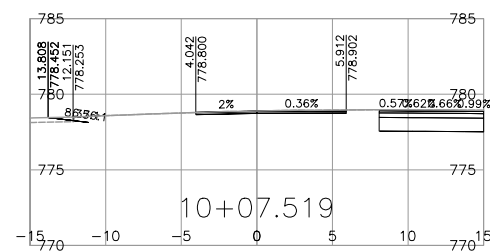
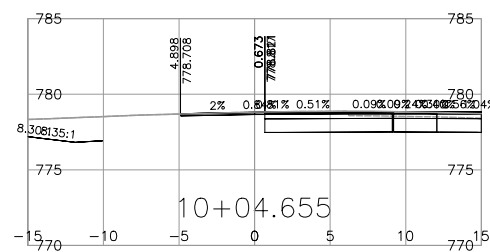
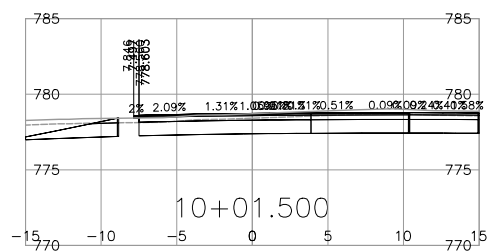
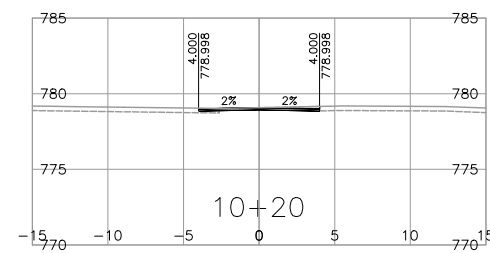
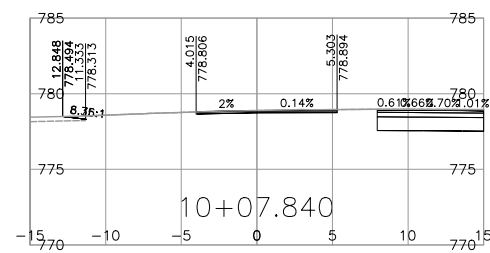
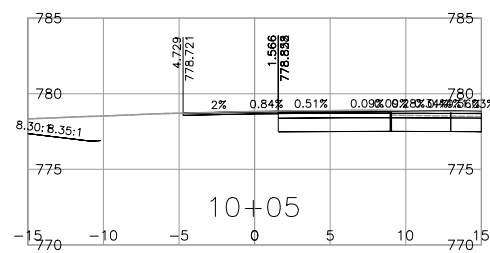
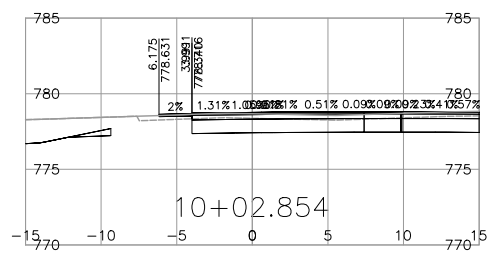
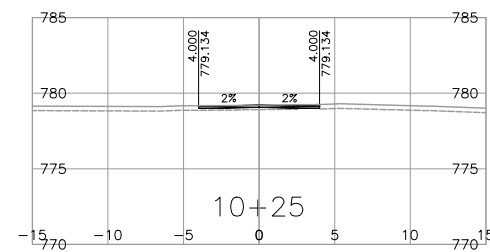
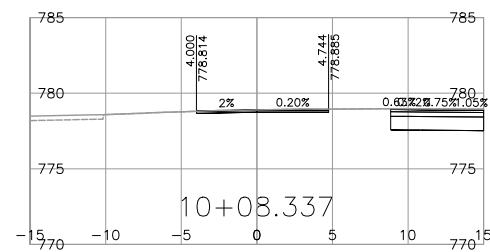
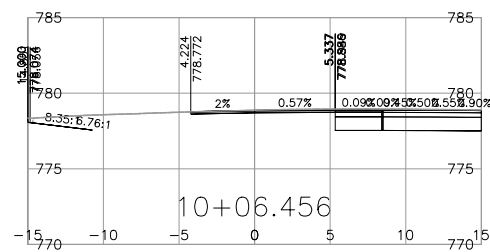
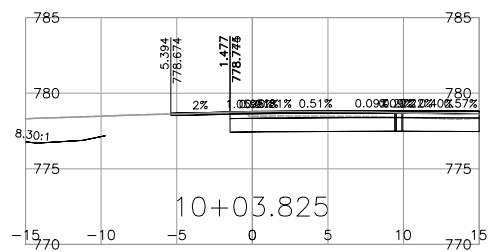
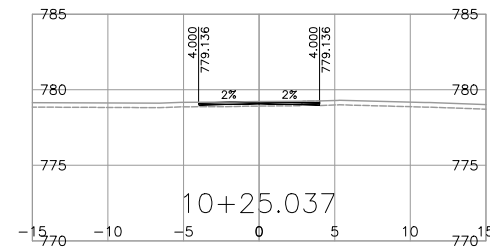
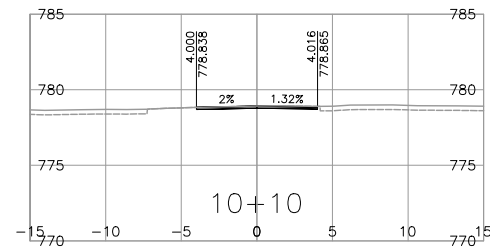
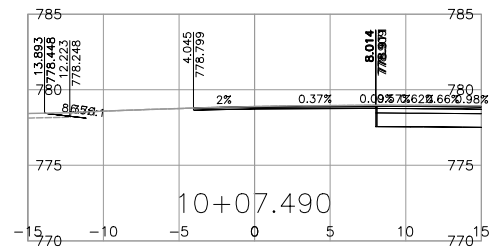
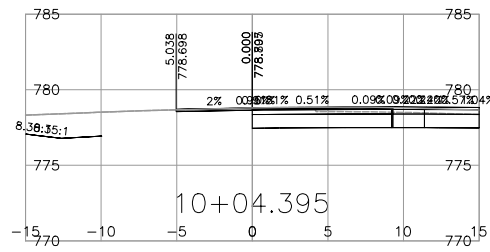
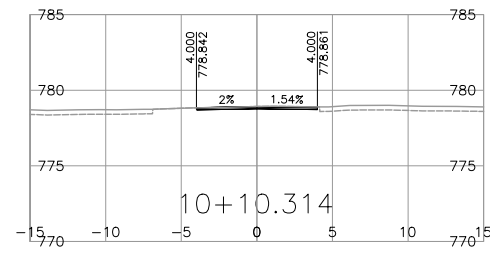
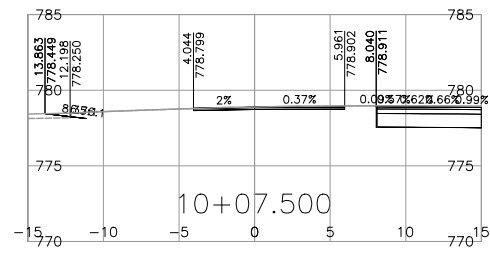
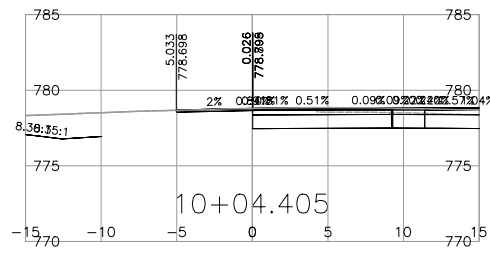

NOTE: STRIPPING REMOVAL APPLIES ONLY TO THE AREA BETWEEN SLOPE STAKE LINES (TOES & TOP OF CUT) OF PROPOSED ROADWAY TEMPLATE

FOR REFERENCE ONLY

DRAFT

FOR INFORMATION ONLY MARCH 03, 2023

BINNIE
The people behind your infrastructure.

R.F. BINNIE & ASSOCIATES LTD.
300 - 4940 Canada Way,
Burnaby, BC V5G 4K6
TEL 604 420 1721
BINNIE.com

BRITISH COLUMBIA
MINISTRY OF TRANSPORTATION AND INFRASTRUCTURE
SOUTH COAST REGION
HIGHWAY ENGINEERING AND GEOMATICS

SCALE 0 2 1:250 12m
CAD FILENAME 21-0125-1000XS-4300A2.DWG
DATE 2023-03-01
FILE NUMBER 21-0125-00

DRAWING TYPE
HIGHWAY 16
GUEST ROAD AND SHALLOW BAY ROAD INTERSECTIONS

REV	DATE	REVISIONS	SIGNATURE

DESIGNED	J.D.	DATE	MAR 2023
QUALITY CONTROL	R.M.	DATE	MAR 2023
QUALITY ASSURANCE	M.C.	DATE	MAR 2023
DRAWN	I.C.	DATE	MAR 2023
PROJECT NUMBER	REG	DRAWING NUMBER	REV
38199-0000	NOT	USE THIS FIELD	L300-3XS

R. Mankowske
ENGINEER OF RECORD
DATE 20230303

Mar 1, 2023 - 11:13 AM P:\2021\21-0125-00 - CAD Files\CAD-Highway\Hwy16\Drawings\Production\1000 - Drawings\Sections\0125-1000XS-L300-2

Mar. 1, 2023 - 11:11 AM P:\2021\21-0125-00 - CAD Files\CAD-Highway\Production\000_Design\Sections\0125-1000XSL400Z.dwg

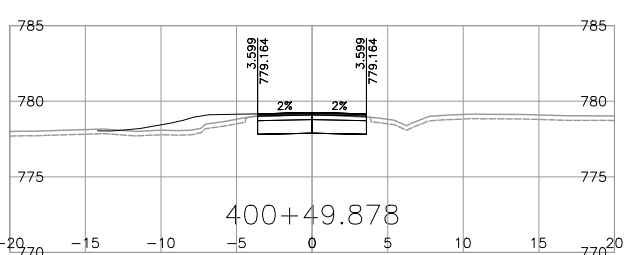
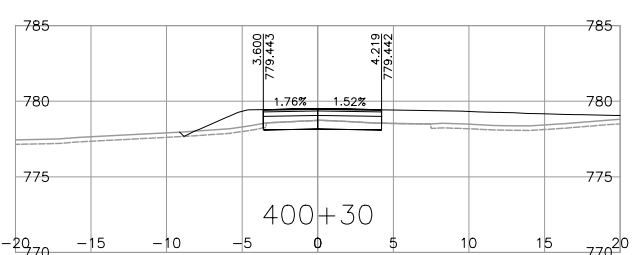
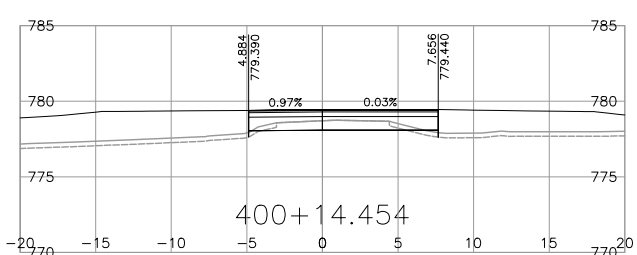
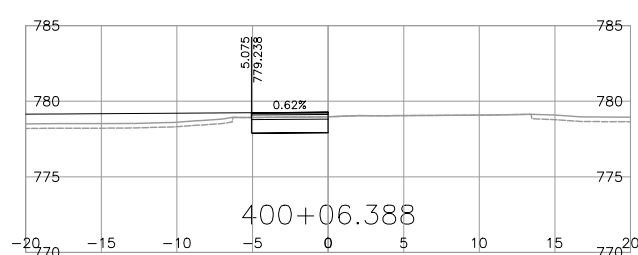
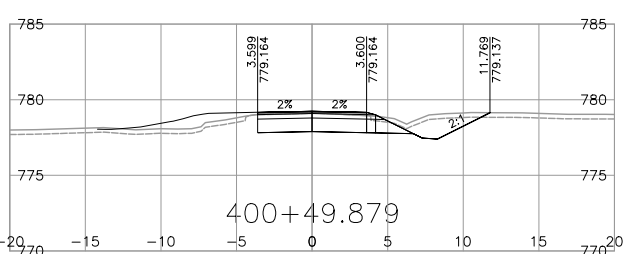
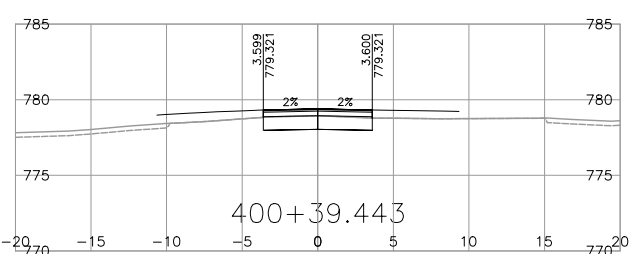
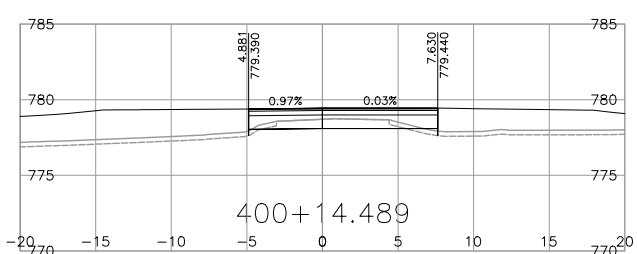
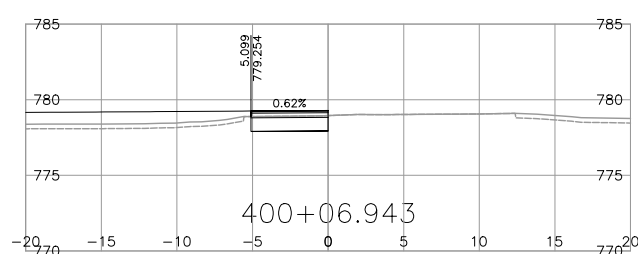
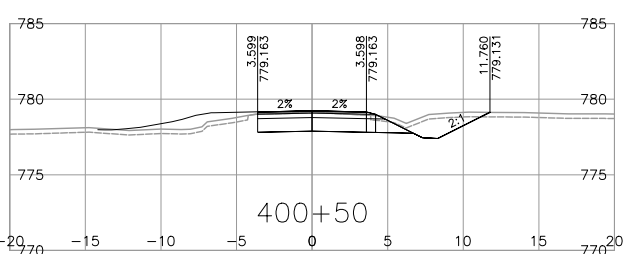
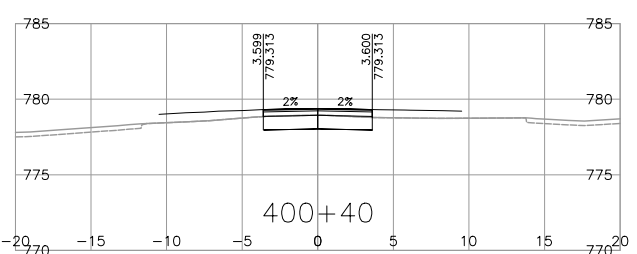
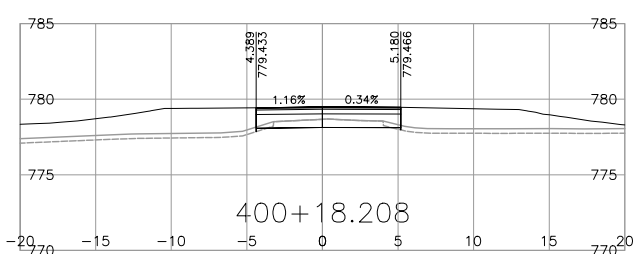
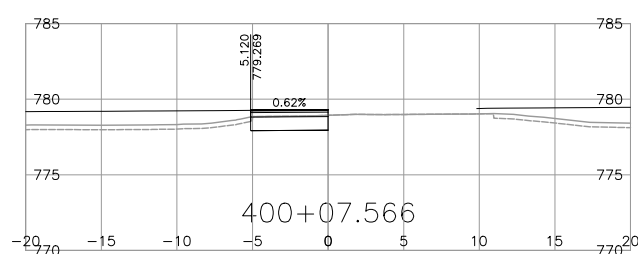
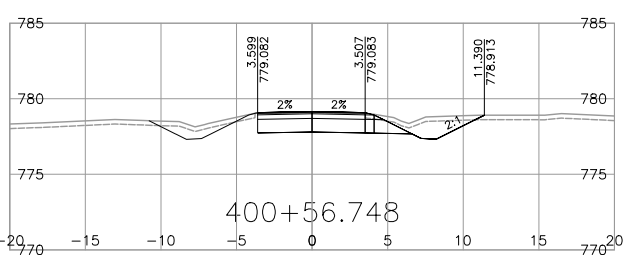
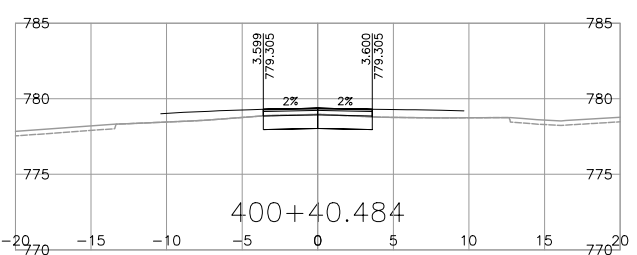
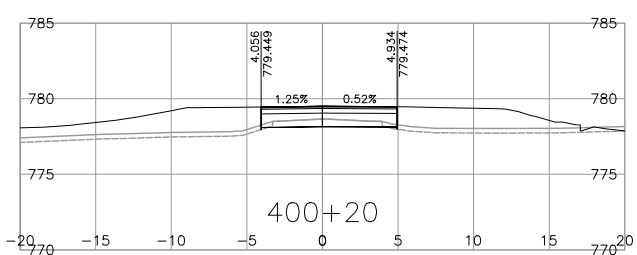
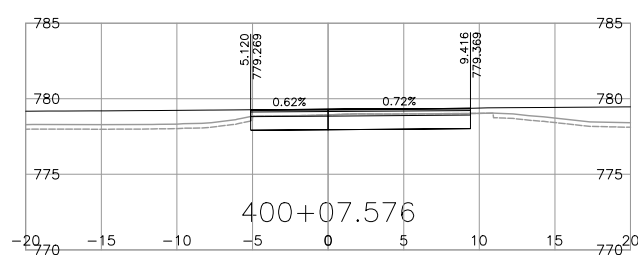
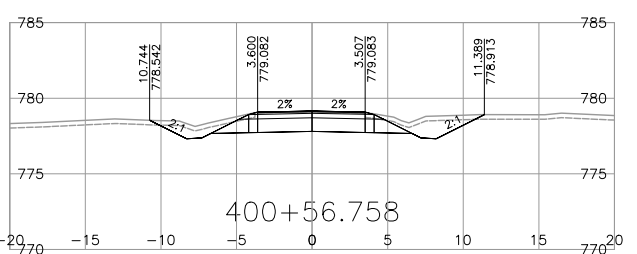
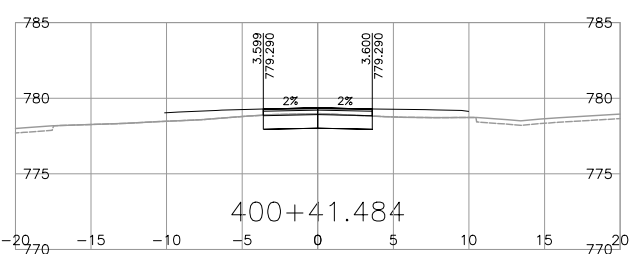
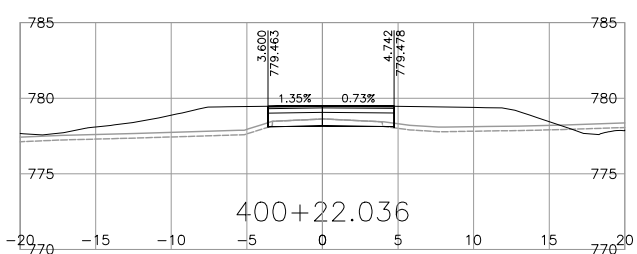
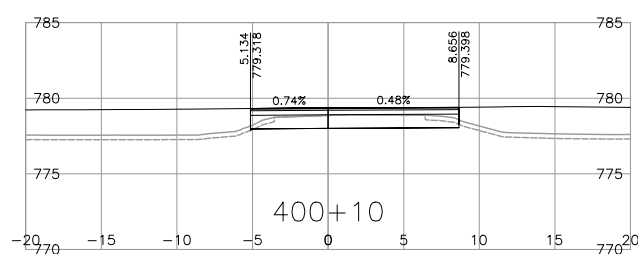

NOTE: STRIPPING REMOVAL APPLIES ONLY TO THE AREA BETWEEN SLOPE STAKE LINES (TOES & TOP OF CUT) OF PROPOSED ROADWAY TEMPLATE

FOR REFERENCE ONLY

DRAFT

FOR INFORMATION ONLY MARCH 03, 2023

BINNIE
The people behind your infrastructure.

R.F. BINNIE & ASSOCIATES LTD.
101 - 1577 7th Avenue,
Prince George, BC V2L 3P5
TEL 250 561 7274
BINNIE.com

BRITISH COLUMBIA

MINISTRY OF TRANSPORTATION AND INFRASTRUCTURE
NORTHERN REGION
HIGHWAY ENGINEERING AND GEOMATICS

CAD FILENAME: 21-0125-1000XS-1400AZ.DWG
DATE: 2023-03-01
FILE NUMBER: 21-0125-00

L400-LINE CROSS SECTIONS
HIGHWAY 16
GUEST ROAD AND SHALLOW BAY ROAD INTERSECTIONS

REV	DATE	REVISIONS	SIGNATURE

R. Mankowske
ENGINEER OF RECORD
DATE 20230303

DESIGNED	_____	R.M.	DATE	MAR_2023
QUALITY CONTROL	_____	K.T.	DATE	MAR_2023
QUALITY ASSURANCE	_____	R.M.	DATE	MAR_2023
DRAWN	_____	J.D.	DATE	MAR_2023

PROJECT NUMBER	38199-0000
REG	3

DRAWING NUMBER	L400-1XS
REV	

Mar. 1, 2023 - 11:11 AM P:\2021\21-0125-00 - CAD Files\CAD-Files\GuestRd\DrawingProduction\000_Design\Sections\0125-1000XS-L400Z

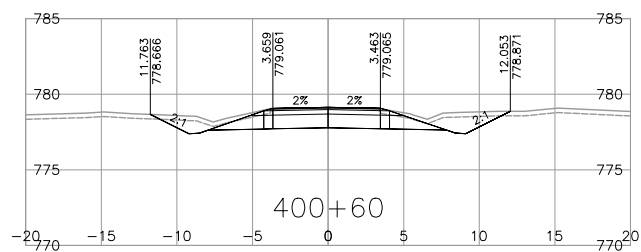
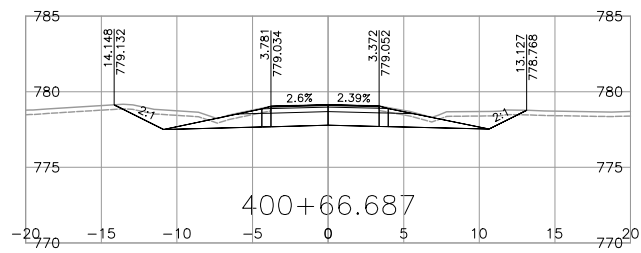



NOTE: STRIPPING REMOVAL APPLIES ONLY TO THE AREA BETWEEN SLOPE STAKE LINES (TOES & TOP OF CUT) OF PROPOSED ROADWAY TEMPLATE

FOR REFERENCE ONLY

DRAFT

FOR INFORMATION ONLY MARCH 03, 2023

 The people behind your infrastructure.	R.F. BINNIE & ASSOCIATES LTD. 101 - 1577 7th Avenue, Prince George, BC V2L 3P5 TEL 250 561 7274 BINNIE.com	 BRITISH COLUMBIA	MINISTRY OF TRANSPORTATION AND INFRASTRUCTURE NORTHERN REGION HIGHWAY ENGINEERING AND GEOMATICS																																
SCALE $\frac{0 \quad 2 \quad 1:250 \quad 12m}{\rule{1.5cm}{0.4pt}}$		L400-LINE CROSS SECTIONS HIGHWAY 16 GUEST ROAD AND SHALLOW BAY ROAD INTERSECTIONS																																	
CAD FILENAME: 21-0125-1000XS-L400AZ.DWG DATE: 2023-03-01 FILE NUMBER: 21-0125-00		DESIGNED: _____ R.M. DATE: MAR_2023 QUALITY CONTROL: _____ K.T. DATE: MAR_2023 QUALITY ASSURANCE: _____ R.M. DATE: MAR_2023 DRAWN: _____ J.D. DATE: MAR_2023																																	
<table border="1" style="width: 100%; border-collapse: collapse;"> <thead> <tr> <th>REV</th> <th>DATE</th> <th>REVISIONS</th> <th>SIGNATURE</th> </tr> </thead> <tbody> <tr><td> </td><td> </td><td> </td><td> </td></tr> <tr><td> </td><td> </td><td> </td><td> </td></tr> <tr><td> </td><td> </td><td> </td><td> </td></tr> <tr><td> </td><td> </td><td> </td><td> </td></tr> <tr><td> </td><td> </td><td> </td><td> </td></tr> <tr><td> </td><td> </td><td> </td><td> </td></tr> <tr><td> </td><td> </td><td> </td><td> </td></tr> </tbody> </table>		REV	DATE	REVISIONS	SIGNATURE																													R. Mankowske ENGINEER OF RECORD DATE: 20230303	
REV	DATE	REVISIONS	SIGNATURE																																
PROJECT NUMBER: 38199-0000		REG: 3 DRAWING NUMBER: L400-2XS																																	

Mar. 1, 2023 - 11:18 AM P:\2021\21-0125-00 - CAD Files\CAD\H1\Cross\H1\Drawing\Production\000_Design\Sections\0125-1000XS-L500A1

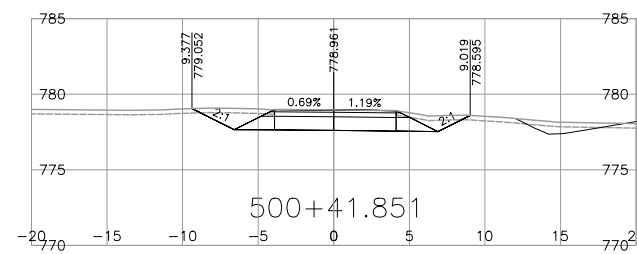
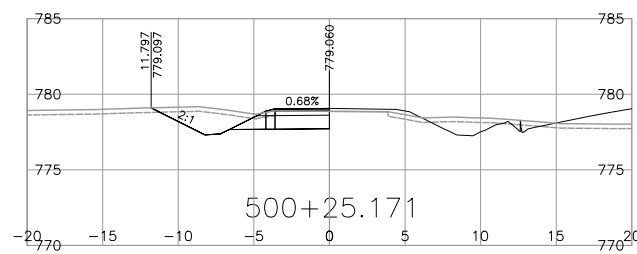
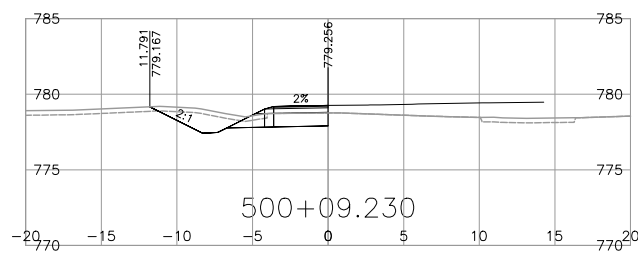
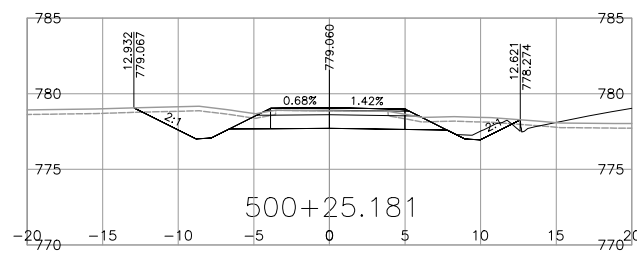
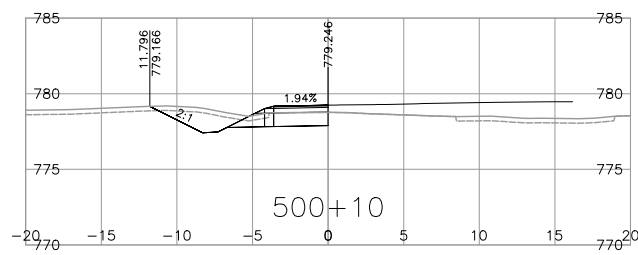
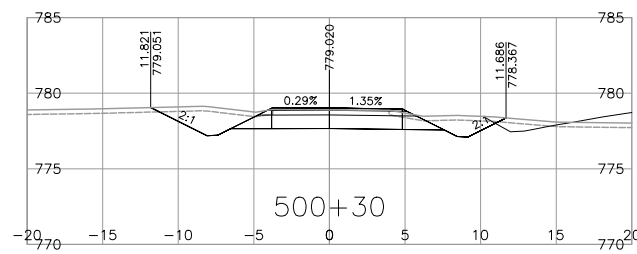
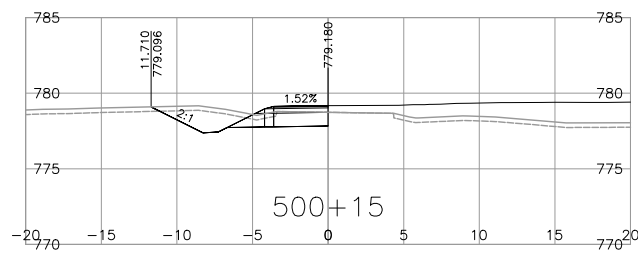
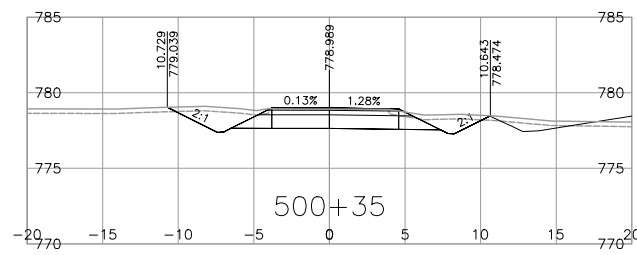
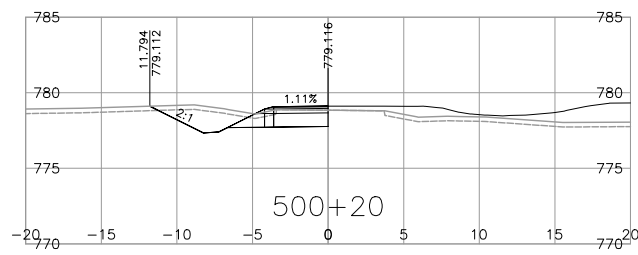
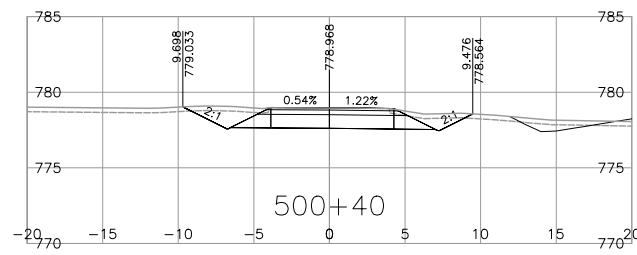
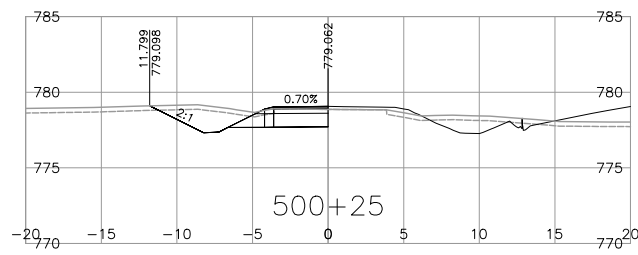

NOTE: STRIPPING REMOVAL APPLIES ONLY TO THE AREA BETWEEN SLOPE STAKE LINES (TOES & TOP OF CUT) OF PROPOSED ROADWAY TEMPLATE

FOR REFERENCE ONLY

DRAFT

FOR INFORMATION ONLY MARCH 03, 2023

BINNIE
The people behind your infrastructure.

R.F. BINNIE & ASSOCIATES LTD.
101 - 1577 7th Avenue,
Prince George, BC V2L 3P5
TEL 250 561 7274
BINNIE.com

BRITISH COLUMBIA

MINISTRY OF TRANSPORTATION AND INFRASTRUCTURE
NORTHERN REGION
HIGHWAY ENGINEERING AND GEOMATICS

SCALE 0 2 1:250 12m

CAD FILENAME 21-0125-1000XS-L500A1.DWG
DATE 2023-03-01
FILE NUMBER 21-0125-00

REV	DATE	REVISIONS	SIGNATURE

L500-LINE CROSS SECTIONS
HIGHWAY 16
GUEST ROAD AND SHALLOW BAY ROAD INTERSECTIONS

DESIGNED	_____	R.M.	DATE	MAR. 2023
QUALITY CONTROL	_____	K.T.	DATE	MAR. 2023
QUALITY ASSURANCE	_____	R.M.	DATE	MAR. 2023
DRAWN	_____	J.D.	DATE	MAR. 2023

R. Mankowske
ENGINEER OF RECORD
DATE 20230303

PROJECT NUMBER	38199-0000	REG	3	DRAWING NUMBER	L500-1XS	REV	
----------------	------------	-----	---	----------------	----------	-----	--

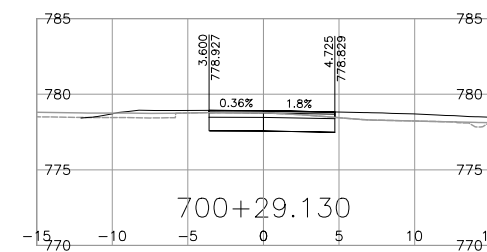
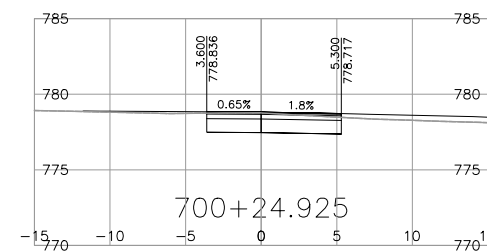
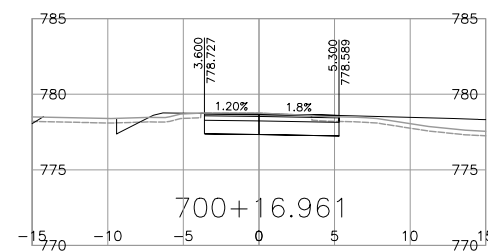
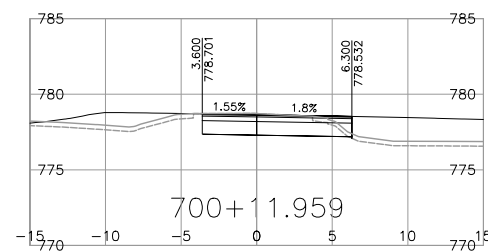
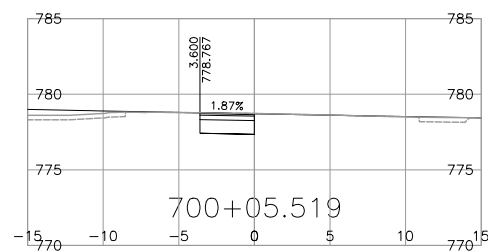
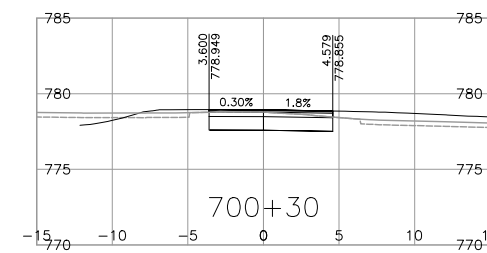
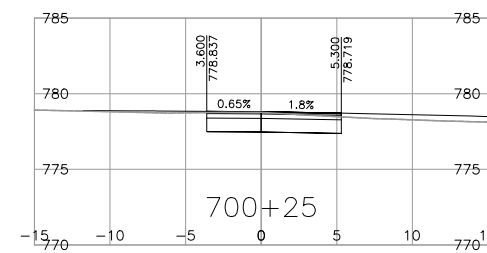
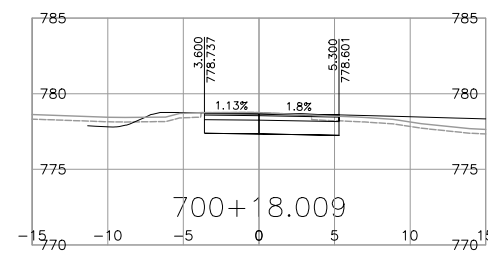
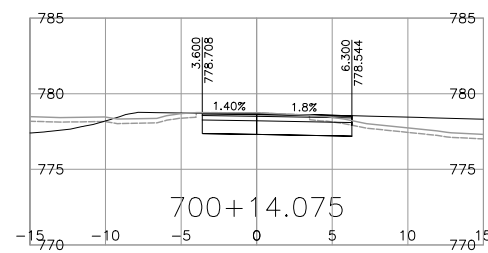
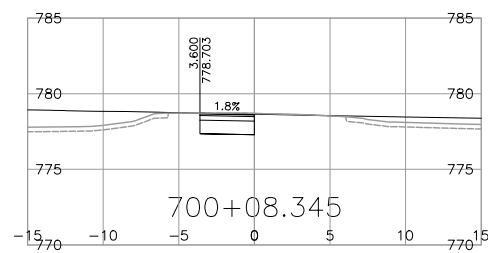
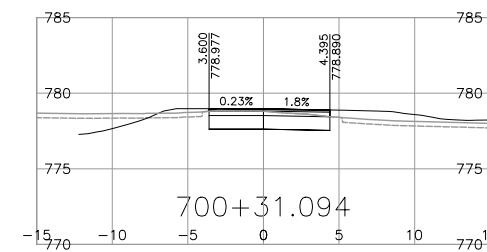
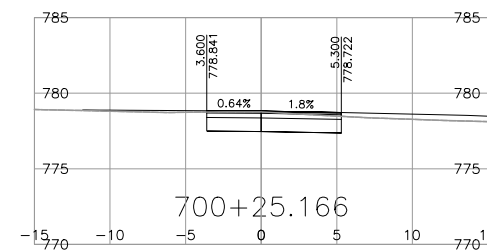
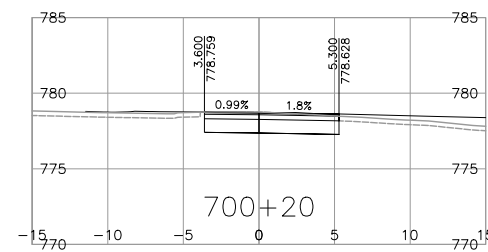
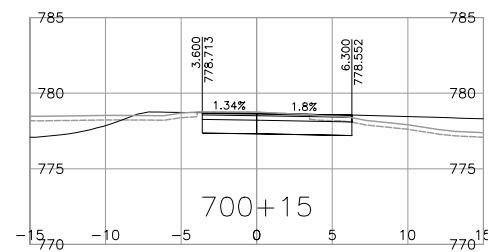
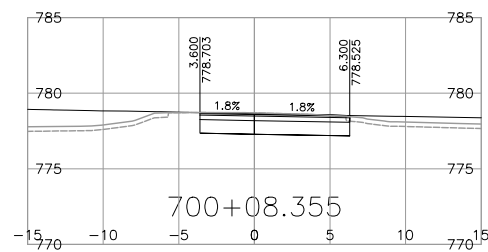
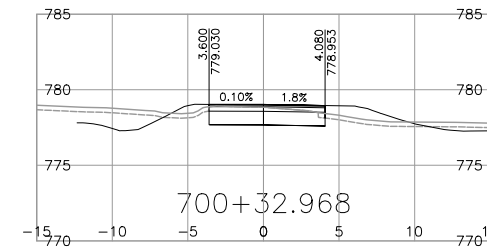
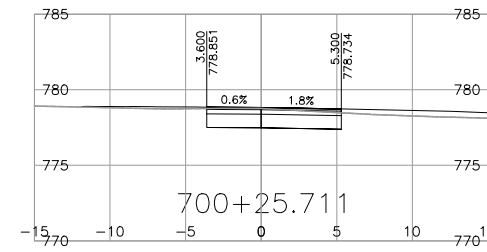
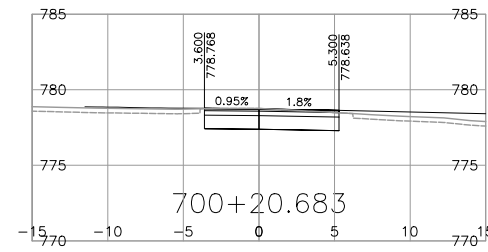
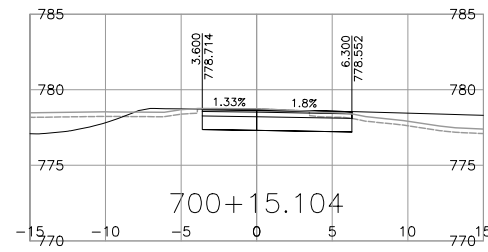
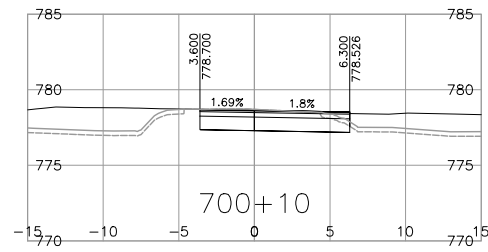
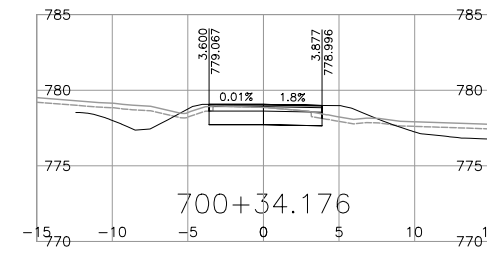
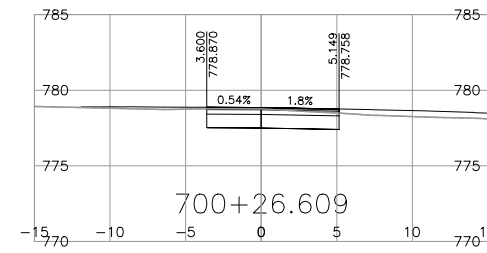
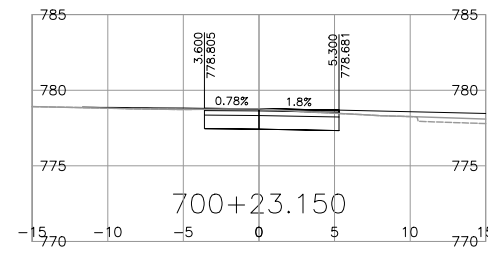
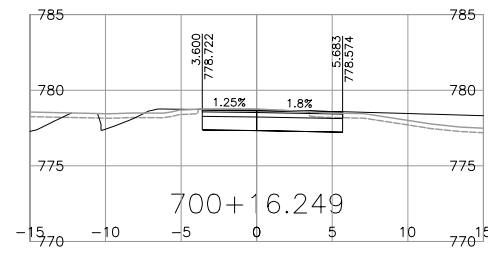
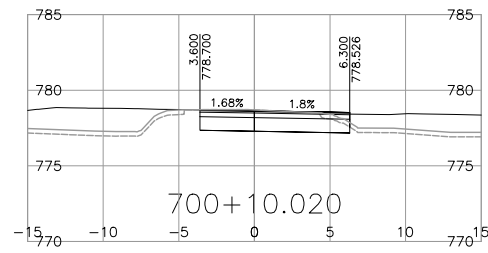

NOTE: STRIPPING REMOVAL APPLIES ONLY TO THE AREA BETWEEN SLOPE STAKE LINES (TOES & TOP OF CUT) OF PROPOSED ROADWAY TEMPLATE

FOR REFERENCE ONLY

DRAFT

FOR INFORMATION ONLY MARCH 03, 2023

BINNIE
The people behind your infrastructure.

R.F. BINNIE & ASSOCIATES LTD.
101 - 1577 7th Avenue,
Prince George, BC V2L 3P5
TEL 250 561 7274
BINNIE.com

BRITISH COLUMBIA

MINISTRY OF TRANSPORTATION AND INFRASTRUCTURE
NORTHERN REGION
HIGHWAY ENGINEERING AND GEOMATICS

SCALE 0 2 1:250 12m CAD FILENAME 21-0125-1000XS-L700A1.DWG DATE 2023-03-01 FILE NUMBER 21-0125-00

REV	DATE	REVISIONS	SIGNATURE

L700-LINE CROSS SECTIONS
HIGHWAY 16
GUEST ROAD AND SHALLOW BAY ROAD INTERSECTIONS

R. Mankowske
ENGINEER OF RECORD
DATE 20230303

DESIGNED	_____	R.M.	DATE	MAR. 2023
QUALITY CONTROL	_____	K.T.	DATE	MAR. 2023
QUALITY ASSURANCE	_____	R.M.	DATE	MAR. 2023
DRAWN	_____	J.D.	DATE	MAR. 2023
PROJECT NUMBER	38199-0000	REG	3	DRAWING NUMBER
				L700-1XS

Mar. 1, 2023 - 11:24 AM P:\2021\21-0125-00 - CAD Files\CAD-Files\H1-Drawing\Production\000_Design\Sections\0125-1000XS-L700A1

Mar. 1, 2023 - 11:24 AM P:\2021\21-0125-00 - CAD Files\CAD-HR\Cross-RI\DrawingProduction\000_Design\Sections\0125-1000XS-L700A1

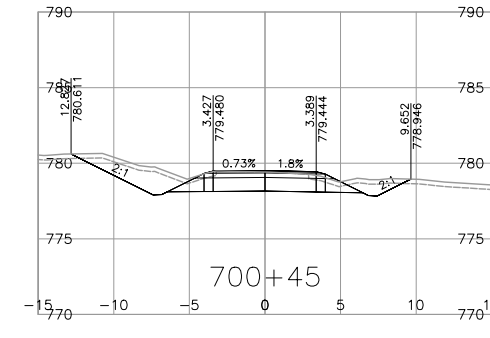
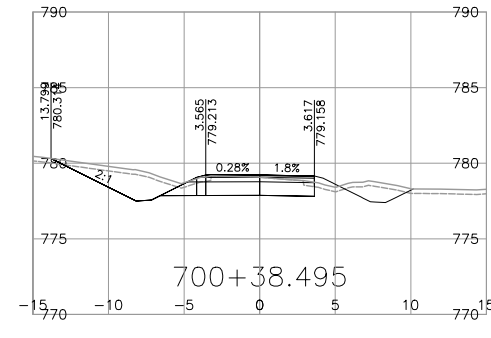
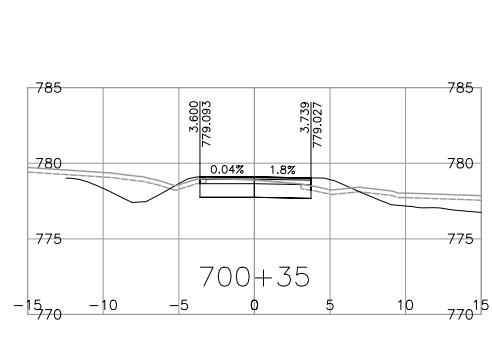
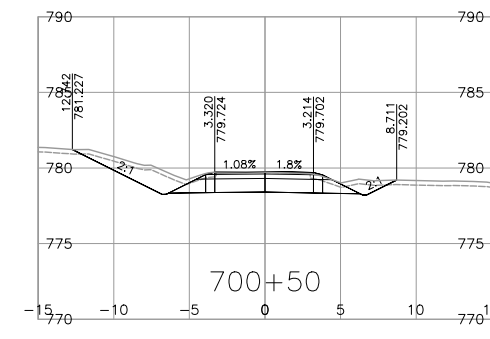
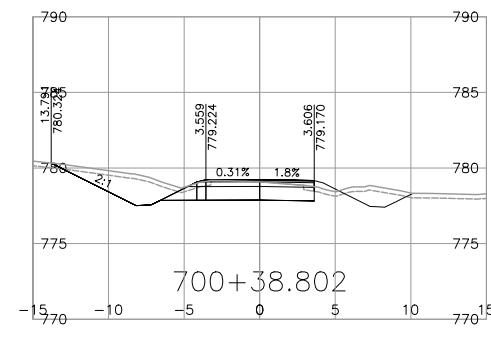
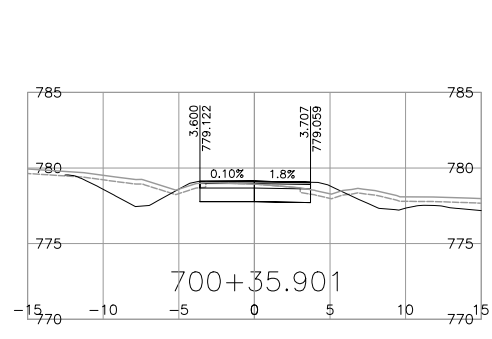
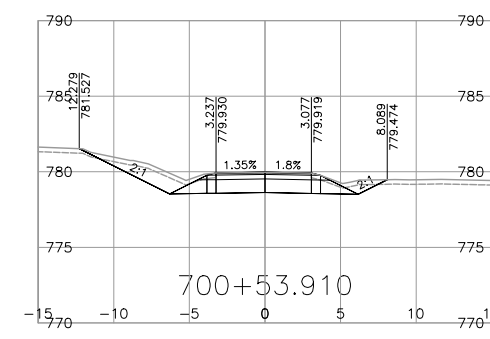
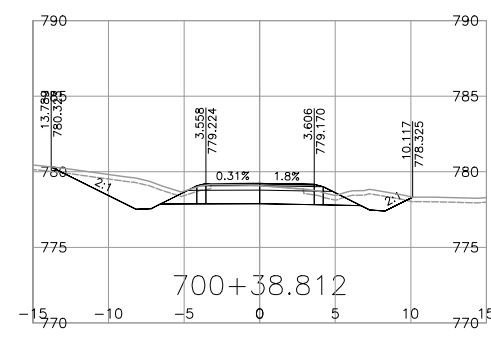
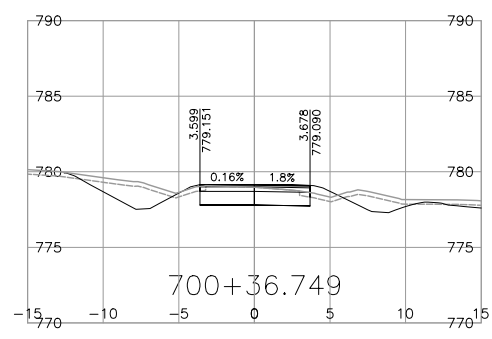
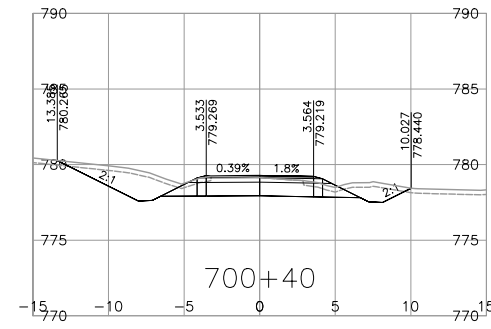
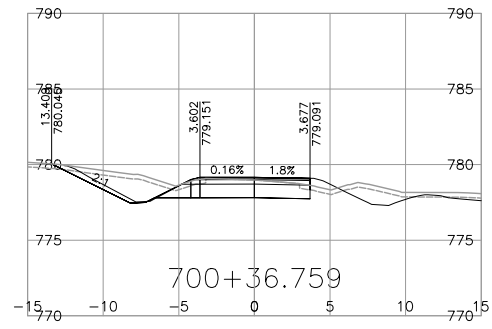



NOTE: STRIPPING REMOVAL APPLIES ONLY TO THE AREA BETWEEN SLOPE STAKE LINES (TOES & TOP OF CUT) OF PROPOSED ROADWAY TEMPLATE

FOR REFERENCE ONLY

DRAFT

FOR INFORMATION ONLY MARCH 03, 2023

 The people behind your infrastructure.	R.F. BINNIE & ASSOCIATES LTD. 101 - 1577 7th Avenue, Prince George, BC V2L 3P5 TEL 250 561 7274 BINNIE.COM	 BRITISH COLUMBIA	MINISTRY OF TRANSPORTATION AND INFRASTRUCTURE NORTHERN REGION HIGHWAY ENGINEERING AND GEOMATICS
SCALE $\frac{0 \quad 2 \quad 1:250 \quad 12m}{\rule{1.5cm}{0.4pt}}$		CAD FILENAME <u>21-0125-1000XS-L700A1.DWG</u> DATE <u>2023-03-01</u> FILE NUMBER <u>21-0125-00</u>	
L700-LINE CROSS SECTIONS HIGHWAY 16 GUEST ROAD AND SHALLOW BAY ROAD INTERSECTIONS			
REV DATE REVISIONS SIGNATURE	DESIGNED _____ R.M. DATE <u>MAR 2023</u> QUALITY CONTROL _____ K.T. DATE <u>MAR 2023</u> QUALITY ASSURANCE _____ R.M. DATE <u>MAR 2023</u> DRAWN _____ J.D. DATE <u>MAR 2023</u>		
PROJECT NUMBER 38199-0000 REG 3		DRAWING NUMBER L700-2XS REV _____	
R. Mankowske ENGINEER OF RECORD DATE 20230303			

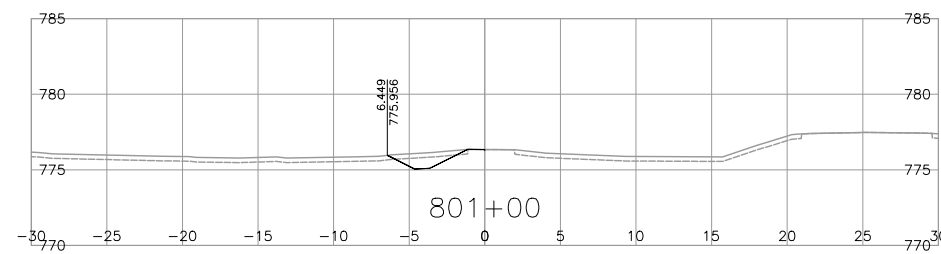
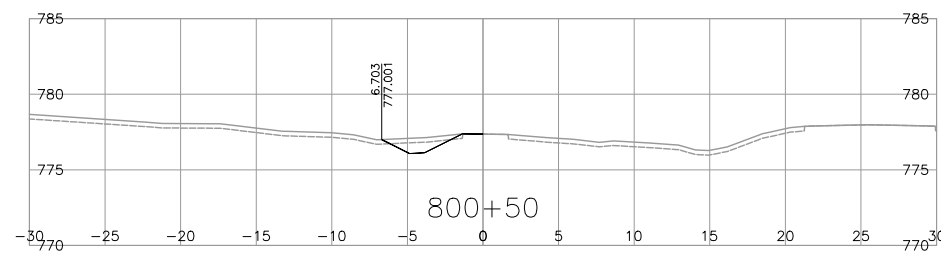
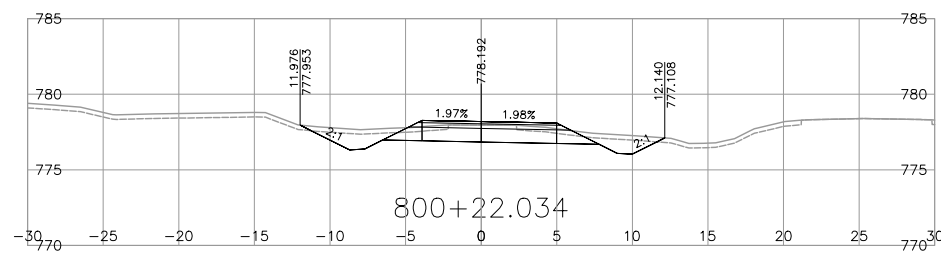
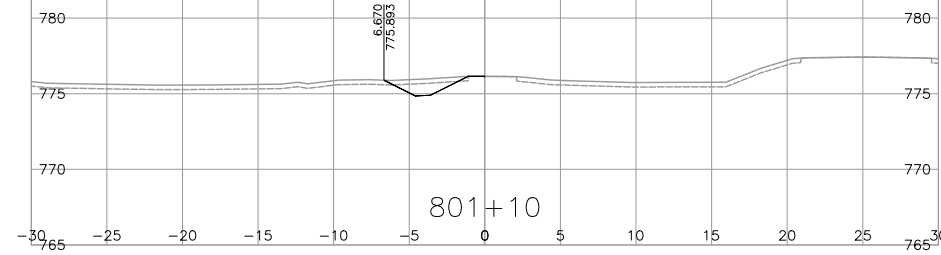
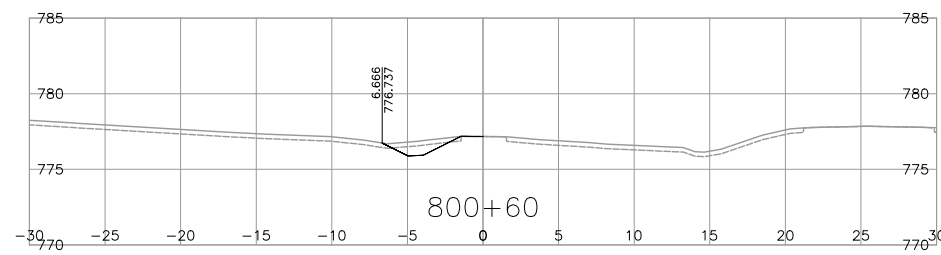
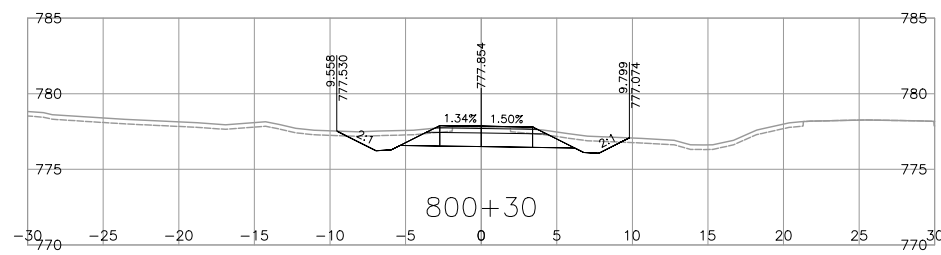
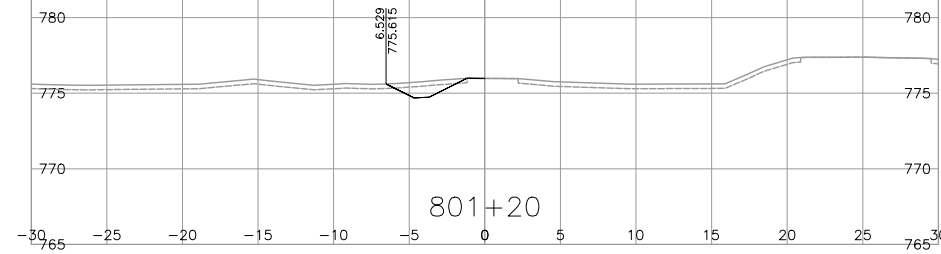
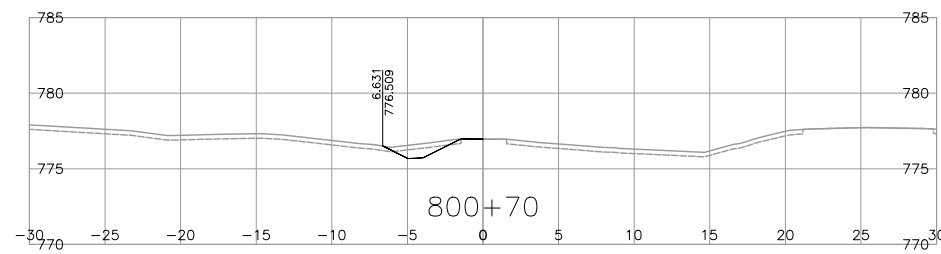
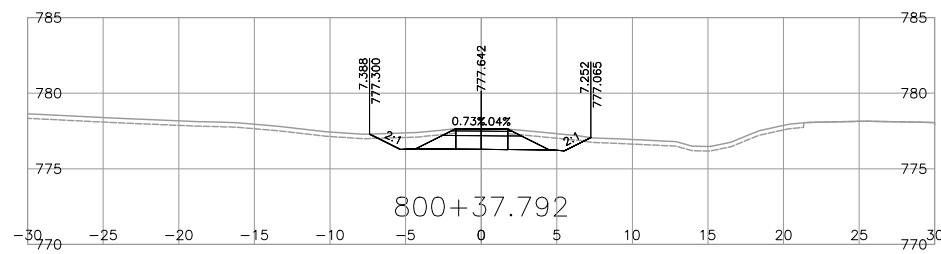
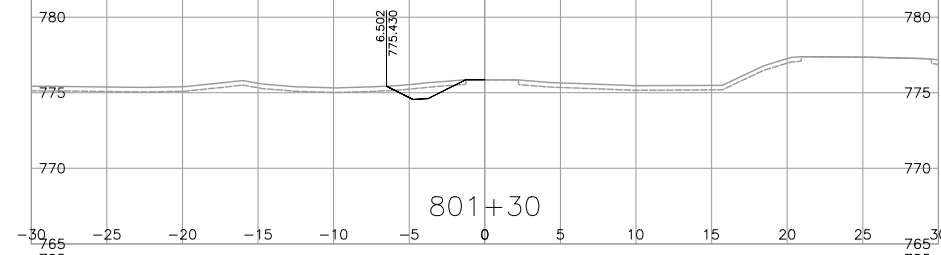
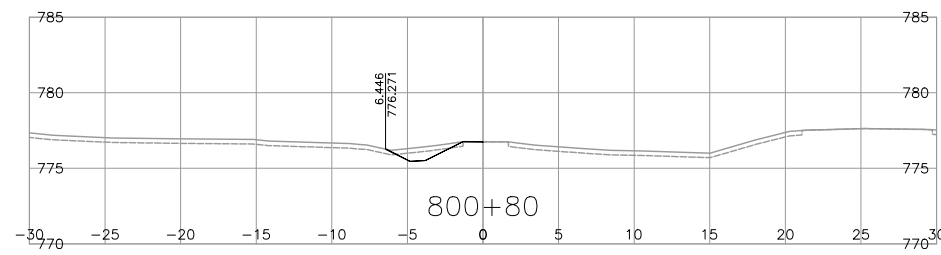
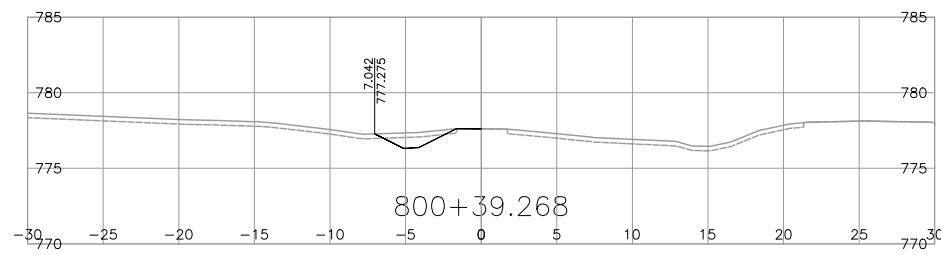
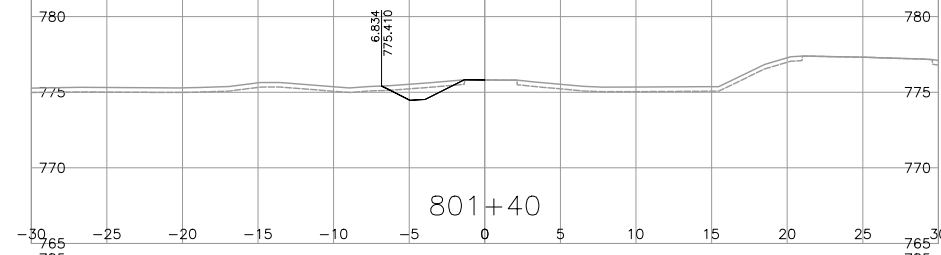
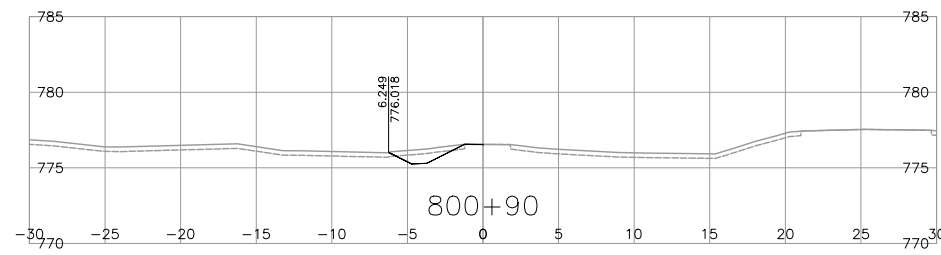
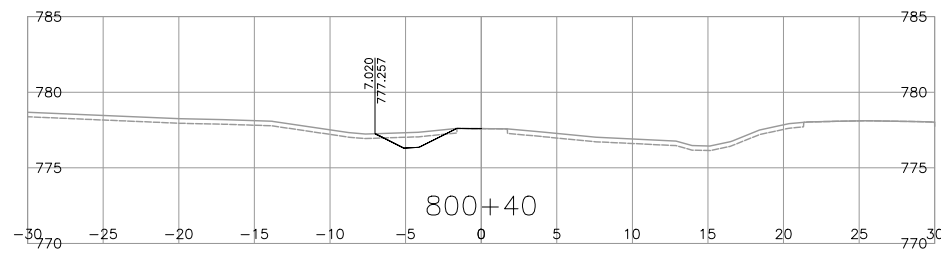

NOTE: STRIPPING REMOVAL APPLIES ONLY TO THE AREA BETWEEN SLOPE STAKE LINES (TOES & TOP OF CUT) OF PROPOSED ROADWAY TEMPLATE

FOR REFERENCE ONLY

DRAFT

FOR INFORMATION ONLY MARCH 03, 2023

R.F. BINNIE & ASSOCIATES LTD.
101 - 1577 7th Avenue,
Prince George, BC V2L 3P5
TEL 250 561 7274
BINNIE.com

MINISTRY OF TRANSPORTATION
AND INFRASTRUCTURE
NORTHERN REGION
HIGHWAY ENGINEERING AND GEOMATICS

L800-LINE CROSS SECTIONS
HIGHWAY 16
GUEST ROAD AND SHALLOW BAY ROAD INTERSECTIONS

SCALE	0 2 1:250 12m	CAD FILENAME	21-0125-1000XS-L800A1.DWG
REV	DATE	REVISIONS	SIGNATURE

R. Mankowske
ENGINEER OF RECORD
DATE 20230303

DESIGNED _____ R.M. DATE MAR 2023
QUALITY CONTROL _____ K.T. DATE MAR 2023
QUALITY ASSURANCE _____ R.M. DATE MAR 2023
DRAWN _____ J.D. DATE MAR 2023

PROJECT NUMBER 38199-0000 REG 3 DRAWING NUMBER L800-1XS

Mar 1, 2023 - 11:25 AM P:\2021\21-0125-00 - CAD Files\CAD-Highway\Production\000_Design\Sections\0125-1000XS-L800A1

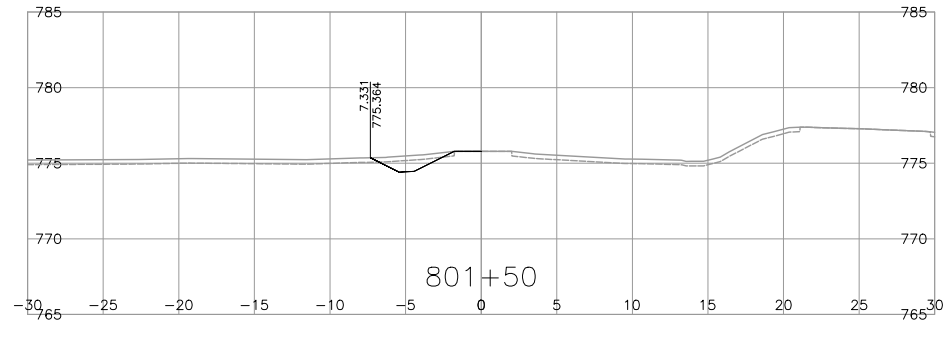
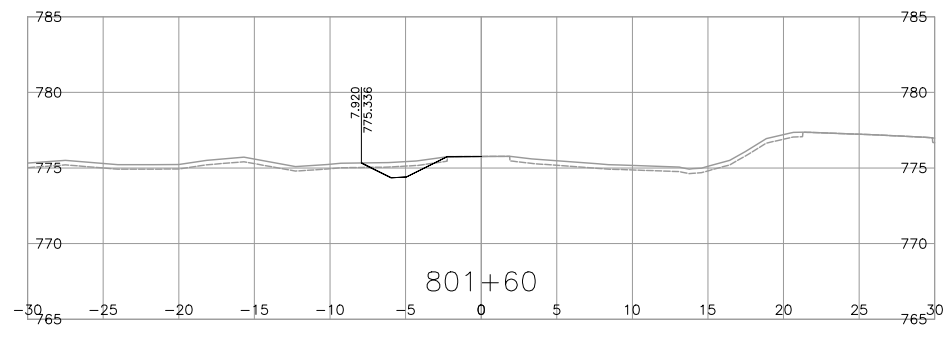
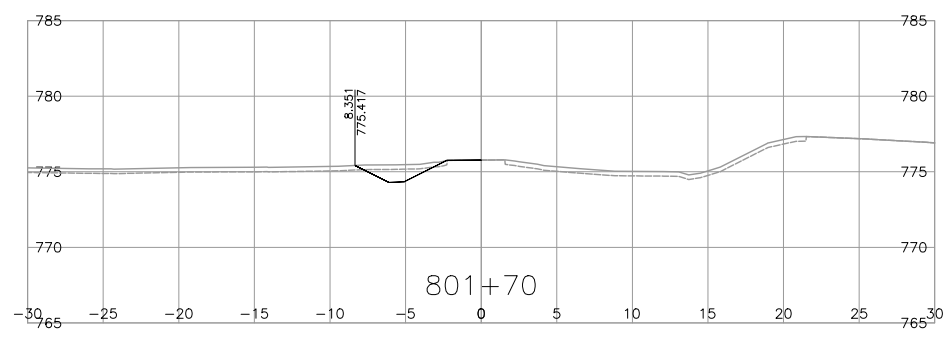
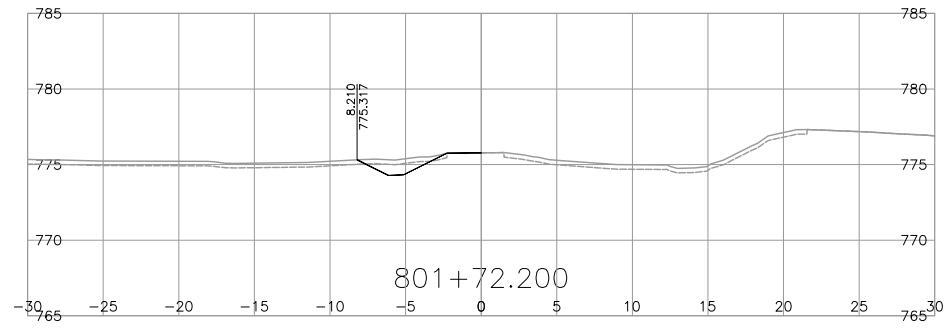

NOTE: STRIPPING REMOVAL APPLIES ONLY TO THE AREA BETWEEN SLOPE STAKE LINES (TOES & TOP OF CUT) OF PROPOSED ROADWAY TEMPLATE

FOR REFERENCE ONLY

DRAFT

FOR INFORMATION ONLY MARCH 03, 2023

Mar. 1, 2023 - 11:25 AM P:\2021\21-0125-00 - CAD Files\CAD-Highway\H1\DrawingProduction\000_Design\Sections\H1-0125-1000XS-L800A1

		R.F. BINNIE & ASSOCIATES LTD. 101 - 1577 7th Avenue, Prince George, BC V2L 3P5 TEL 250 561 7274 BINNIE.com				MINISTRY OF TRANSPORTATION AND INFRASTRUCTURE NORTHERN REGION HIGHWAY ENGINEERING AND GEOMATICS	
SCALE		CAD FILENAME <u>21-0125-1000XS-L800A1.DWG</u> DATE <u>2023-03-01</u> FILE NUMBER <u>21-0125-00</u>		L800-LINE CROSS SECTIONS HIGHWAY 16 GUEST ROAD AND SHALLOW BAY ROAD INTERSECTIONS			
REV	DATE	REVISIONS	SIGNATURE	DESIGNED _____ R.M. DATE <u>MAR 2023</u> QUALITY CONTROL _____ K.T. DATE <u>MAR 2023</u> QUALITY ASSURANCE _____ R.M. DATE <u>MAR 2023</u> DRAWN _____ J.D. DATE <u>MAR 2023</u>			
			R. Mankowske ENGINEER OF RECORD DATE 20230303		PROJECT NUMBER <u>38199-0000</u> REG <u>3</u> DRAWING NUMBER <u>L800-2XS</u> REV _____		

Mar. 1, 2023 - 11:28 AM P:\2021\21-0125-00 - CAD Files\CAD-Files\H1\DrawingProduction\000_Design\Sections\1-0125-1000XS-L900A1

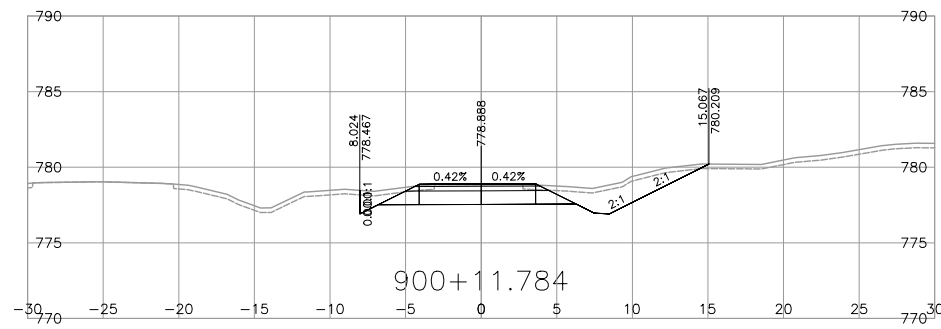
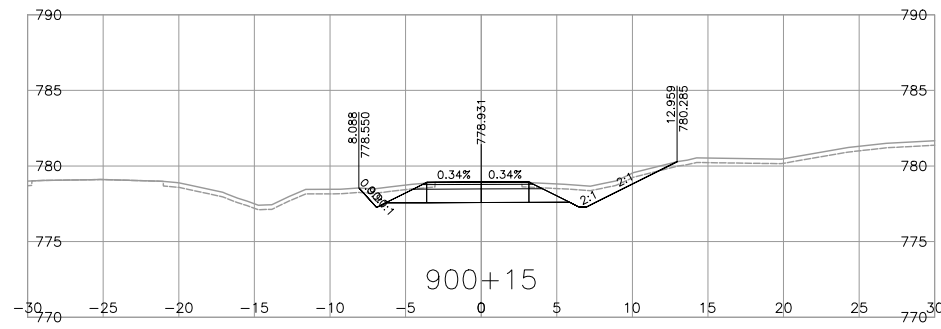
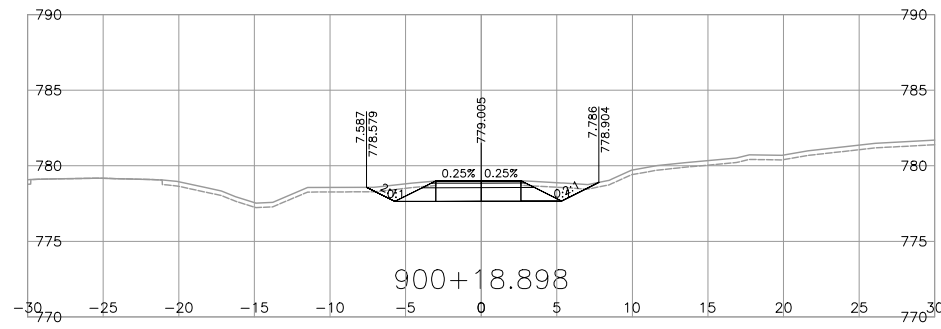



NOTE: STRIPPING REMOVAL APPLIES ONLY TO THE AREA BETWEEN SLOPE STAKE LINES (TOES & TOP OF CUT) OF PROPOSED ROADWAY TEMPLATE

FOR REFERENCE ONLY

DRAFT

FOR INFORMATION ONLY MARCH 03, 2023

 The people behind your infrastructure.	R.F. BINNIE & ASSOCIATES LTD. 101 - 1577 7th Avenue, Prince George, BC V2L 3P5 TEL 250 561 7274 BINNIE.com	 BRITISH COLUMBIA	MINISTRY OF TRANSPORTATION AND INFRASTRUCTURE NORTHERN REGION HIGHWAY ENGINEERING AND GEOMATICS																																				
SCALE  CAD FILENAME <u>21-0125-1000XS-L900A1.DWG</u> DATE <u>2023-03-01</u> FILE NUMBER <u>21-0125-00</u>		L900-LINE CROSS SECTIONS HIGHWAY 16 GUEST ROAD AND SHALLOW BAY ROAD INTERSECTIONS																																					
<table border="1" style="width: 100%; border-collapse: collapse;"> <thead> <tr> <th>REV</th> <th>DATE</th> <th>REVISIONS</th> <th>SIGNATURE</th> </tr> </thead> <tbody> <tr><td> </td><td> </td><td> </td><td> </td></tr> <tr><td> </td><td> </td><td> </td><td> </td></tr> <tr><td> </td><td> </td><td> </td><td> </td></tr> <tr><td> </td><td> </td><td> </td><td> </td></tr> <tr><td> </td><td> </td><td> </td><td> </td></tr> </tbody> </table>	REV	DATE	REVISIONS	SIGNATURE																							<table border="1" style="width: 100%; border-collapse: collapse;"> <tr> <td>DESIGNED _____</td> <td>R.M.</td> <td>DATE <u>MAR_2023</u></td> </tr> <tr> <td>QUALITY CONTROL _____</td> <td>K.T.</td> <td>DATE <u>MAR_2023</u></td> </tr> <tr> <td>QUALITY ASSURANCE _____</td> <td>R.M.</td> <td>DATE <u>MAR_2023</u></td> </tr> <tr> <td>DRAWN _____</td> <td>J.D.</td> <td>DATE <u>MAR_2023</u></td> </tr> </table>	DESIGNED _____	R.M.	DATE <u>MAR_2023</u>	QUALITY CONTROL _____	K.T.	DATE <u>MAR_2023</u>	QUALITY ASSURANCE _____	R.M.	DATE <u>MAR_2023</u>	DRAWN _____	J.D.	DATE <u>MAR_2023</u>
REV	DATE	REVISIONS	SIGNATURE																																				
DESIGNED _____	R.M.	DATE <u>MAR_2023</u>																																					
QUALITY CONTROL _____	K.T.	DATE <u>MAR_2023</u>																																					
QUALITY ASSURANCE _____	R.M.	DATE <u>MAR_2023</u>																																					
DRAWN _____	J.D.	DATE <u>MAR_2023</u>																																					
		R. Mankowske ENGINEER OF RECORD DATE 20230303	<table border="1" style="width: 100%; border-collapse: collapse;"> <tr> <td>PROJECT NUMBER</td> <td>REG</td> <td>DRAWING NUMBER</td> <td>REV</td> </tr> <tr> <td>38199-0000</td> <td>3</td> <td>L900-1XS</td> <td> </td> </tr> </table>	PROJECT NUMBER	REG	DRAWING NUMBER	REV	38199-0000	3	L900-1XS																													
PROJECT NUMBER	REG	DRAWING NUMBER	REV																																				
38199-0000	3	L900-1XS																																					

Mar. 1, 2023 - 10:40 AM P:\2021\21-0125-00 - CAD Files\CAD-HR\Cross-Sections\Production\000_Design\Sections\0125-1000XS-C10A1

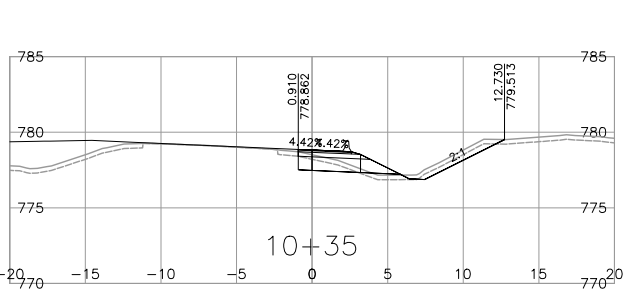
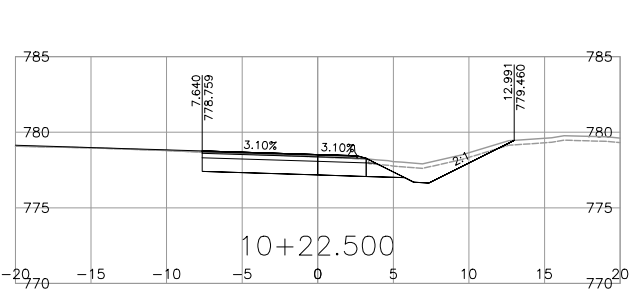
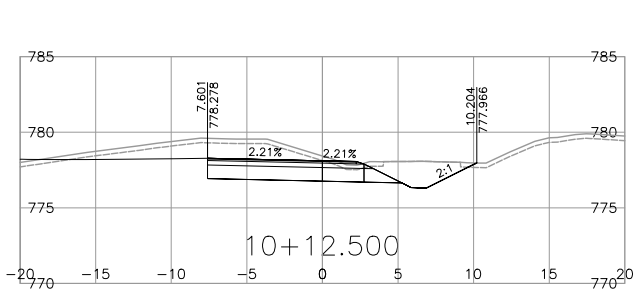
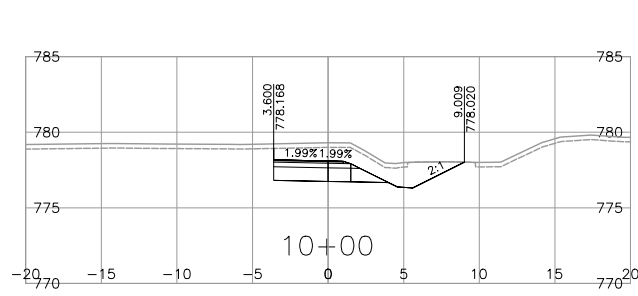
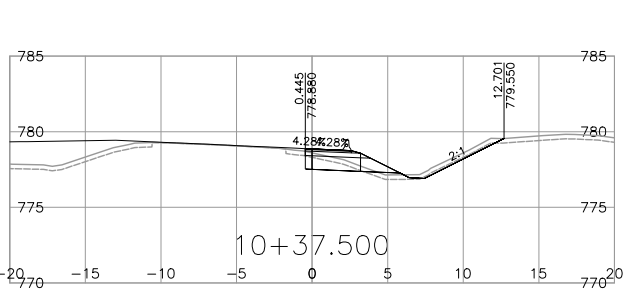
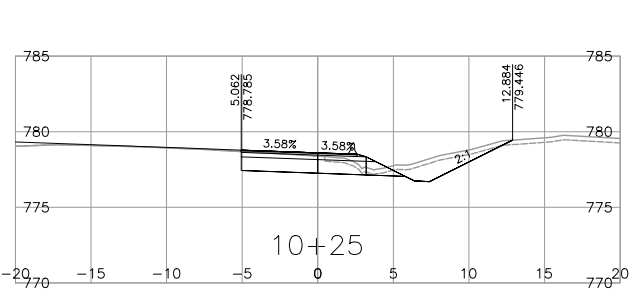
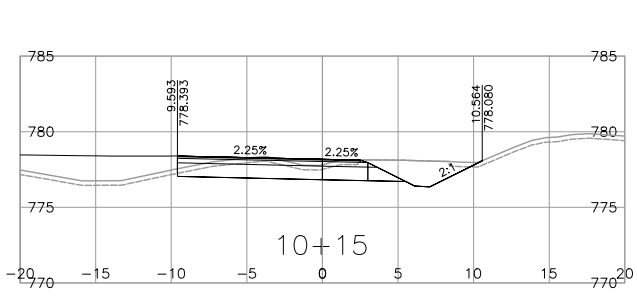
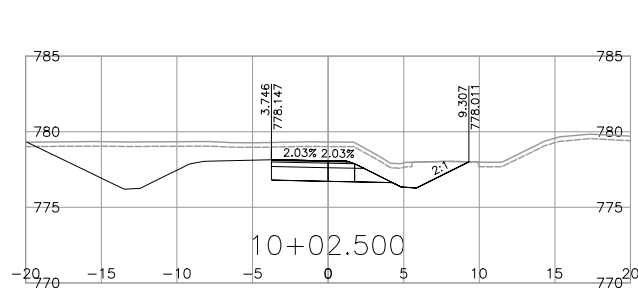
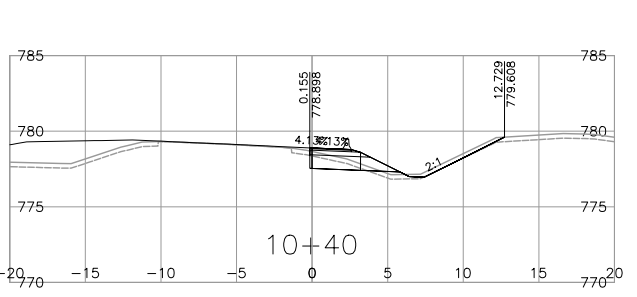
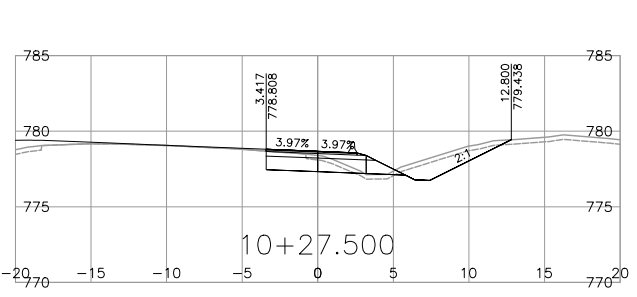
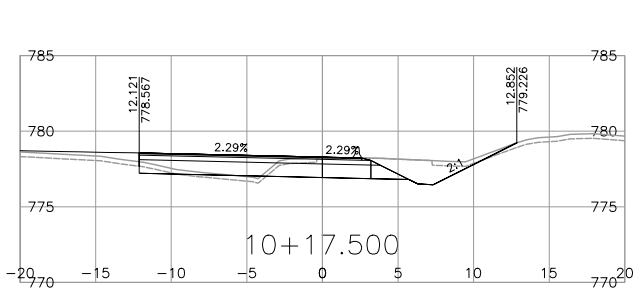
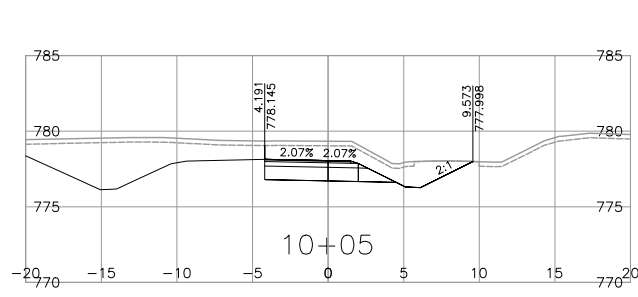
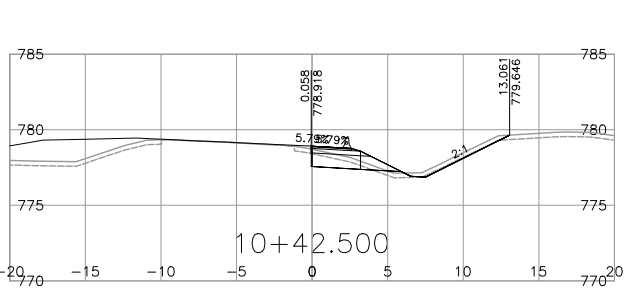
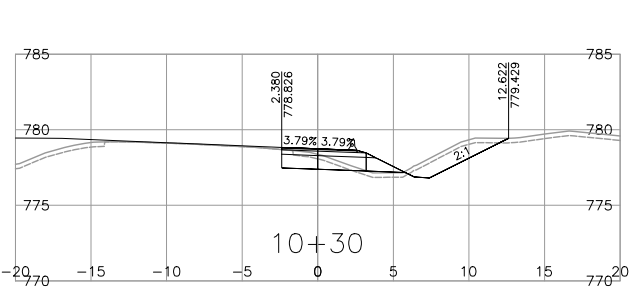
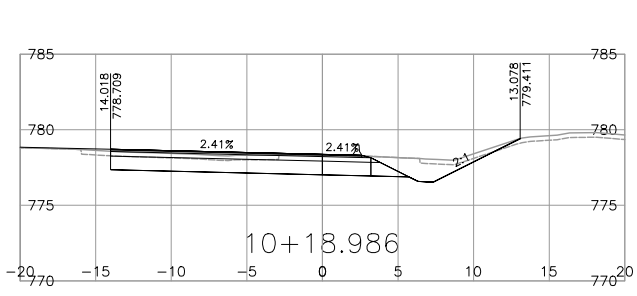
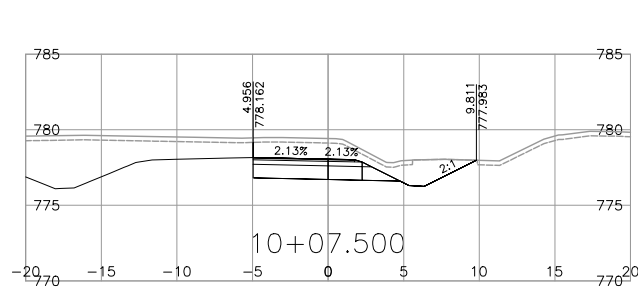
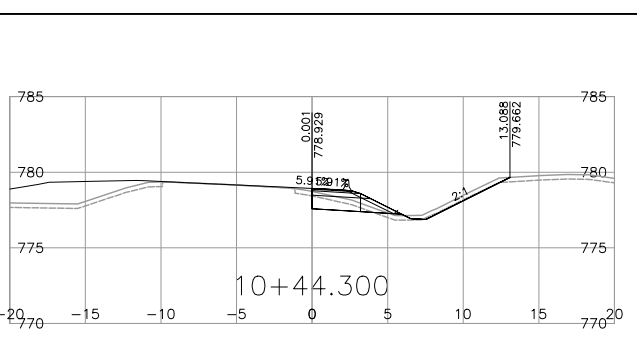
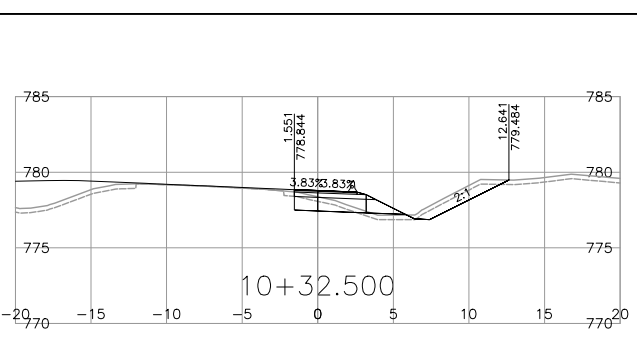
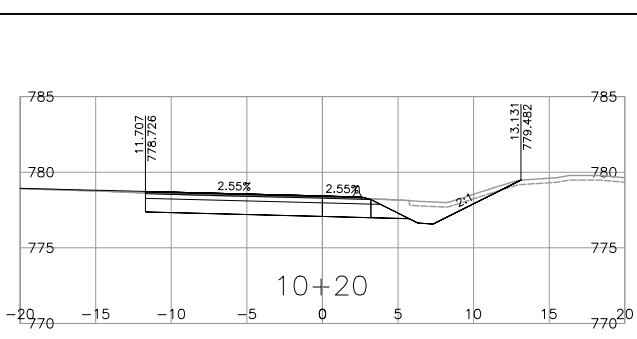
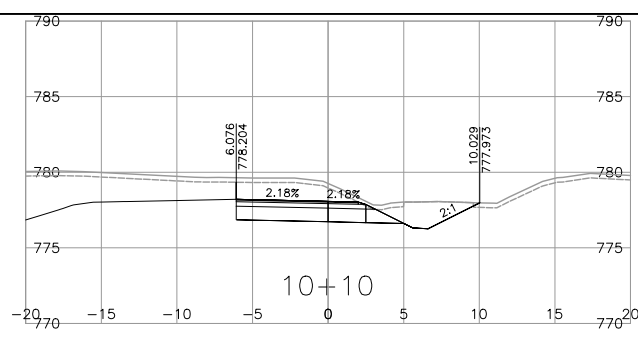

NOTE: STRIPPING REMOVAL APPLIES ONLY TO THE AREA BETWEEN SLOPE STAKE LINES (TOES & TOP OF CUT) OF PROPOSED ROADWAY TEMPLATE

FOR REFERENCE ONLY

DRAFT

FOR INFORMATION ONLY MARCH 03, 2023

R.F. BINNIE & ASSOCIATES LTD.
101 - 1577 7th Avenue,
Prince George, BC V2L 3P5
TEL 250 561 7274
BINNIE.com

BRITISH COLUMBIA

MINISTRY OF TRANSPORTATION AND INFRASTRUCTURE
NORTHERN REGION
HIGHWAY ENGINEERING AND GEOMATICS

C10-LINE CROSS SECTIONS
HIGHWAY 16
GUEST ROAD AND SHALLOW BAY ROAD INTERSECTIONS

SCALE 1:250

CAD FILENAME: 21-0125-1000XS-C10A1.DWG
DATE: 2023-03-01
FILE NUMBER: 21-0125-00

REV	DATE	REVISIONS	SIGNATURE

DESIGNED	_____	R.M.	DATE	MAR_2023
QUALITY CONTROL	_____	K.T.	DATE	MAR_2023
QUALITY ASSURANCE	_____	R.M.	DATE	MAR_2023
DRAWN	_____	J.D.	DATE	MAR_2023

R. Mankowske
ENGINEER OF RECORD
DATE 20230303

PROJECT NUMBER	38199-0000	REG	3	DRAWING NUMBER	R3-375-C10-1XS	REV	
----------------	------------	-----	---	----------------	----------------	-----	--

Mar. 1, 2023 - 10:41 AM P:\2021\21-0125-00 - CAD Files\CSD\H1\CUsers\H1\Drawings\Production\000_Design\Sections\21-0125-1000XS-C20A1

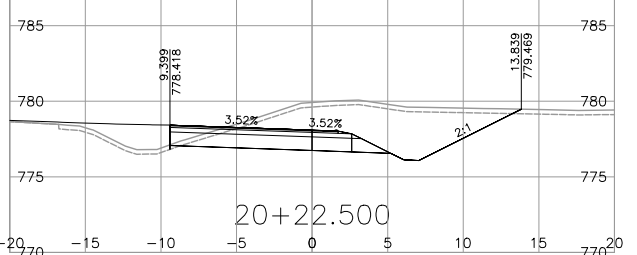
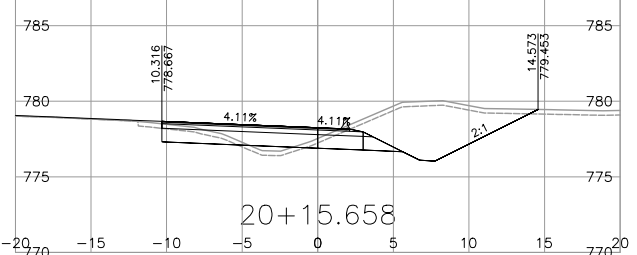
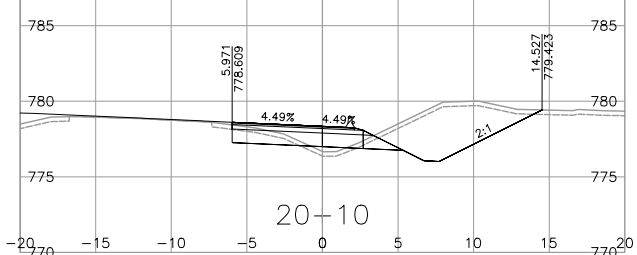
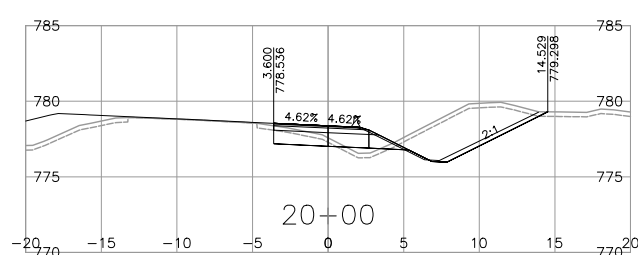
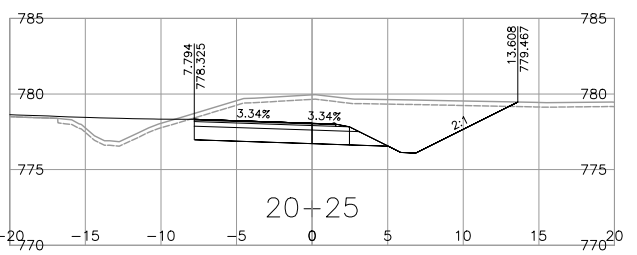
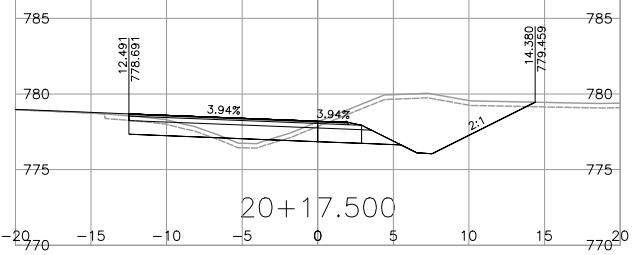
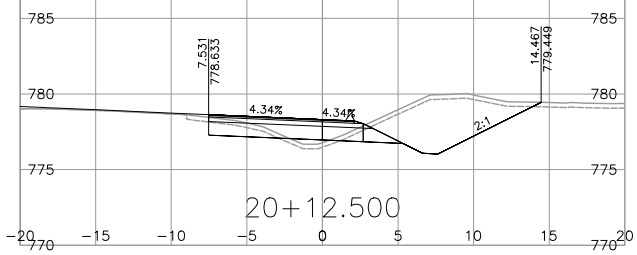
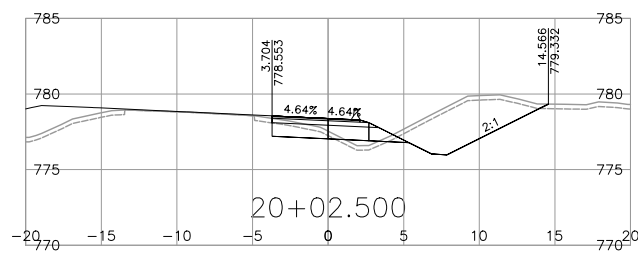
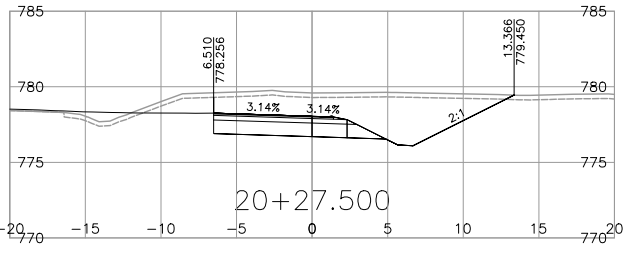
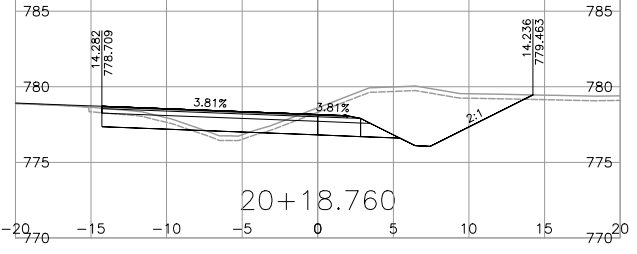
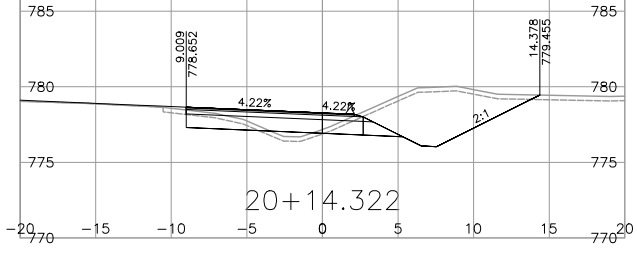
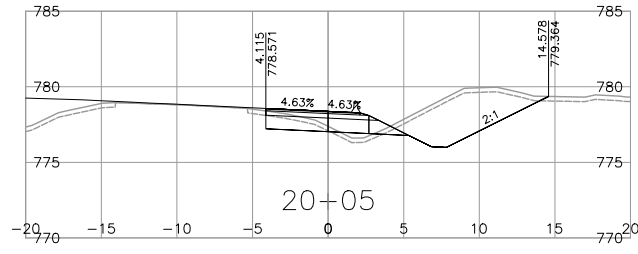
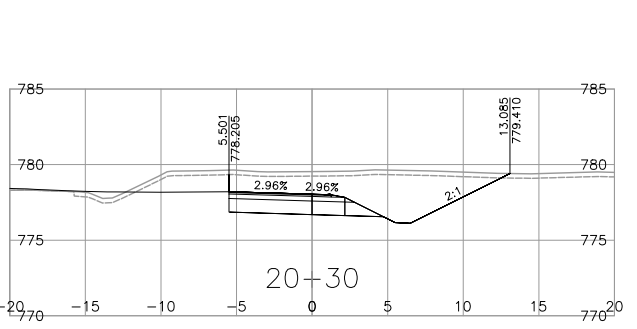
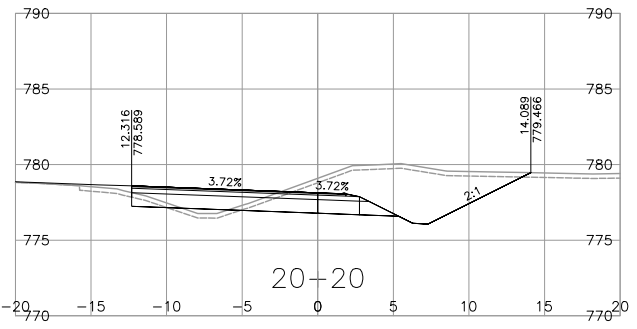
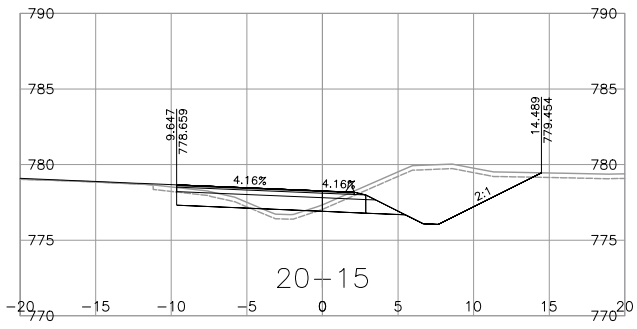
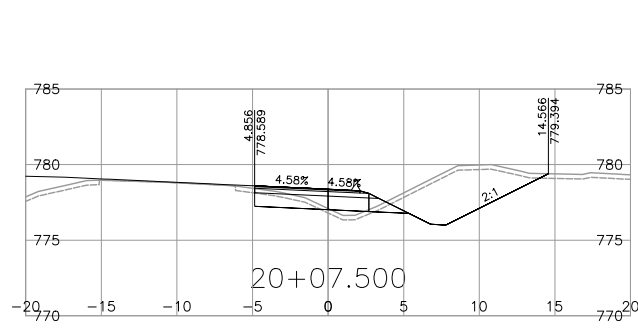

NOTE: STRIPPING REMOVAL APPLIES ONLY TO THE AREA BETWEEN SLOPE STAKE LINES (TOES & TOP OF CUT) OF PROPOSED ROADWAY TEMPLATE

FOR REFERENCE ONLY

DRAFT

FOR INFORMATION ONLY MARCH 03, 2023



BINNIE
The people behind your infrastructure.

R.F. BINNIE & ASSOCIATES LTD.
101 - 1577 7th Avenue,
Prince George, BC V2L 3P5
TEL 250 561 7274
BINNIE.com



BRITISH COLUMBIA

MINISTRY OF TRANSPORTATION AND INFRASTRUCTURE
NORTHERN REGION
HIGHWAY ENGINEERING AND GEOMATICS

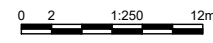
SCALE  CAD FILENAME 21-0125-1000XS-C20A1.DWG
DATE 2023-03-01
FILE NUMBER 21-0125-00

REV	DATE	REVISIONS	SIGNATURE

C20-LINE CROSS SECTIONS
HIGHWAY 16
GUEST ROAD AND SHALLOW BAY ROAD INTERSECTIONS

DESIGNED	_____	R.M.	DATE	_____	MAR. 2023
QUALITY CONTROL	_____	K.T.	DATE	_____	MAR. 2023
QUALITY ASSURANCE	_____	R.M.	DATE	_____	MAR. 2023
DRAWN	_____	J.D.	DATE	_____	MAR. 2023

PROJECT NUMBER	38199-0000	REG	3	DRAWING NUMBER	R3-375-C20-1XS
ENGINEER OF RECORD	R. Mankowske	DATE	20230303	REV	

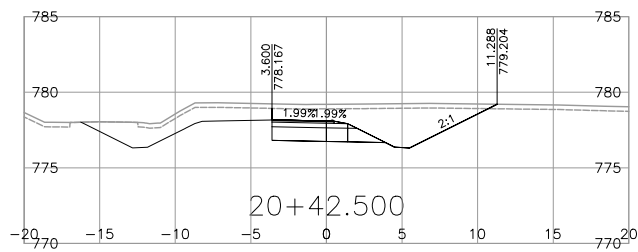
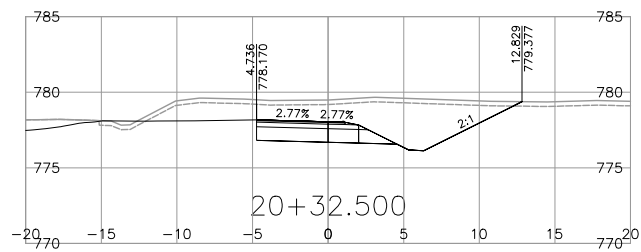
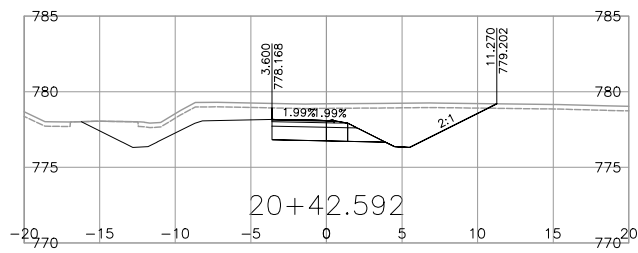
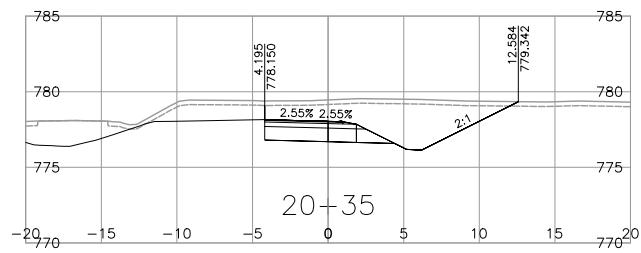
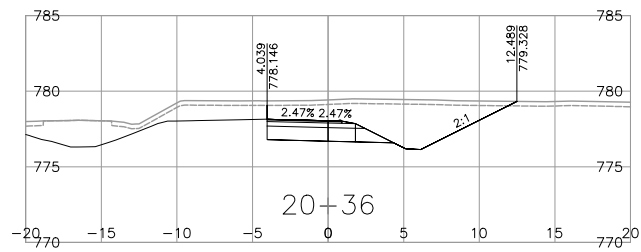
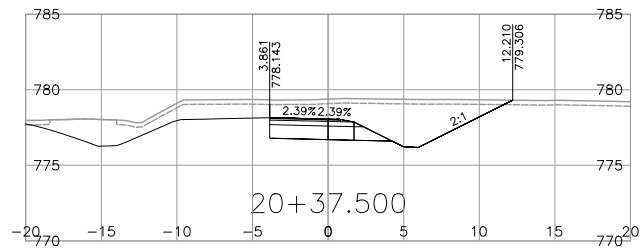
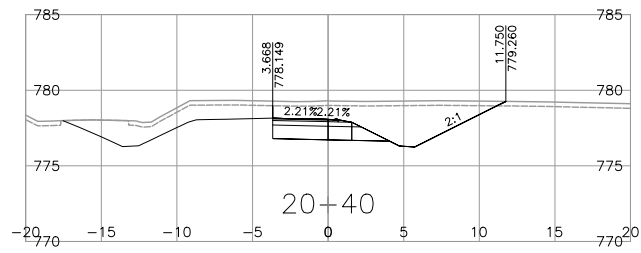

NOTE: STRIPPING REMOVAL APPLIES ONLY TO THE AREA BETWEEN SLOPE STAKE LINES (TOES & TOP OF CUT) OF PROPOSED ROADWAY TEMPLATE

FOR REFERENCE ONLY

DRAFT

FOR INFORMATION ONLY MARCH 03, 2023

<p>BINNIE The people behind your infrastructure.</p>	<p>R.F. BINNIE & ASSOCIATES LTD. 101 - 1577 7th Avenue, Prince George, BC V2L 3P5 TEL 250 561 7274 BINNIE.com</p>	<p>BRITISH COLUMBIA</p>	<p>MINISTRY OF TRANSPORTATION AND INFRASTRUCTURE NORTHERN REGION HIGHWAY ENGINEERING AND GEOMATICS</p>																																												
				<p>SCALE 0 2 1:250 12m</p> <p>CAD FILENAME 21-0125-1000XS-C20A1.DWG DATE 2023-03-01 FILE NUMBER 21-0125-00</p>																																											
<table border="1"> <thead> <tr> <th>REV</th> <th>DATE</th> <th>REVISIONS</th> <th>SIGNATURE</th> </tr> </thead> <tbody> <tr><td> </td><td> </td><td> </td><td> </td></tr> <tr><td> </td><td> </td><td> </td><td> </td></tr> <tr><td> </td><td> </td><td> </td><td> </td></tr> <tr><td> </td><td> </td><td> </td><td> </td></tr> <tr><td> </td><td> </td><td> </td><td> </td></tr> <tr><td> </td><td> </td><td> </td><td> </td></tr> <tr><td> </td><td> </td><td> </td><td> </td></tr> <tr><td> </td><td> </td><td> </td><td> </td></tr> <tr><td> </td><td> </td><td> </td><td> </td></tr> <tr><td> </td><td> </td><td> </td><td> </td></tr> </tbody> </table>		REV	DATE	REVISIONS	SIGNATURE																																									<p>C20-LINE CROSS SECTIONS HIGHWAY 16 GUEST ROAD AND SHALLOW BAY ROAD INTERSECTIONS</p>	
REV	DATE	REVISIONS	SIGNATURE																																												
<p>R. Mankowske ENGINEER OF RECORD DATE 20230303</p>		<table border="1"> <tr> <td>DESIGNED</td> <td>_____</td> <td>R.M.</td> <td>DATE</td> <td>MAR_2023</td> </tr> <tr> <td>QUALITY CONTROL</td> <td>_____</td> <td>K.T.</td> <td>DATE</td> <td>MAR_2023</td> </tr> <tr> <td>QUALITY ASSURANCE</td> <td>_____</td> <td>R.M.</td> <td>DATE</td> <td>MAR_2023</td> </tr> <tr> <td>DRAWN</td> <td>_____</td> <td>J.D.</td> <td>DATE</td> <td>MAR_2023</td> </tr> <tr> <td>PROJECT NUMBER</td> <td>38199-0000</td> <td>REG</td> <td>3</td> <td>DRAWING NUMBER</td> </tr> <tr> <td></td> <td></td> <td></td> <td></td> <td>R3-375-C20-2XS</td> </tr> </table>		DESIGNED	_____	R.M.	DATE	MAR_2023	QUALITY CONTROL	_____	K.T.	DATE	MAR_2023	QUALITY ASSURANCE	_____	R.M.	DATE	MAR_2023	DRAWN	_____	J.D.	DATE	MAR_2023	PROJECT NUMBER	38199-0000	REG	3	DRAWING NUMBER					R3-375-C20-2XS														
DESIGNED	_____	R.M.	DATE	MAR_2023																																											
QUALITY CONTROL	_____	K.T.	DATE	MAR_2023																																											
QUALITY ASSURANCE	_____	R.M.	DATE	MAR_2023																																											
DRAWN	_____	J.D.	DATE	MAR_2023																																											
PROJECT NUMBER	38199-0000	REG	3	DRAWING NUMBER																																											
				R3-375-C20-2XS																																											

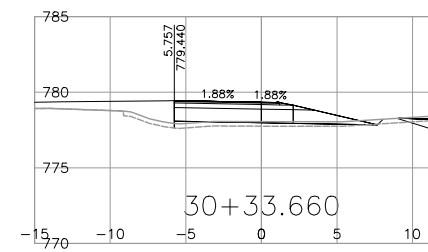
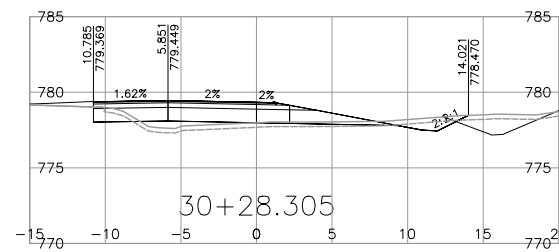
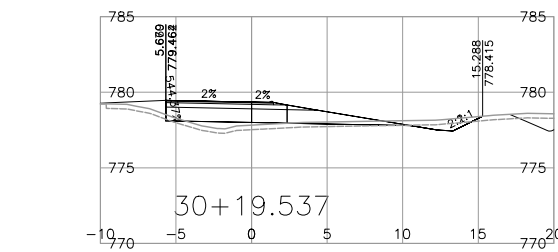
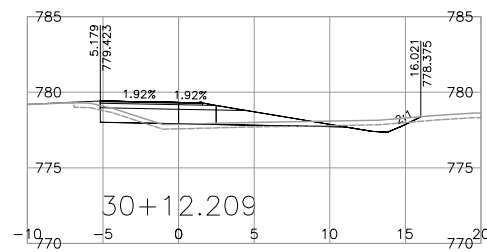
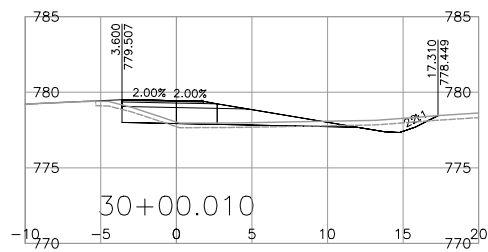
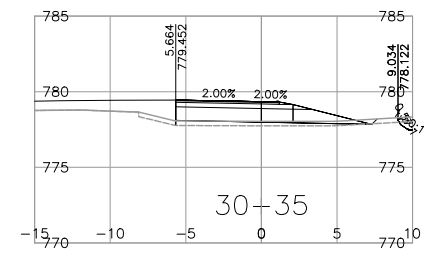
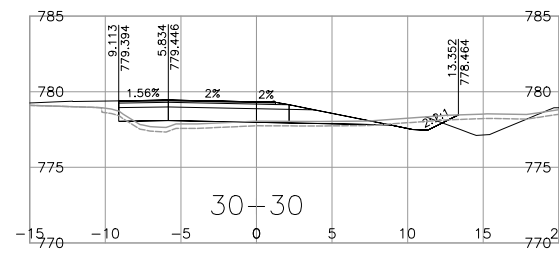
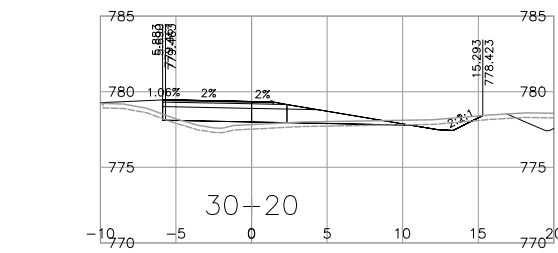
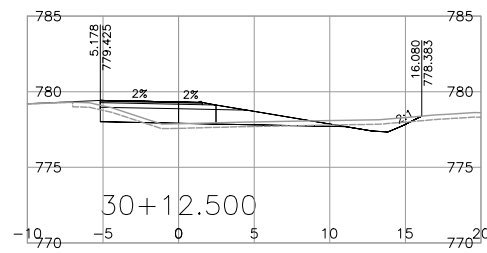
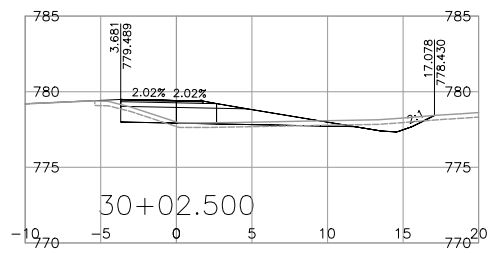
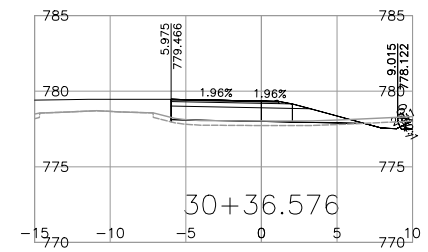
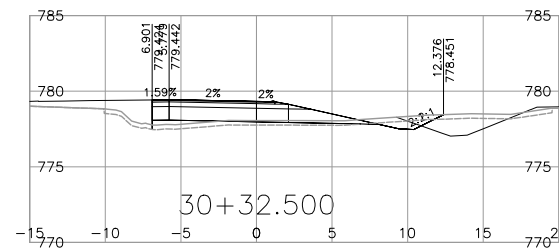
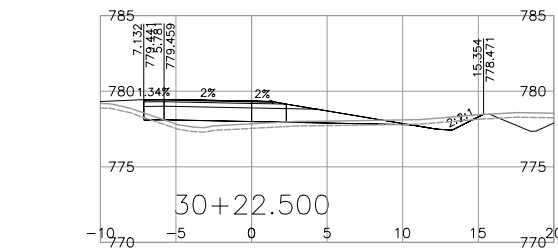
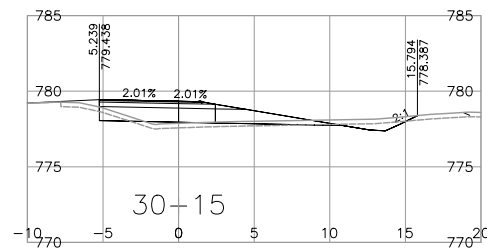
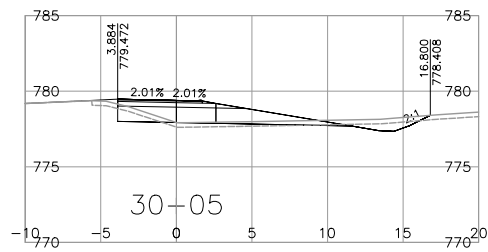
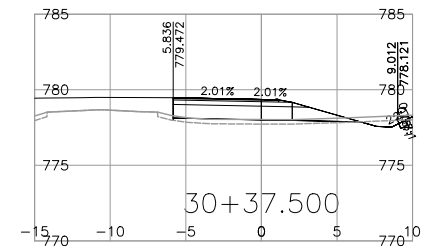
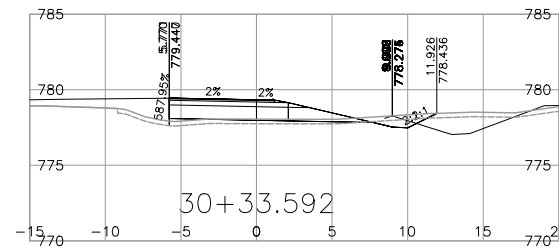
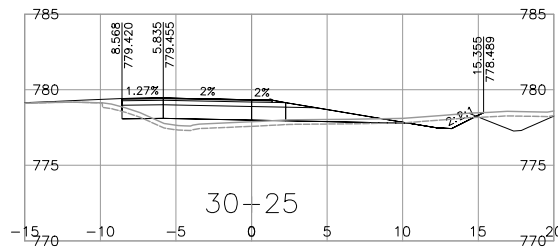
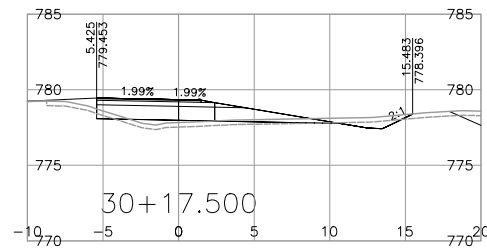
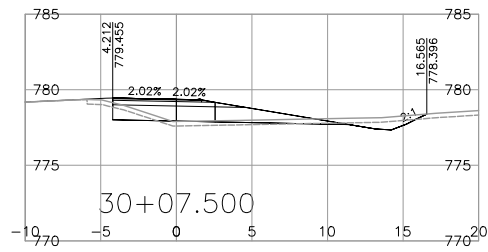
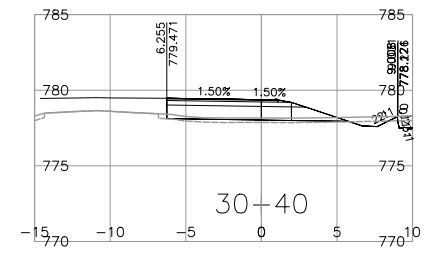
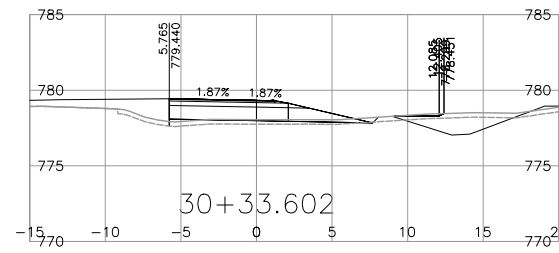
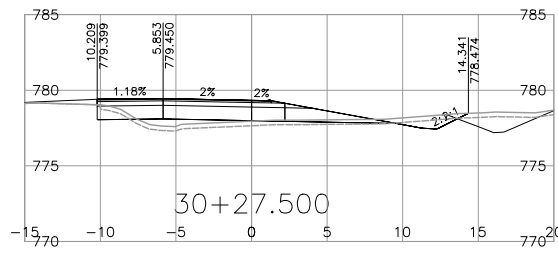
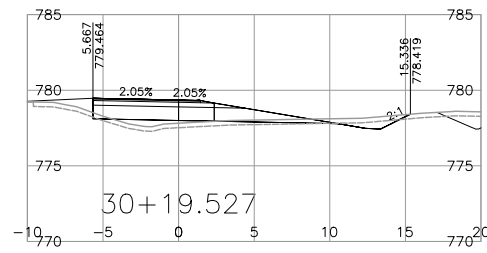
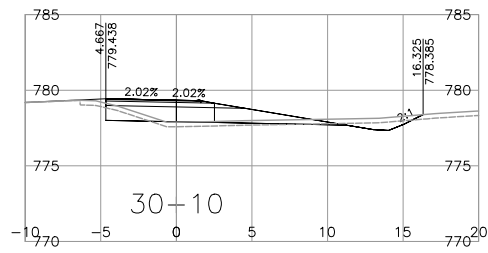

NOTE: STRIPPING REMOVAL APPLIES ONLY TO THE AREA BETWEEN SLOPE STAKE LINES (TOES & TOP OF CUT) OF PROPOSED ROADWAY TEMPLATE

FOR REFERENCE ONLY

DRAFT

FOR INFORMATION ONLY MARCH 03, 2023

BINNIE
The people behind your infrastructure.

R.F. BINNIE & ASSOCIATES LTD.
300 - 4940 Canada Way,
Burnaby, BC V5G 4K6
TEL 604 420 1721
BINNIE.com

BRITISH COLUMBIA
MINISTRY OF TRANSPORTATION AND INFRASTRUCTURE
SOUTH COAST REGION
HIGHWAY ENGINEERING AND GEOMATICS

C30-LINE CROSS SECTIONS
HIGHWAY 16
GUEST ROAD AND SHALLOW BAY ROAD INTERSECTIONS

SCALE 1:250

CAD FILENAME: 21-0125-1000XS-C30A1.DWG
DATE: 2023-03-01
FILE NUMBER: 21-0125-00

REV	DATE	REVISIONS	SIGNATURE

DESIGNED	_____	R.M.	DATE	MAR. 2023
QUALITY CONTROL	_____	K.T.	DATE	MAR. 2023
QUALITY ASSURANCE	_____	R.M.	DATE	MAR. 2023
DRAWN	_____	J.D.	DATE	MAR. 2023
PROJECT NUMBER	38199-0000	REG	3	DRAWING NUMBER
ENGINEER OF RECORD	R. Mankowske	DATE	20230303	R3-375-C30-1XS

Mar. 1, 2023 - 10:47 AM P:\2021\21-0125-00 - CAD Files\C3D-Highway\H1\Drawing\Production\1000_Design\Section\0125-1000XS-C30A1

Mar. 1, 2023 - 10:47 AM P:\2021\21-0125-00 - CAD Files\C3D-Highway\H1\Drawing\Production\000_Design\Sections\21-0125-1000XS-C30A1

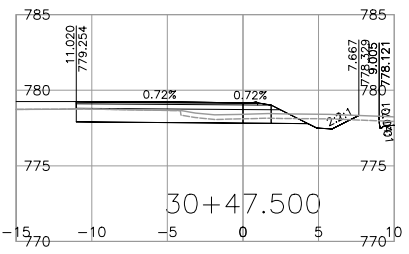
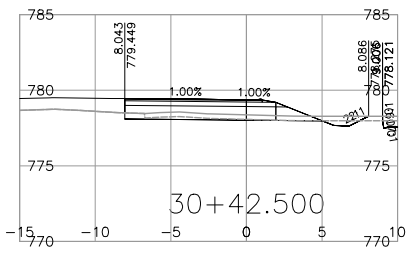
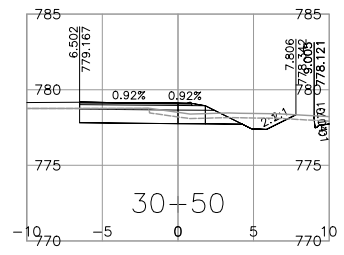
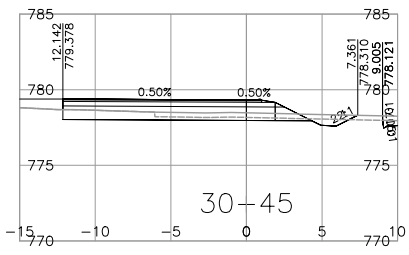
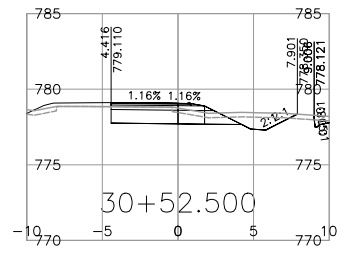
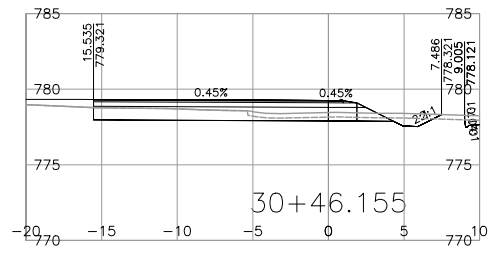
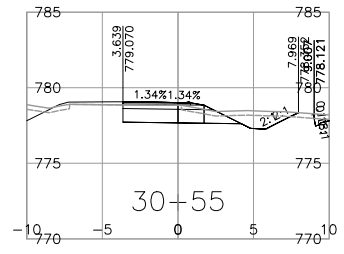
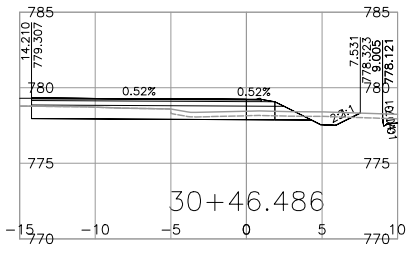
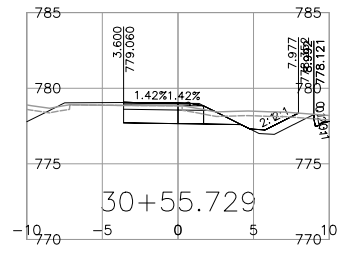
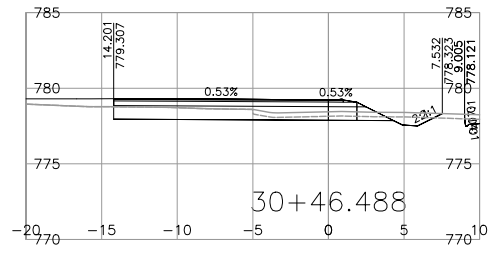

NOTE: STRIPPING REMOVAL APPLIES ONLY TO THE AREA BETWEEN SLOPE STAKE LINES (TOES & TOP OF CUT) OF PROPOSED ROADWAY TEMPLATE

FOR REFERENCE ONLY

DRAFT

FOR INFORMATION ONLY MARCH 03, 2023

<p style="font-size: small;">The people behind your infrastructure.</p>	<p>R.F. BINNIE & ASSOCIATES LTD. 300 - 4940 Canada Way, Burnaby, BC V5G 4K6 TEL 604 420 1721 BINNIE.com</p>	<p style="font-size: small;">MINISTRY OF TRANSPORTATION AND INFRASTRUCTURE SOUTH COAST REGION HIGHWAY ENGINEERING AND GEOMATICS</p>	<p>C30-LINE CROSS SECTIONS HIGHWAY 16 GUEST ROAD AND SHALLOW BAY ROAD INTERSECTIONS</p>																																		
<p>SCALE CAD FILENAME <u>21-0125-1000XS-C30A1.DWG</u> DATE <u>2023-03-01</u> FILE NUMBER <u>21-0125-00</u></p>		<table style="width: 100%; border-collapse: collapse;"> <tr> <td style="width: 25%; border-bottom: 1px solid black;">DESIGNED _____</td> <td style="width: 25%; border-bottom: 1px solid black;">R.M. DATE <u>MAR. 2023</u></td> </tr> <tr> <td style="border-bottom: 1px solid black;">QUALITY CONTROL _____</td> <td style="border-bottom: 1px solid black;">K.T. DATE <u>MAR. 2023</u></td> </tr> <tr> <td style="border-bottom: 1px solid black;">QUALITY ASSURANCE _____</td> <td style="border-bottom: 1px solid black;">R.M. DATE <u>MAR. 2023</u></td> </tr> <tr> <td style="border-bottom: 1px solid black;">DRAWN _____</td> <td style="border-bottom: 1px solid black;">J.D. DATE <u>MAR. 2023</u></td> </tr> </table>		DESIGNED _____	R.M. DATE <u>MAR. 2023</u>	QUALITY CONTROL _____	K.T. DATE <u>MAR. 2023</u>	QUALITY ASSURANCE _____	R.M. DATE <u>MAR. 2023</u>	DRAWN _____	J.D. DATE <u>MAR. 2023</u>																										
DESIGNED _____	R.M. DATE <u>MAR. 2023</u>																																				
QUALITY CONTROL _____	K.T. DATE <u>MAR. 2023</u>																																				
QUALITY ASSURANCE _____	R.M. DATE <u>MAR. 2023</u>																																				
DRAWN _____	J.D. DATE <u>MAR. 2023</u>																																				
<table border="1" style="width: 100%; border-collapse: collapse;"> <thead> <tr> <th style="width: 10%;">REV</th> <th style="width: 10%;">DATE</th> <th style="width: 60%;">REVISIONS</th> <th style="width: 20%;">SIGNATURE</th> </tr> </thead> <tbody> <tr><td> </td><td> </td><td> </td><td> </td></tr> <tr><td> </td><td> </td><td> </td><td> </td></tr> <tr><td> </td><td> </td><td> </td><td> </td></tr> <tr><td> </td><td> </td><td> </td><td> </td></tr> <tr><td> </td><td> </td><td> </td><td> </td></tr> </tbody> </table>		REV	DATE	REVISIONS	SIGNATURE																					<table style="width: 100%; border-collapse: collapse;"> <tr> <td style="width: 50%; border-bottom: 1px solid black;">R. Mankowske ENGINEER OF RECORD DATE 20230303</td> <td style="width: 50%; border-bottom: 1px solid black;"> <table style="width: 100%; border-collapse: collapse;"> <tr> <td style="width: 25%; border-bottom: 1px solid black;">PROJECT NUMBER</td> <td style="width: 25%; border-bottom: 1px solid black;">REG</td> <td style="width: 25%; border-bottom: 1px solid black;">DRAWING NUMBER</td> <td style="width: 25%; border-bottom: 1px solid black;">REV</td> </tr> <tr> <td style="border-bottom: 1px solid black;">38199-0000</td> <td style="border-bottom: 1px solid black;">3</td> <td style="border-bottom: 1px solid black;">R3-375-C30-2XS</td> <td style="border-bottom: 1px solid black;"> </td> </tr> </table> </td> </tr> </table>		R. Mankowske ENGINEER OF RECORD DATE 20230303	<table style="width: 100%; border-collapse: collapse;"> <tr> <td style="width: 25%; border-bottom: 1px solid black;">PROJECT NUMBER</td> <td style="width: 25%; border-bottom: 1px solid black;">REG</td> <td style="width: 25%; border-bottom: 1px solid black;">DRAWING NUMBER</td> <td style="width: 25%; border-bottom: 1px solid black;">REV</td> </tr> <tr> <td style="border-bottom: 1px solid black;">38199-0000</td> <td style="border-bottom: 1px solid black;">3</td> <td style="border-bottom: 1px solid black;">R3-375-C30-2XS</td> <td style="border-bottom: 1px solid black;"> </td> </tr> </table>	PROJECT NUMBER	REG	DRAWING NUMBER	REV	38199-0000	3	R3-375-C30-2XS	
REV	DATE	REVISIONS	SIGNATURE																																		
R. Mankowske ENGINEER OF RECORD DATE 20230303	<table style="width: 100%; border-collapse: collapse;"> <tr> <td style="width: 25%; border-bottom: 1px solid black;">PROJECT NUMBER</td> <td style="width: 25%; border-bottom: 1px solid black;">REG</td> <td style="width: 25%; border-bottom: 1px solid black;">DRAWING NUMBER</td> <td style="width: 25%; border-bottom: 1px solid black;">REV</td> </tr> <tr> <td style="border-bottom: 1px solid black;">38199-0000</td> <td style="border-bottom: 1px solid black;">3</td> <td style="border-bottom: 1px solid black;">R3-375-C30-2XS</td> <td style="border-bottom: 1px solid black;"> </td> </tr> </table>	PROJECT NUMBER	REG	DRAWING NUMBER	REV	38199-0000	3	R3-375-C30-2XS																													
PROJECT NUMBER	REG	DRAWING NUMBER	REV																																		
38199-0000	3	R3-375-C30-2XS																																			

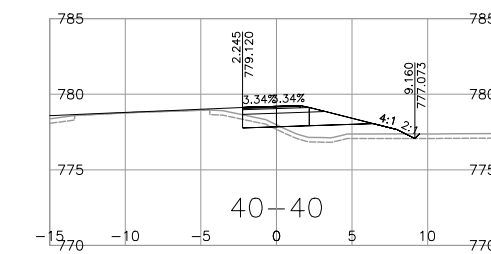
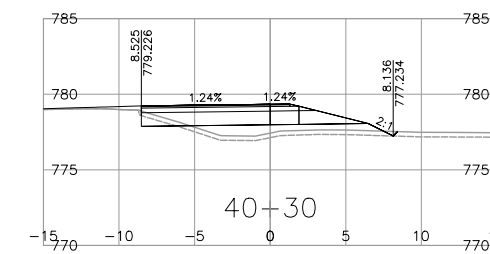
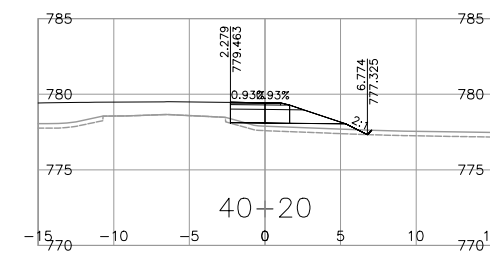
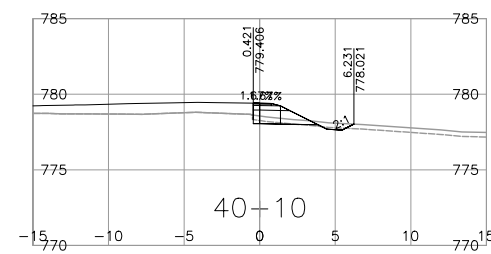
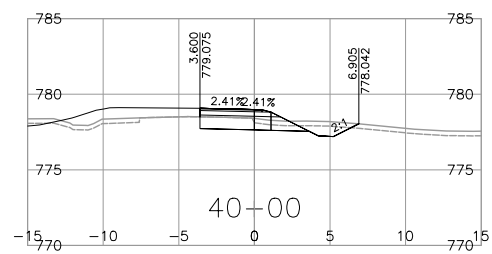
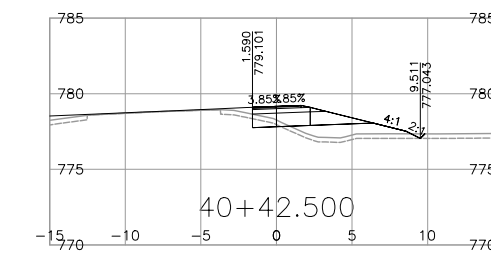
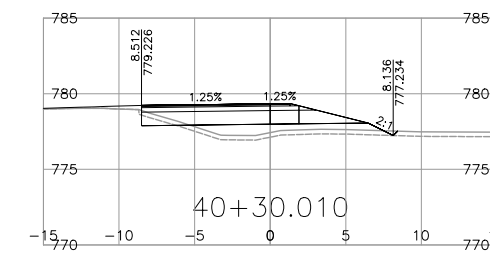
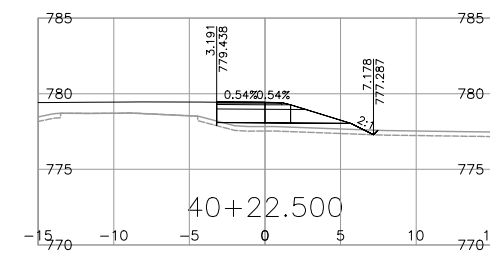
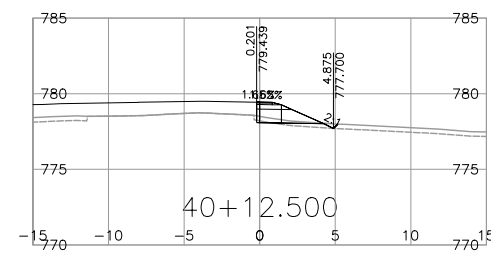
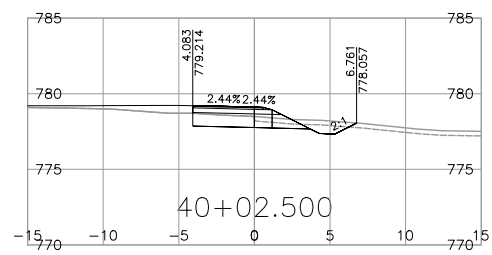
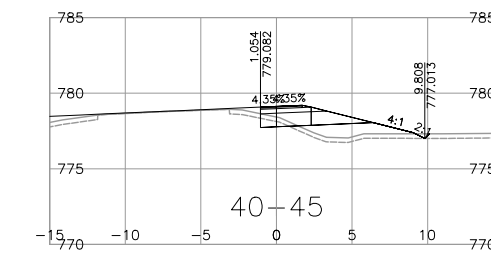
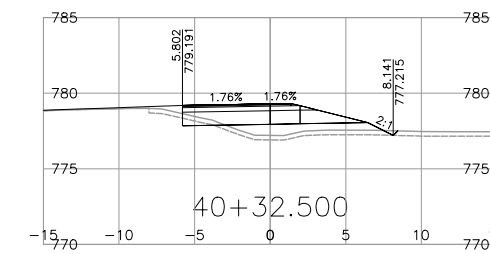
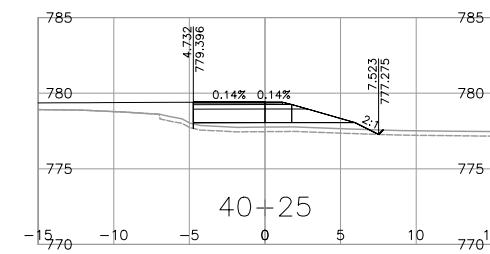
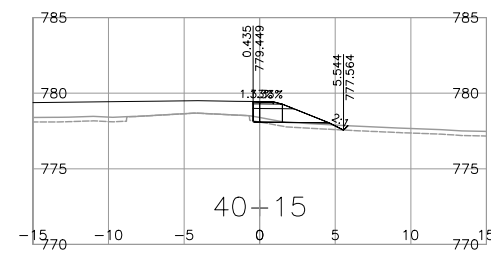
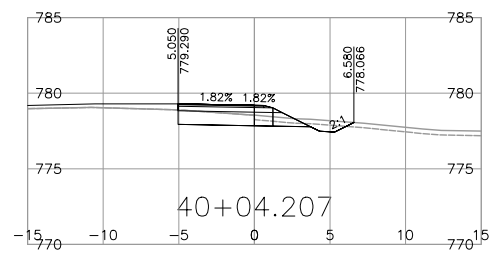
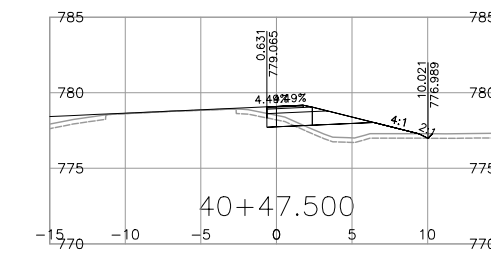
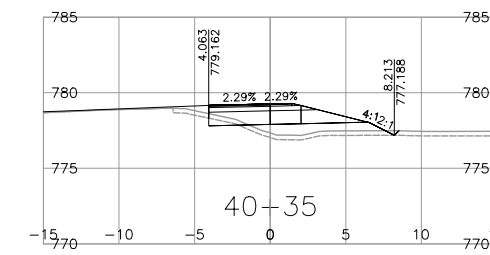
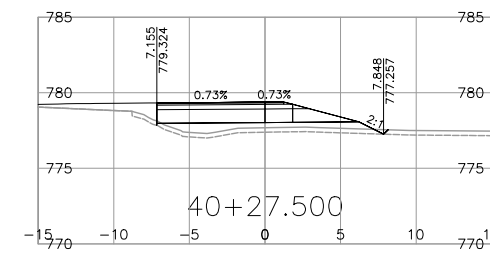
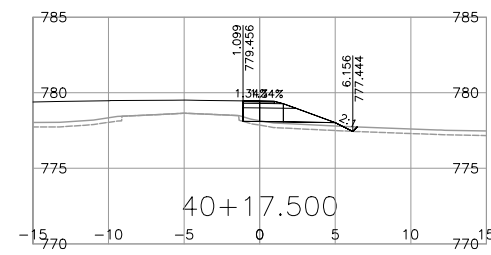
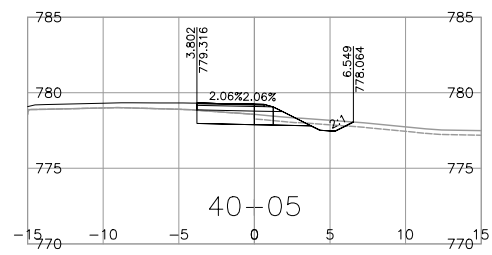
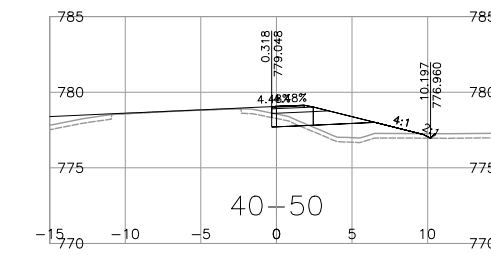
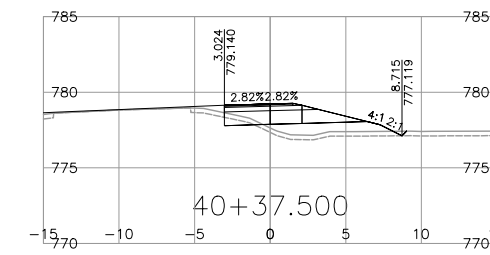
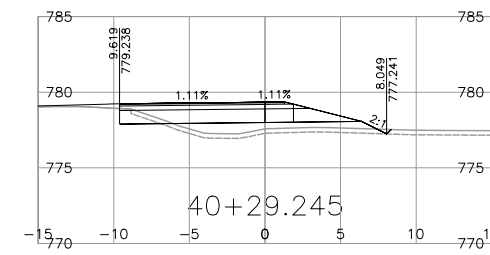
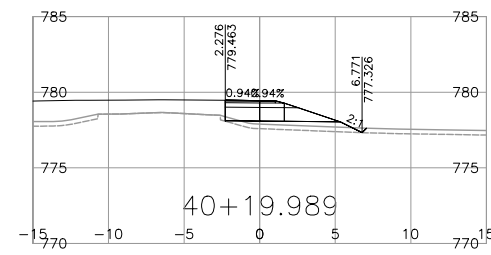
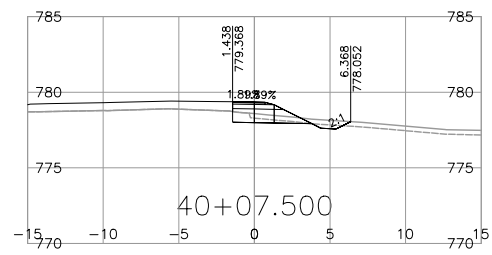

NOTE: STRIPPING REMOVAL APPLIES ONLY TO THE AREA BETWEEN SLOPE STAKE LINES (TOES & TOP OF CUT) OF PROPOSED ROADWAY TEMPLATE

FOR REFERENCE ONLY

DRAFT

FOR INFORMATION ONLY MARCH 03, 2023

BINNIE
The people behind your infrastructure.

R.F. BINNIE & ASSOCIATES LTD.
101 - 1577 7th Avenue,
Prince George, BC V2L 3P5
TEL 250 561 7274
BINNIE.com

BRITISH COLUMBIA

MINISTRY OF TRANSPORTATION AND INFRASTRUCTURE
NORTHERN REGION
HIGHWAY ENGINEERING AND GEOMATICS

C40-LINE CROSS SECTIONS
HIGHWAY 16
GUEST ROAD AND SHALLOW BAY ROAD INTERSECTIONS

SCALE 0 2 1:250 12m

CAD FILENAME 21-0125-1000XS-C40A1.DWG
DATE 2023-03-01
FILE NUMBER 21-0125-00

REV	DATE	REVISIONS	SIGNATURE

DESIGNED	_____	R.M.	DATE	MAR_2023
QUALITY CONTROL	_____	K.T.	DATE	MAR_2023
QUALITY ASSURANCE	_____	R.M.	DATE	MAR_2023
DRAWN	_____	J.D.	DATE	MAR_2023
PROJECT NUMBER	38199-0000	REG	3	DRAWING NUMBER
				R3-375-C40-1XS

R. Mankowske
ENGINEER OF RECORD
DATE 20230303

Mar 1, 2023 - 10:50 AM P:\2021\21-0125-00 - CAD Files\CAD\H1\CrossR1\DrawingProduction\000_Design\Sections\0125-1000XS-C40A1

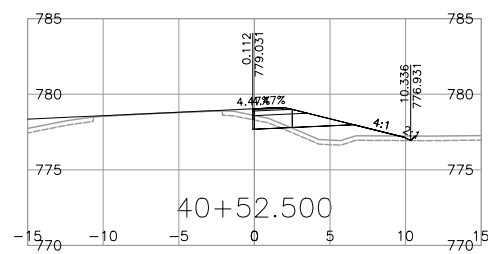
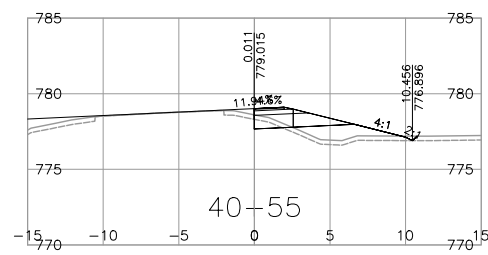
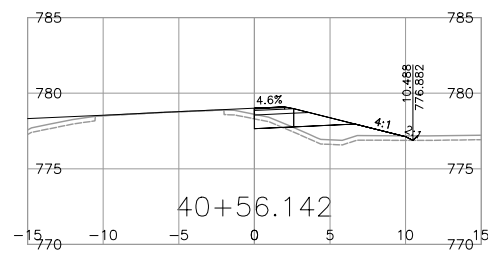



NOTE: STRIPPING REMOVAL APPLIES ONLY TO THE AREA BETWEEN SLOPE STAKE LINES (TOES & TOP OF CUT) OF PROPOSED ROADWAY TEMPLATE

FOR REFERENCE ONLY

DRAFT

FOR INFORMATION ONLY MARCH 03, 2023

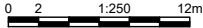
 The people behind your infrastructure.	R.F. BINNIE & ASSOCIATES LTD. 101 - 1577 7th Avenue, Prince George, BC V2L 3P5 TEL 250 561 7274 BINNIE.com	 BRITISH COLUMBIA	MINISTRY OF TRANSPORTATION AND INFRASTRUCTURE NORTHERN REGION HIGHWAY ENGINEERING AND GEOMATICS																																				
			C40-LINE CROSS SECTIONS HIGHWAY 16 GUEST ROAD AND SHALLOW BAY ROAD INTERSECTIONS																																				
SCALE  CAD FILENAME 21-0125-1000XS-C40A1.DWG DATE 2023-03-01 FILE NUMBER 21-0125-00		DESIGNED _____ R.M. DATE MAR_2023 QUALITY CONTROL _____ K.T. DATE MAR_2023 QUALITY ASSURANCE _____ R.M. DATE MAR_2023 DRAWN _____ J.D. DATE MAR_2023																																					
<table border="1"> <thead> <tr> <th>REV</th> <th>DATE</th> <th>REVISIONS</th> <th>SIGNATURE</th> </tr> </thead> <tbody> <tr><td> </td><td> </td><td> </td><td> </td></tr> <tr><td> </td><td> </td><td> </td><td> </td></tr> <tr><td> </td><td> </td><td> </td><td> </td></tr> <tr><td> </td><td> </td><td> </td><td> </td></tr> <tr><td> </td><td> </td><td> </td><td> </td></tr> <tr><td> </td><td> </td><td> </td><td> </td></tr> <tr><td> </td><td> </td><td> </td><td> </td></tr> <tr><td> </td><td> </td><td> </td><td> </td></tr> </tbody> </table>		REV	DATE	REVISIONS	SIGNATURE																																	PROJECT NUMBER 38199-0000 REG 3 DRAWING NUMBER R3-375-C40-2XS REV ENGINEER OF RECORD R. Mankowski DATE 20230303	
REV	DATE	REVISIONS	SIGNATURE																																				

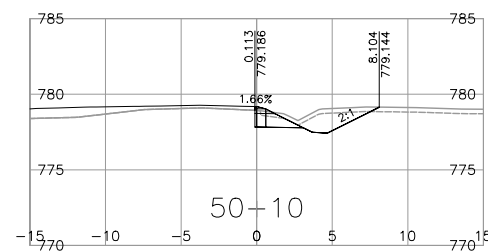
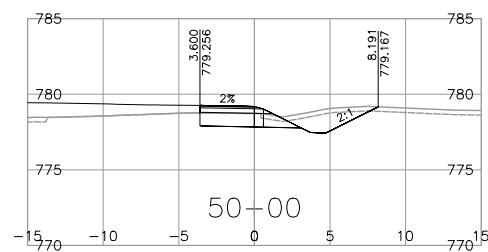
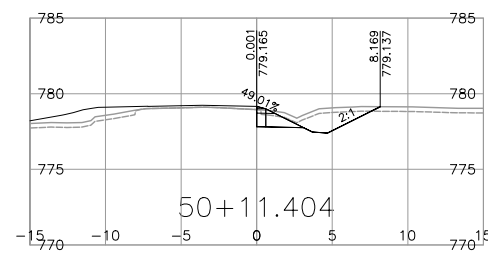
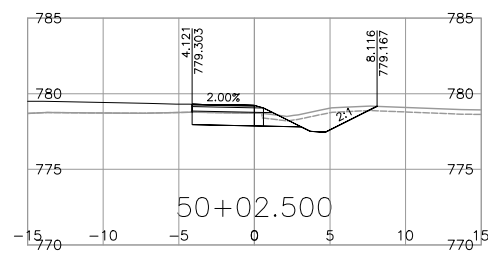
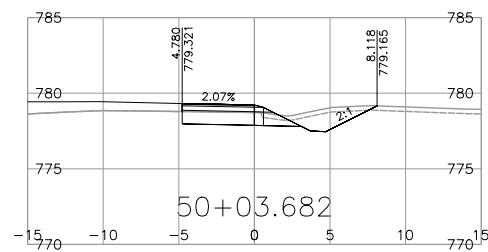
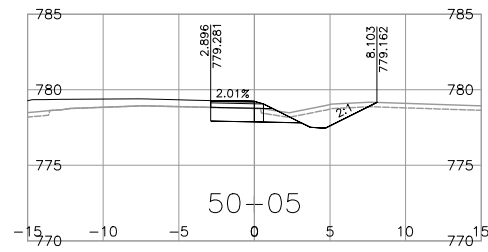
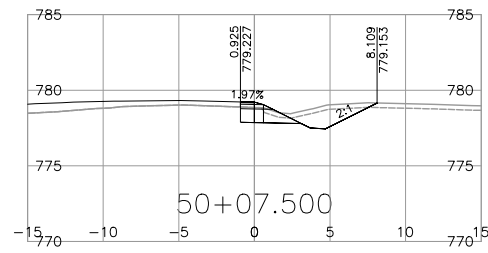

NOTE: STRIPPING REMOVAL APPLIES ONLY TO THE AREA BETWEEN SLOPE STAKE LINES (TOES & TOP OF CUT) OF PROPOSED ROADWAY TEMPLATE

FOR REFERENCE ONLY

DRAFT

FOR INFORMATION ONLY MARCH 03, 2023

<p>BINNIE The people behind your infrastructure.</p>	<p>R.F. BINNIE & ASSOCIATES LTD. 101 - 1577 7th Avenue, Prince George, BC V2L 3P5 TEL 250 561 7274 BINNIE.com</p>	<p>BRITISH COLUMBIA</p>	<p>MINISTRY OF TRANSPORTATION AND INFRASTRUCTURE NORTHERN REGION HIGHWAY ENGINEERING AND GEOMATICS</p>																																								
				<p>SCALE 0 2 1:250 12m</p> <p>CAD FILENAME 21-0125-1000XS-C50A1.DWG DATE 2023-03-01 FILE NUMBER 21-0125-00</p>																																							
<table border="1"> <thead> <tr> <th>REV</th> <th>DATE</th> <th>REVISIONS</th> <th>SIGNATURE</th> </tr> </thead> <tbody> <tr><td> </td><td> </td><td> </td><td> </td></tr> <tr><td> </td><td> </td><td> </td><td> </td></tr> <tr><td> </td><td> </td><td> </td><td> </td></tr> <tr><td> </td><td> </td><td> </td><td> </td></tr> <tr><td> </td><td> </td><td> </td><td> </td></tr> <tr><td> </td><td> </td><td> </td><td> </td></tr> <tr><td> </td><td> </td><td> </td><td> </td></tr> <tr><td> </td><td> </td><td> </td><td> </td></tr> <tr><td> </td><td> </td><td> </td><td> </td></tr> </tbody> </table>		REV	DATE	REVISIONS	SIGNATURE																																					<p>C50-LINE CROSS SECTIONS HIGHWAY 16 GUEST ROAD AND SHALLOW BAY ROAD INTERSECTIONS</p>	
REV	DATE	REVISIONS	SIGNATURE																																								
<p>R. Mankowske ENGINEER OF RECORD DATE 20230303</p>		<table border="1"> <tr> <td>DESIGNED</td> <td>_____</td> <td>R.M.</td> <td>DATE</td> <td>_____</td> <td>MAR_2023</td> </tr> <tr> <td>QUALITY CONTROL</td> <td>_____</td> <td>K.T.</td> <td>DATE</td> <td>_____</td> <td>MAR_2023</td> </tr> <tr> <td>QUALITY ASSURANCE</td> <td>_____</td> <td>R.M.</td> <td>DATE</td> <td>_____</td> <td>MAR_2023</td> </tr> <tr> <td>DRAWN</td> <td>_____</td> <td>J.D.</td> <td>DATE</td> <td>_____</td> <td>MAR_2023</td> </tr> <tr> <td>PROJECT NUMBER</td> <td>38199-0000</td> <td>REG</td> <td>3</td> <td>DRAWING NUMBER</td> <td>R3-375-C50-1XS</td> </tr> </table>		DESIGNED	_____	R.M.	DATE	_____	MAR_2023	QUALITY CONTROL	_____	K.T.	DATE	_____	MAR_2023	QUALITY ASSURANCE	_____	R.M.	DATE	_____	MAR_2023	DRAWN	_____	J.D.	DATE	_____	MAR_2023	PROJECT NUMBER	38199-0000	REG	3	DRAWING NUMBER	R3-375-C50-1XS										
DESIGNED	_____	R.M.	DATE	_____	MAR_2023																																						
QUALITY CONTROL	_____	K.T.	DATE	_____	MAR_2023																																						
QUALITY ASSURANCE	_____	R.M.	DATE	_____	MAR_2023																																						
DRAWN	_____	J.D.	DATE	_____	MAR_2023																																						
PROJECT NUMBER	38199-0000	REG	3	DRAWING NUMBER	R3-375-C50-1XS																																						

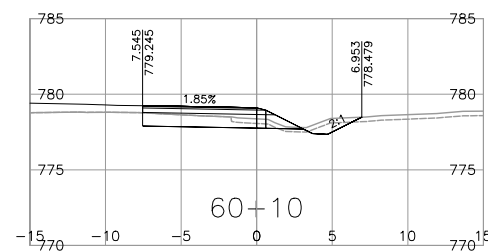
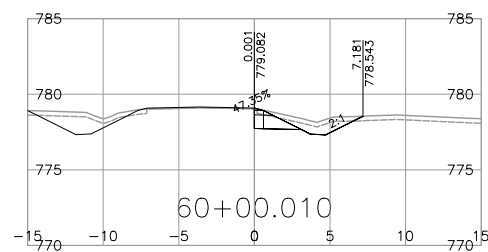
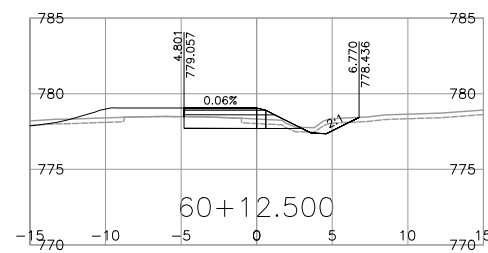
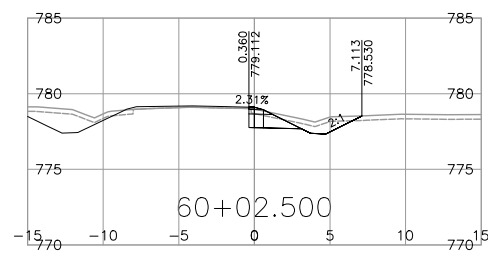
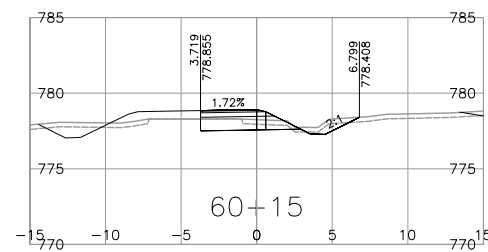
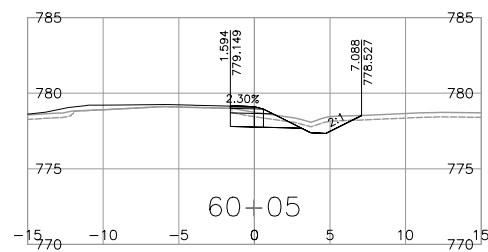
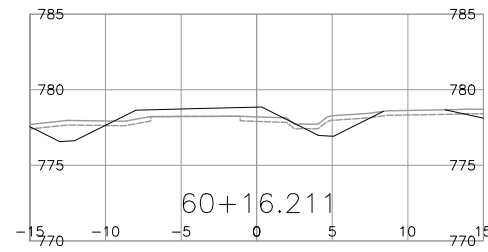
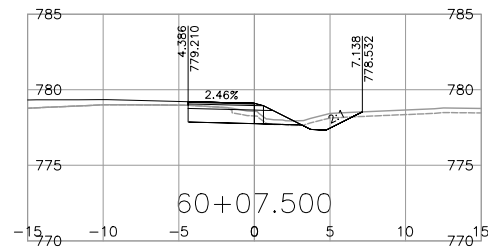
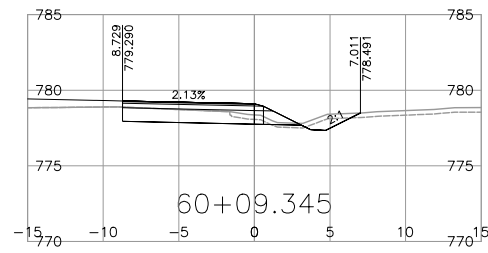

NOTE: STRIPPING REMOVAL APPLIES ONLY TO THE AREA BETWEEN SLOPE STAKE LINES (TOES & TOP OF CUT) OF PROPOSED ROADWAY TEMPLATE

FOR REFERENCE ONLY

DRAFT

FOR INFORMATION ONLY MARCH 03, 2023

<p>BINNIE The people behind your infrastructure.</p>	<p>R.F. BINNIE & ASSOCIATES LTD. 101 - 1577 7th Avenue, Prince George, BC V2L 3P5 TEL 250 561 7274 BINNIE.com</p>	<p>BRITISH COLUMBIA</p>	<p>MINISTRY OF TRANSPORTATION AND INFRASTRUCTURE NORTHERN REGION HIGHWAY ENGINEERING AND GEOMATICS</p>																																								
				<p>SCALE 0 2 1:250 12m</p> <p>CAD FILENAME 21-0125-1000XS-C60A1.DWG DATE 2023-03-01 FILE NUMBER 21-0125-00</p>																																							
<table border="1"> <thead> <tr> <th>REV</th> <th>DATE</th> <th>REVISIONS</th> <th>SIGNATURE</th> </tr> </thead> <tbody> <tr><td> </td><td> </td><td> </td><td> </td></tr> <tr><td> </td><td> </td><td> </td><td> </td></tr> <tr><td> </td><td> </td><td> </td><td> </td></tr> <tr><td> </td><td> </td><td> </td><td> </td></tr> <tr><td> </td><td> </td><td> </td><td> </td></tr> <tr><td> </td><td> </td><td> </td><td> </td></tr> <tr><td> </td><td> </td><td> </td><td> </td></tr> <tr><td> </td><td> </td><td> </td><td> </td></tr> <tr><td> </td><td> </td><td> </td><td> </td></tr> </tbody> </table>		REV	DATE	REVISIONS	SIGNATURE																																					<p>C60-LINE CROSS SECTIONS HIGHWAY 16 GUEST ROAD AND SHALLOW BAY ROAD INTERSECTIONS</p>	
REV	DATE	REVISIONS	SIGNATURE																																								
<p>R. Mankowske ENGINEER OF RECORD DATE 20230303</p>		<table border="1"> <tr> <td>DESIGNED</td> <td>_____</td> <td>R.M.</td> <td>DATE</td> <td>_____</td> <td>MAR. 2023</td> </tr> <tr> <td>QUALITY CONTROL</td> <td>_____</td> <td>K.T.</td> <td>DATE</td> <td>_____</td> <td>MAR. 2023</td> </tr> <tr> <td>QUALITY ASSURANCE</td> <td>_____</td> <td>R.M.</td> <td>DATE</td> <td>_____</td> <td>MAR. 2023</td> </tr> <tr> <td>DRAWN</td> <td>_____</td> <td>J.D.</td> <td>DATE</td> <td>_____</td> <td>MAR. 2023</td> </tr> <tr> <td>PROJECT NUMBER</td> <td>38199-0000</td> <td>REG</td> <td>3</td> <td>DRAWING NUMBER</td> <td>R3-375-C60-1XS</td> </tr> </table>		DESIGNED	_____	R.M.	DATE	_____	MAR. 2023	QUALITY CONTROL	_____	K.T.	DATE	_____	MAR. 2023	QUALITY ASSURANCE	_____	R.M.	DATE	_____	MAR. 2023	DRAWN	_____	J.D.	DATE	_____	MAR. 2023	PROJECT NUMBER	38199-0000	REG	3	DRAWING NUMBER	R3-375-C60-1XS										
DESIGNED	_____	R.M.	DATE	_____	MAR. 2023																																						
QUALITY CONTROL	_____	K.T.	DATE	_____	MAR. 2023																																						
QUALITY ASSURANCE	_____	R.M.	DATE	_____	MAR. 2023																																						
DRAWN	_____	J.D.	DATE	_____	MAR. 2023																																						
PROJECT NUMBER	38199-0000	REG	3	DRAWING NUMBER	R3-375-C60-1XS																																						

Mar. 1, 2023 - 10:55 AM P:\2021\21-0125-00 - CAD Files\CAD\H1\Drawings\Production\000_Design\Sections\0125-1000XS-C70A1

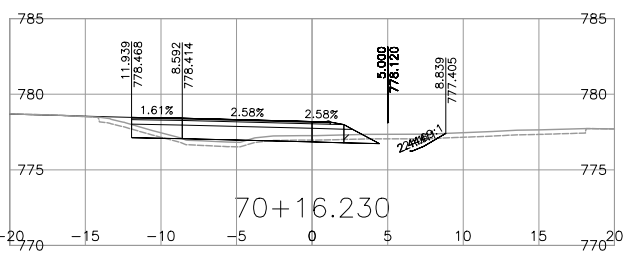
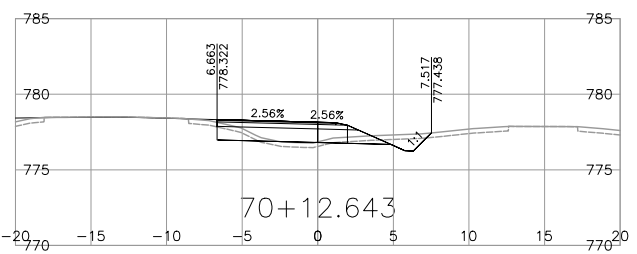
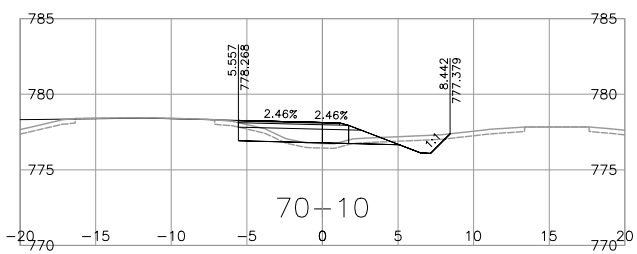
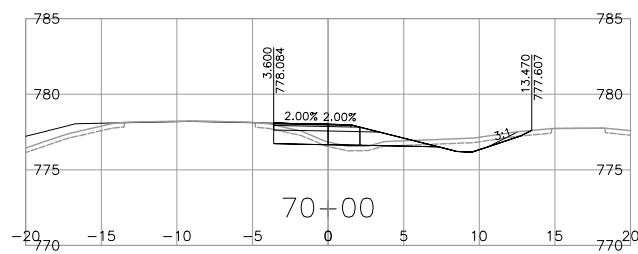
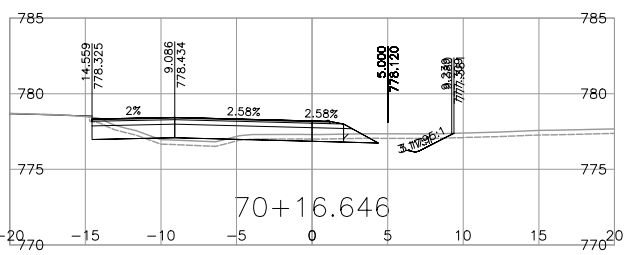
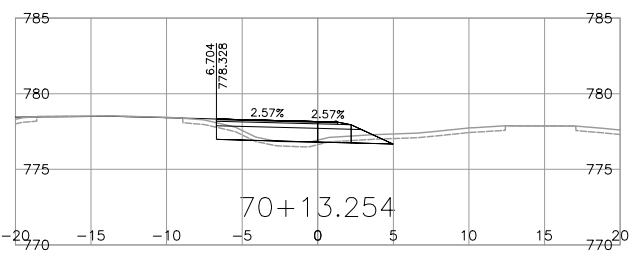
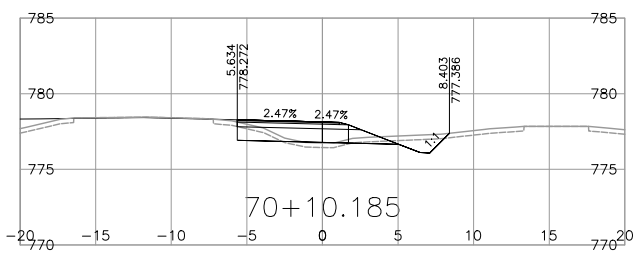
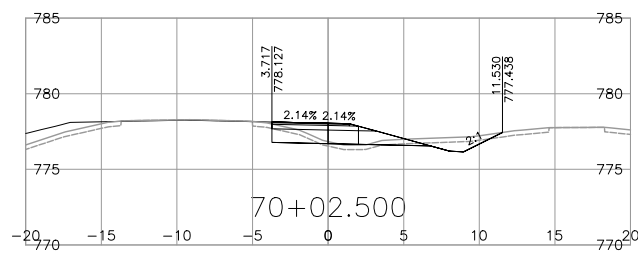
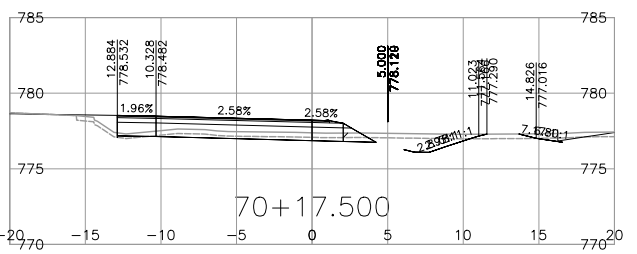
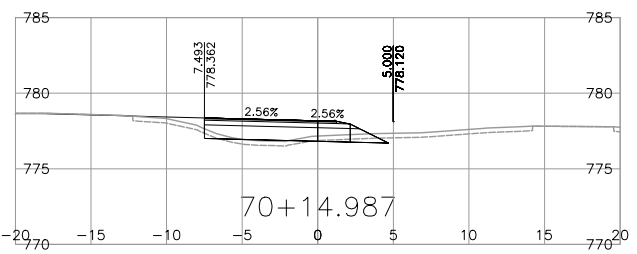
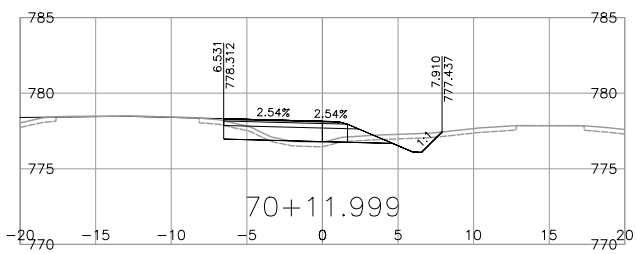
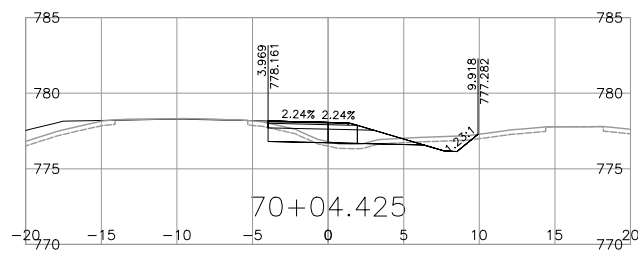
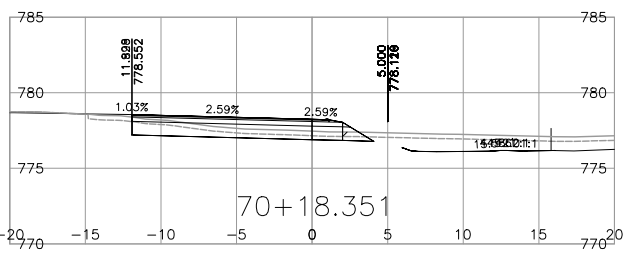
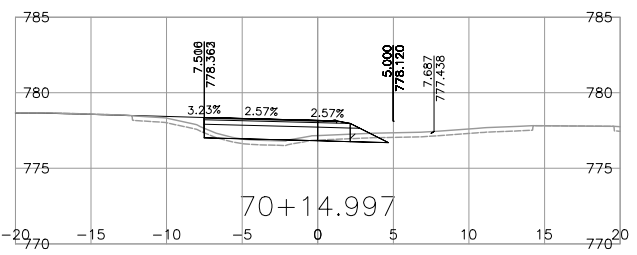
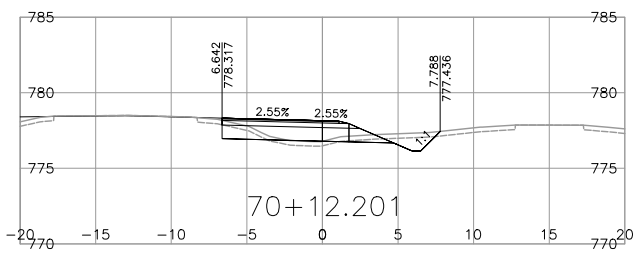
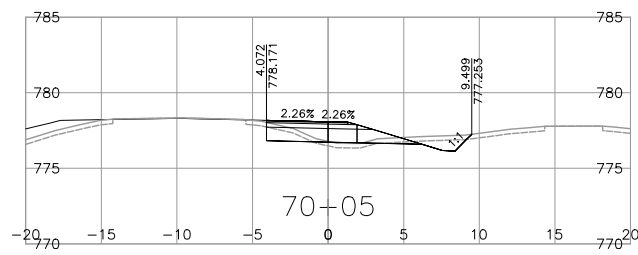
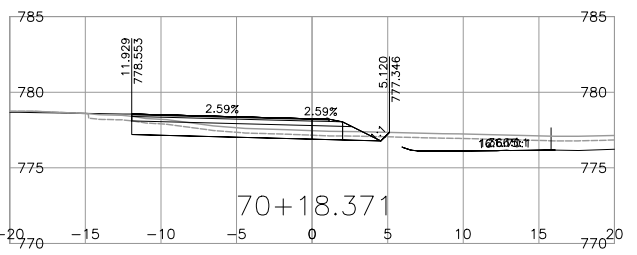
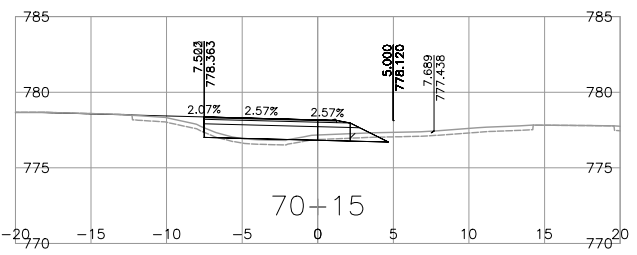
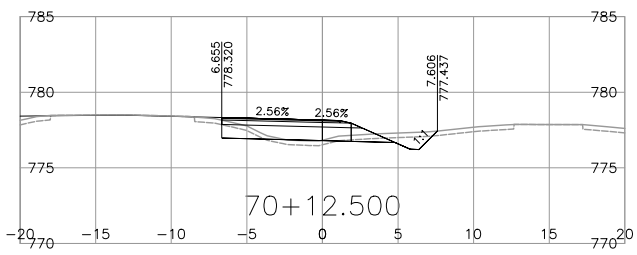
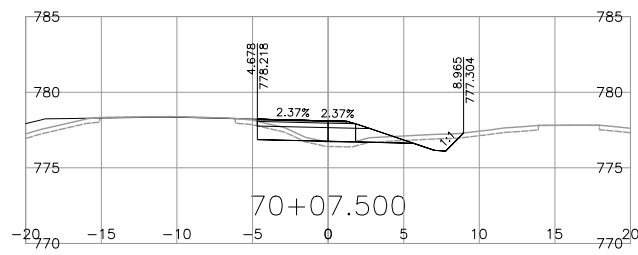

NOTE: STRIPPING REMOVAL APPLIES ONLY TO THE AREA BETWEEN SLOPE STAKE LINES (TOES & TOP OF CUT) OF PROPOSED ROADWAY TEMPLATE

FOR REFERENCE ONLY

DRAFT

FOR INFORMATION ONLY MARCH 03, 2023



R.F. BINNIE & ASSOCIATES LTD.
101 - 1577 7th Avenue,
Prince George, BC V2L 3P5
TEL 250 561 7274
BINNIE.com



BRITISH COLUMBIA

MINISTRY OF TRANSPORTATION AND INFRASTRUCTURE
NORTHERN REGION
HIGHWAY ENGINEERING AND GEOMATICS

CAD FILENAME: 21-0125-1000XS-C70A1.DWG
DATE: 2023-03-01
FILE NUMBER: 21-0125-00

SCALE: 0 2 1:250 12m

REV	DATE	REVISIONS	SIGNATURE

C70-LINE CROSS SECTIONS
HIGHWAY 16
GUEST ROAD AND SHALLOW BAY ROAD INTERSECTIONS

DESIGNED: _____ R.M. DATE: MAR. 2023
QUALITY CONTROL: _____ K.T. DATE: MAR. 2023
QUALITY ASSURANCE: _____ R.M. DATE: MAR. 2023
DRAWN: _____ J.D. DATE: MAR. 2023

PROJECT NUMBER: 38199-0000 REG: 3 DRAWING NUMBER: R3-375-C70-1XS REV: _____

R. Mankowske
ENGINEER OF RECORD
DATE: 20230303

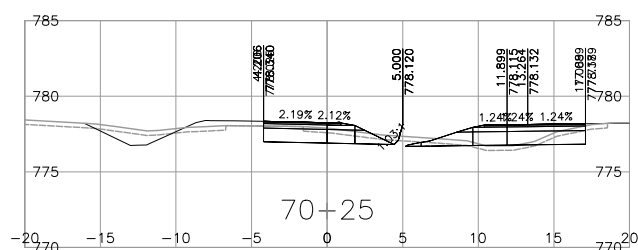
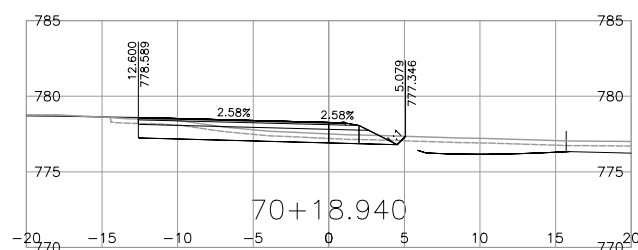
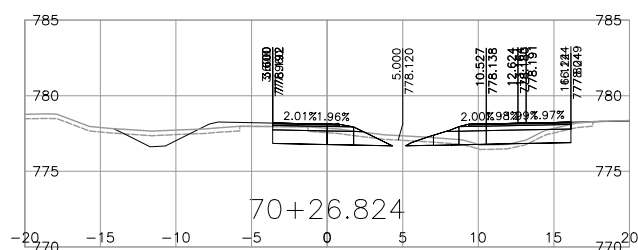
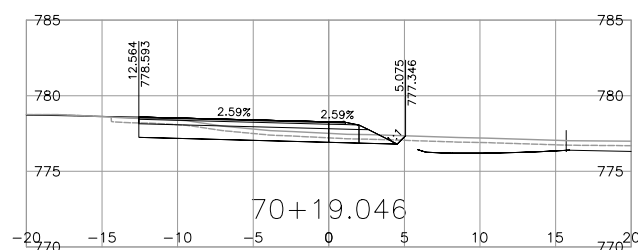
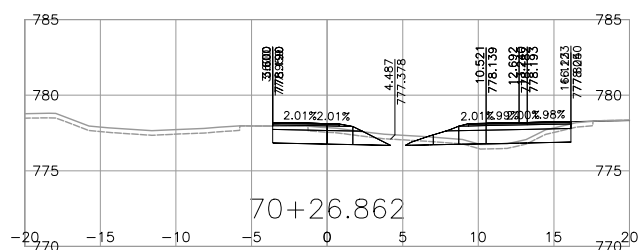
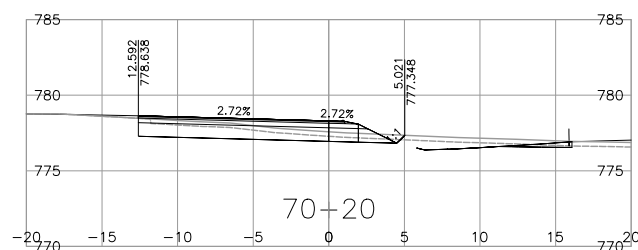
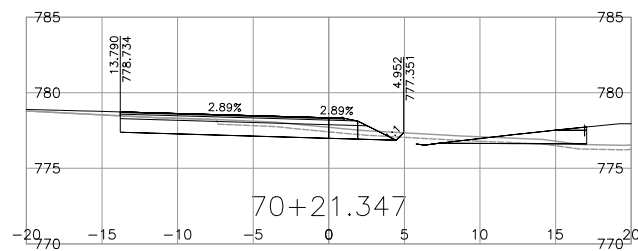
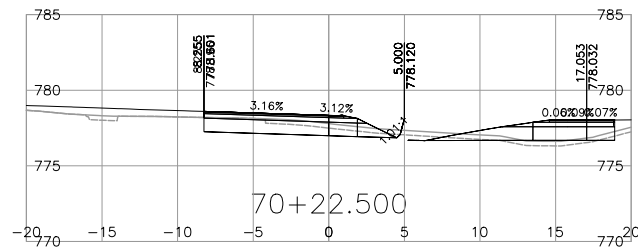

NOTE: STRIPPING REMOVAL APPLIES ONLY TO THE AREA BETWEEN SLOPE STAKE LINES (TOES & TOP OF CUT) OF PROPOSED ROADWAY TEMPLATE

FOR REFERENCE ONLY

DRAFT

FOR INFORMATION ONLY MARCH 03, 2023

BINNIE
The people behind your infrastructure.

R.F. BINNIE & ASSOCIATES LTD.
101 - 1577 7th Avenue,
Prince George, BC V2L 3P5
TEL 250 561 7274
BINNIE.com

BRITISH COLUMBIA
MINISTRY OF TRANSPORTATION AND INFRASTRUCTURE
NORTHERN REGION
HIGHWAY ENGINEERING AND GEOMATICS

SCALE 0 2 1:250 12m
CAD FILENAME 21-0125-1000XS-C70A1.DWG
DATE 2023-03-01
FILE NUMBER 21-0125-00

DRAWING TYPE
HIGHWAY 16
GUEST ROAD AND SHALLOW BAY ROAD INTERSECTIONS

REV	DATE	REVISIONS	SIGNATURE

DESIGNED	R.M.	DATE	MAR 2023
QUALITY CONTROL	K.T.	DATE	MAR 2023
QUALITY ASSURANCE	R.M.	DATE	MAR 2023
DRAWN	J.D.	DATE	MAR 2023
PROJECT NUMBER	REG	DRAWING NUMBER	REV
38199-0000	NOT USE THIS FIELD!	C70-2XS	
R. Mankowske		ENGINEER OF RECORD	
DATE 20230303			

Mar 1, 2023 - 10:56 AM P:\2021\21-0125-00 - CAD Files\CAD-Files\H1-Drawing\Production\1000_Drawing\Sections\91-0125-1000XS-C70A1

Mar. 1, 2023 - 10:57 AM P:\2021\21-0125-00 - CAD Files\CAD-Highway\Production\000_Design\Sections\0125-1000XS-C80A1

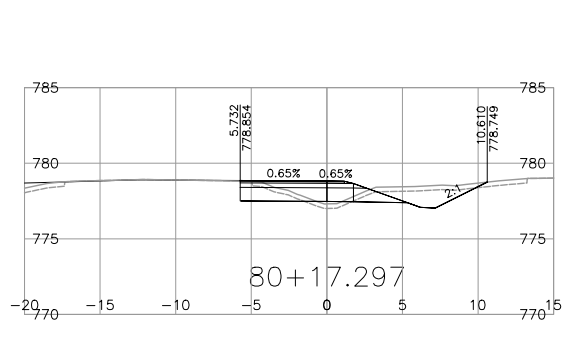
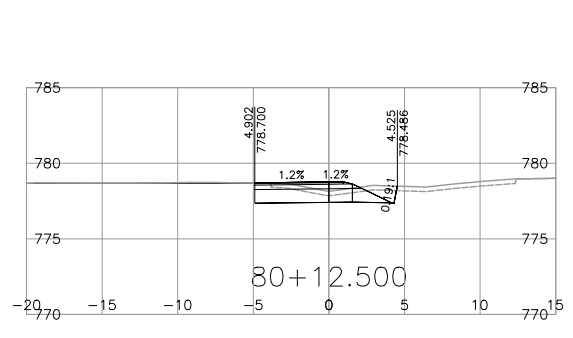
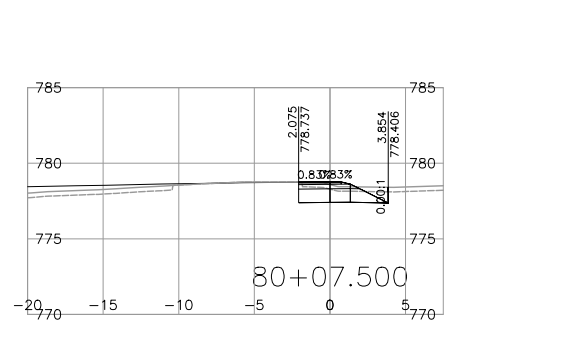
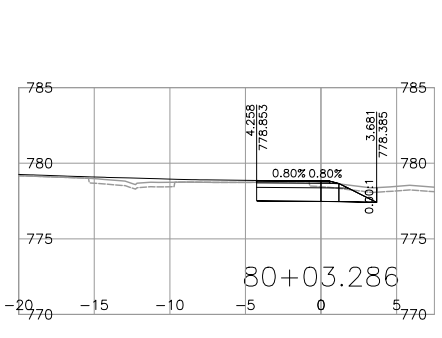
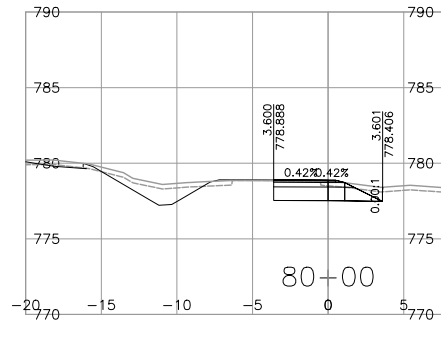
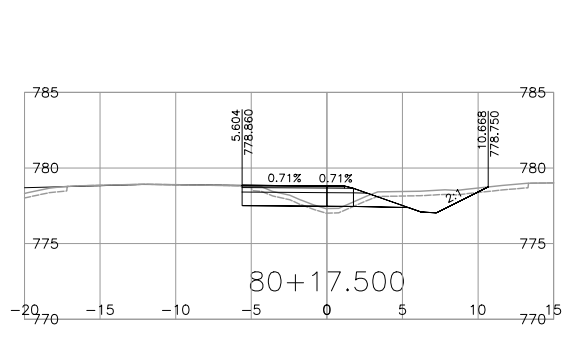
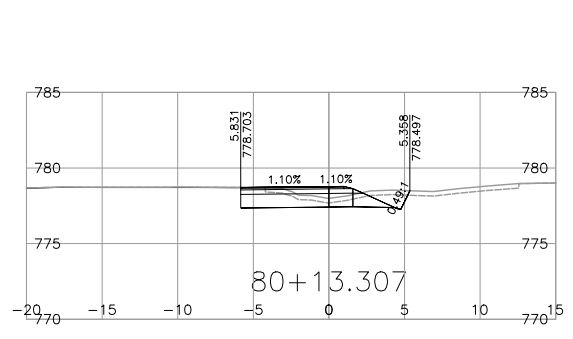
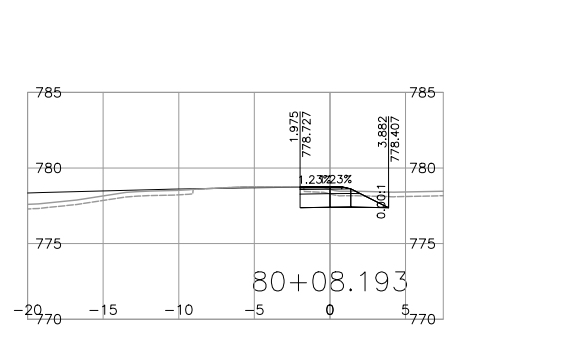
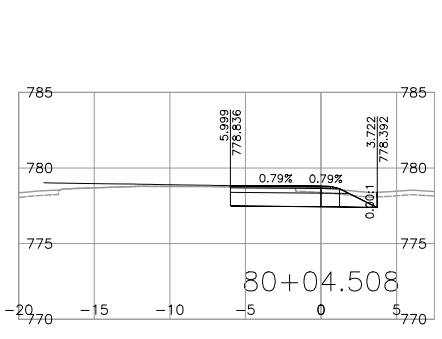
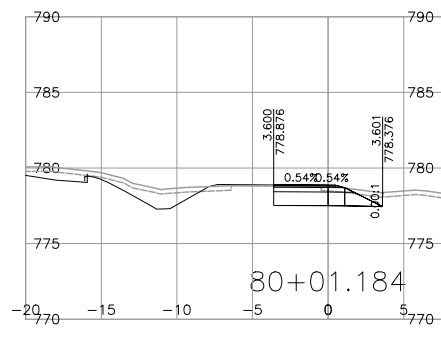
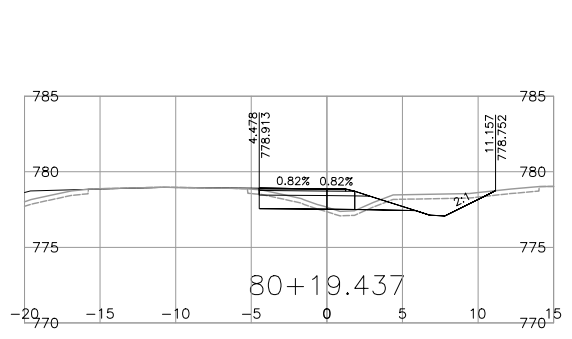
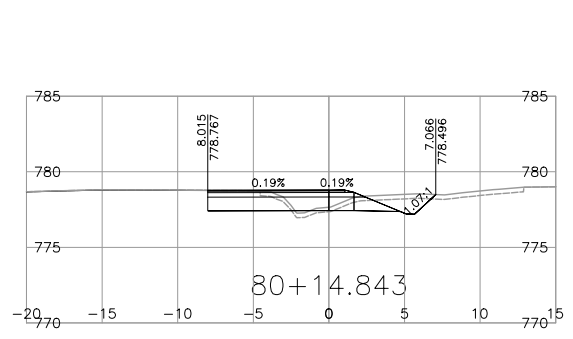
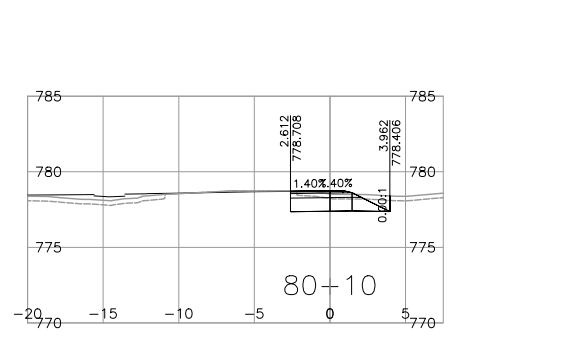
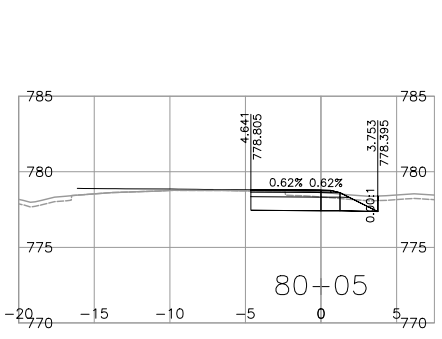
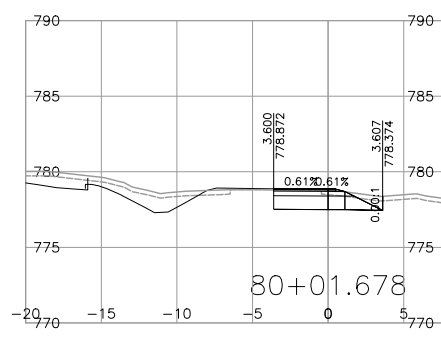
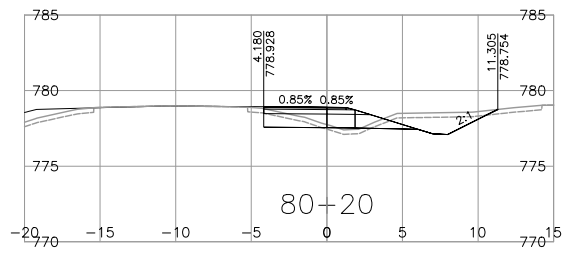
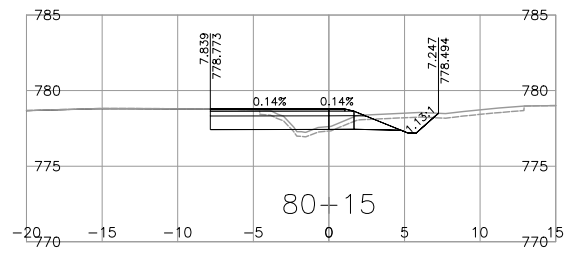
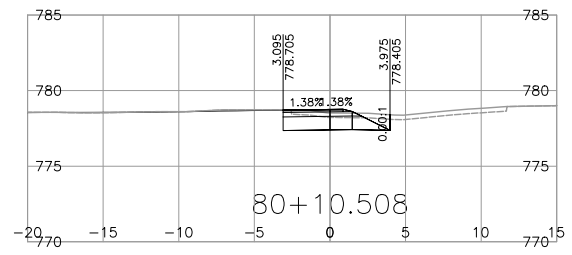
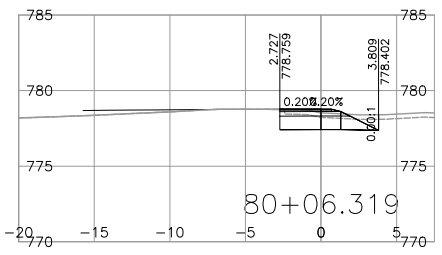
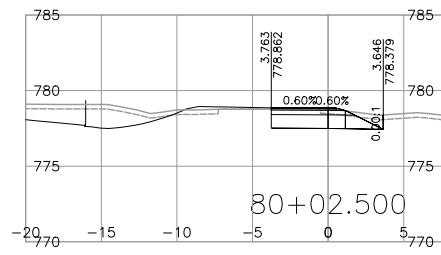

NOTE: STRIPPING REMOVAL APPLIES ONLY TO THE AREA BETWEEN SLOPE STAKE LINES (TOES & TOP OF CUT) OF PROPOSED ROADWAY TEMPLATE

FOR REFERENCE ONLY

DRAFT

FOR INFORMATION ONLY MARCH 03, 2023

R.F. BINNIE & ASSOCIATES LTD.
101 - 1577 7th Avenue,
Prince George, BC V2L 3P5
TEL 250 561 7274
BINNIE.com

MINISTRY OF TRANSPORTATION AND INFRASTRUCTURE
NORTHERN REGION
HIGHWAY ENGINEERING AND GEOMATICS

SCALE CAD FILENAME 21-0125-1000XS-C80A1.DWG
DATE 2023-03-01
FILE NUMBER 21-0125-00

REV	DATE	REVISIONS	SIGNATURE

C80-LINE CROSS SECTIONS
HIGHWAY 16
GUEST ROAD AND SHALLOW BAY ROAD INTERSECTIONS

DESIGNED _____ R.M. DATE MAR. 2023
 QUALITY CONTROL _____ K.T. DATE MAR. 2023
 QUALITY ASSURANCE _____ R.M. DATE MAR. 2023
 DRAWN _____ J.D. DATE MAR. 2023

PROJECT NUMBER 38199-0000 REG 3 DRAWING NUMBER R3-375-C80-1XS REV _____
 ENGINEER OF RECORD R. Mankowske DATE 20230303

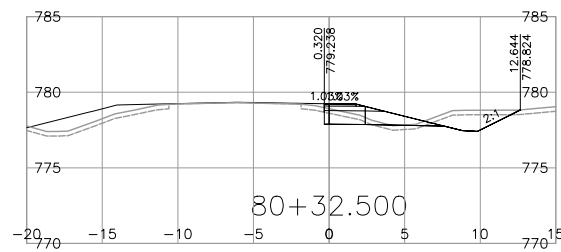
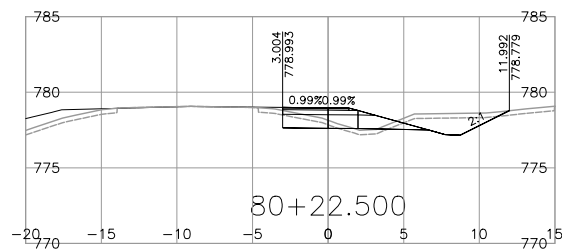
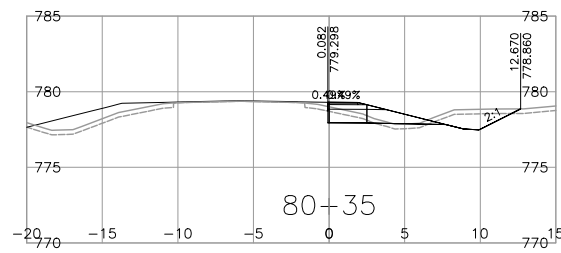
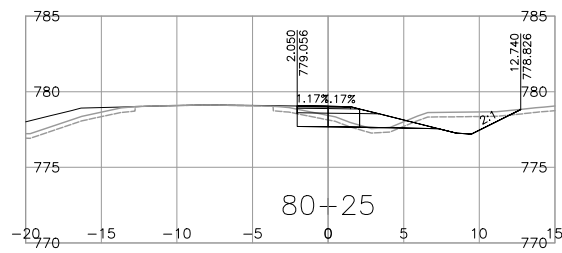
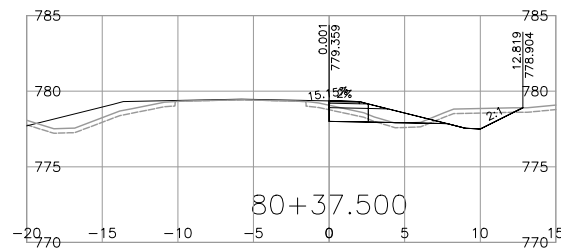
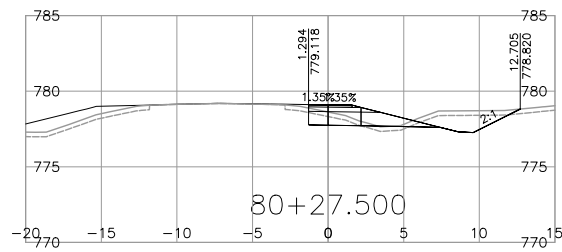
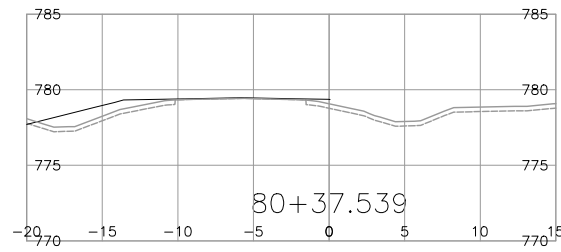
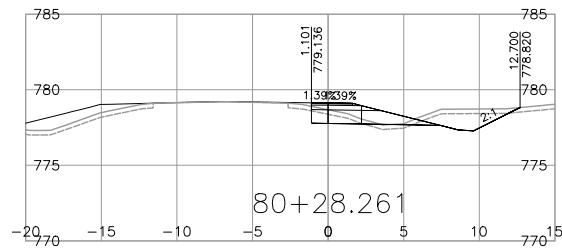
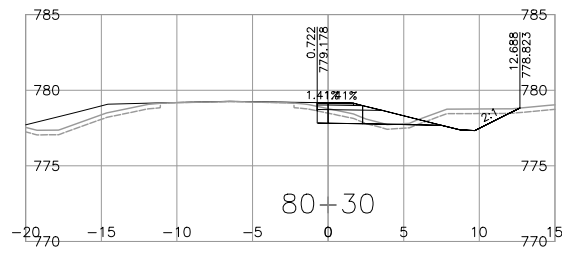

NOTE: STRIPPING REMOVAL APPLIES ONLY TO THE AREA BETWEEN SLOPE STAKE LINES (TOES & TOP OF CUT) OF PROPOSED ROADWAY TEMPLATE

FOR REFERENCE ONLY

DRAFT

FOR INFORMATION ONLY MARCH 03, 2023

<p>BINNIE The people behind your infrastructure.</p>	<p>R.F. BINNIE & ASSOCIATES LTD. 101 - 1577 7th Avenue, Prince George, BC V2L 3P5 TEL 250 561 7274 BINNIE.com</p>	<p>BRITISH COLUMBIA</p>	<p>MINISTRY OF TRANSPORTATION AND INFRASTRUCTURE NORTHERN REGION HIGHWAY ENGINEERING AND GEOMATICS</p>																																				
				<p>SCALE 0 2 1:250 12m</p> <p>CAD FILENAME 21-0125-1000XS-C80A1.DWG DATE 2023-03-01 FILE NUMBER 21-0125-00</p>																																			
<table border="1"> <thead> <tr> <th>REV</th> <th>DATE</th> <th>REVISIONS</th> <th>SIGNATURE</th> </tr> </thead> <tbody> <tr><td> </td><td> </td><td> </td><td> </td></tr> <tr><td> </td><td> </td><td> </td><td> </td></tr> <tr><td> </td><td> </td><td> </td><td> </td></tr> <tr><td> </td><td> </td><td> </td><td> </td></tr> <tr><td> </td><td> </td><td> </td><td> </td></tr> <tr><td> </td><td> </td><td> </td><td> </td></tr> <tr><td> </td><td> </td><td> </td><td> </td></tr> <tr><td> </td><td> </td><td> </td><td> </td></tr> </tbody> </table>		REV	DATE	REVISIONS	SIGNATURE																																	<p>C80-LINE CROSS SECTIONS HIGHWAY 16 GUEST ROAD AND SHALLOW BAY ROAD INTERSECTIONS</p>	
REV	DATE	REVISIONS	SIGNATURE																																				
<p>R. Mankowske ENGINEER OF RECORD DATE 20230303</p>		<table border="1"> <tr> <td>DESIGNED</td> <td>_____</td> <td>R.M.</td> <td>DATE</td> <td>MAR_2023</td> </tr> <tr> <td>QUALITY CONTROL</td> <td>_____</td> <td>K.T.</td> <td>DATE</td> <td>MAR_2023</td> </tr> <tr> <td>QUALITY ASSURANCE</td> <td>_____</td> <td>R.M.</td> <td>DATE</td> <td>MAR_2023</td> </tr> <tr> <td>DRAWN</td> <td>_____</td> <td>J.D.</td> <td>DATE</td> <td>MAR_2023</td> </tr> <tr> <td>PROJECT NUMBER</td> <td>38199-0000</td> <td>REG</td> <td>3</td> <td>DRAWING NUMBER</td> </tr> <tr> <td colspan="2"></td> <td colspan="2"></td> <td>R3-375-C80-2XS</td> </tr> </table>		DESIGNED	_____	R.M.	DATE	MAR_2023	QUALITY CONTROL	_____	K.T.	DATE	MAR_2023	QUALITY ASSURANCE	_____	R.M.	DATE	MAR_2023	DRAWN	_____	J.D.	DATE	MAR_2023	PROJECT NUMBER	38199-0000	REG	3	DRAWING NUMBER					R3-375-C80-2XS						
DESIGNED	_____	R.M.	DATE	MAR_2023																																			
QUALITY CONTROL	_____	K.T.	DATE	MAR_2023																																			
QUALITY ASSURANCE	_____	R.M.	DATE	MAR_2023																																			
DRAWN	_____	J.D.	DATE	MAR_2023																																			
PROJECT NUMBER	38199-0000	REG	3	DRAWING NUMBER																																			
				R3-375-C80-2XS																																			

Mar. 1, 2023 - 10:57 AM P:\2021\21-0125-00 - CAD Files\CAD\H1\CrossSection\H1\DrawingProduction\000_Design\Sections\H1_0125-1000XS-C80A1

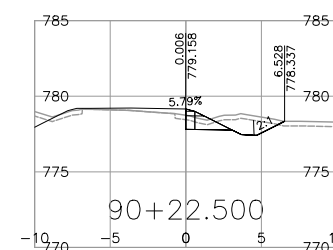
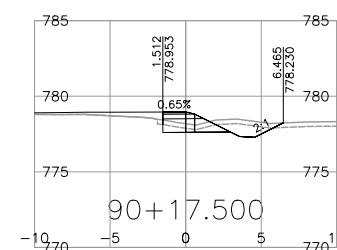
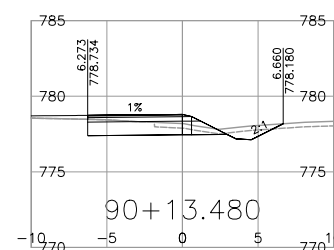
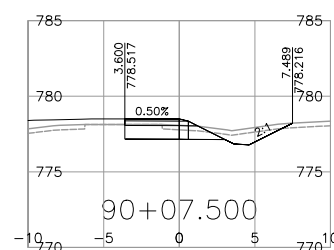
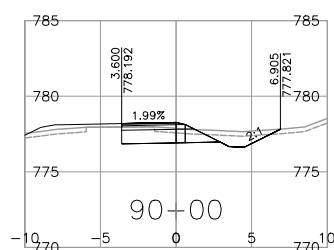
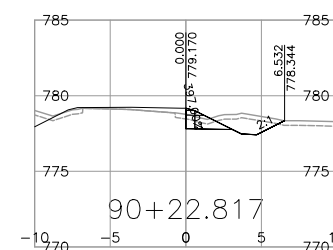
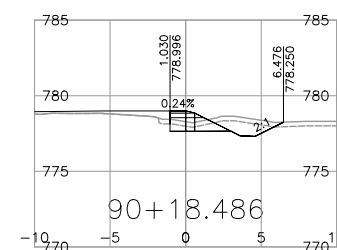
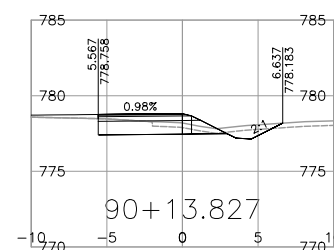
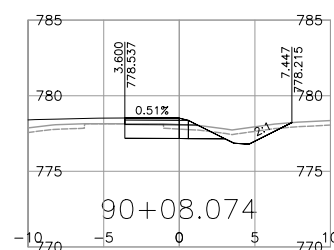
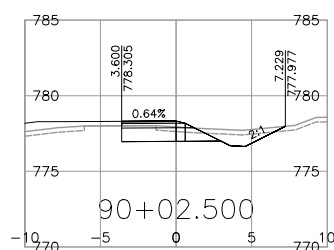
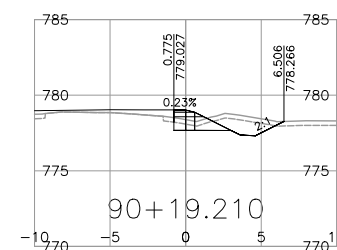
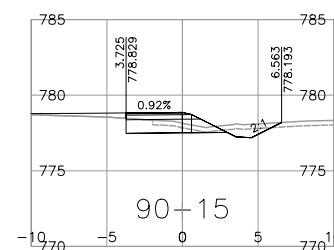
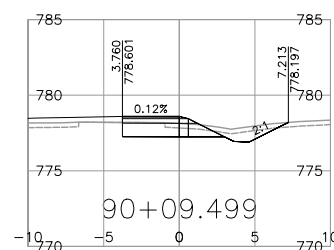
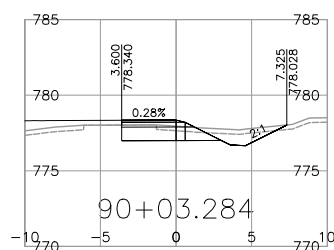
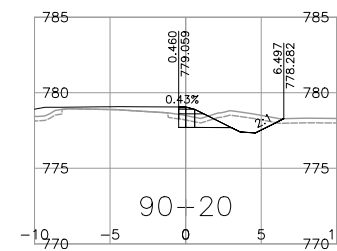
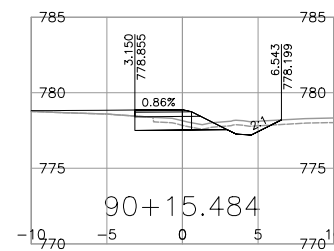
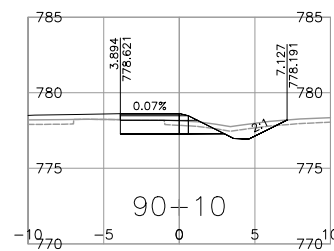
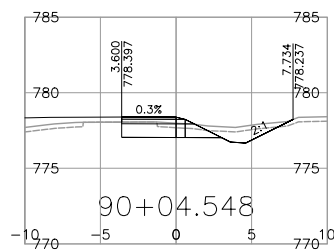
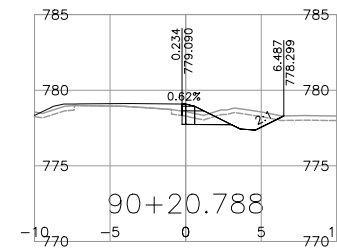
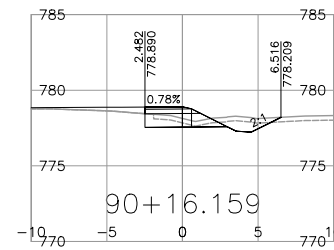
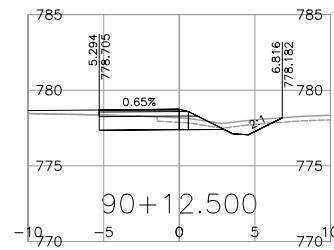
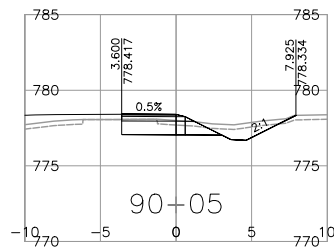

NOTE: STRIPPING REMOVAL APPLIES ONLY TO THE AREA BETWEEN SLOPE STAKE LINES (TOES & TOP OF CUT) OF PROPOSED ROADWAY TEMPLATE

FOR REFERENCE ONLY

DRAFT

FOR INFORMATION ONLY MARCH 03, 2023

BINNIE
The people behind your infrastructure.

R.F. BINNIE & ASSOCIATES LTD.
101 - 1577 7th Avenue,
Prince George, BC V2L 3P5
TEL 250 561 7274
BINNIE.com

CAD FILENAME: 21-0125-1000XS-C90A1.DWG
DATE: 2023-03-01
FILE NUMBER: 21-0125-00

SCALE: 0 2 1:250 12m

REV	DATE	REVISIONS	SIGNATURE

BRITISH COLUMBIA
MINISTRY OF TRANSPORTATION AND INFRASTRUCTURE
NORTHERN REGION
HIGHWAY ENGINEERING AND GEOMATICS

C90-LINE CROSS SECTIONS
HIGHWAY 16
GUEST ROAD AND SHALLOW BAY ROAD INTERSECTIONS

DESIGNED	_____	R.M.	DATE	MAR, 2023
QUALITY CONTROL	_____	K.T.	DATE	MAR, 2023
QUALITY ASSURANCE	_____	R.M.	DATE	MAR, 2023
DRAWN	_____	J.D.	DATE	MAR, 2023

R. Mankowske
ENGINEER OF RECORD
DATE: 20230303

PROJECT NUMBER	38199-0000	REG	3	DRAWING NUMBER	R3-375-C90-1XS	REV	
----------------	------------	-----	---	----------------	----------------	-----	--

Mar. 1, 2023 - 11:00 AM P:\2021\21-0125-00 - CAD Files\CSD\H1\CUsers\RF1\Drawings\Production\1000_Design\Sections\21-0125-1000XS-C90A1

Mar. 1, 2023 - 11:00 AM P:\2021\21-0125-00 - CAD Files\CSD\H1\CUsers\FH1\Drawings\Production\000_Design\Sections\1-0125-1000XS-C110A1

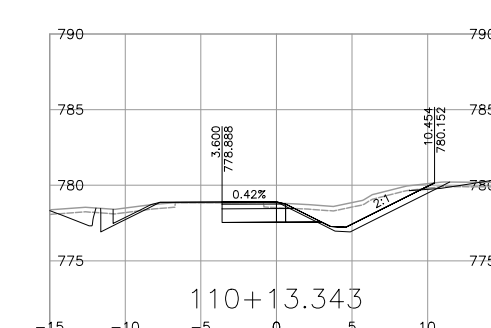
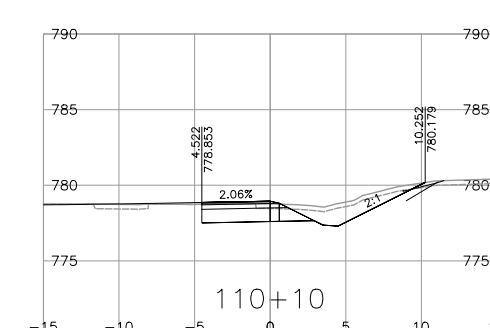
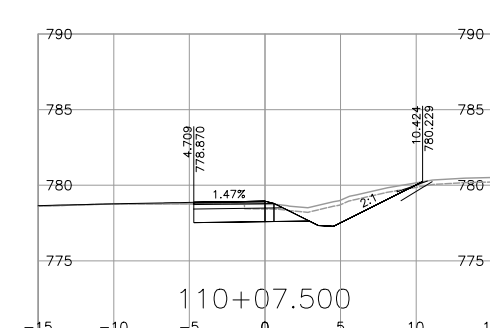
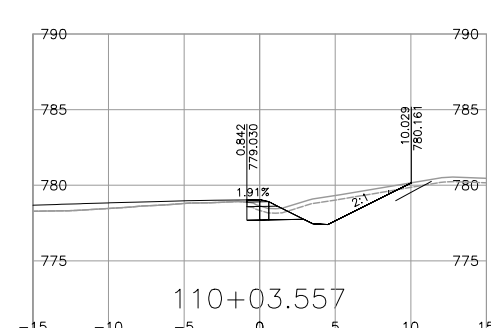
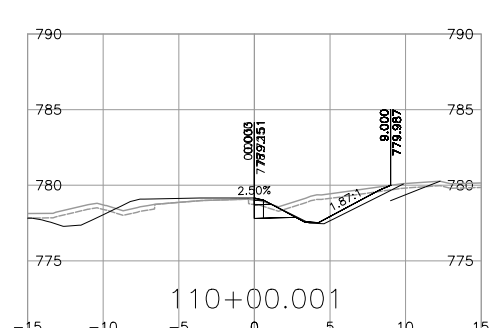
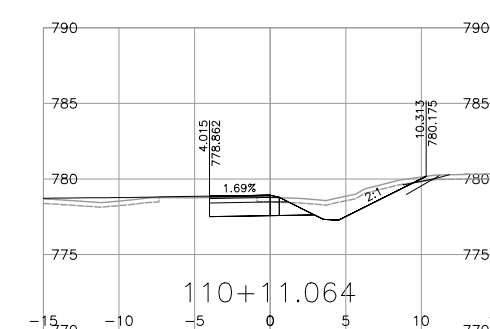
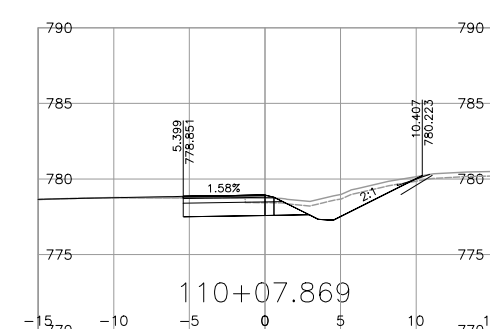
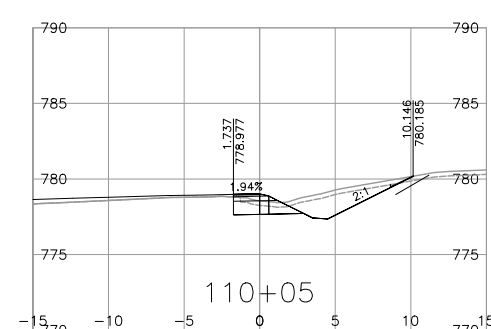
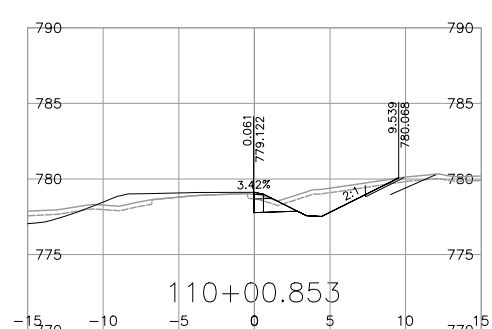
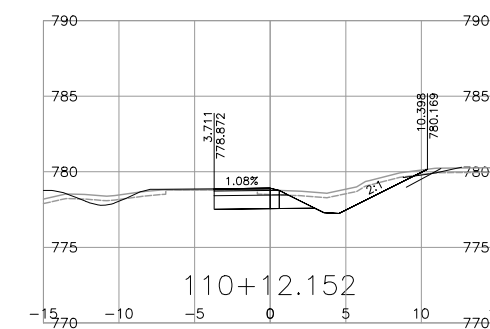
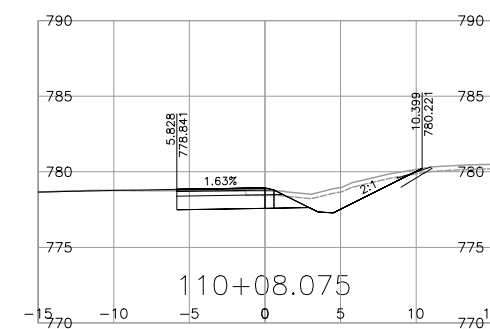
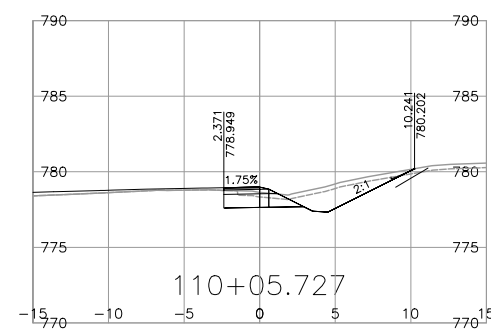
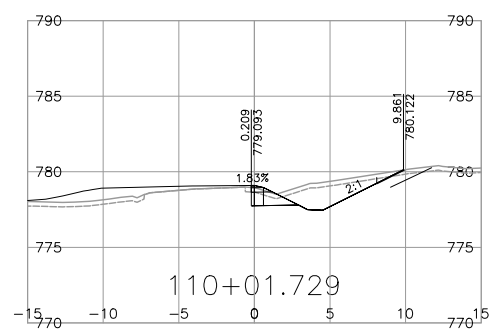
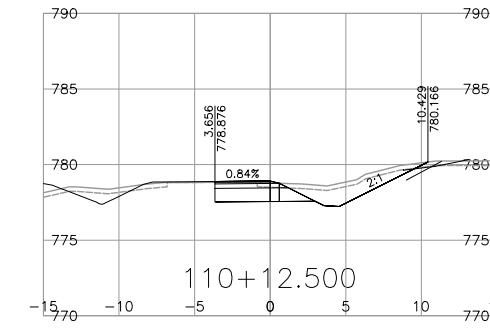
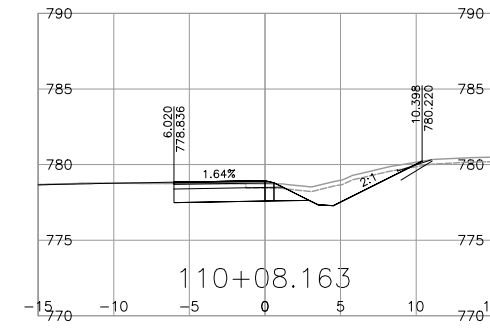
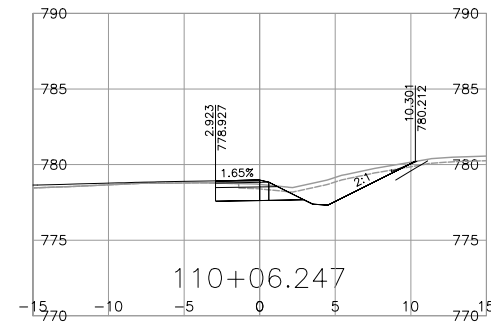
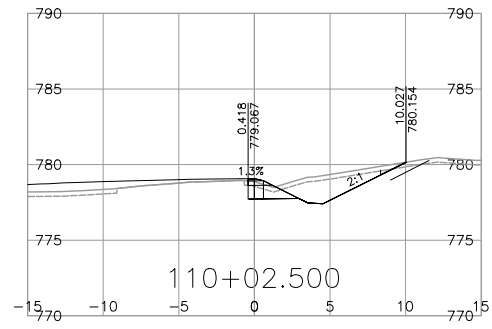

NOTE: STRIPPING REMOVAL APPLIES ONLY TO THE AREA BETWEEN SLOPE STAKE LINES (TOES & TOP OF CUT) OF PROPOSED ROADWAY TEMPLATE

FOR REFERENCE ONLY

DRAFT

FOR INFORMATION ONLY MARCH 03, 2023

BINNIE
The people behind your infrastructure.

R.F. BINNIE & ASSOCIATES LTD.
101 - 1577 7th Avenue,
Prince George, BC V2L 3P5
TEL 250 561 7274
BINNIE.com

BRITISH COLUMBIA

MINISTRY OF TRANSPORTATION AND INFRASTRUCTURE
NORTHERN REGION
HIGHWAY ENGINEERING AND GEOMATICS

SCALE 0 2 1:250 12m

CAD FILENAME 21-0125-1000XS-C110A1.DWG
DATE 2023-03-01
FILE NUMBER 21-0125-00

REV	DATE	REVISIONS	SIGNATURE

C110-LINE CROSS SECTIONS
HIGHWAY 16
GUEST ROAD AND SHALLOW BAY ROAD INTERSECTIONS

DESIGNED	_____	R.M.	DATE	MAR. 2023
QUALITY CONTROL	_____	K.T.	DATE	MAR. 2023
QUALITY ASSURANCE	_____	R.M.	DATE	MAR. 2023
DRAWN	_____	J.D.	DATE	MAR. 2023

R. Mankowske
ENGINEER OF RECORD
DATE 20230303

PROJECT NUMBER	38199-0000	REG	3	DRAWING NUMBER	R3-375-C110-1XS	REV	
----------------	------------	-----	---	----------------	-----------------	-----	--

Mar. 1, 2023 - 11:17 AM P:\2021\21-0125-00 - CAD Files\CAD-Files\H1\DrawingProduction\000_DisposalSite1\0125-1000XS-DISPOSAL

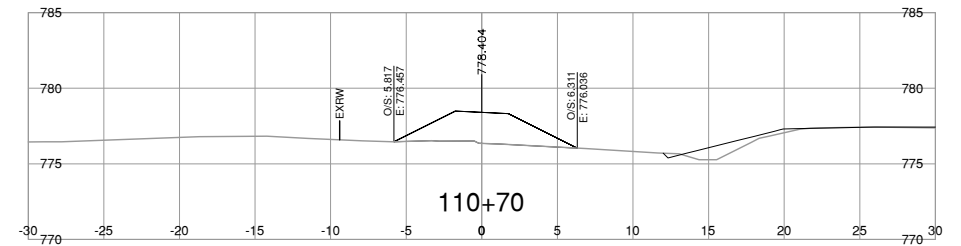
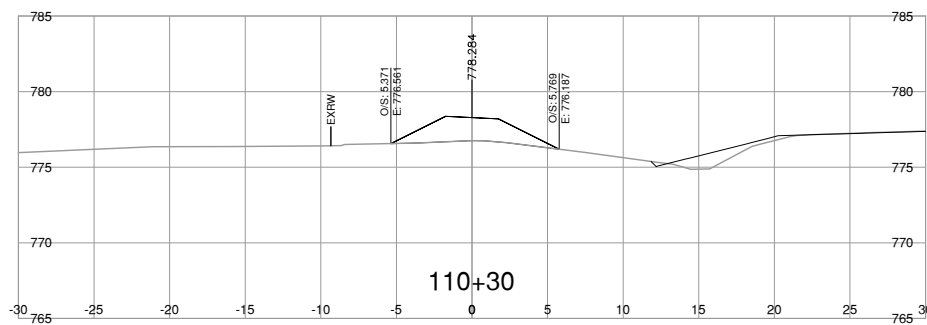
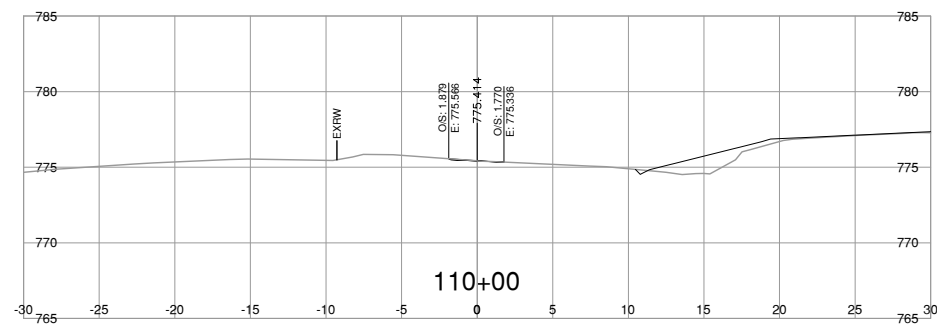
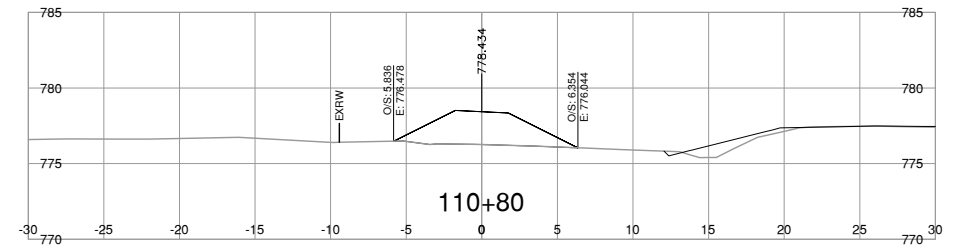
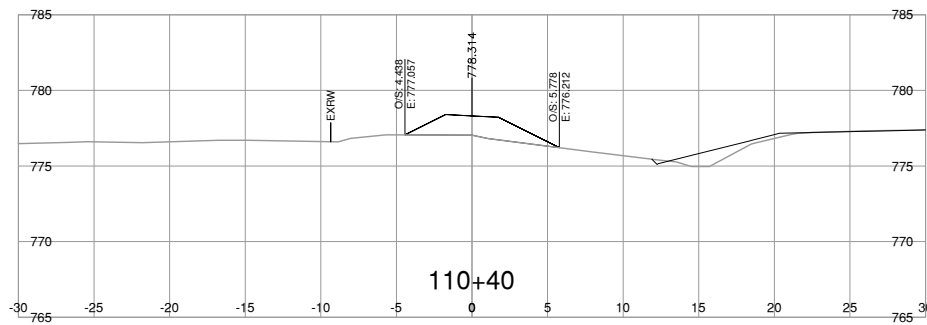
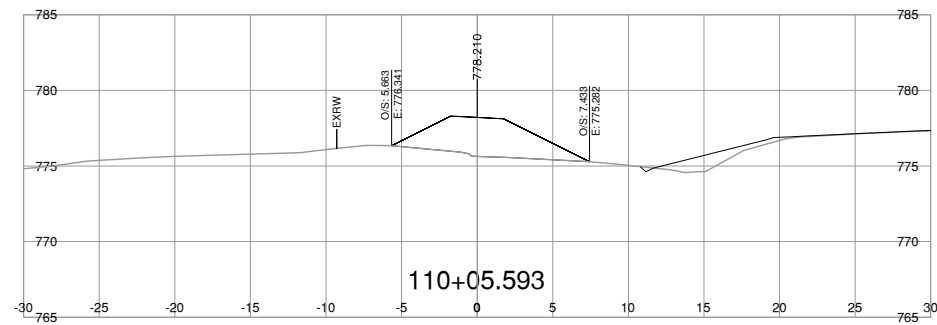
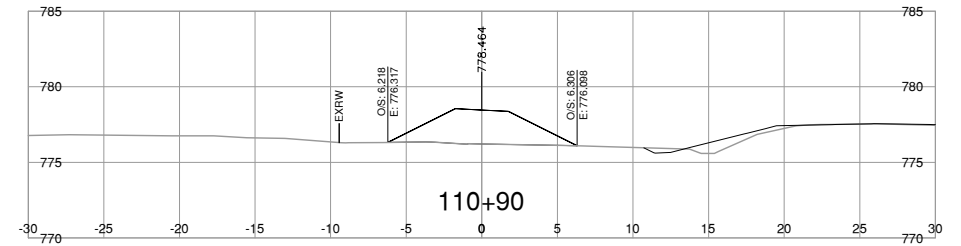
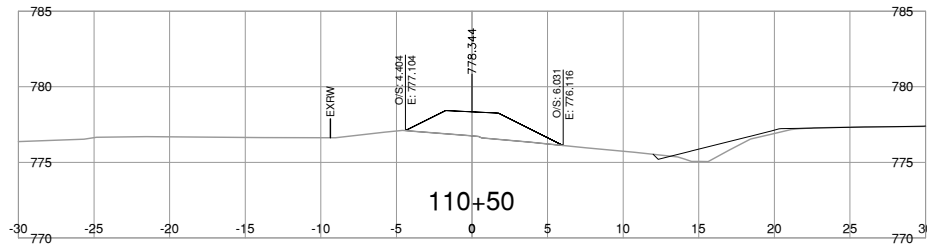
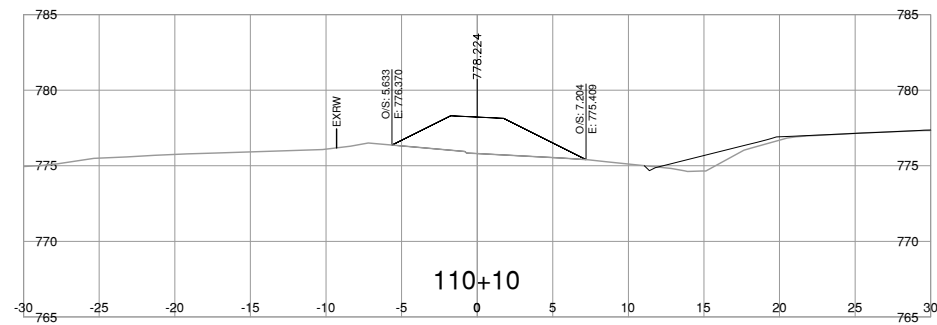
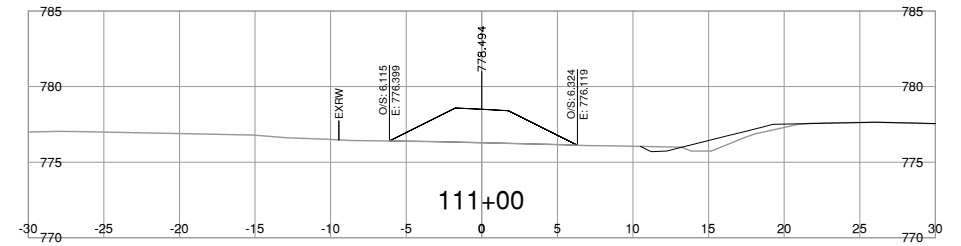
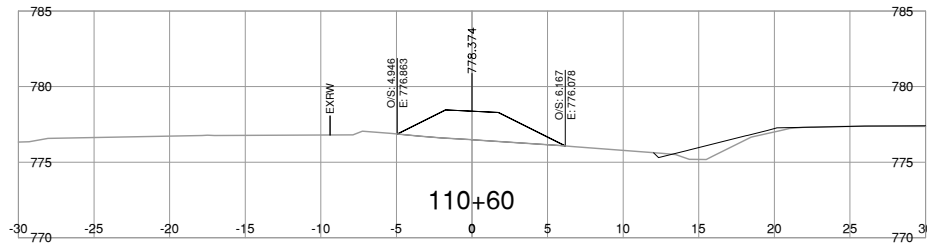
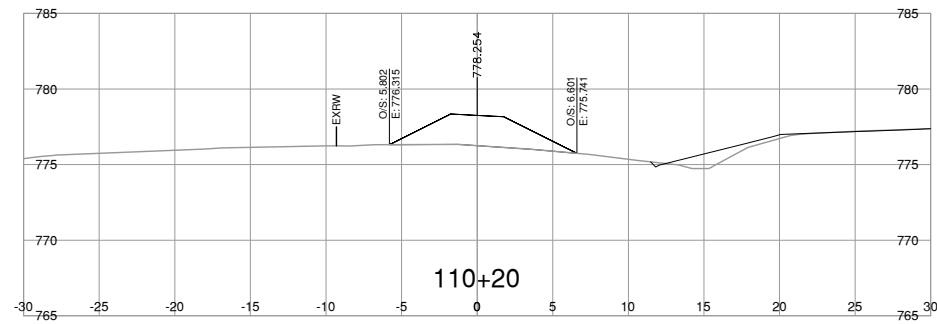

NOTE: STRIPPING REMOVAL APPLIES ONLY TO THE AREA BETWEEN SLOPE STAKE LINES (TOES & TOP OF CUT) OF PROPOSED ROADWAY TEMPLATE

FOR REFERENCE ONLY

DRAFT

FOR INFORMATION ONLY MARCH 03, 2023

BINNIE
The people behind your infrastructure.

R.F. BINNIE & ASSOCIATES LTD.
101 - 1577 7th Avenue,
Prince George, BC V2L 3P5
TEL 250 561 7274
BINNIE.com

BRITISH COLUMBIA
MINISTRY OF TRANSPORTATION AND INFRASTRUCTURE
NORTHERN REGION
HIGHWAY ENGINEERING AND GEOMATICS

DISPOSAL SITE 1 CROSS SECTIONS
HIGHWAY 16
GUEST ROAD AND SHALLOW BAY ROAD INTERSECTIONS

SCALE: 0 2 1:250 12m

CAD FILENAME: 21-0125-1000XS-DISPOSAL_DWG
DATE: 2023-03-01
FILE NUMBER: 21-0125-00

REV	DATE	REVISIONS	SIGNATURE

DESIGNED: _____	J.D.	DATE: MAR. 2023
QUALITY CONTROL: _____	R.M.	DATE: MAR. 2023
QUALITY ASSURANCE: _____	M.C.	DATE: MAR. 2023
DRAWN: _____	J.D.	DATE: MAR. 2023

R. Mankowske
ENGINEER OF RECORD
DATE: 20230303

PROJECT NUMBER	REG	DRAWING NUMBER	REV
38199-0000	3	110W1-1XS	

Mar. 1, 2023 - 11:17 AM P:\2021\21-0125-00 - CAD Files\CAD\Drawings\Production\000_DisposalSite1\Drawings\Production\000_DisposalSite1.dwg

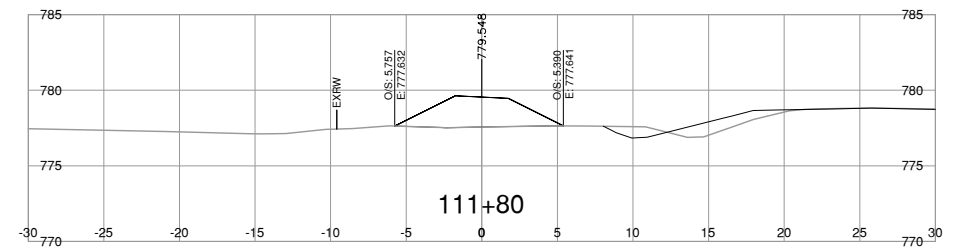
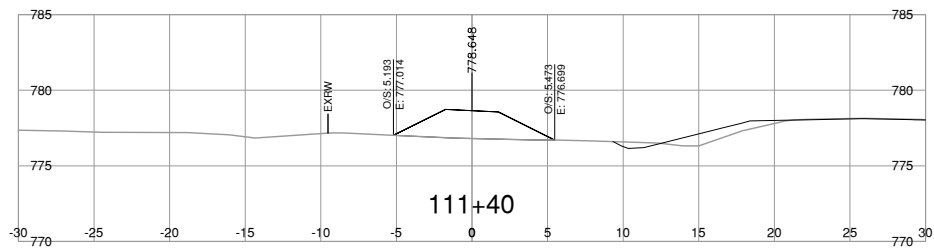
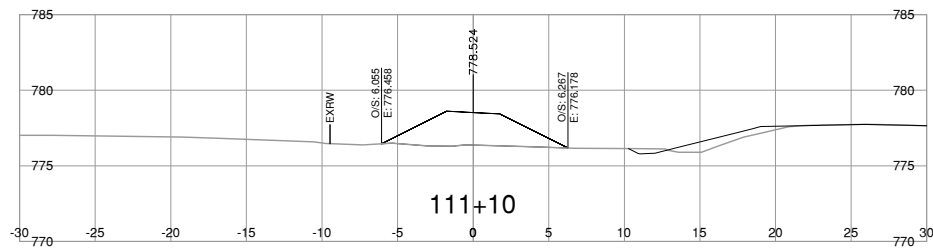
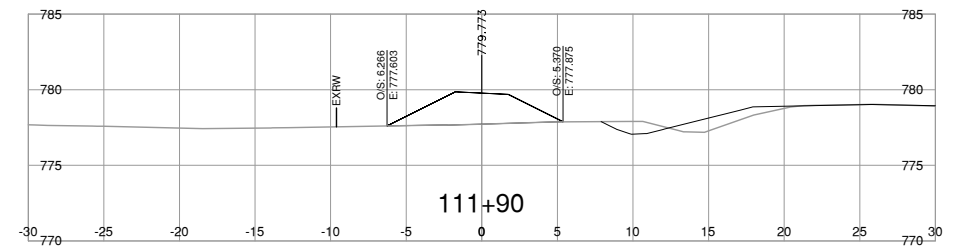
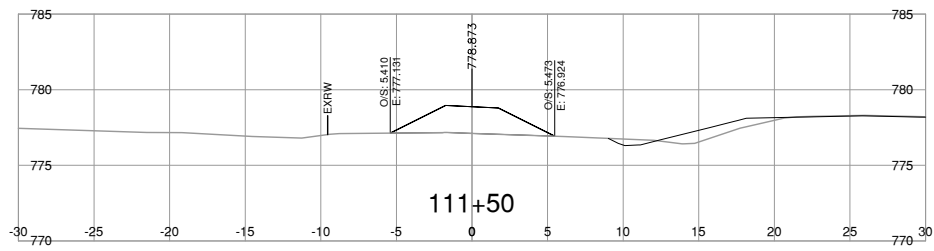
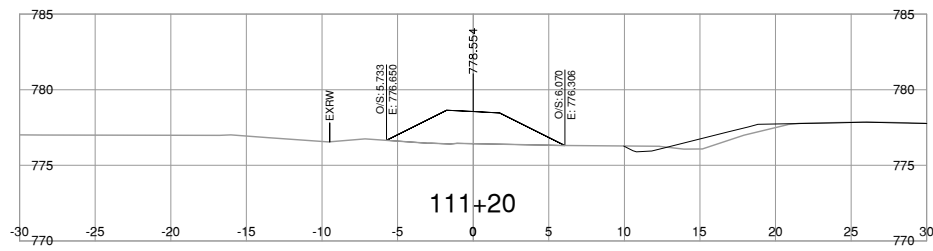
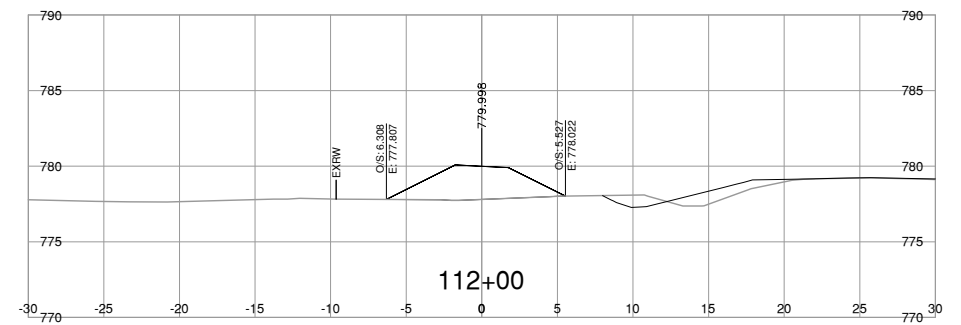
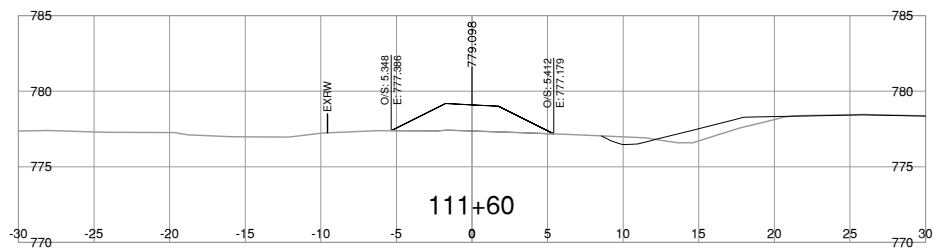
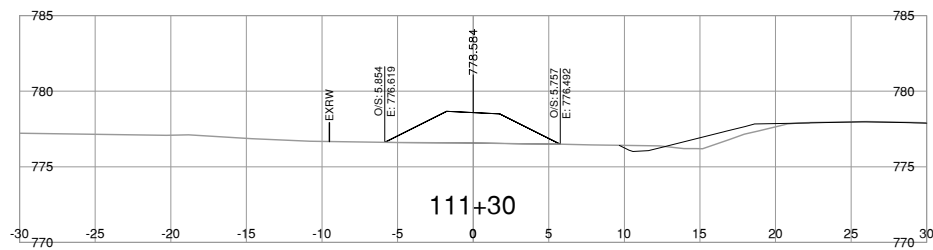
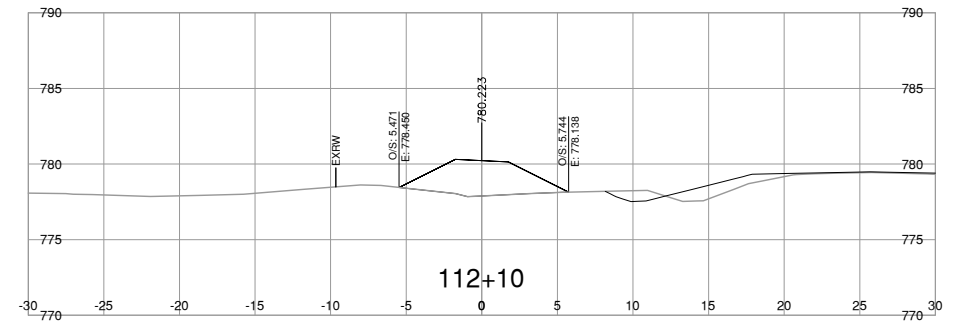
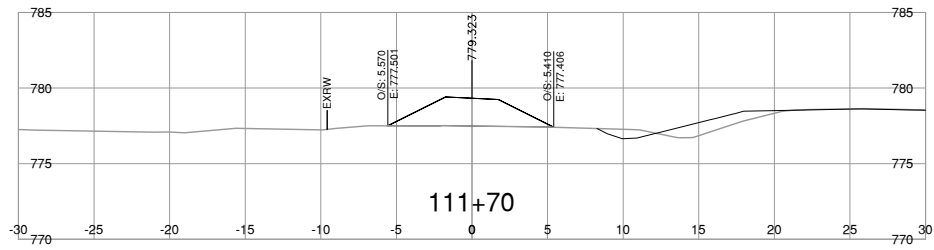
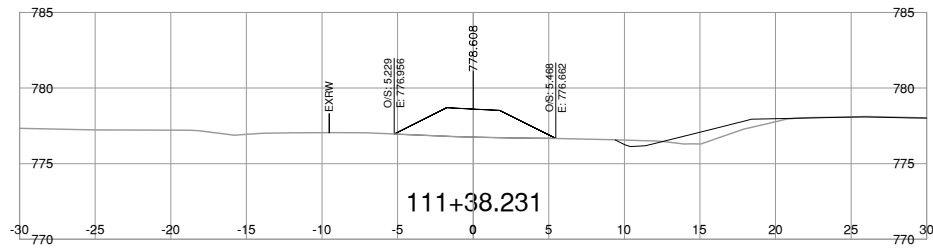

NOTE: STRIPPING REMOVAL APPLIES ONLY TO THE AREA BETWEEN SLOPE STAKE LINES (TOES & TOP OF CUT) OF PROPOSED ROADWAY TEMPLATE

FOR REFERENCE ONLY

DRAFT

FOR INFORMATION ONLY MARCH 03, 2023

R.F. BINNIE & ASSOCIATES LTD.
101 - 1577 7th Avenue,
Prince George, BC V2L 3P5
TEL 250 561 7274
BINNIE.com

BRITISH COLUMBIA

MINISTRY OF TRANSPORTATION AND INFRASTRUCTURE
NORTHERN REGION
HIGHWAY ENGINEERING AND GEOMATICS

DISPOSAL SITE 1 CROSS SECTIONS
HIGHWAY 16
GUEST ROAD AND SHALLOW BAY ROAD INTERSECTIONS

SCALE: 0 2 1:250 12m

CAD FILENAME: 21-0125-1000XS-DISPOSAL_DWG
DATE: 2023-03-01
FILE NUMBER: 21-0125-00

REV	DATE	REVISIONS	SIGNATURE

DESIGNED	J.D.	DATE	MAR. 2023
QUALITY CONTROL	R.M.	DATE	MAR. 2023
QUALITY ASSURANCE	M.C.	DATE	MAR. 2023
DRAWN	J.D.	DATE	MAR. 2023

PROJECT NUMBER	REG	DRAWING NUMBER	REV
38199-0000	3	110W1-2XS	

R. Mankowske
ENGINEER OF RECORD
DATE 20230303

Mar. 1, 2023 - 11:17 AM P:\2021\21-0125-00 - CAD Files\CAD\H1\Drawings\Production\000_DisposalSite1\000XS-DISPOSAL

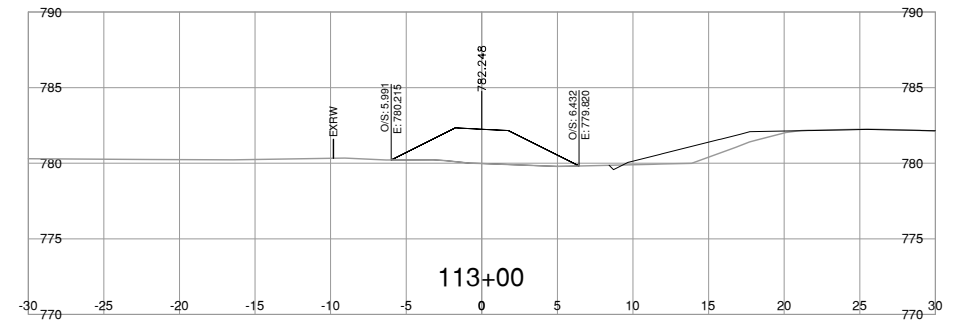
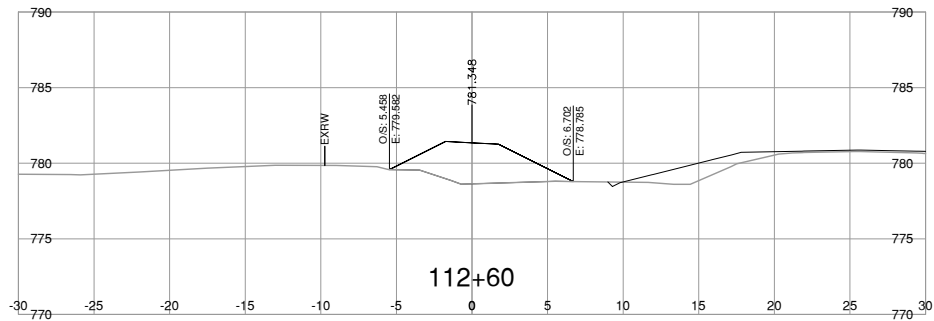
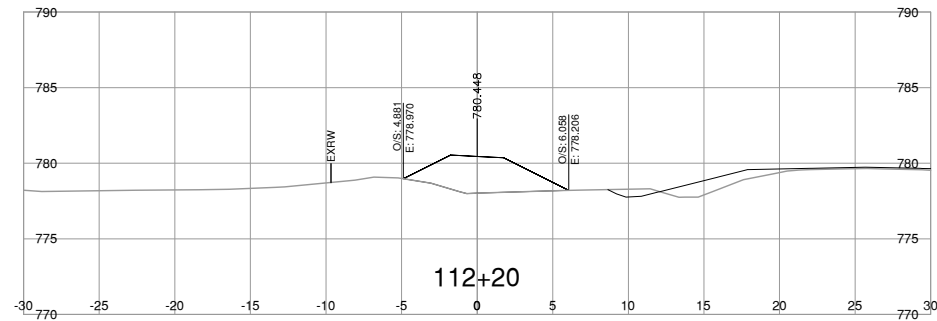
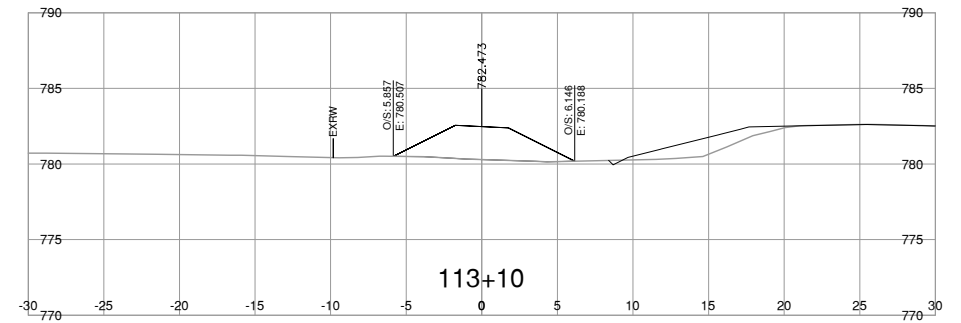
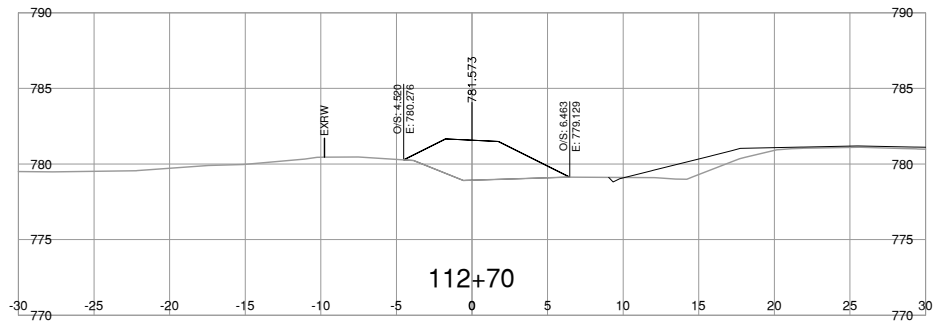
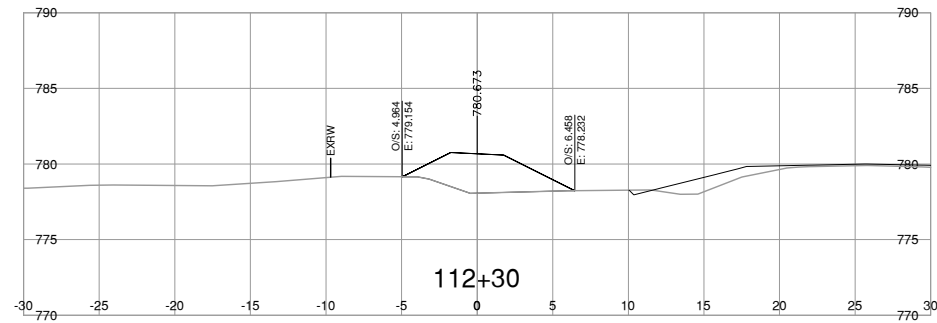
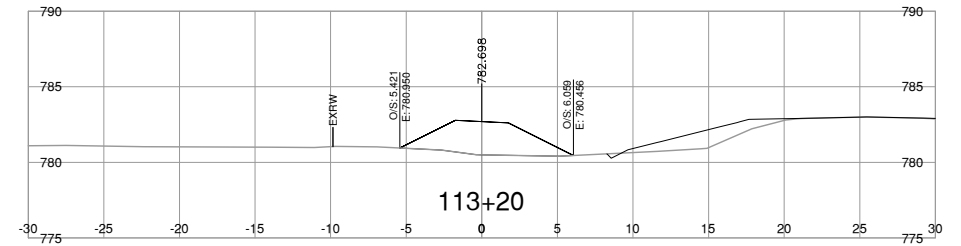
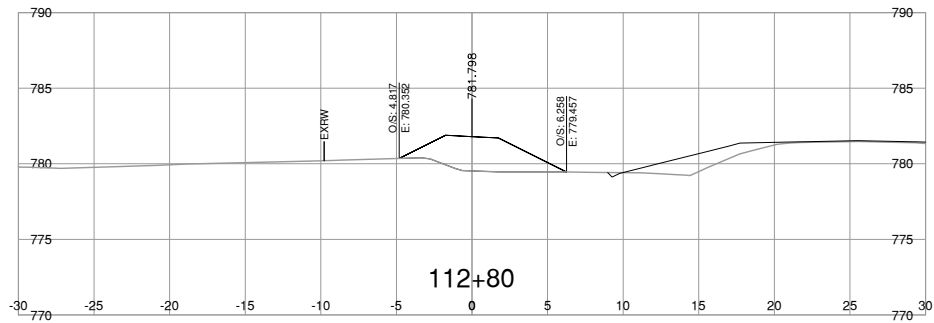
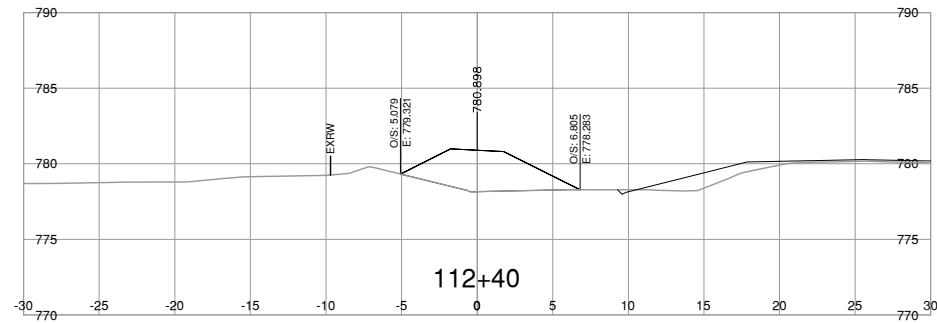
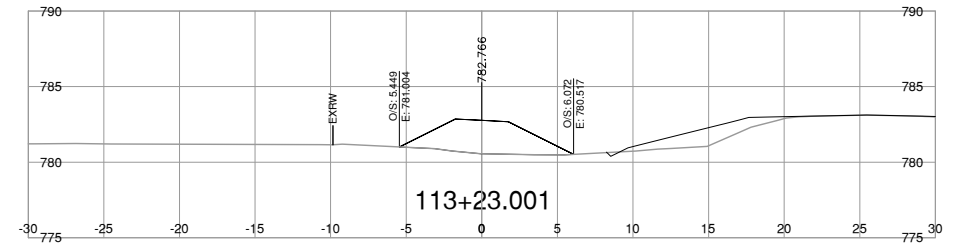
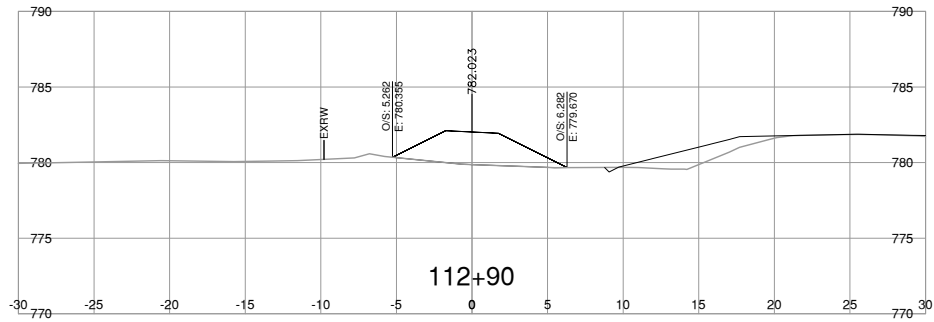
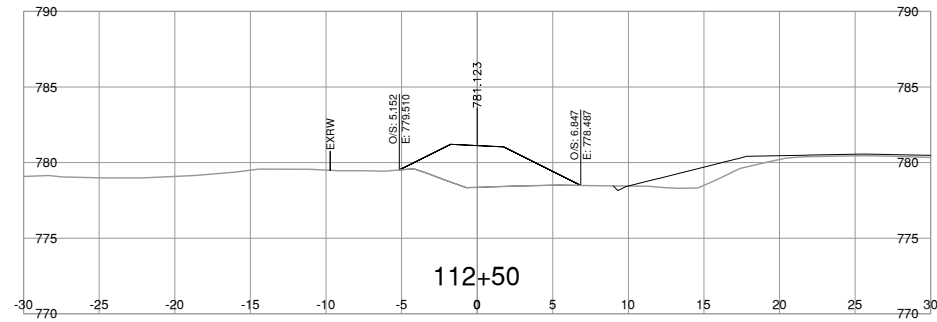

NOTE: STRIPPING REMOVAL APPLIES ONLY TO THE AREA BETWEEN SLOPE STAKE LINES (TOES & TOP OF CUT) OF PROPOSED ROADWAY TEMPLATE

FOR REFERENCE ONLY

DRAFT

FOR INFORMATION ONLY MARCH 03, 2023

BINNIE
The people behind your infrastructure.

R.F. BINNIE & ASSOCIATES LTD.
101 - 1577 7th Avenue,
Prince George, BC V2L 3P5
TEL 250 561 7274
BINNIE.com

BRITISH COLUMBIA

MINISTRY OF TRANSPORTATION AND INFRASTRUCTURE
NORTHERN REGION
HIGHWAY ENGINEERING AND GEOMATICS

DISPOSAL SITE 1 CROSS SECTIONS
HIGHWAY 16
GUEST ROAD AND SHALLOW BAY ROAD INTERSECTIONS

SCALE: 0 2 1:250 12m

CAD FILENAME: 21-0125-1000XS-DISPOSAL_DWG
DATE: 2023-03-01
FILE NUMBER: 21-0125-00

REV	DATE	REVISIONS	SIGNATURE

DESIGNED	J.D.	DATE	MAR. 2023
QUALITY CONTROL	R.M.	DATE	MAR. 2023
QUALITY ASSURANCE	M.C.	DATE	MAR. 2023
DRAWN	J.D.	DATE	MAR. 2023

R. Mankowske
ENGINEER OF RECORD
DATE 20230303

PROJECT NUMBER	REG	DRAWING NUMBER	REV
38199-0000	3	110W1-3XS	

Mar. 1, 2023 - 11:17 AM P:\2021\21-0125-00 - CAD Files\CAD\H1\Drawings\Production\000_DisposalSite1\000XS.DWG

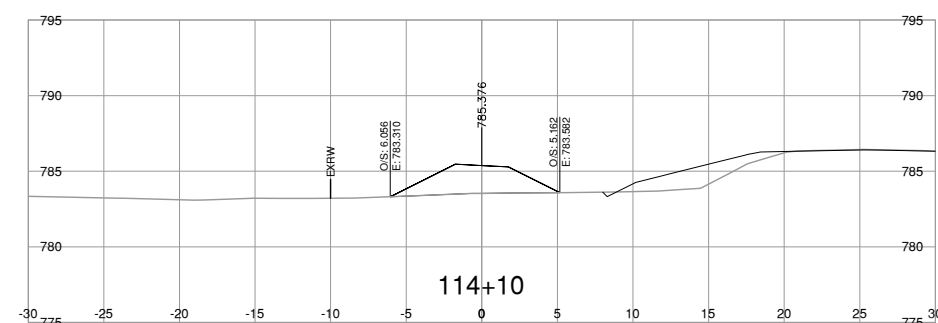
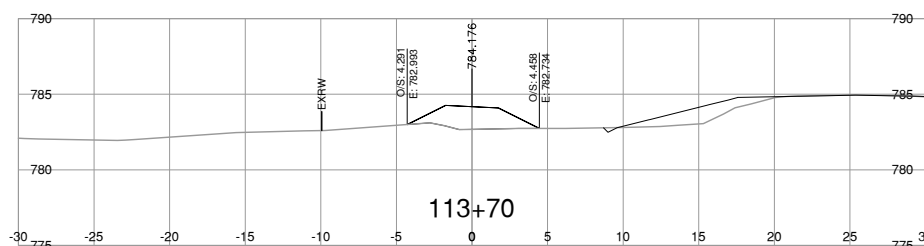
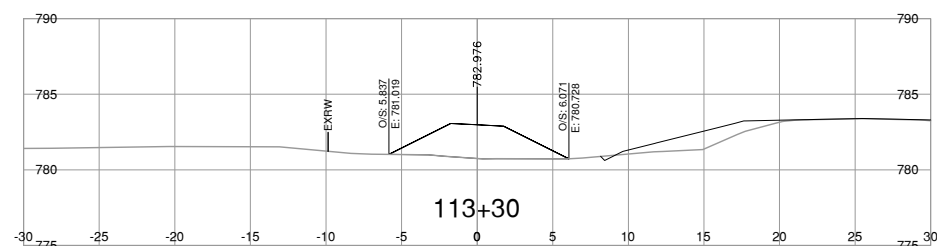
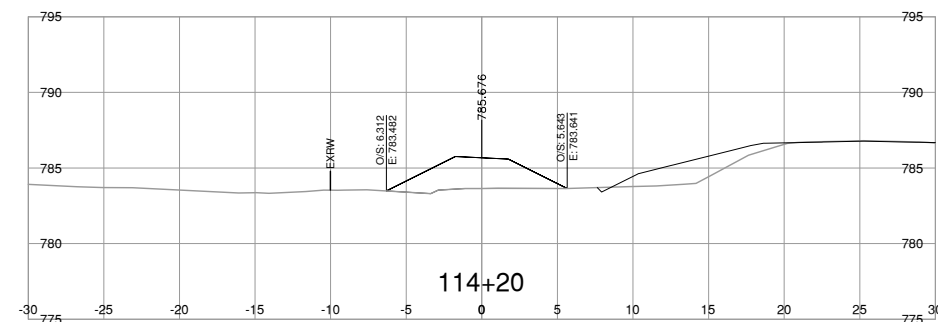
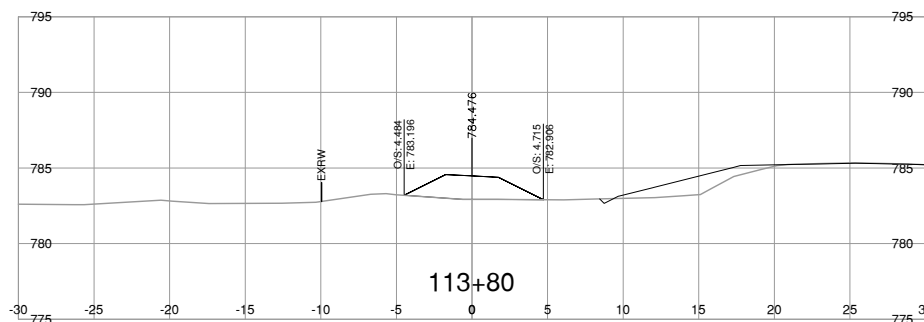
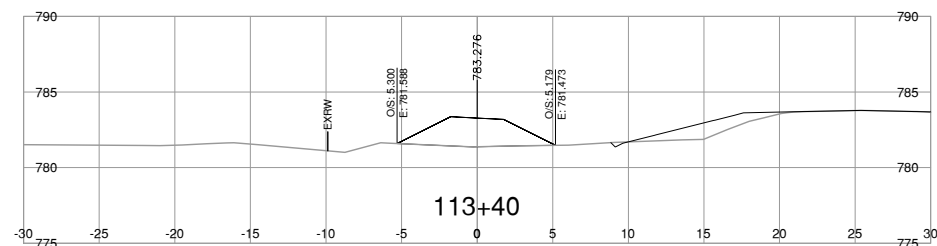
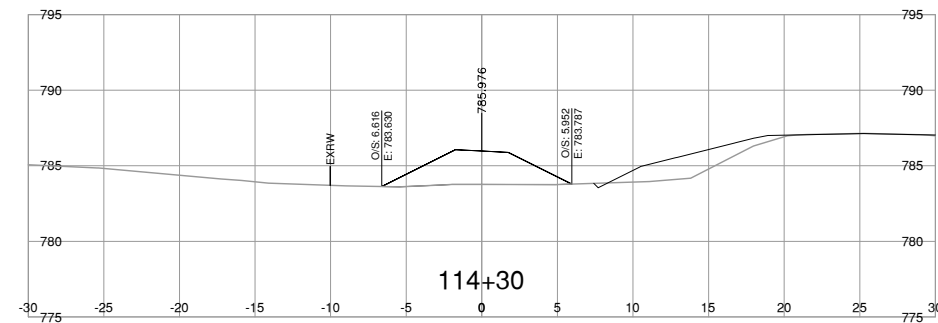
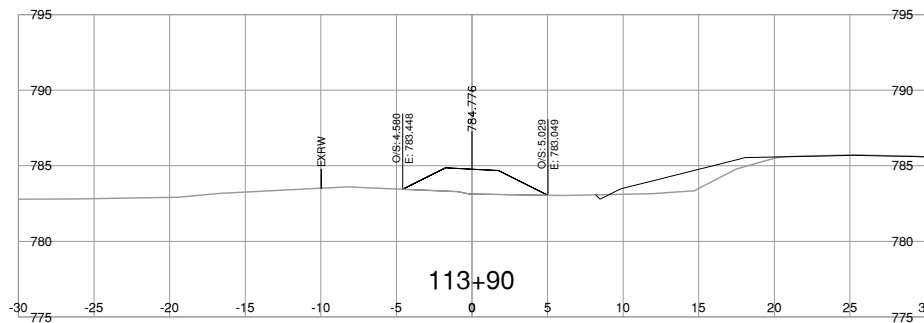
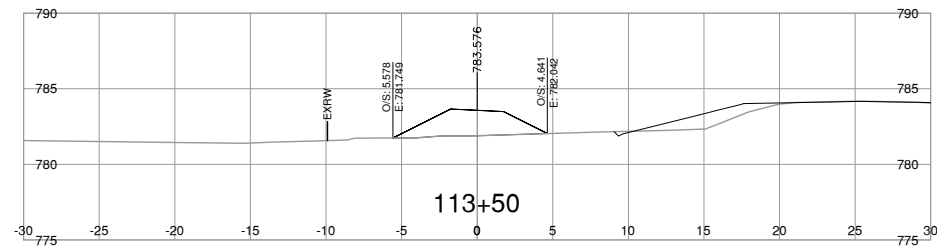
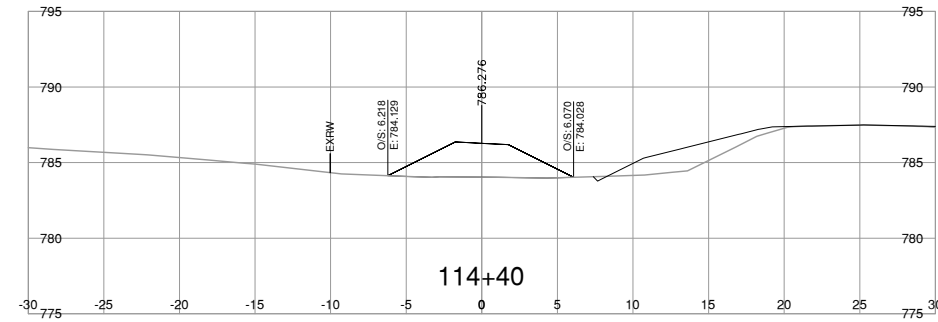
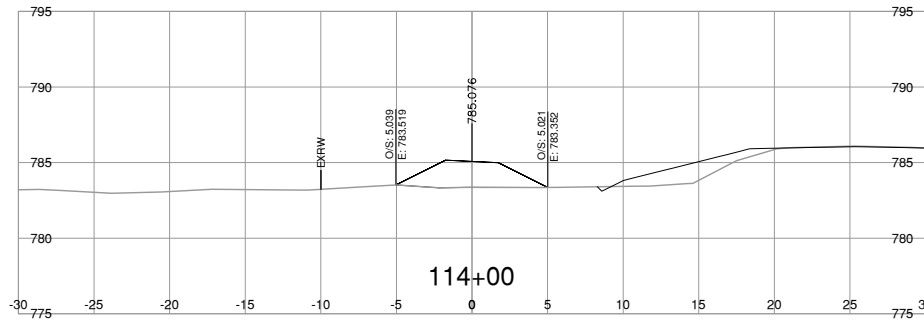
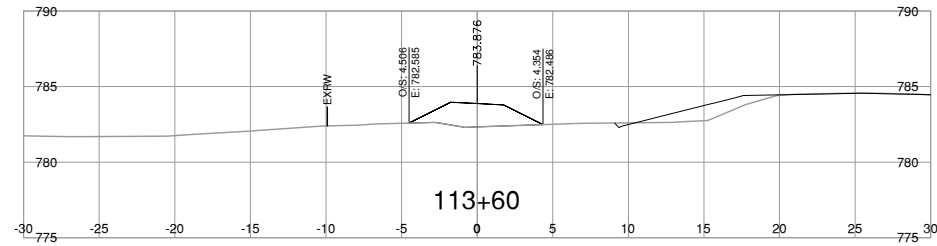

NOTE: STRIPPING REMOVAL APPLIES ONLY TO THE AREA BETWEEN SLOPE STAKE LINES (TOES & TOP OF CUT) OF PROPOSED ROADWAY TEMPLATE

FOR REFERENCE ONLY

DRAFT

FOR INFORMATION ONLY MARCH 03, 2023



BINNIE
The people behind your infrastructure.

R.F. BINNIE & ASSOCIATES LTD.
101 - 1577 7th Avenue,
Prince George, BC V2L 3P5
TEL 250 561 7274
BINNIE.com



BRITISH COLUMBIA
MINISTRY OF TRANSPORTATION AND INFRASTRUCTURE
NORTHERN REGION
HIGHWAY ENGINEERING AND GEOMATICS

DISPOSAL SITE 1 CROSS SECTIONS
HIGHWAY 16
GUEST ROAD AND SHALLOW BAY ROAD INTERSECTIONS

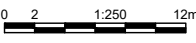
SCALE  CAD FILENAME 21-0125-1000XS-DISPOSAL.DWG
DATE 2023-03-01
FILE NUMBER 21-0125-00

REV	DATE	REVISIONS	SIGNATURE

DESIGNED	<u>J.D.</u>	DATE	<u>MAR_2023</u>
QUALITY CONTROL	<u>R.M.</u>	DATE	<u>MAR_2023</u>
QUALITY ASSURANCE	<u>M.C.</u>	DATE	<u>MAR_2023</u>
DRAWN	<u>J.D.</u>	DATE	<u>MAR_2023</u>

PROJECT NUMBER 38199-0000	REG 3	DRAWING NUMBER 110W1-4XS
-------------------------------------	-----------------	------------------------------------

R. Mankowske
ENGINEER OF RECORD
DATE 20230303

Mar. 1, 2023 - 11:17 AM P:\2021\21-0125-00 - CAD Files\CAD\H1\DrawingProduction\000_DisposalSite1\0125-1000XS-DISPOSAL

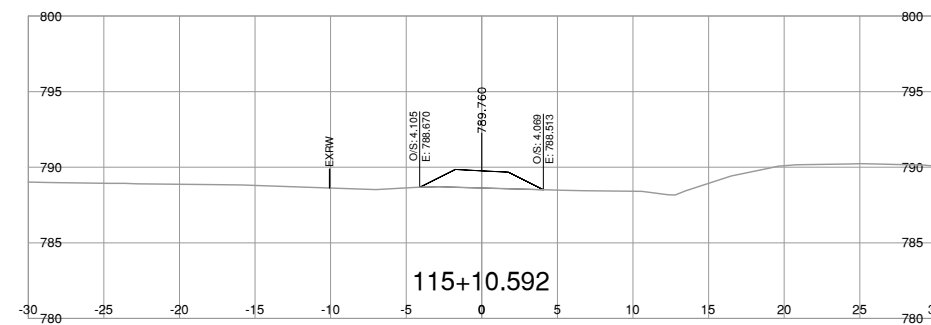
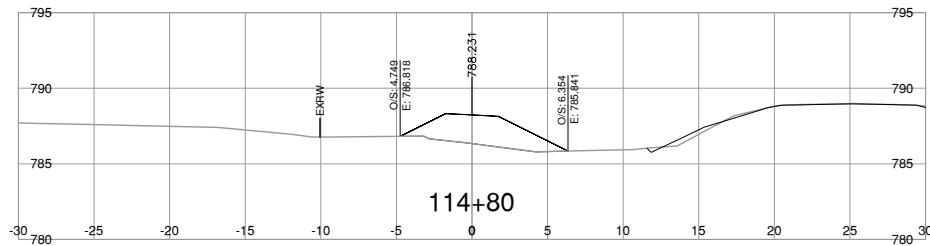
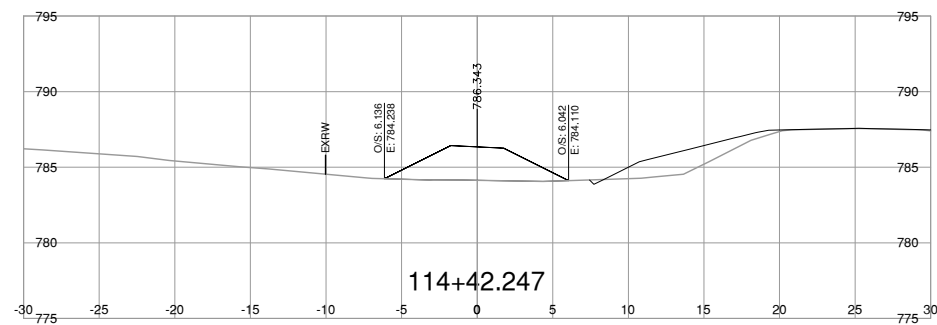
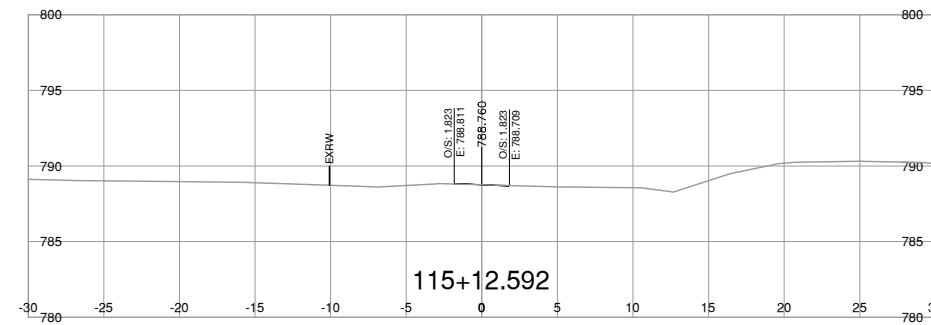
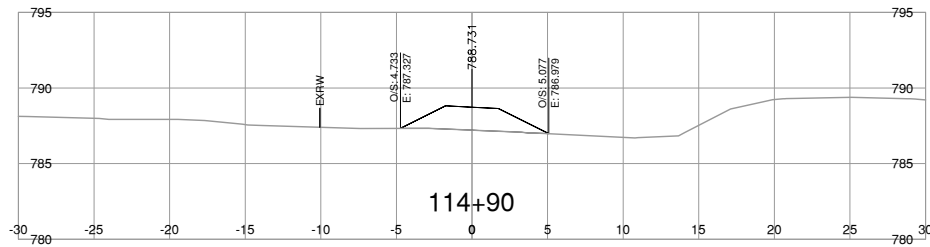
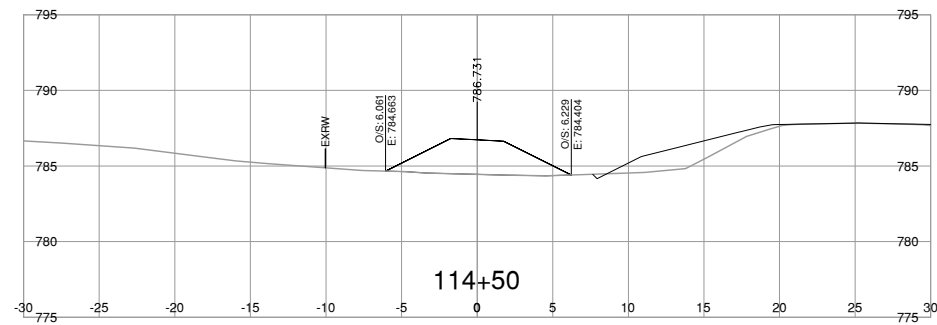
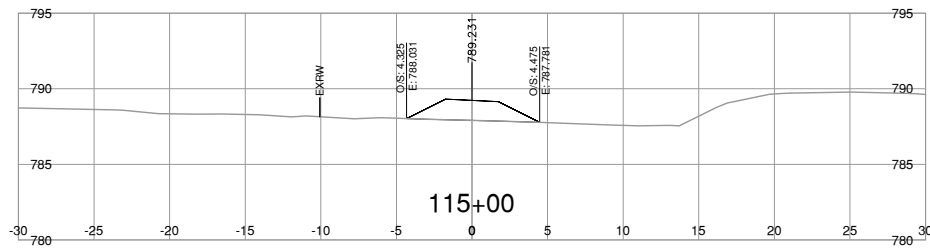
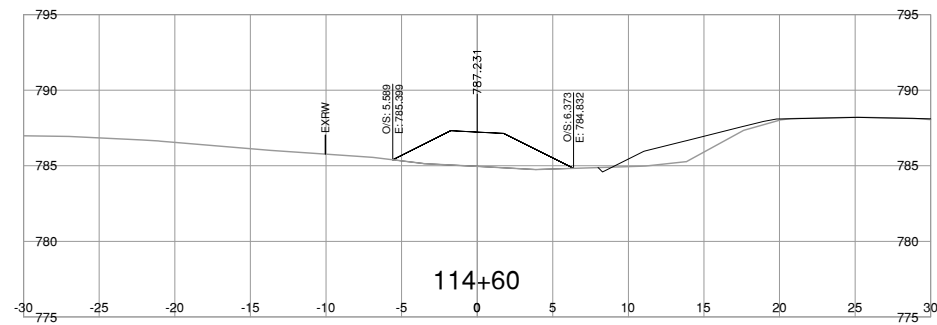
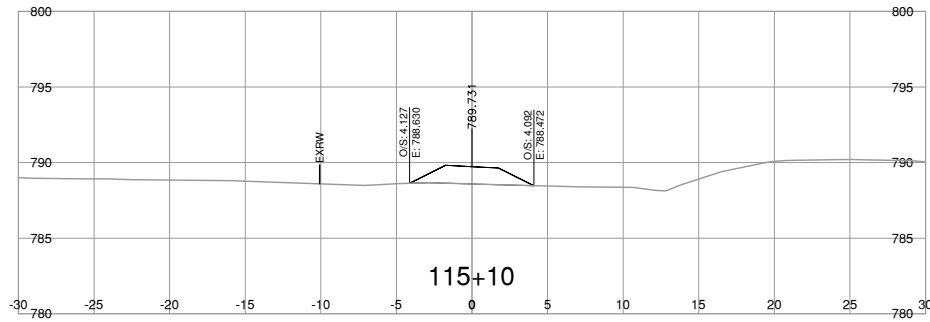
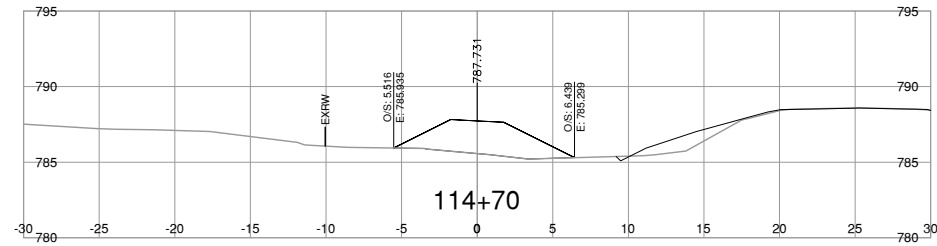

NOTE: STRIPPING REMOVAL APPLIES ONLY TO THE AREA BETWEEN SLOPE STAKE LINES (TOES & TOP OF CUT) OF PROPOSED ROADWAY TEMPLATE

FOR REFERENCE ONLY

DRAFT

FOR INFORMATION ONLY MARCH 03, 2023

<p>BINNIE The people behind your infrastructure.</p>	<p>R.F. BINNIE & ASSOCIATES LTD. 101 - 1577 7th Avenue, Prince George, BC V2L 3P5 TEL 250 561 7274 BINNIE.com</p>	<p>BRITISH COLUMBIA</p>	<p>MINISTRY OF TRANSPORTATION AND INFRASTRUCTURE NORTHERN REGION HIGHWAY ENGINEERING AND GEOMATICS</p>																																
				<p>DISPOSAL SITE 1 CROSS SECTIONS HIGHWAY 16 GUEST ROAD AND SHALLOW BAY ROAD INTERSECTIONS</p>																															
<p>SCALE CAD FILENAME: 21-0125-1000XS-DISPOSAL.DWG DATE: 2023-03-01 FILE NUMBER: 21-0125-00</p>		<table border="1"> <tr> <td>DESIGNED</td> <td>J.D.</td> <td>DATE</td> <td>MAR. 2023</td> </tr> <tr> <td>QUALITY CONTROL</td> <td>R.M.</td> <td>DATE</td> <td>MAR. 2023</td> </tr> <tr> <td>QUALITY ASSURANCE</td> <td>M.C.</td> <td>DATE</td> <td>MAR. 2023</td> </tr> <tr> <td>DRAWN</td> <td>J.D.</td> <td>DATE</td> <td>MAR. 2023</td> </tr> </table>		DESIGNED	J.D.	DATE	MAR. 2023	QUALITY CONTROL	R.M.	DATE	MAR. 2023	QUALITY ASSURANCE	M.C.	DATE	MAR. 2023	DRAWN	J.D.	DATE	MAR. 2023																
DESIGNED	J.D.	DATE	MAR. 2023																																
QUALITY CONTROL	R.M.	DATE	MAR. 2023																																
QUALITY ASSURANCE	M.C.	DATE	MAR. 2023																																
DRAWN	J.D.	DATE	MAR. 2023																																
<table border="1"> <thead> <tr> <th>REV</th> <th>DATE</th> <th>REVISIONS</th> <th>SIGNATURE</th> </tr> </thead> <tbody> <tr><td> </td><td> </td><td> </td><td> </td></tr> <tr><td> </td><td> </td><td> </td><td> </td></tr> <tr><td> </td><td> </td><td> </td><td> </td></tr> <tr><td> </td><td> </td><td> </td><td> </td></tr> <tr><td> </td><td> </td><td> </td><td> </td></tr> </tbody> </table>		REV	DATE	REVISIONS	SIGNATURE																					<p>R. Mankowske ENGINEER OF RECORD DATE 20230303</p> <table border="1"> <tr> <td>PROJECT NUMBER</td> <td>REG</td> <td>DRAWING NUMBER</td> <td>REV</td> </tr> <tr> <td>38199-0000</td> <td>3</td> <td>110W1-5XS</td> <td> </td> </tr> </table>		PROJECT NUMBER	REG	DRAWING NUMBER	REV	38199-0000	3	110W1-5XS	
REV	DATE	REVISIONS	SIGNATURE																																
PROJECT NUMBER	REG	DRAWING NUMBER	REV																																
38199-0000	3	110W1-5XS																																	

Mar. 1, 2023 - 11:17 AM P:\2021\21-0125-00 - CAD Files\CAD-Files\H1\Drawing\Production\000_Design\Sections\0125-1000XS-DISPOSAL

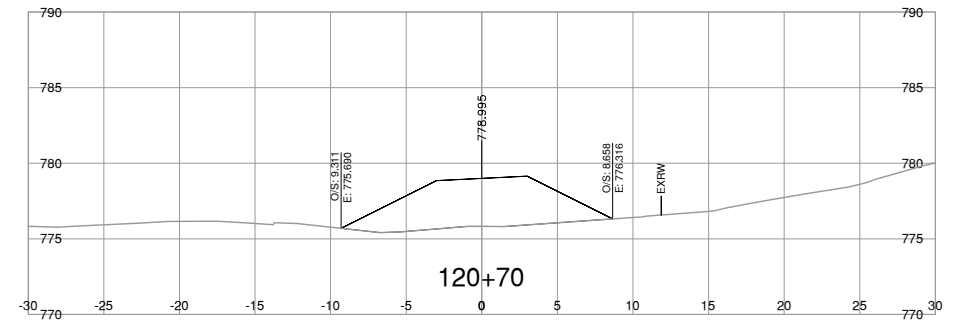
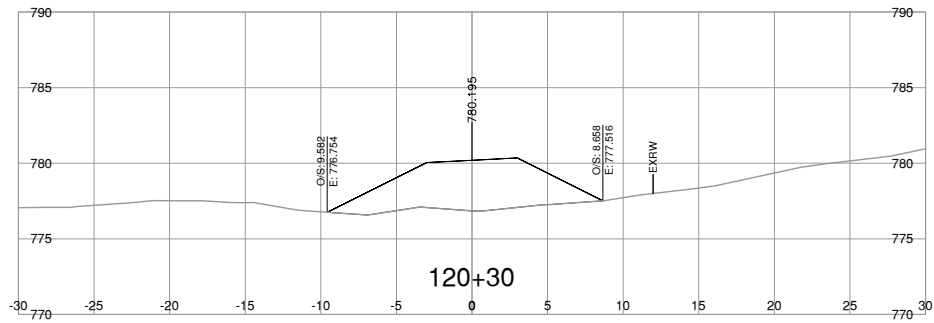
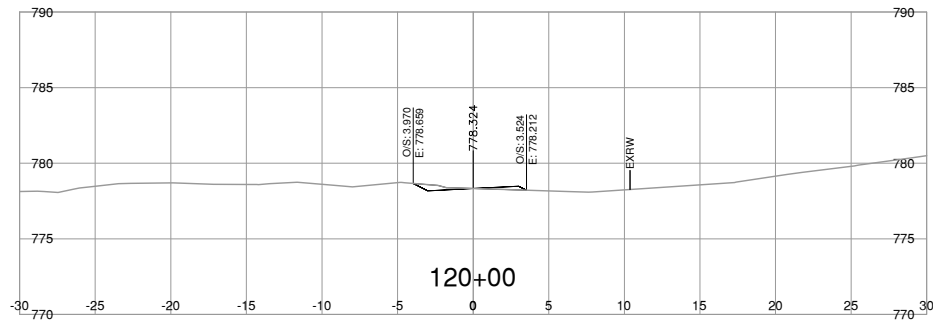
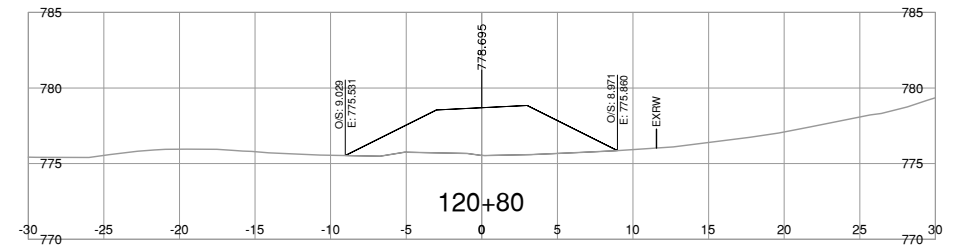
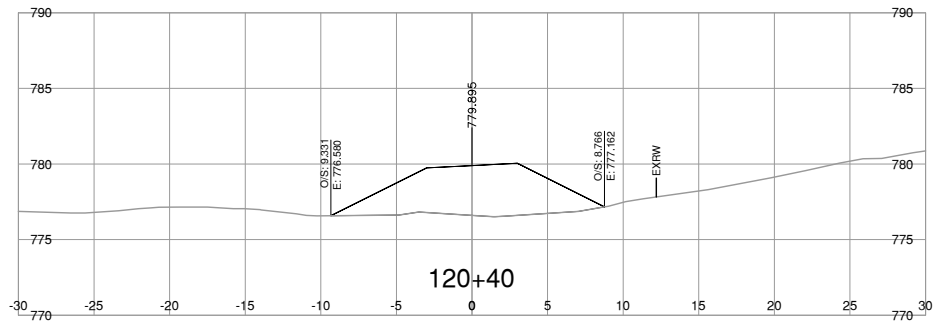
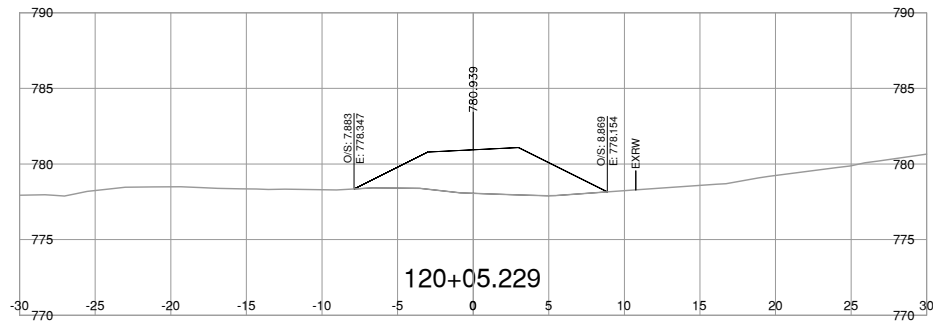
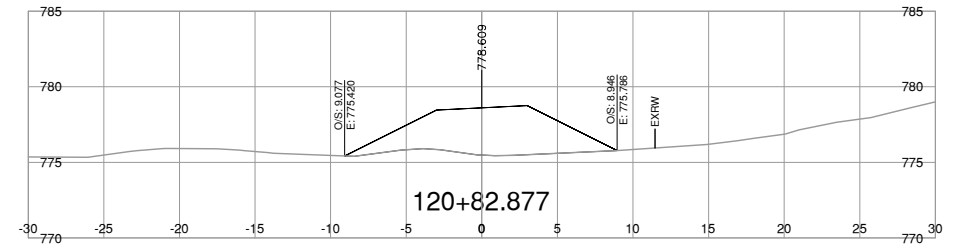
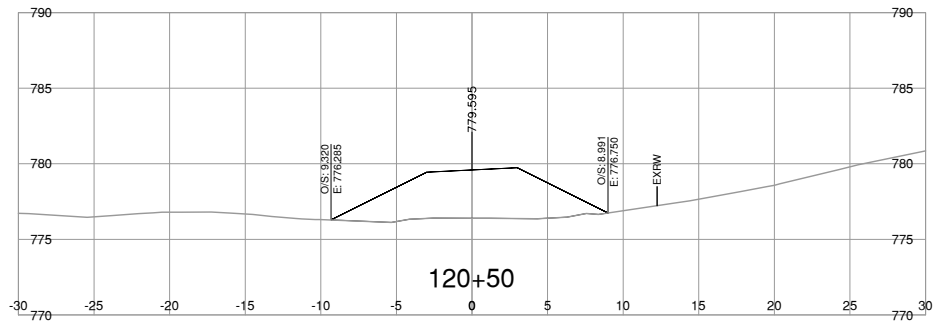
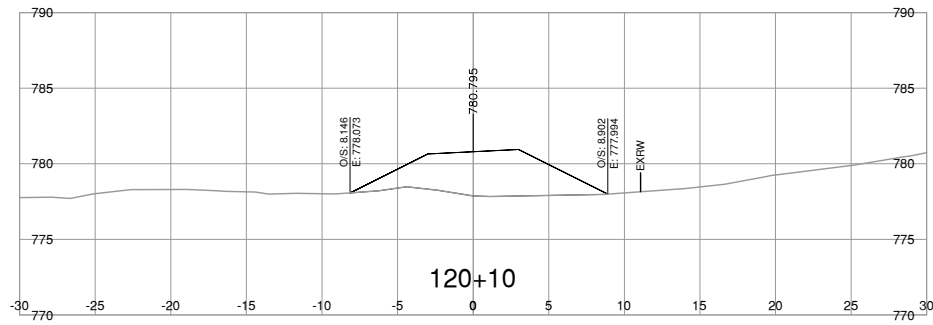
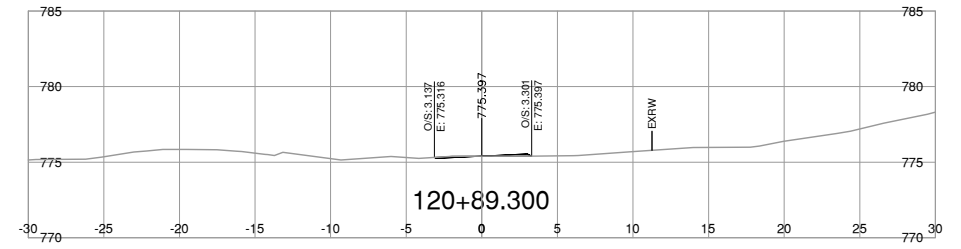
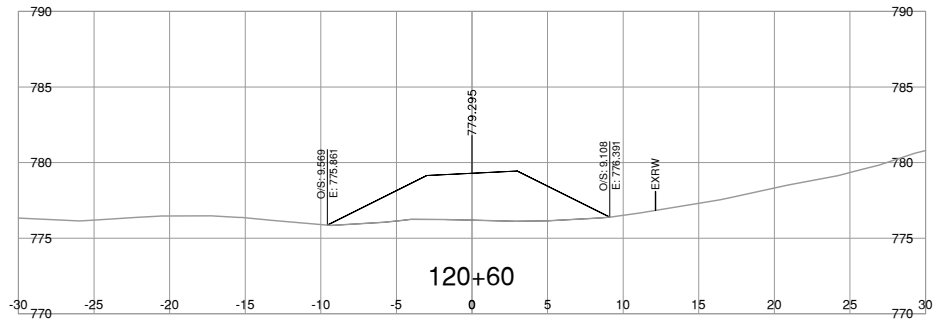
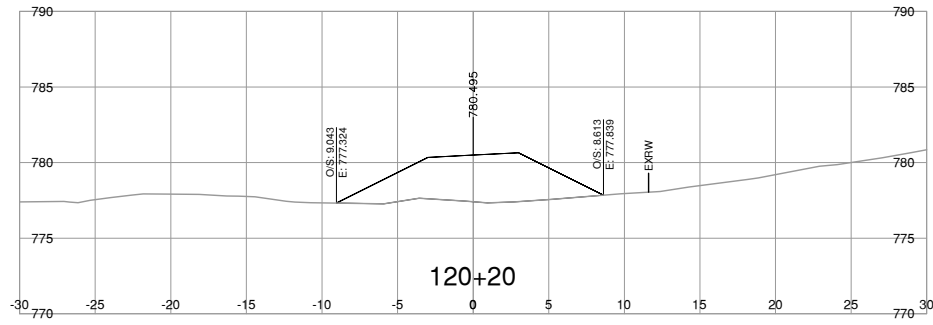

NOTE: STRIPPING REMOVAL APPLIES ONLY TO THE AREA BETWEEN SLOPE STAKE LINES (TOES & TOP OF CUT) OF PROPOSED ROADWAY TEMPLATE

FOR REFERENCE ONLY

DRAFT

FOR INFORMATION ONLY MARCH 03, 2023

<p>BINNIE The people behind your infrastructure.</p>	<p>R.F. BINNIE & ASSOCIATES LTD. 101 - 1577 7th Avenue, Prince George, BC V2L 3P5 TEL 250 561 7274 BINNIE.com</p>		<p>BRITISH COLUMBIA</p>	<p>MINISTRY OF TRANSPORTATION AND INFRASTRUCTURE NORTHERN REGION HIGHWAY ENGINEERING AND GEOMATICS</p>																												
	<p>SCALE </p> <p>CAD FILENAME: 21-0125-1000XS-DISPOSAL_DWG DATE: 2023-03-01 FILE NUMBER: 21-0125-00</p>	<p>DISPOSAL SITE 2 CROSS SECTIONS HIGHWAY 16 GUEST ROAD AND SHALLOW BAY ROAD INTERSECTIONS</p>																														
<table border="1"> <thead> <tr> <th>REV</th> <th>DATE</th> <th>REVISIONS</th> <th>SIGNATURE</th> </tr> </thead> <tbody> <tr><td> </td><td> </td><td> </td><td> </td></tr> <tr><td> </td><td> </td><td> </td><td> </td></tr> <tr><td> </td><td> </td><td> </td><td> </td></tr> <tr><td> </td><td> </td><td> </td><td> </td></tr> </tbody> </table>	REV	DATE	REVISIONS	SIGNATURE																	<p>DESIGNED: _____ J.D. DATE: MAR. 2023 QUALITY CONTROL: _____ R.M. DATE: MAR. 2023 QUALITY ASSURANCE: _____ M.C. DATE: MAR. 2023 DRAWN: _____ J.D. DATE: MAR. 2023</p>		<p>R. Mankowske ENGINEER OF RECORD DATE: 20230303</p>	<table border="1"> <tr> <td>PROJECT NUMBER</td> <td>REG</td> <td>DRAWING NUMBER</td> <td>REV</td> </tr> <tr> <td>38199-0000</td> <td>3</td> <td>120W1-1XS</td> <td> </td> </tr> </table>	PROJECT NUMBER	REG	DRAWING NUMBER	REV	38199-0000	3	120W1-1XS	
REV	DATE	REVISIONS	SIGNATURE																													
PROJECT NUMBER	REG	DRAWING NUMBER	REV																													
38199-0000	3	120W1-1XS																														

Mar. 1, 2023 - 11:17 AM P:\2021\21-0125-00 - CAD Files\CAD-Files\Drawings\Production\000_DisposalSite3\0125-1000XS-DISPOSAL

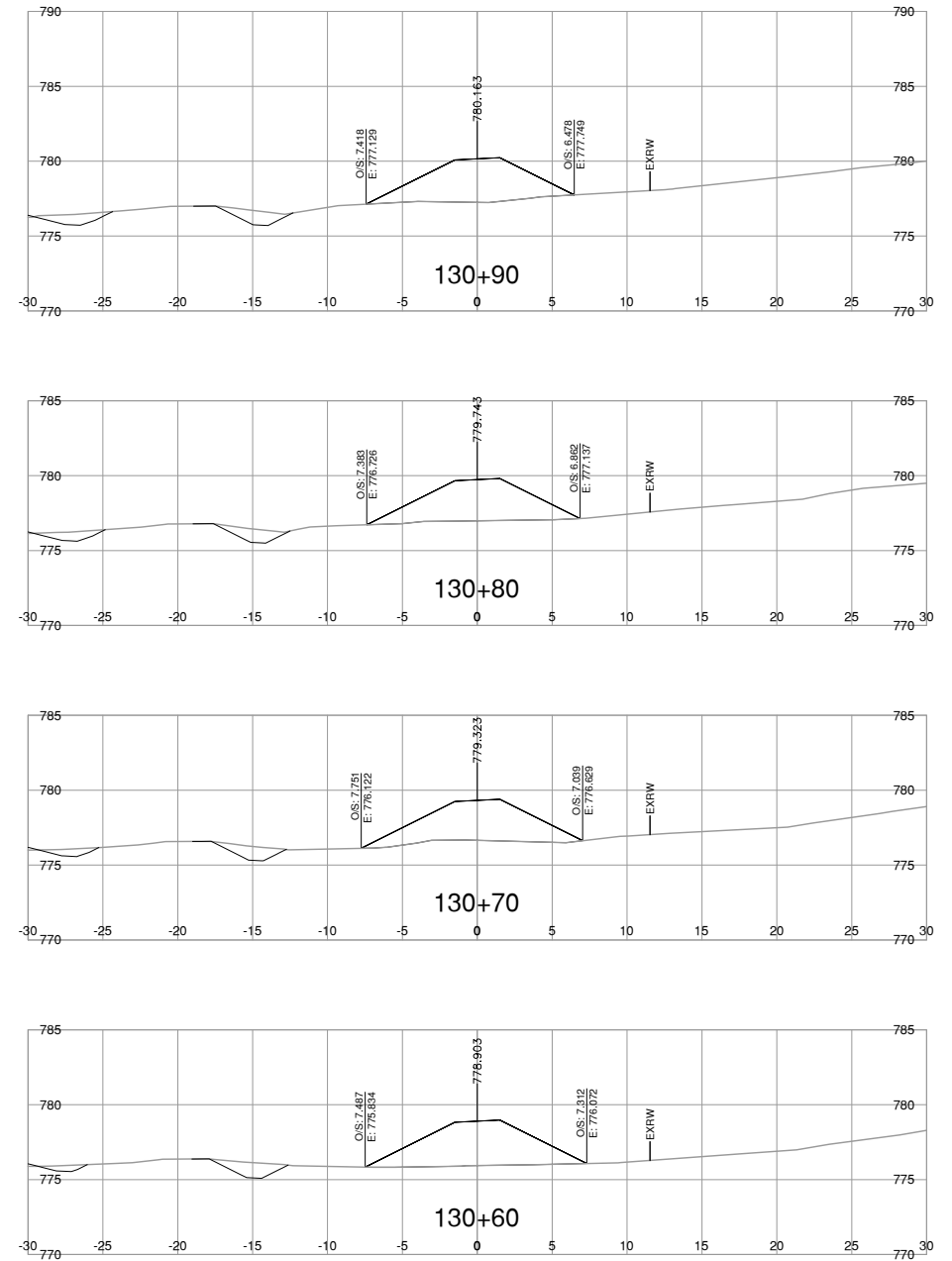
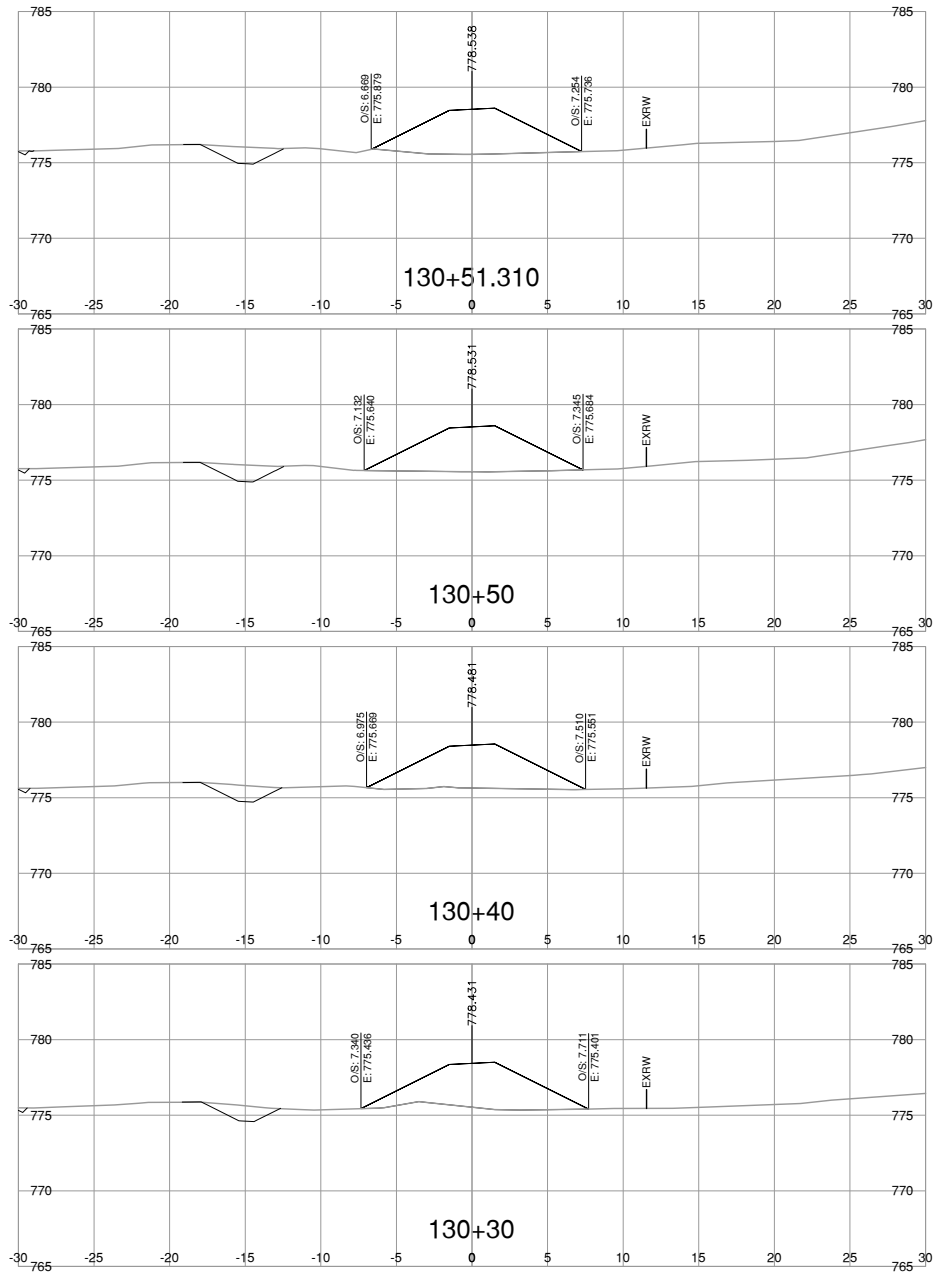
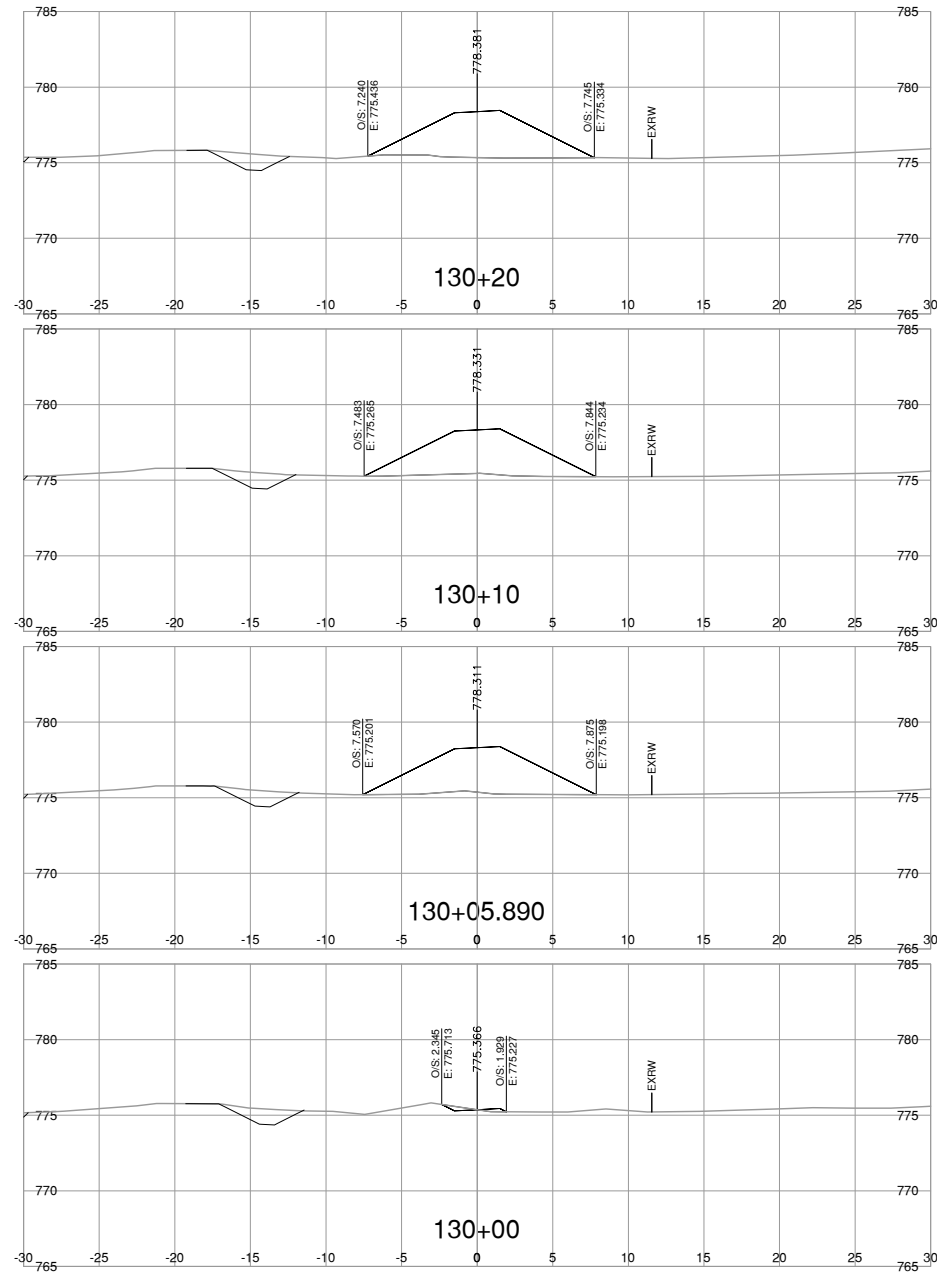

NOTE: STRIPPING REMOVAL APPLIES ONLY TO THE AREA BETWEEN SLOPE STAKE LINES (TOES & TOP OF CUT) OF PROPOSED ROADWAY TEMPLATE

FOR REFERENCE ONLY

DRAFT

FOR INFORMATION ONLY MARCH 03, 2023

BINNIE
The people behind your infrastructure.

R.F. BINNIE & ASSOCIATES LTD.
101 - 1577 7th Avenue,
Prince George, BC V2L 3P5
TEL 250 561 7274
BINNIE.com

SCALE 0 2 1:250 12m
CAD FILENAME 21-0125-1000XS-DISPOSAL_DWG
DATE 2023-03-01
FILE NUMBER 21-0125-00

REV	DATE	REVISIONS	SIGNATURE

BRITISH COLUMBIA

MINISTRY OF TRANSPORTATION AND INFRASTRUCTURE
NORTHERN REGION
HIGHWAY ENGINEERING AND GEOMATICS

DISPOSAL SITE 3 CROSS SECTIONS
HIGHWAY 16
GUEST ROAD AND SHALLOW BAY ROAD INTERSECTIONS

DESIGNED: J.D. DATE: MAR. 2023
 QUALITY CONTROL: R.M. DATE: MAR. 2023
 QUALITY ASSURANCE: M.C. DATE: MAR. 2023
 DRAWN: J.D. DATE: MAR. 2023

R. Mankowske
ENGINEER OF RECORD
DATE: 20230303

PROJECT NUMBER	REG	DRAWING NUMBER	REV
38199-0000	3	130W1-1XS	

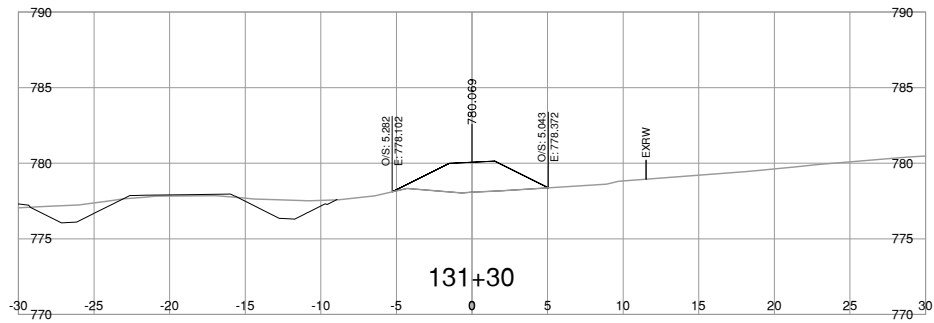
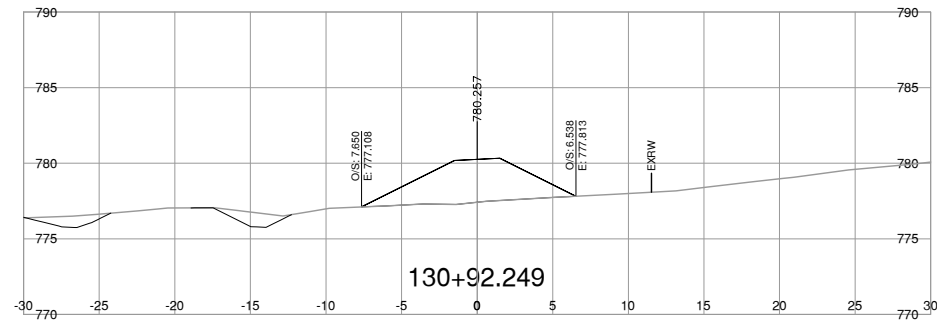
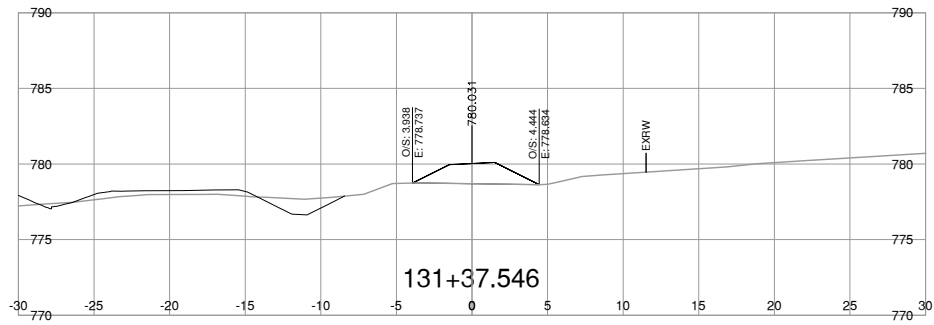
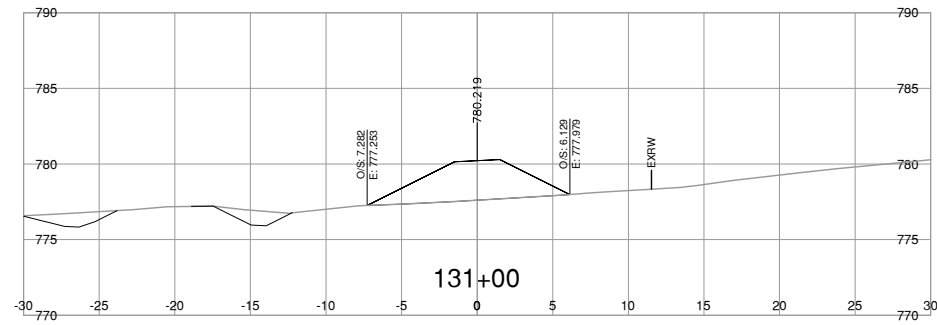
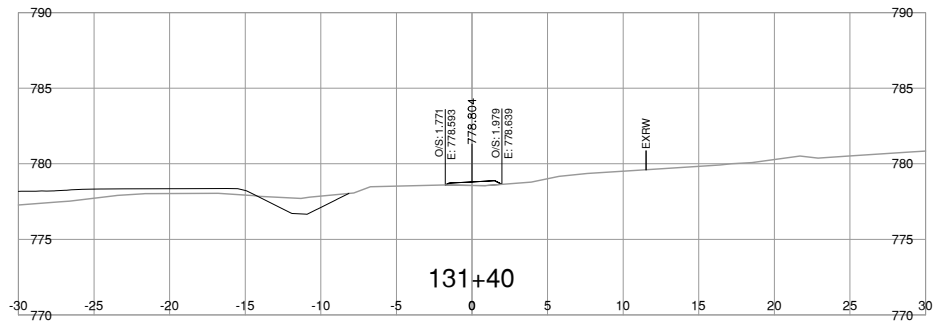
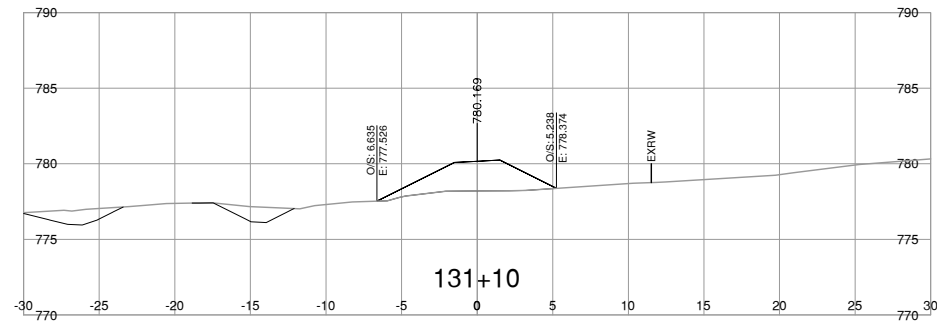
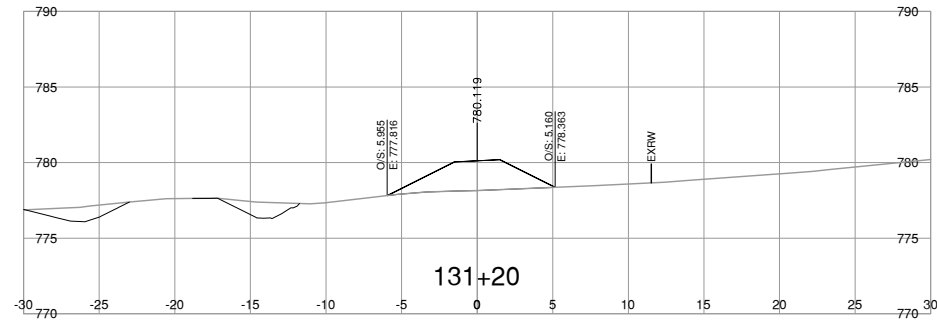

NOTE: STRIPPING REMOVAL APPLIES ONLY TO THE AREA BETWEEN SLOPE STAKE LINES (TOES & TOP OF CUT) OF PROPOSED ROADWAY TEMPLATE

FOR REFERENCE ONLY

DRAFT

FOR INFORMATION ONLY MARCH 03, 2023

BINNIE
The people behind your infrastructure.

R.F. BINNIE & ASSOCIATES LTD.
101 - 1577 7th Avenue,
Prince George, BC V2L 3P5
TEL 250 561 7274
BINNIE.com

BRITISH COLUMBIA
MINISTRY OF TRANSPORTATION AND INFRASTRUCTURE
NORTHERN REGION
HIGHWAY ENGINEERING AND GEOMATICS

DISPOSAL SITE 3 CROSS SECTIONS
HIGHWAY 16
GUEST ROAD AND SHALLOW BAY ROAD INTERSECTIONS

SCALE: 0 2 1:250 12m

CAD FILENAME: 21-0125-1000XS-DISPOSAL_DWG
DATE: 2023-03-01
FILE NUMBER: 21-0125-00

REV	DATE	REVISIONS	SIGNATURE

DESIGNED: _____ J.D. DATE: MAR. 2023
QUALITY CONTROL: _____ R.M. DATE: MAR. 2023
QUALITY ASSURANCE: _____ M.C. DATE: MAR. 2023
DRAWN: _____ J.D. DATE: MAR. 2023

PROJECT NUMBER: 38199-0000 REG: 3 DRAWING NUMBER: 130W1-2XS REV: _____

R. Mankowske
ENGINEER OF RECORD
DATE: 20230303

Mar. 1, 2023 - 11:17 AM P:\2021\21-0125-00 - CAD Files\CAD\H1\CrossR11\DrawingProduction\000_Dispos\SectDrawR_0125-1000XS-DISPOSAL

Mar. 1, 2023 - 11:17 AM P:\2021\21-0125-00 - CAD Files\CAD\H1\Drawings\Production\000_DisposalSite4\H1\DrawingProduction\000_DisposalSite4.dwg

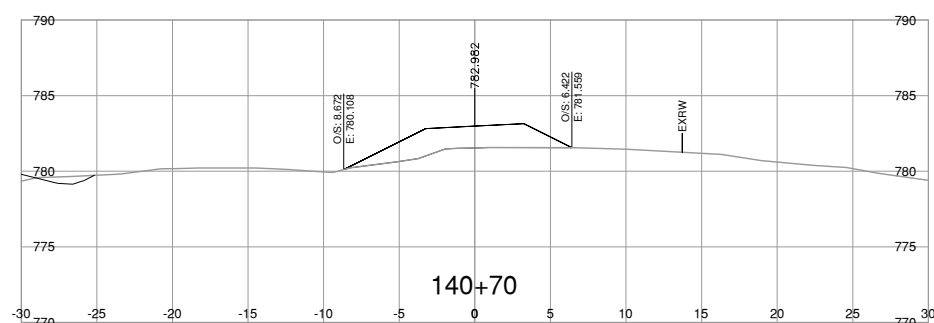
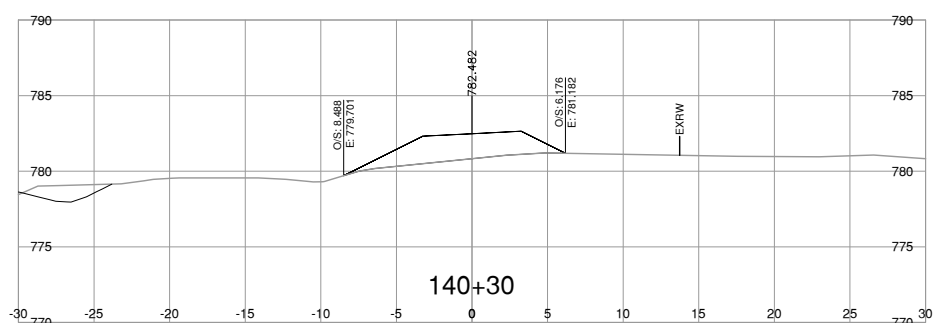
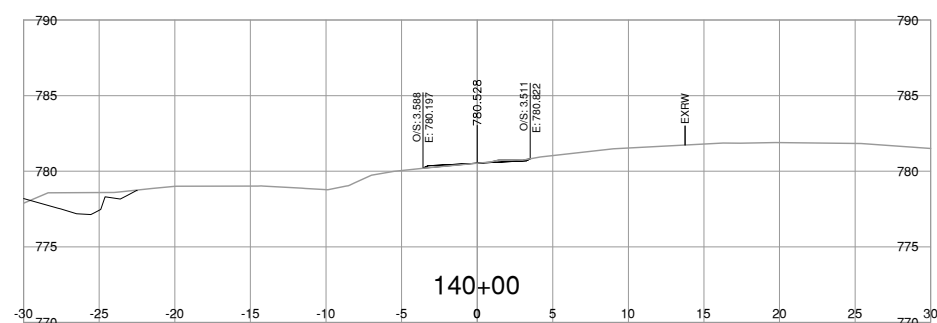
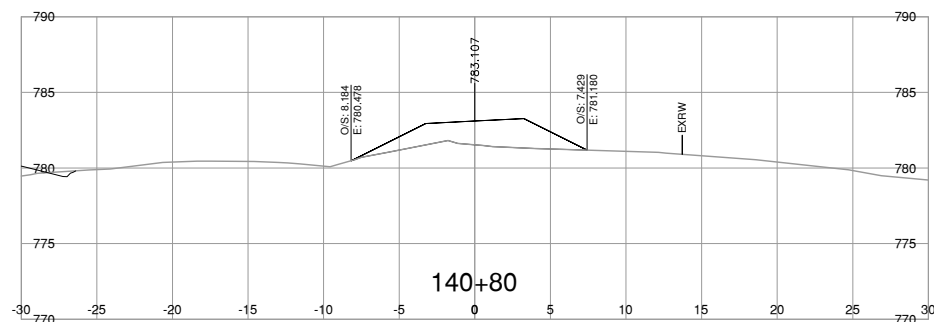
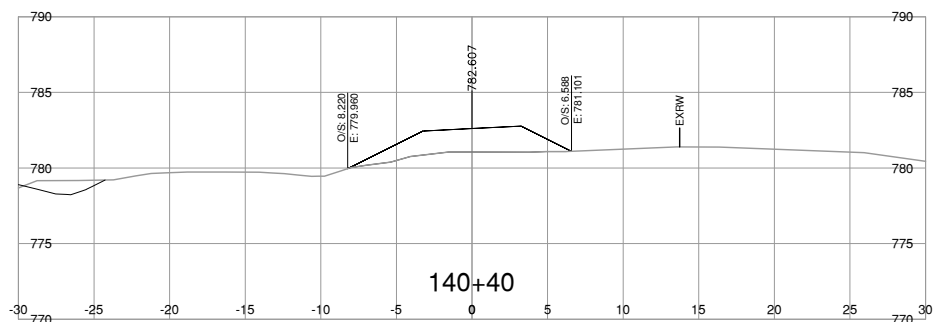
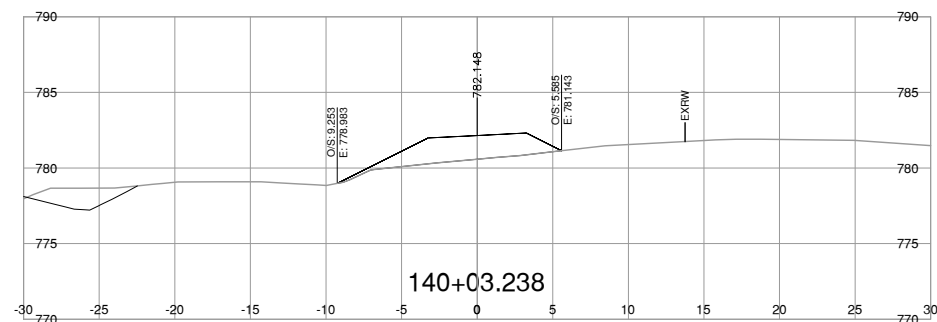
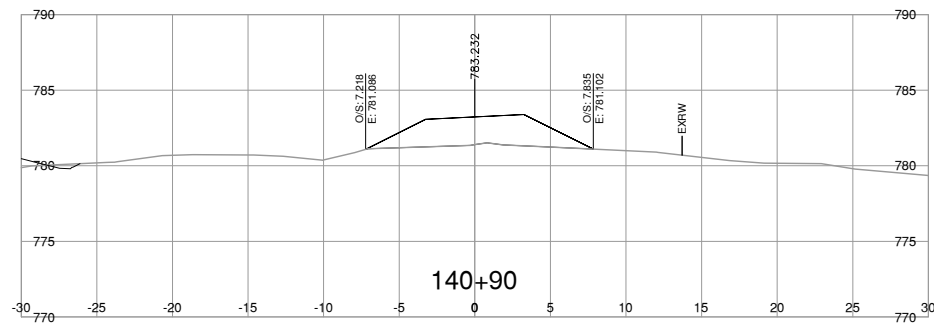
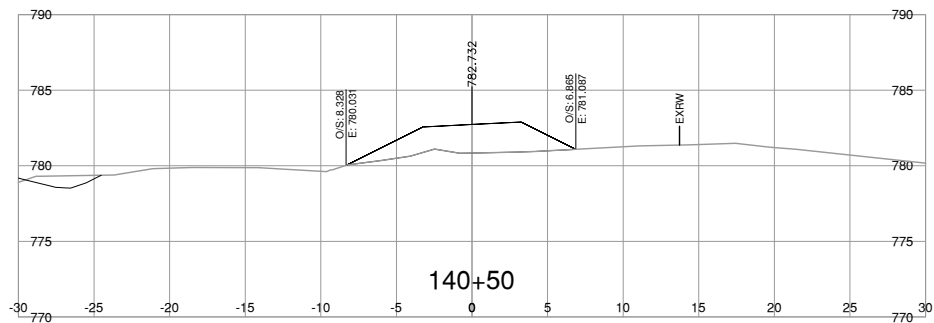
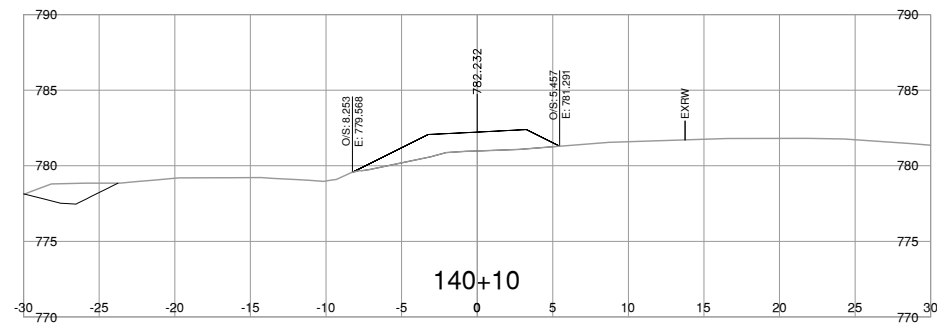
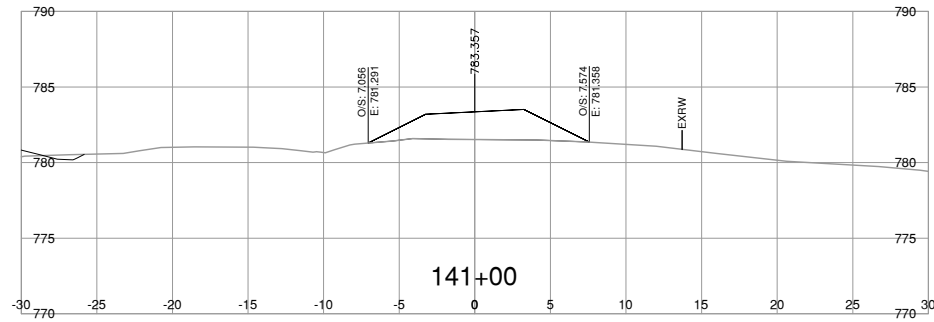
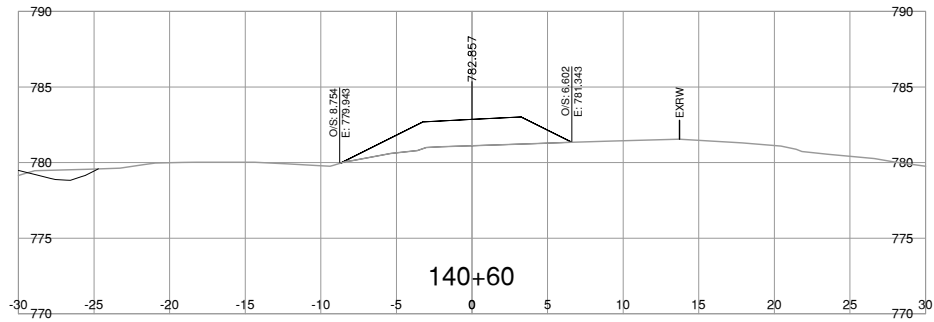
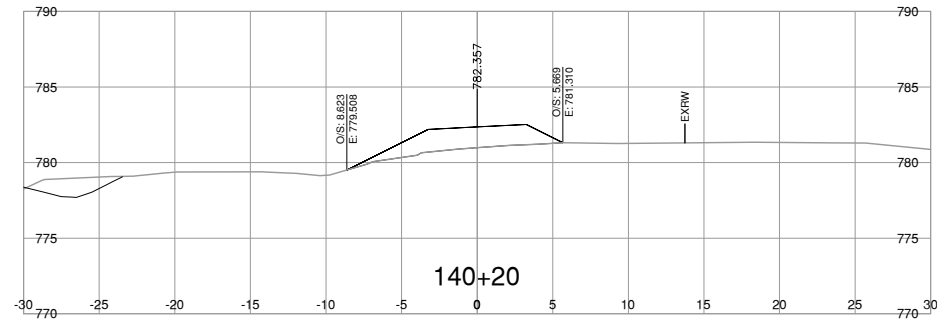

NOTE: STRIPPING REMOVAL APPLIES ONLY TO THE AREA BETWEEN SLOPE STAKE LINES (TOES & TOP OF CUT) OF PROPOSED ROADWAY TEMPLATE

FOR REFERENCE ONLY

DRAFT

FOR INFORMATION ONLY MARCH 03, 2023

BINNIE
The people behind your infrastructure.

R.F. BINNIE & ASSOCIATES LTD.
101 - 1577 7th Avenue,
Prince George, BC V2L 3P5
TEL 250 561 7274
BINNIE.com

BRITISH COLUMBIA

MINISTRY OF TRANSPORTATION AND INFRASTRUCTURE
NORTHERN REGION
HIGHWAY ENGINEERING AND GEOMATICS

DISPOSAL SITE 4 CROSS SECTIONS
HIGHWAY 16
GUEST ROAD AND SHALLOW BAY ROAD INTERSECTIONS

SCALE

CAD FILENAME: 21-0125-1000XS-DISPOSAL_DWG
DATE: 2023-03-01
FILE NUMBER: 21-0125-00

REV	DATE	REVISIONS	SIGNATURE

DESIGNED	J.D.	DATE	MAR_2023
QUALITY CONTROL	R.M.	DATE	MAR_2023
QUALITY ASSURANCE	M.C.	DATE	MAR_2023
DRAWN	J.D.	DATE	MAR_2023

R. Mankowske
ENGINEER OF RECORD
DATE 20230303

PROJECT NUMBER	REG	DRAWING NUMBER	REV
38199-0000	3	140W1-1XS	

Mar. 1, 2023 - 11:17 AM P:\2021\21-0125-00 - CAD Files\CAD\H1\DrawingProduction\000_DisposalSite4\H1\DrawingProduction\000_DisposalSite4.dwg

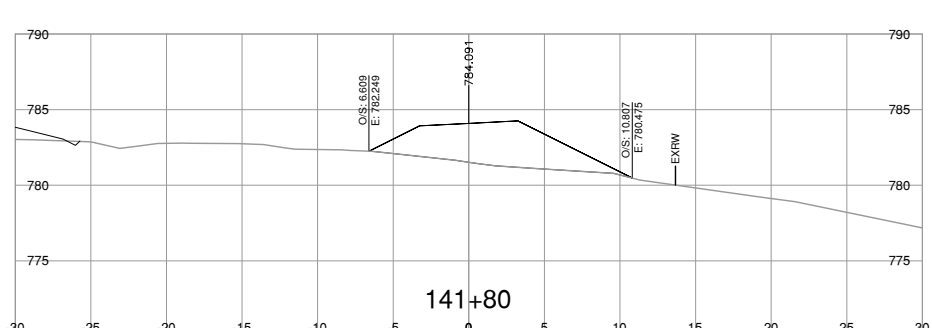
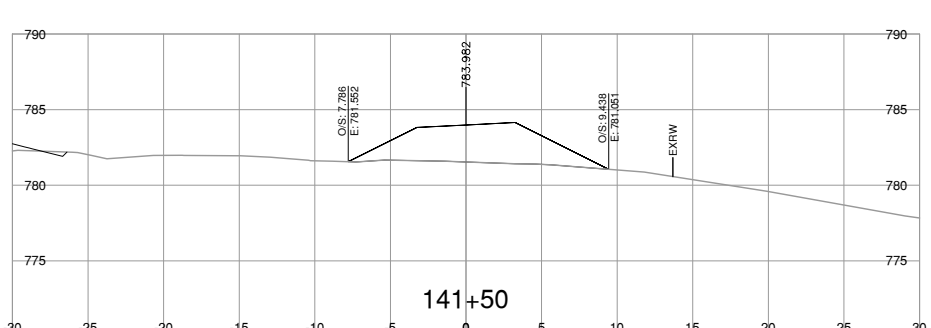
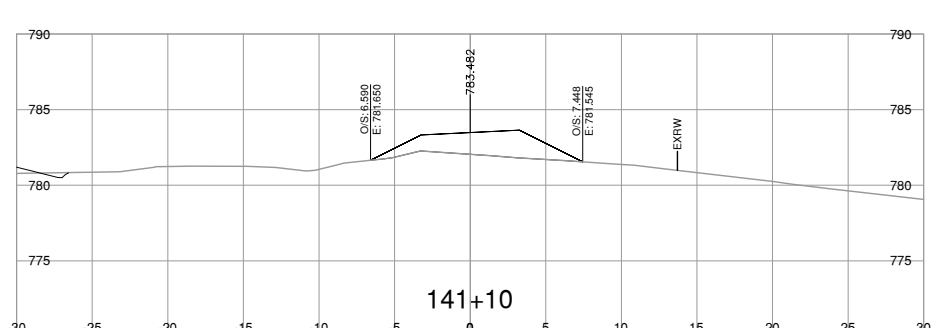
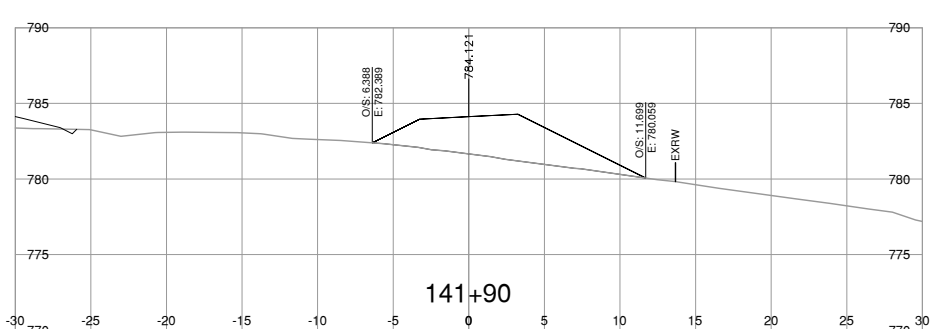
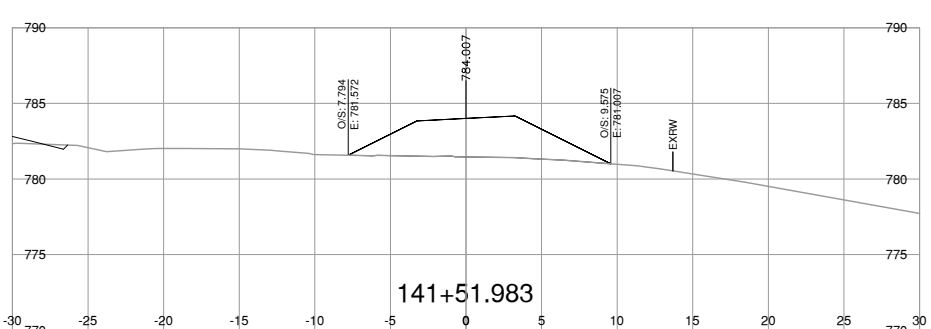
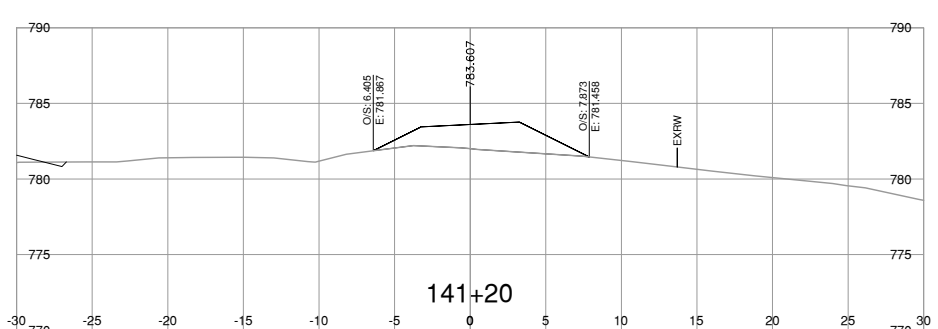
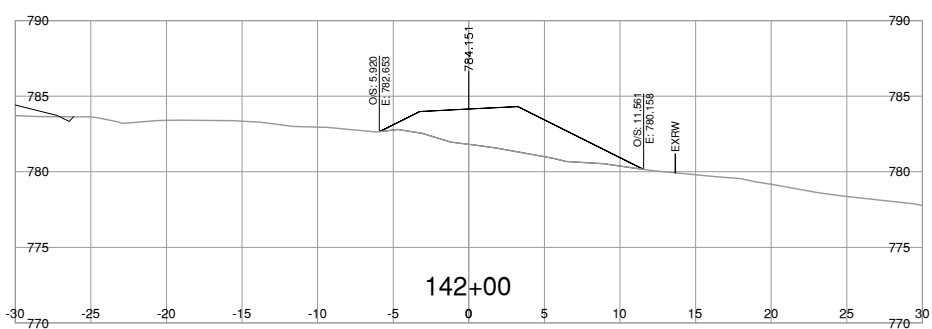
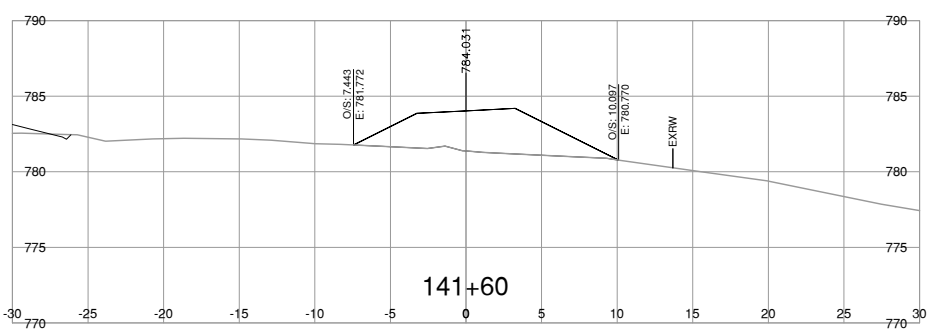
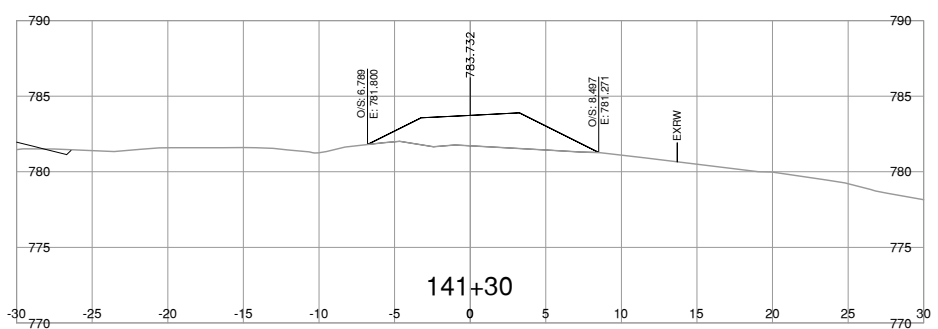
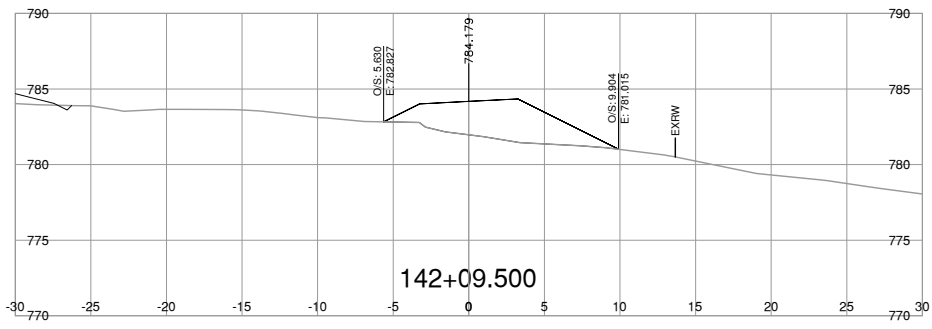
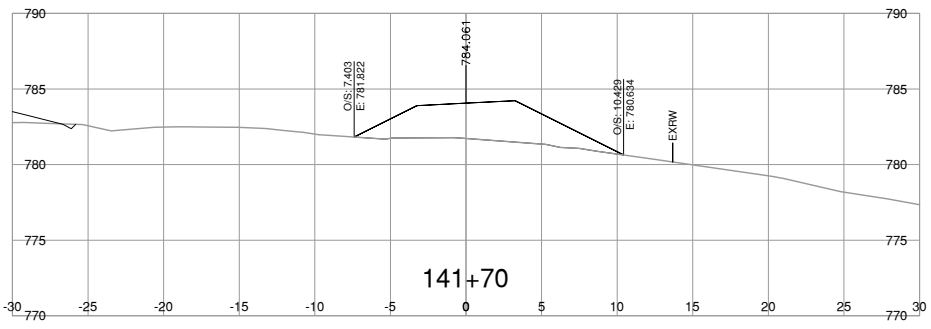
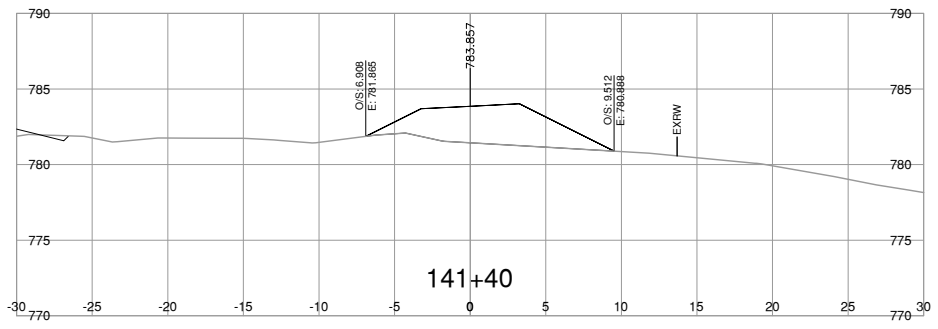

NOTE: STRIPPING REMOVAL APPLIES ONLY TO THE AREA BETWEEN SLOPE STAKE LINES (TOES & TOP OF CUT) OF PROPOSED ROADWAY TEMPLATE

FOR REFERENCE ONLY

DRAFT

FOR INFORMATION ONLY MARCH 03, 2023

BINNIE
The people behind your infrastructure.

R.F. BINNIE & ASSOCIATES LTD.
101 - 1577 7th Avenue,
Prince George, BC V2L 3P5
TEL 250 561 7274
BINNIE.com

BRITISH COLUMBIA

MINISTRY OF TRANSPORTATION AND INFRASTRUCTURE
NORTHERN REGION
HIGHWAY ENGINEERING AND GEOMATICS

DISPOSAL SITE 4 CROSS SECTIONS
HIGHWAY 16
GUEST ROAD AND SHALLOW BAY ROAD INTERSECTIONS

SCALE

CAD FILENAME: 21-0125-1000XS-DISPOSAL_DWG
DATE: 2023-03-01
FILE NUMBER: 21-0125-00

REV	DATE	REVISIONS	SIGNATURE

DESIGNED	J.D.	DATE	MAR. 2023
QUALITY CONTROL	R.M.	DATE	MAR. 2023
QUALITY ASSURANCE	M.C.	DATE	MAR. 2023
DRAWN	J.D.	DATE	MAR. 2023
PROJECT NUMBER	REG	DRAWING NUMBER	REV
38199-0000	3	140W1-2XS	

R. Mankowske
ENGINEER OF RECORD
DATE: 20230303

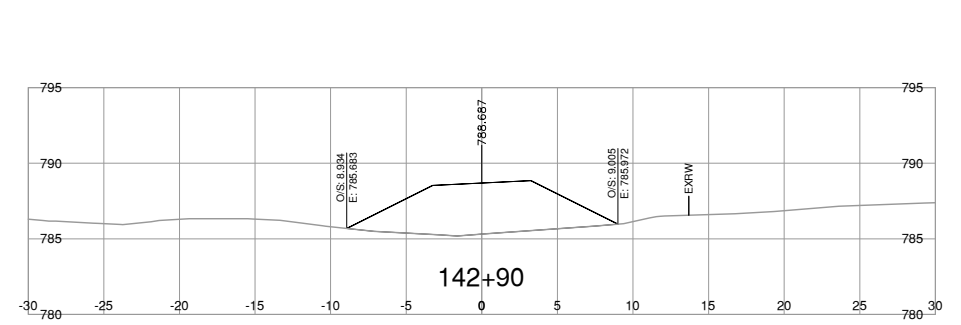
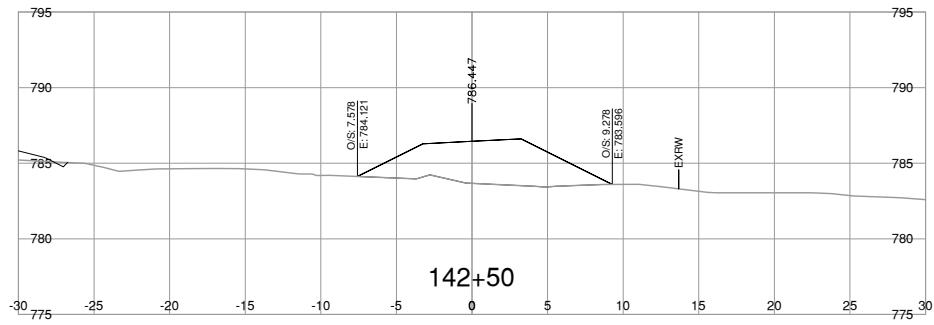
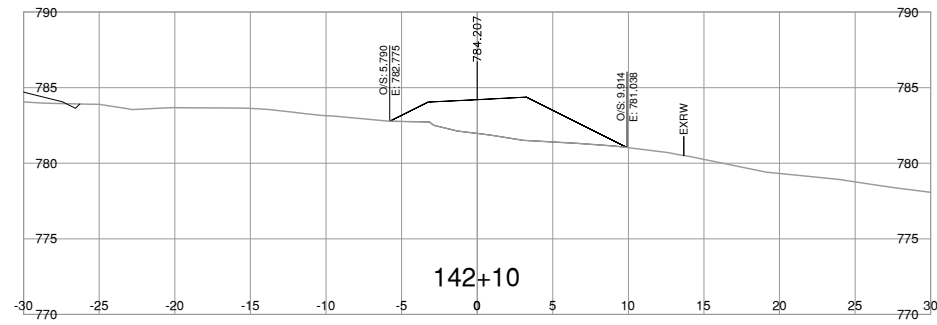
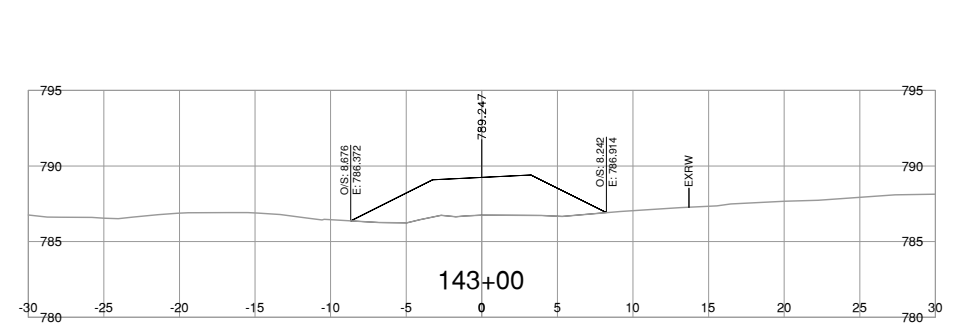
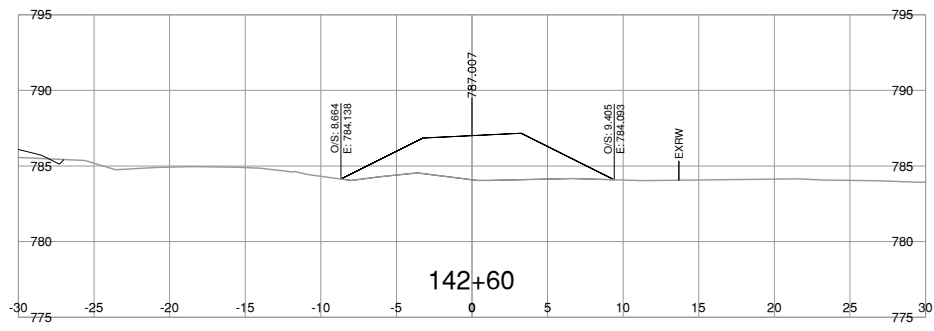
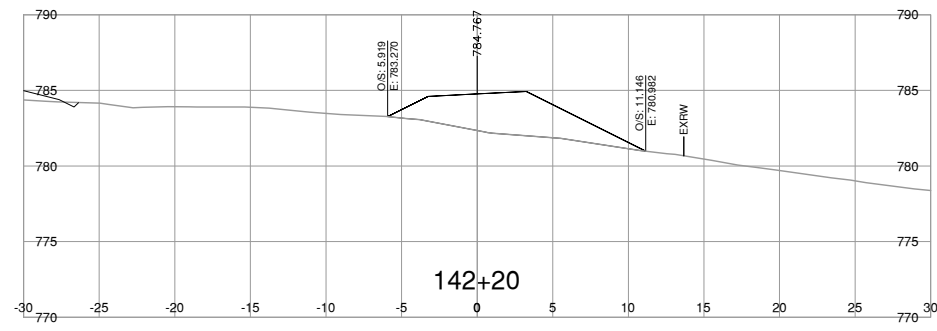
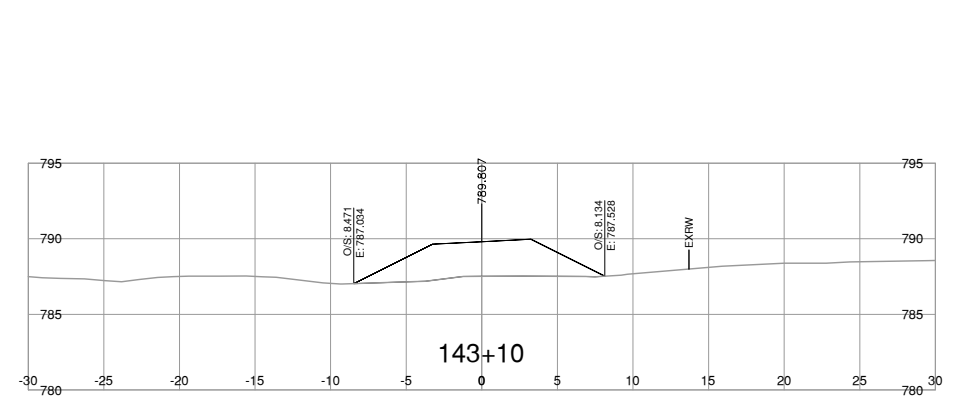
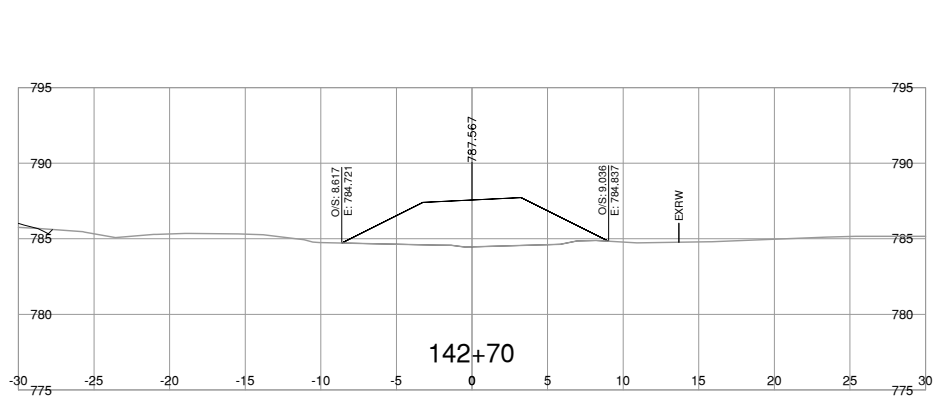
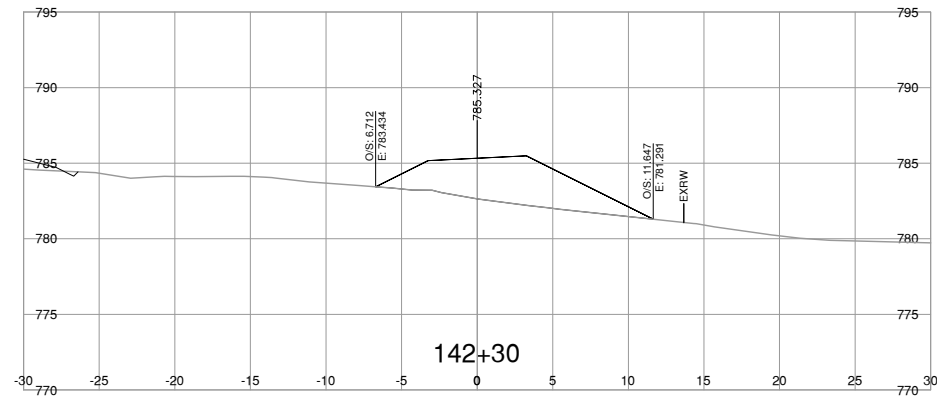
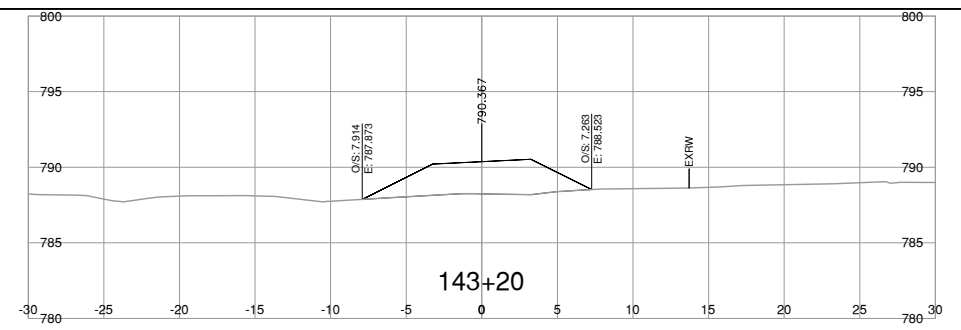
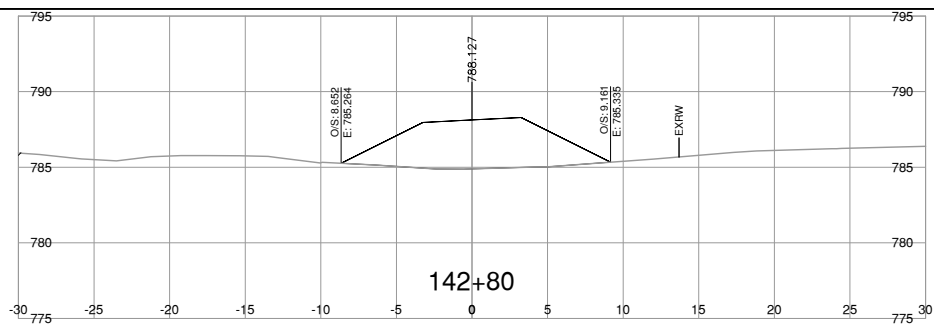
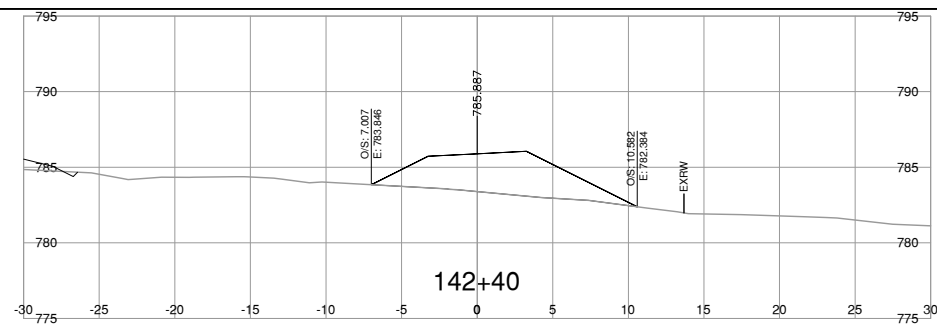

NOTE: STRIPPING REMOVAL APPLIES ONLY TO THE AREA BETWEEN SLOPE STAKE LINES (TOES & TOP OF CUT) OF PROPOSED ROADWAY TEMPLATE

FOR REFERENCE ONLY

DRAFT

FOR INFORMATION ONLY MARCH 03, 2023

BINNIE
The people behind your infrastructure.

R.F. BINNIE & ASSOCIATES LTD.
101 - 1577 7th Avenue,
Prince George, BC V2L 3P5
TEL 250 561 7274
BINNIE.com

SCALE 0 2 1:250 12m

CAD FILENAME 21-0125-1000XS-DISPOSAL_DWG
DATE 2023-03-01
FILE NUMBER 21-0125-00

REV	DATE	REVISIONS	SIGNATURE

BRITISH COLUMBIA

MINISTRY OF TRANSPORTATION AND INFRASTRUCTURE
NORTHERN REGION
HIGHWAY ENGINEERING AND GEOMATICS

DISPOSAL SITE 4 CROSS SECTIONS
HIGHWAY 16
GUEST ROAD AND SHALLOW BAY ROAD INTERSECTIONS

DESIGNED	J.D.	DATE	MAR. 2023
QUALITY CONTROL	R.M.	DATE	MAR. 2023
QUALITY ASSURANCE	M.C.	DATE	MAR. 2023
DRAWN	J.D.	DATE	MAR. 2023

R. Mankowske
ENGINEER OF RECORD
DATE 20230303

PROJECT NUMBER	38199-0000	REG	3	DRAWING NUMBER	140W1-3XS	REV	
----------------	------------	-----	---	----------------	-----------	-----	--

