



Revelstoke Remote Avalanche Control System (RACS) Geotechnical Design Report Panther (Path No. 48)

Presented To:



Dated: August 2023
Ecora File No.: 201740-04
MoTI Project No.: 26062

THIS PAGE IS INTENTIONALLY LEFT BLANK



Presented To:

BC Ministry of Transportation and Infrastructure
Southern Interior Region
447 Columbia Street
Kamloops, BC, B2C 2T3

Prepared by:



Dewald J. Kruger, M.Eng.
Geotechnical Consultant
dewald.kruger@ecora.ca

2023-08-04

Date

Reviewed & Approved by:

2023-08-04

Michael J. Laws, P.Eng.
Principal Dams & Geotechnics
michael.laws@ecora.ca

Date

Version Control and Revision History

Version	Date	Prepared By	Reviewed By	Notes/Revisions
0	2023-08-04	DJK	MJL	ISSUED FOR USE

Limitations of Report

This report and its contents are intended for the sole use of the BC Ministry of Transportation and Infrastructure, their agents, and the applicable regulatory authorities. Ecora Engineering & Resource Group Ltd. (Ecora) does not accept any responsibility for the accuracy of any data, analyses, or recommendations contained or referenced in the report when the report is used or relied upon by any Party other than the BC Ministry of Transportation and Infrastructure, their agents, the applicable regulatory authorities or for any Project other than that described in this report. Any such unauthorized use of this report is at the sole risk of the user.

Where Ecora submits both electronic file and hard copy versions of reports, drawings, and other project-related documents, only the signed and/or sealed versions shall be considered final and legally binding. The original signed and/or sealed version archived by Ecora shall be deemed to be the original for the Project. Both electronic file and hard copy versions of Ecora's deliverables shall not, under any circumstances, no matter who owns or uses them, be altered by any party except Ecora.

Table of Contents

1.	Introduction	1
1.1	General	1
1.2	Scope of Work.....	1
1.3	Site Description	1
2.	Background Review	2
2.1	Sources of Information	2
2.2	Background Review Summary	2
2.2.1	BC MoTI Snow Avalanche Atlas	2
2.2.2	Climate.....	3
2.2.3	Geology	3
2.2.4	Seismicity.....	3
2.2.5	Maintenance Contractor Rock Fall Records.....	4
3.	Geotechnical Characterization and Stability Analysis	4
3.1	General	4
3.2	UCS from Point Load Testing.....	4
3.3	Global Stability Analysis	5
3.3.1	General.....	5
3.3.2	Model Parameters	5
3.3.3	Results.....	5
4.	Design of RACS Tower Foundations	6
4.1	Design Criteria	6
4.2	Tower Foundation Design Loads	6
4.3	RACS Tower Foundation Design	6
4.3.1	General.....	6
4.3.2	Services Life Calculations	7
4.3.2.1	Design Criteria and Material Standards	7
4.3.2.2	Tower Foundation Minimum Threaded Bar Size	8
4.3.3	Frost Penetration	8
4.3.4	RACS Tower Foundation Design Summary.....	8
5.	Construction Considerations	9
5.1	Accessibility.....	9
5.2	Rock Scaling	9
5.3	Tree Felling	9
5.4	Quality Control Procedures	9

6. Closure..... 10

List of Tables in Text

Table 2-1 Columbia Program Path #48 Summary2
Table 2-2 Historical Weather Data Summary Albert Canyon Station #38227 (1999-2022)3
Table 2-3 “Site Class C” Design PGA and Sa(T) for the RACS at the Panther Priority Path3
Table 3-1 Hoek-Brown Criterion Input Parameters.....5
Table 3-2 Results of Limit Equilibrium Stability Analysis5
Table 4-1 Design Loads for Panther RACS Tower6
Table 4-2 Minimum Bond Length.....7
Table 4-3 Minimum Threadbar Size8
Table 4-4 RACS Tower Foundation Design Summary8

Appendix Sections

Figures

- Figure 3.1 Point Load Test Results.
- Figure 3.2 Stability Analysis Proposed Site.
- Figure 3.3 Stability Analysis Proposed Alternate Site.

Photographs

- Photo 1 Panther overview.
- Photo 2 Proposed Tower Locations and Helicopter Explosive Drop Placement Targets.
- Photo 3 Preferred Tower Location on Rock Ledge.
- Photo 4 Rock Mass Immediately Upslope of Preferred Tower Location.
- Photo 5 Panther Helicopter Landing Pad.

Appendix Sections

- Appendix A Design Drawings
- Appendix B Panther Desktop Report
- Appendix C Tower Foundation Calculations

Acronyms and Abbreviations

AEP	Annual Exceedance Probability	m asl	meter(s) above sea level
ASCE	American Society of Civil Engineers	MCRR	Maintenance Contractor Rockfall Reports
BC	(Province of) British Columbia	NBCC	National Building Code of Canada (2020)
BCBC	British Columbia Building Code (2018)	P.Eng.	Professional Engineer (registered with EGBC)
BC MoTI	British Columbia Ministry of Transportation and Infrastructure	PGA	Peak Ground Acceleration
CFEM	Canadian Foundation Engineering Manual	PLT	Point Load Test
CHBDC	Canadian Highway Bridge Design Code (2019)	PTI	Post-Tensioning Institute
CPR	Canadian Pacific Railway	RACS	Remote Avalanche Control System
DEM	Digital Elevation Model	Sa(T)	Spectral Acceleration
EGBC	Engineers and Geoscientists British Columbia	SSHC	Standard Specifications for Highways
FOS	Factor of Safety	TCH 1	Trans-Canada Highway 1
LiDAR	Light Detection and Ranging	UBC	University of British Columbia
LKI	Landmark Kilometer Inventory	UCS	Uniaxial Compressive Strength

1. Introduction

1.1 General

Ecora Engineering & Resource Group Ltd. (Ecora) has been retained by the British Columbia Ministry of Transportation and Infrastructure (BC MoTI) to provide engineering services for several proposed Remote Avalanche Control System (RACS) sites to be situated along the Trans-Canada Highway (TCH) near Revelstoke, British Columbia (BC).

It is proposed that a Wyssen Avalanche Control (Wyssen) RACS tower be constructed at the Panther site, which is approximately 46 km east of Revelstoke in BC. The Wyssen RACS towers are between 8 and 12 m tall and are inclined to overhang an avalanche initiation zone. The system allows the BC MoTI to undertake avalanche control during all weather conditions, at any time, thereby reducing the risk of uncontrolled avalanches impacting highway traffic and allows the BC MoTI to better manages its assets.

This work was approved by Andre van Wyk PmP, Senior Project Manager with Stites Consulting Inc. (Stites). The work will be carried out in accordance with applicable BC MoTI Standards and Technical Circulars, the Professional Governance Act (2021), and relevant Professional Practice Guidelines, as published by Engineers and Geoscientists British Columbia (EGBC).

1.2 Scope of Work

This design report addresses Tasks 2.3 Detailed Design Verification and 2.4 Detailed Design Report as provided in Ecora's Geotechnical Proposed Work Plan TransCanada Highway (Hwy 1) – RACS-TCH Revelstoke East and West Detailed Design as follows:

- Rock fall run out assessment.
- Micro-pile and inclined shear relief anchor design.
- Kinematic stability analysis.
- Global stability analysis.
- Structural pile cap design.
- Preparation of detailed design drawings.

1.3 Site Description

The TCH is a major transcontinental west-east highway that traverses the breadth of Canada between the Pacific and Atlantic Oceans. Within British Columbia (BC) it traverses through a number of mountain passes, which are subject to seasonal avalanches. The Panther Priority Path is located just outside the western boundary of Glacier National Park, BC, approximately 300 m east of the Jack MacDonald snowshed, and 425 m west of the Twins snowshed.

The Panther Priority Path is located on a southeast facing slope in the Selkirk Mountain range and lies at an elevation between 1,300 m above sea level (m asl) to 920 m asl (TCH 1 elevation). The Illecillewaet River flows parallel to the TCH 1 (downslope) and drains into Upper Arrow Lake to the west.

Two proposed tower locations have been identified during a site visit on 13 June 2023, which are indicated on the design drawings in provided Appendix A. Both the proposed tower location and proposed alternate tower location

fall within the avalanche initiation area, and the two locations have been evaluated geotechnically for suitability for the construction of the tower.

Ecora has previously undertaken a desktop assessment of the Panther site which provide a more detailed description of site conditions, which is attached as Appendix B.

Overall, site is characterized by steep rock faces with little to no overburden materials observed. Dense vegetation coverage, predominantly mature conifers, and sparse shrubs are located in the vicinity of the proposed tower location area. Further details describing the geotechnical conditions of the site are provided in Section 3.

2. Background Review

2.1 Sources of Information

Ecora reviewed the following relevant background information related to the project.

- BC MoTI Columbia Program Snow Avalanche Atlas (BC MoTI, 2015).
- BC MoTI Road Weather Stations (RWS) data.
- Readily available published sources of geologic data.
- The National Resources Canada (NRCan) seismic hazard information.
- MC MoTI Maintenance Contractor Rock Fall Reports (MCRR) records for the Panther area
- Revelstoke Remote Avalanche Control Systems (RACS), Site Reconnaissance Report (Ecora, 2023).
- Revelstoke Remote Avalanche Control Systems (RACS), Desktop Assessment Panther Report (Ecora, 2023).

2.2 Background Review Summary

2.2.1 BC MoTI Snow Avalanche Atlas

Table 2-1 has been adapted from BC MoTI Columbia Program Snow Avalanche Atlas (BC MoTI, 2015), and serves as a summary of Panther Path #48.

Table 2-1 Columbia Program Path #48 Summary

Panther Terrain Characteristics Path Number: 48		
Terrain Characteristics:		
Vertical Fall: 455 m	Starting Zone: 1370 m asl - 1220 m asl	
Aspect: Southeast	Runout Zone: 915m asl - 915 m asl	
Slope:		
Starting Zone: 38°	Track: 40°	Runout Zone: 0°
Slope Hazards:		
Type: Avalanche, Sluffing	Event Frequency: 1 per year (12-month return period)	
Infrastructure in Path:		
Road Width: 7 m	Road Length: ~35m	

2.2.2 Climate

The BC MoTI weather station RWS Albert Canyon (Station Code: 38227) is located approximately 3.5 km southwest of the Panther Priority Path site, at an elevation of approximately 870 m asl, and provides historical weather records relevant to the site between November 23, 1999, and October 17, 2022. Data was collected twice per day at 06:00 hours and 18:00 hours; however, only between the months of October to April, annually.

The RWS Albert Canyon weather station data indicates that the average daily maximum temperature generally remains below freezing ($<0^{\circ}\text{C}$) between November through to February. Average monthly new snow accumulation peaks in January (3.16 m), while the average total snowpack peaks in February (1.19 m). Table 2-2 provides a summary of the average minimum and maximum temperatures, average monthly sum of new snow, and average total snowpack for the months of October through to April, recorded at the RWS Albert Canyon station between 1999 and 2022.

Table 2-2 Historical Weather Data Summary Albert Canyon Station #38227 (1999-2022)

Month	Average Maximum Temperature ($^{\circ}\text{C}$)	Average Minimum Temperature ($^{\circ}\text{C}$)	Average Monthly Sum of New Snow (m)	Average Total Snowpack (m)
October	6.8	1.6	0.99	0.05
November	-0.3	-3.1	1.46	0.21
December	-4.3	-7.3	2.33	0.62
January	-3.6	-7.0	3.16	0.98
February	-1.5	-6.9	2.54	1.19
March	3.35	-2.9	2.69	1.10
April	8.29	-0.58	1.03	0.53

2.2.3 Geology

MapPlace2 (beta) (Cui et al., 2017) indicates the underlying geology at the Panther Priority Path consists of mudstone, siltstone, and shale, including fine clastic sedimentary rocks (namely micaceous schist); and impure marble from the Index Formation of Cambrian to Devonian age.

2.2.4 Seismicity

The *Bridge Standards and Procedures Manual, Supplement to CHBDC S6-19* (MoTI, 2022) stipulates that structures shall be designed for no-collapse under multiple earthquake design levels (475, 975, and 2,475), with peak ground acceleration (PGA) values as determined by the GSC and reported in the National Building Code of Canada (NBCC, 2020).

The GSC has developed a probabilistic (6th Generation) seismic hazard model (Kolaj et al., 2020) that forms the basis of the seismic design provisions of the 2020 National Building Code of Canada (NBCC, 2020), British Columbia Building Code (BCBC, 2018), and Canadian Highway Bridge Design Code (CHBDC; CSA, 2019).

Peak Ground Accelerations (PGA) and Spectral Accelerations (Sa(T)) for a reference “Site Class C” (very dense soil and soft rock) can be obtained from the Earthquakes Canada website for various return periods, with the reference values for the proposed RACS at the Panther Priority Path is summarized in Table 2-3 below.

Table 2-3 “Site Class C” Design PGA and Sa(T) for the RACS at the Panther Priority Path

Annual Exceedance Probability (AEP)	PGA (g)	Sa (0.2) (g)	Sa (0.5) (g)	Sa (1.0) (g)	Sa (2.0) (g)
1/475	0.0355	0.0827	0.0622	0.0364	0.021
1/1,000	0.0565	0.134	0.0961	0.0548	0.0325
1/2,475	0.0963	0.233	0.161	0.0879	0.0529

2.2.5 Maintenance Contractor Rock Fall Records

The BC MoTI provided Maintenance Contractor Rockfall Report (MCRR) records for the Panther Priority Path area at LKI km 45.96 to km 46.0 (RFI LM km 0.35 to km 0.39), between 1994 and 2018. No events were recorded in the immediate vicinity of the Panther Priority Path.

The MCRR reports indicate that 1 event has occurred and reached the highway at the closest location at the Jack MacDonald Snowshed, at approximately LKI km 45.67.

The relatively low number of rock fall events for the Panther Priority Path is in part attributed to the dense vegetation coverage and poor rock quality at the site.

3. Geotechnical Characterization and Stability Analysis

3.1 General

Reliable estimates of the strength and deformation characteristics of rock masses are required to evaluate the stability of rock slopes and rock foundations. The strength and deformability of a jointed rock mass depends on both the properties of the intact rock pieces as well as the freedom of these pieces to slide and rotate relative to each other. Generally speaking, the stability of a rock slope depends on the rock mass properties where, for stronger rocks, rock mass structure likely governs, whereas for weaker rocks, intact rock strength can be the governing factor (Read and Stacey, 2009).

In weaker rock or soils, typically rotational slips occur where movement takes place along a curved shear surface in such a way that the slipping mass slumps down near the top of the slope and bulges near the toe.

In stronger rock, the stability of the slope is frequently controlled by the orientation of discontinuities within the rock mass. Reliable knowledge of the true orientation of discontinuities is therefore required for engineering design. Structurally controlled failure in rock usually occurs as a result of slip or failure along (or from pre-existing geological discontinuities).

The rock mass at the Panther site can be described to consist of grey and light grey, highly weathered, thinly bedded (1 mm) metasedimentary-like, weak rock. The rock mass structure can be described as massive, and the stability has been evaluated to be controlled by the intact rock strength. To evaluate the stability of the rock mass, the results of a slope stability analysis are presented in the sections that follow.

3.2 UCS from Point Load Testing

Samples were collected from the proposed tower location for Point Load Testing (PLT). Calculation of the PLT test results were carried out in accordance with ASTM D 5731-16 standard.

The PLT results can be empirically correlated to UCS, which is the commonly accepted indicator of rock strength. The standard conversion formula to estimate UCS from I_{S50} values is as follows:

$$UCS = C * I_{s50}$$

A correlation factor C of 20-25 was used, as an initial estimate (Wyllie, 2018). Using the range of I_{s50} values, Ecora calculated an approximate UCS of 19 MPa.

The PLT results are shown in the attached Figure 3.1.

3.3 Global Stability Analysis

3.3.1 General

Limit state equilibrium stability analyses were carried out to evaluate the long-term global stability of the slope at each of the tower locations under static and pseudo-static conditions.

It has been assessed that negligible porewater pressure conditions are present in the ground around the tower position due the steepness of the terrain. Therefore, the effects of porewater pressure have been omitted from the slope stability analyses.

The analysis was carried out deterministically using a two-dimensional limit equilibrium (LE) program Slide2 by RocScience. The Spencer and GLE (General Limit Equilibrium)/Morgenstern-Price methods were applied in the analysis. The GLE/Morgenstern-Price and Spencer methods are referred to as rigorous LE methods because they analyse both force and moment equilibrium in the computation. They are recommended methods for practical slope stability analysis. The Cuckoo Search option for non-circular surfaces was used in the analyses to search for critical failure mechanisms.

3.3.2 Model Parameters

The rock mass was modelled utilizing the Generalized Hoek-Brown (2002) criterion and Rocscience program RSDData as presented in Table 3-1 below.

Table 3-1 Hoek-Brown Criterion Input Parameters

Rock Type	UCS (MPa)	GSI	Mi Curve Fitting Parameter	Unit Weight (kN/m ³)
Shale	19	50	6	25

3.3.3 Results

Based on the limit state equilibrium analysis, the slope at each of the tower locations are considered to be stable. The calculated FOS values are presented in Table 3-2 below. The results of the static and pseudo-static stability analyses for the tower locations are shown on the attached Figure 3.1 and Figure 3.2.

Table 3-2 Results of Limit Equilibrium Stability Analysis

Location	Minimum Calculated Factor of Safety	
	Static	Pseudo-Static
Proposed Tower Location	2.05	1.91
Proposed Alternate Tower Location	1.91	1.81

4. Design of RACS Tower Foundations

4.1 Design Criteria

The Wyssen RACS towers are typically supported by four vertical micro-piles and one inclined shear relief anchor. For the design of the tower foundation elements, the following design references were utilized:

- Canadian Foundation Engineering Manual, 4th Edition
- CSA S6:19, Canadian Highway Bridge Design Code (CHBDC), 2019.
- BC MoTI Volume 1 – Supplement to CHBDC S6:19, 2022.
- BC MoTI Standard Specifications for Highway Construction 2020.
- FHWA-IF-99-015, Ground Anchor and Anchored Systems, Geotechnical Engineering Circular No.4, June 1999.
- PTI DC35.1-14, Recommendations for Pre-stressed Rock and Soil Anchors, 2014.

The tower foundation is designed as a pile cap whereby applied forces are transferred to the underlying strata through the micro-piles and shear relief anchor. Therefore, bearing resistance, overturning, sliding of the base and erosion potential consequences are not considered as would be for shallow foundations, as any contribution arising from direct bearing of the pile cap on the ground shall be neglected.

4.2 Tower Foundation Design Loads

The foundation design loads for RACS tower at Panther as provided by Wyssen are summarized in Table 4-1 below. The tower is supported by four micro-piles and one shear relief anchor.

Table 4-1 Design Loads for Panther RACS Tower

Avalanche Velocity (m/s)	Mast Height (m)	Foundation Design Loads (kN) ¹	
		Micro-Piles ²	Shear Relief Anchor
18	12	146	312

¹ Factored Loads as provided by Wyssen. ² Load is given per pile.

The loads received from Wyssen as provided in Table 4-1 are factored and based on the following:

- Avalanche impact.
- Weight of the tower including deployment box weight.
- Snow creep.
- Wind load.

4.3 RACS Tower Foundation Design

4.3.1 General

The required bond lengths for the micro-piles and shear relief anchor are calculated based on published typical average ultimate bond strengths between rock and grout as found in Table C6.1 from Recommendations for Prestressed Rock and Soil Anchors (Post-Tensioning Institute (PTI) DC35.1-14, 2014) and Foundations on Rock (Wyllie, 1999).

An approximate relationship between the rock-grout bond strength and the UCS of the rock as been developed from the results of load tests in a wide range of rock types and strengths.

The working bond strength is related to the UCS of the rock according to the following:

$$\tau_a \approx \frac{\sigma_{u(r)}}{30} \quad \text{up to a maximum value of 1.4 MPa (Wyllie, 1999)}$$

where: τ_a = working bond strength of the rock-grout interface

$\sigma_{u(r)}$ = uniaxial compressive strength of the rock in the bond zone

Therefore, using a bond strength of 0.63 MPa, the calculated minimum bond length for the threadbar micro-piles and shear relief anchors in competent rock for drill hole diameters of 63.5 mm and 76 mm respectively based on the design loads provided in Table 4-1 is summarized in Table 4-2 below.

Table 4-2 Minimum Bond Length

Avalanche Velocity (m/s)	Mast Height (m)	Minimum Calculated Bond Length (m)	
		Micro-Piles ¹	Shear Relief Anchor ²
18	12	2.31	4.13

¹ Micro-pile has a minimum drill hole diameter of 63.5 mm. ² Shear Relief Anchor has a minimum drill hole diameter of 76 mm.

The bond lengths were calculated according to the following formula (PTI, 2014):

$$L_b = \frac{P \cdot FS}{\pi \cdot d \cdot \tau_u}$$

where: L_b = bond length

P = design load of anchor

d = diameter of drill hole

τ_u = average ultimate bond strength along interface between grout and ground

FS = factor of safety on average ultimate bond strength

The PTI (2014) Recommendations for Prestressed Rock and Soil Anchors document requires that a minimum bond length of 3.0 m be required for anchors.

4.3.2 Services Life Calculations

4.3.2.1 Design Criteria and Material Standards

The design criteria for the tower foundations, is based on a design service life of 75 years. The following material standards apply to the use of steel manufactured products in North America:

- CAN/CSA G164. “Hot Dip Galvanizing of Irregularly Shaped Articles”.
- CAN/CSA G30.18. “Carbon Steel Bars for Concrete Reinforcement”.
- CAN/CSA G40.21. “Structural Quality Steels”.

4.3.2.2 Tower Foundation Minimum Threaded Bar Size

The post threaded bar micro piles and anchors, and all associated components (i.e., bearing plates, nuts, washers) shall be hot dip galvanized as per CAN/CSA G164. Minimum thread bar sizes required for the tower foundations based on the design loads provided in Table 4-1 and zinc coating and sacrificial thickness calculations conducted based on NCHRP Report 675 (2011), as provided in Appendix C, indicate that the selected thread bars meet the 75-year service life requirements. Minimum threadbar sizes for RACS tower foundations are summarized in Table 4-3 below.

Table 4-3 Minimum Threadbar Size

Avalanche Velocity (m/s)	Mast Height (m)	Minimum Calculated Threadbar Diameter (mm)	
		Micro-Piles	Shear Relief Anchor
18	12	32	43

4.3.3 Frost Penetration

Frost susceptibility of earth material refers to the propensity of the ground to grow ice lenses and heave during freeze and thaw cycles and is related to the size distribution of soil particles (CFEM, 2006).

The tower foundations have been designed so that any length of micro-pile or shear relief anchor contributing to supporting the RACS tower is beneath the maximum seasonal frost penetration depth.

Based on a Freezing Index of approximately 675 degree-days below 0°C as calculated from weather station Albert Canyon Station (Station Code: 38227) data between 1999 to 2022, frost depth is estimated utilizing Modified Berggen equation (CFEM 2006). The frost penetration depth is estimated (from normal freezing index) at 1.4 m below ground surface. Therefore, the bonded length of the micro-piles and anchors will start below a depth of 1.43 m.

It is important to note that the construction schedule plays an important role in the short and long-term performance of proposed pavement, foundations, and slabs. Should the construction of any structure be planned to take place over winter, Ecora shall be contacted to review and confirm that the winter-related design concerns (i.e., frost heave of subgrade) are addressed.

4.3.4 RACS Tower Foundation Design Summary

The foundation design summary for RACS tower at Panther is provided in Table 4-4 below.

Table 4-4 RACS Tower Foundation Design Summary

Length (m)	Micro-Piles	Shear Relief Anchor
Minimum Required Bond Length Calculated (m)	2.31	4.13

Frost Penetration (m)	1.4	1.4
Calculated Embedment Length Required (m)	3.71	5.53
Total Recommended Embedment Length (m)	4	6

It is assumed that the ground's ability to provide resistance starts only below the depth of frost penetration. Therefore, the *Calculated Embedment Length Required* = *Frost Penetration* + *Minimum Calculated Embedment Length Calculated*.

The design drawings (Issued for Tender) are attached in Appendix A.

5. Construction Considerations

5.1 Accessibility

The site is accessible using a temporary helicopter landing pad located approximately 30 m W of the proposed rope access point.

5.2 Rock Scaling

Rock scaling may have to be undertaken during construction of the RACS. Rock scaling would create a hazard at the TCH, and temporary rock fall protection work and limited road closures may be required during the execution of the rock scaling works.

Furthermore, temporary rockfall protection measures may be required during construction.

5.3 Tree Felling

In order to ensure effective blast wave propagation, trees in the immediate area of the proposed tower may have to be removed. Tree felling would create a hazard at the TCH limited and road closures may be required during the execution of the tree felling works.

5.4 Quality Control Procedures

The EoR and contractor are responsible for foundation design and construction. Concrete strength, type, rebar spacing, bond length and bar size have been determined by EoR as specified on Drawings (see Appendix A) using standard quality control guidelines. The following aspects in particular must be inspected:

- Micro-pile/anchor location & orientation.
- Micro-pile/anchor hole diameter & length.
- Confirm nominal (design) embedment into competent rock.
- Confirm correct threadbar size, grade & length.
- Check threadbar for loss of galvanization coating.
- Confirm grout preparation is in accordance with specification.
- Cast one set of grout cubes per tower location to verify strength.
- Proof test one shear relief anchor per tower location.

- Confirm correct reinforcing bar size, orientation & spacing for levelling pad.
- Cast one set of concrete cylinders per tower location to verify strength.
- Verification test one sacrificial micro-pile per tower location.
- Confirm exposed threadbar, washer and nut galvanized.

6. Closure

We trust this report meets your requirements. Please contact our office if you have any questions or comments concerning this report.



References

- American Society of Civil Engineers (ASCE), 2001. "Design and Construction of Frost-Protected Shallow Foundations".
- British Columbia Ministry of Transportation and Infrastructure (BC MoTI), 2022. "Bridge Standards and Procedures Manual, Supplement to CHBDC S6-19".
- British Columbia Ministry of Transportation and Infrastructure (BC MoTI), 2015. "Columbias Program Snow Avalanche Atlas".
- British Columbia Ministry of Transportation and Infrastructure (BC MoTI), 2020. "Standard Specifications for Highway Construction".
- Canadian Geotechnical Society, 2006. "Canadian Foundation Engineering Manual, 4th Edition".
- CSA Group, 2019. "Canadian Highway Bridge Design Code", CSA S6-19.
- Cui, Y., Fortin, G., Meredith-Jones, S., Zhao, S., and Jones, L.D., 2017a. MapPlace 2 (beta) Workshop. British Columbia Ministry of Energy and Mines, British Columbia Geological Survey Information Circular 2017-3, 89 p.
- DataBC Program, 2015. iMapBC (<https://maps.gov.bc.ca/ess/hm/imap4m/>), accessed January, 2023.
- Ecora Engineering and Resource Group (Ecora), 2023. "Revelstoke Remote Avalanche Control Systems (RACS), Site Reconnaissance Report", Project number 201740-04.
- Ecora Engineering and Resource Group (Ecora), 2023. "Revelstoke Remote Avalanche Control Systems (RACS), Desktop Assessment Panther (Path No. 48)", Project number 201740-04.
- Kolaj, M., Halchuk, S., Adams, J., and Allen, T.I., (2020). "Trial Sixth Generation seismic-hazard model of Canada: seismic-hazard values for selected localities", Geological Survey of Canada, Open File 8629, 1 .zip file. (<https://doi.org/10.4095/321473>).
- National Research Council of Canada (NRCC), 2020. "National Building Code of Canada:2020".
- Post-Tensioning Institute (PTI), 2014. "Recommendations for Prestressed Rock and Soil Anchors".
- Province of British Columbia, 2018. "BC Building Code (BCBC)".
- Read, J., Stacey, P. 2009. "Guidelines for Open Pit Slope Design". Collingwood, Vic: CSIRO Publishing.
- Resources Inventory Committee (RISC), 1996. "Guidelines and Standards to Terrain Mapping in British Columbia", Surficial Geology Task Group, Earth Sciences Task Force British Columbia.
- Thompson, R.I., 2004. "Geology, Revelstoke, British Columbia", Geological Survey of Canada, Open File 4385.
- U.S. Department of Transportation, Federal Highway Administration (FHWA), 1999. "Geotechnical Engineering Circular No. 4, Ground Anchors and Anchored Systems", FHWA-IF-99-015.
- Wyllie, D. C. 2018. "Rock Slope Engineering. Civil Applications. Fifth Edition". CRC Press. Taylor and Francis.

Figures

- Figure 3.1 Point Load Test Results.
- Figure 3.2 Stability Analysis Proposed Site.
- Figure 3.3 Stability Analysis Proposed Alternate Site.

Client:	BC MoTI	Project No:	201740-04	Date:	12-Jul-23
Project:	Revelstoke RACS Panther	Borehole/Test Pit No:	N/A	Tested By:	S. Kraetzer
Location:	Revelstoke, BC	Borehole/Pit Location:	N/A	Checked By:	D. J. Kruger, MEng

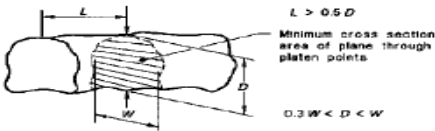
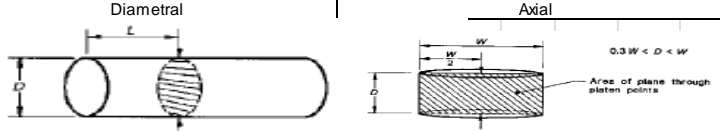
Depth (m)	Sample Number	Rock Description (Including nature and orientation of any defects or planes of weakness)	Moisture Condition	Dimetral					Axial / Irregular Lump						Calculated UCS (MPa)	Photo of Failed Sample	
				L (mm)	D (mm)	P (kN)	I _s (MPa)	I _{s(50)} (MPa)	W (mm)	D (mm)	D ² _o (mm ²)	P (kN)	I _s (MPa)	K _{PLT} (mm)			I _{s(50)} (MPa)
N/A	P1	Metasedimentary	Air Dry	-	-	-	-	-	80	55	5602	1.940	0.35	1.20	0.42	5	
N/A	P2	Metasedimentary	Air Dry	-	-	-	-	-	60	55	4202	6.522	1.55	1.12	1.74	23	
N/A	P3	Metasedimentary	Air Dry	-	-	-	-	-	85	46	4978	9.852	1.98	7.93	15.69	30	
Shape of Specimen		Cylinder Core															
Direction of Loading		Dimetral					Axial					 <p>$L > 0.5D$ Minimum cross section area of plane through platen points $0.3W < D < W$</p>					
Required Shape Proportions of Test Specimens		 <p>Area of plane through platen points $0.3W < D < W$</p>															

Notes:

Revelstoke RACS Foundation Design Report Panther (Path No. 48)

Point Load Test Results

Project No. 201740-04
 Client: BC Ministry of Transportation and Infrastructure
 Office: Kelowna
 Scale: NTS
 Date: JULY 11, 2023
 DWN: DJK CHK: MJL Scale: NTS

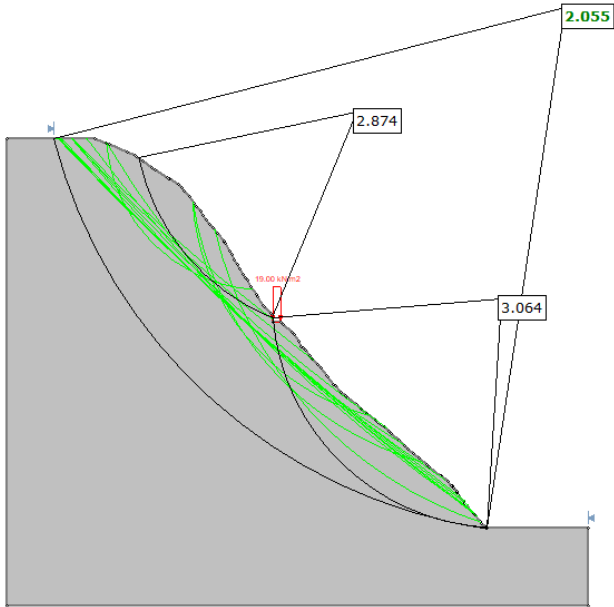

Material Name	Color	Unit Weight (kN/m ³)	Strength Type	UCS (intact) (kPa)	Parameters vary with depth	GSI	mi	D	Water Surface	Ru Value
Material 1	Grey	25	Generalized Hoek-Brown	19000	No	50	6	0.7	None	0

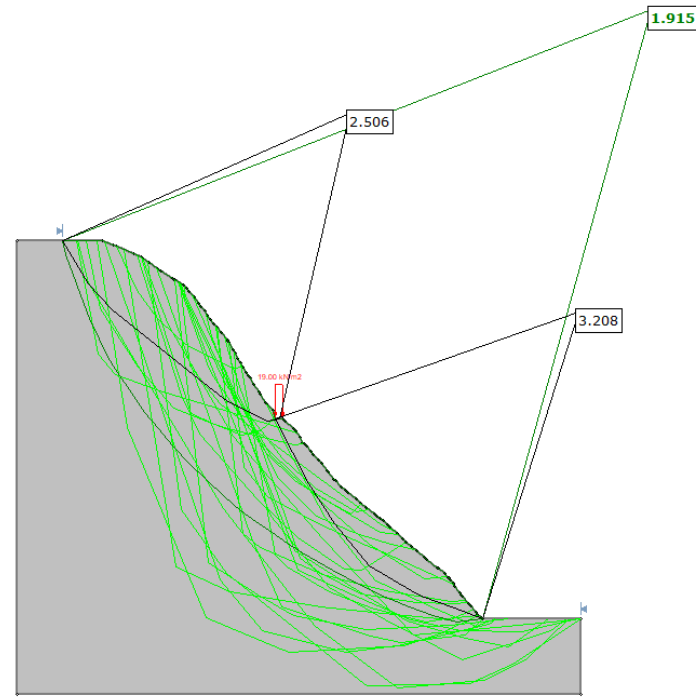

Material Name	Color	Unit Weight (kN/m ³)	Strength Type	UCS (intact) (kPa)	Parameters vary with depth	GSI	mi	D	Water Surface	Ru Value
Material 1	Grey	25	Generalized Hoek-Brown	19000	No	50	6	0.7	None	0

Revelstoke RACS Foundation Design Report Panther (Path No. 48)

Stability Analysis Proposed Tower Location

Project No. 201740-04
 Client: BC Ministry of Transportation and Infrastructure
 Office: Kelowna
 Scale: NTS
 Date: JULY 21, 2023
 DWN: DJK CHK: MJL



Figure 3.2

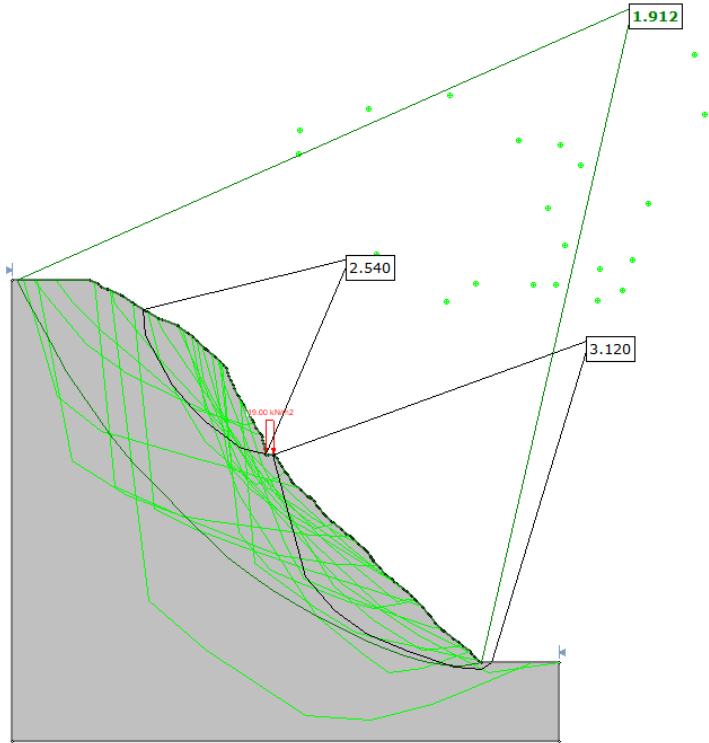

Material Name	Color	Unit Weight (kN/m ³)	Strength Type	UCS (intact) (kPa)	Parameters vary with depth	GSI	mi	D	Water Surface	Ru Value
Material 1		25	Generalized Hoek-Brown	19000	No	50	6	0.7	None	0

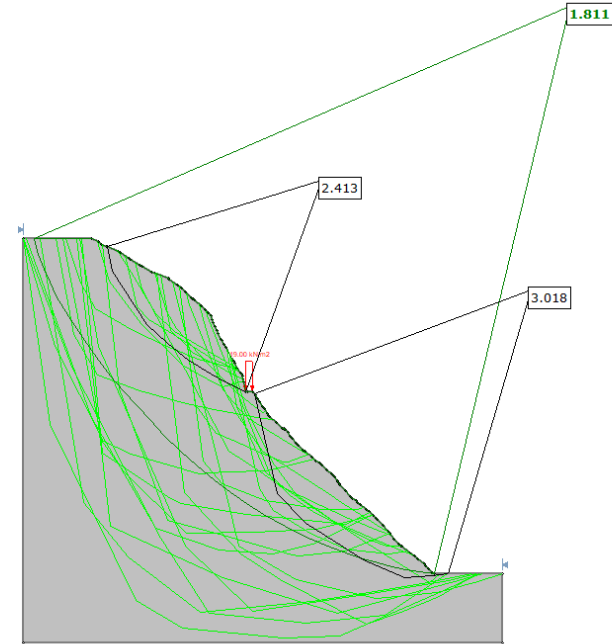

Material Name	Color	Unit Weight (kN/m ³)	Strength Type	UCS (intact) (kPa)	Parameters vary with depth	GSI	mi	D	Water Surface	Ru Value
Material 1		25	Generalized Hoek-Brown	19000	No	50	6	0.7	None	0

Revelstoke RACS Foundation Design Report Panther (Path No. 48)

Stability Analysis Proposed Alternate Tower Location

Project No. 201740-04
 Client: BC Ministry of Transportation and Infrastructure
 Office: Kelowna
 Scale: NTS
 Date: JULY 11, 2023
 DWN: DJK CHK: MJL



Figure 3.3

Photographs

Photo 1 Panther overview.

Photo 2 Proposed Tower Locations and Helicopter Explosive Drop Placement Targets.

Photo 3 Preferred Tower Location on Rock Ledge.

Photo 4 Rock Mass Immediately Upslope of Preferred Tower Location.

Photo 5 Panther Helicopter Landing Pad.

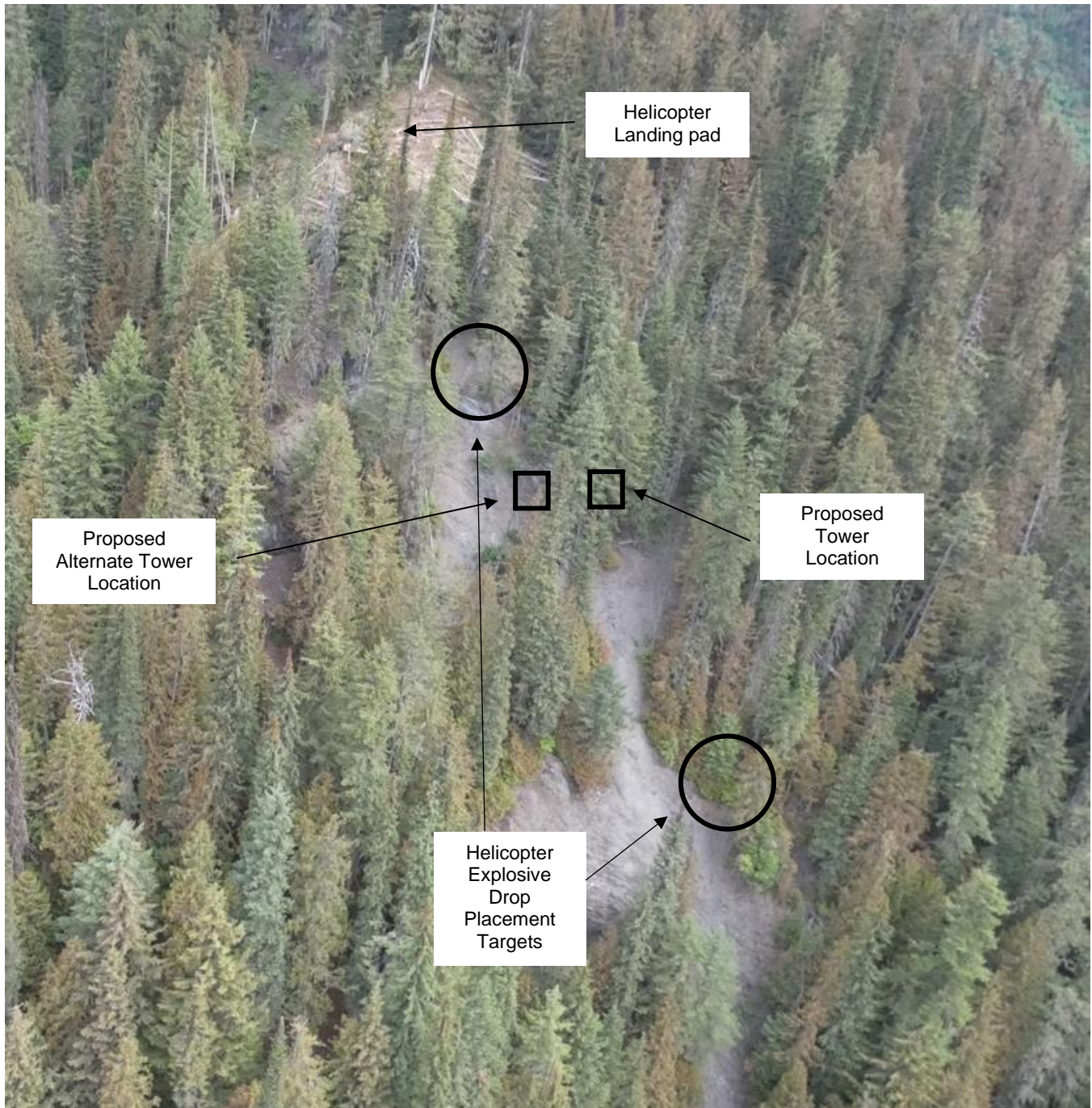

Photo 1 Panther Overview and Proposed Tower Locations and Helicopter Explosive Drop Placement Targets.

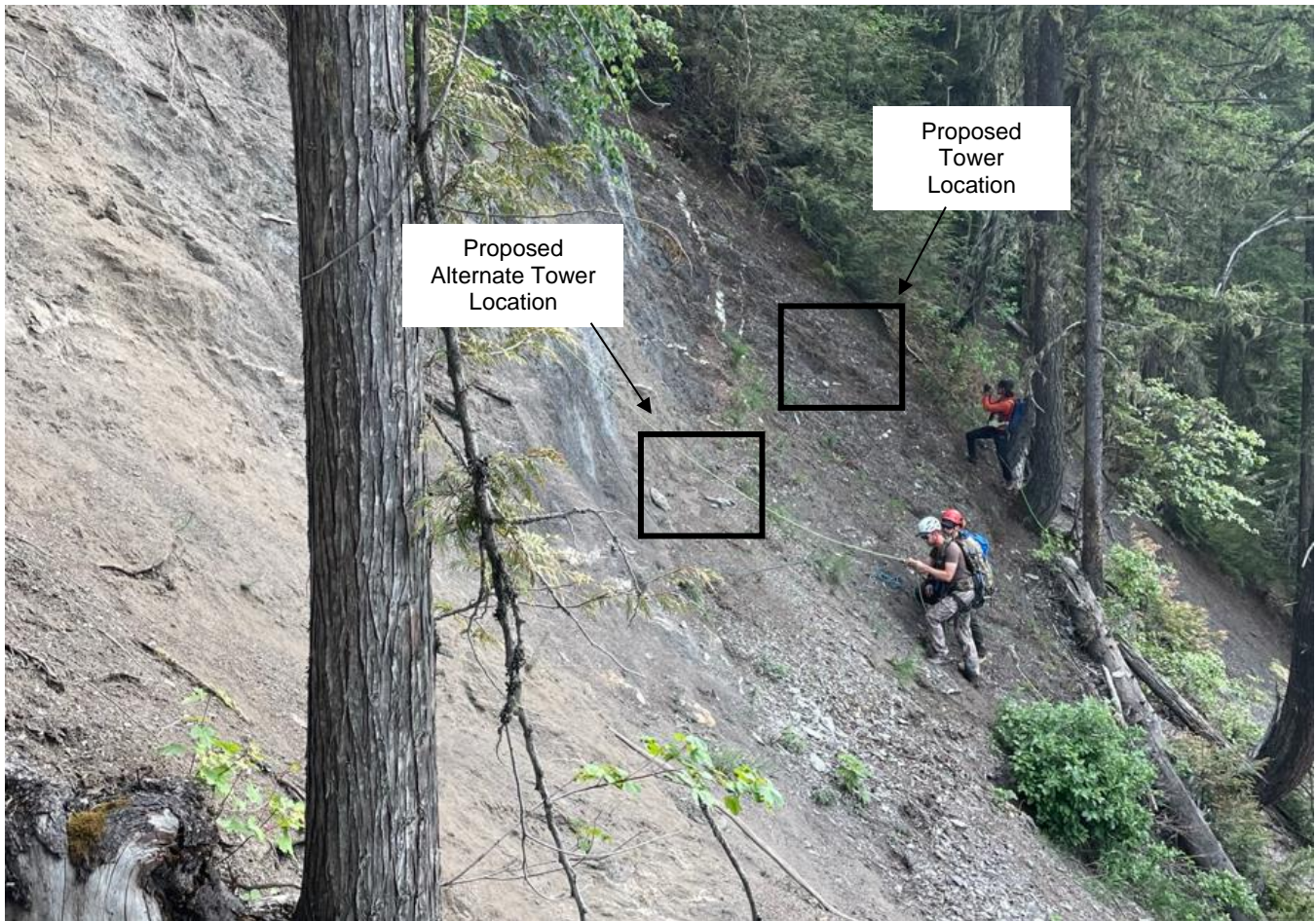

Photo 2

Preferred Tower Location on Rock Ledge.



Photo 3 **Rock Mass Structure at Proposed Tower Location.**



Photo 4

Panther Helicopter Landing Pad.

Appendix A

Design Drawings



Ministry of
Transportation
and Infrastructure



PROJECT No. 26265-0000

REMOTE AVALANCHE CONTROL SYSTEMS INSTALLATION

PANTHER (PATH NO. 48)

&

VICTOR LAKE (PATH NO. 14.4)

AUGUST 4, 2023

PLOTTED: 2023/08/04 11:54 AM BY: Tonia Edmonds

Z:\2020\geotech\201740-04_PANTHER SHEETS - 11x17.dwg 2023/08/04 11:51 AM LAYOUT: 100 USER: edmonds

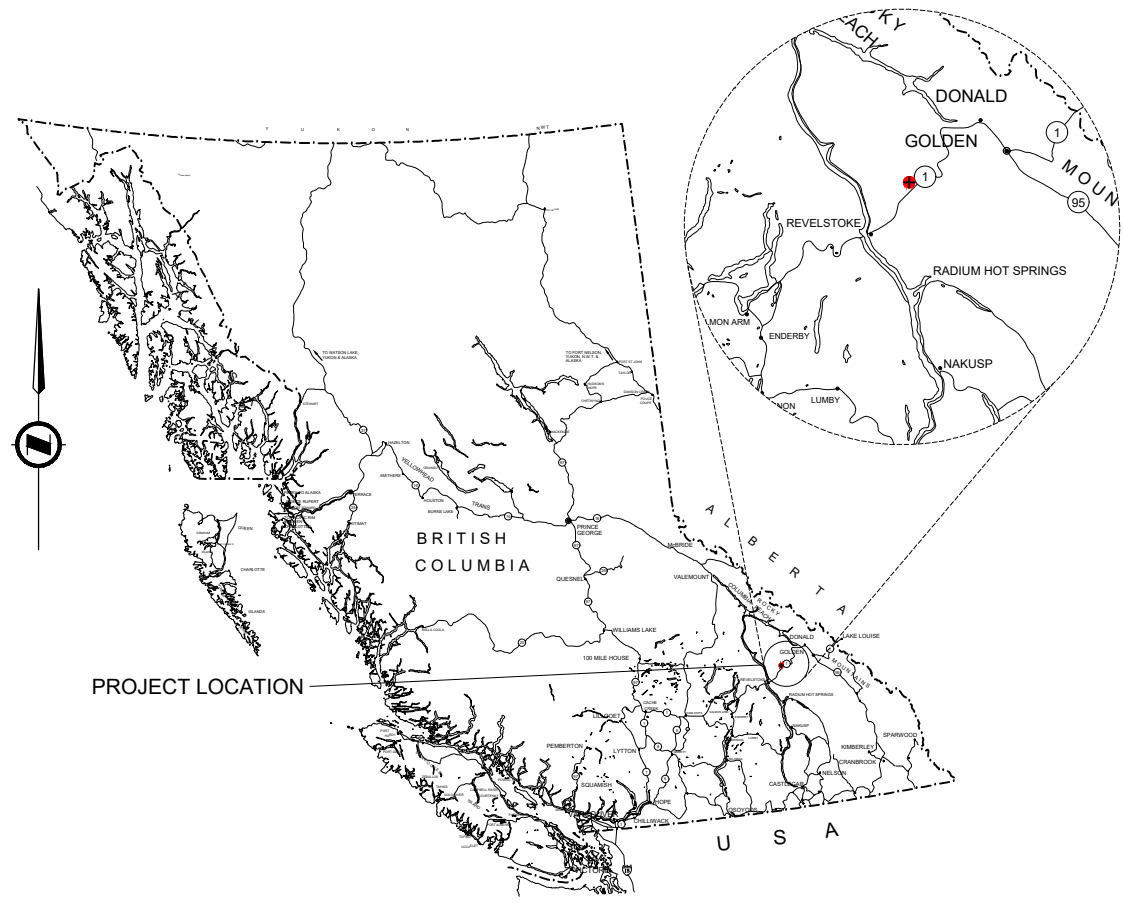

LOCATION PLAN
N.T.S

DRAWING INDEX	
DRAWING NO.	DRAWING TITLE
R2-1234-100	LOCATION & KEY PLAN - PANTHER
R2-1234-101	SITE PLAN - PANTHER
R2-1234-102	TOWER FOUNDATION DESIGN DETAILS - PANTHER
R2-1234-103	GEOTECHNICAL CONSTRUCTION NOTES - PANTHER
R2-1234-104	STRUCTURAL CONSTRUCTION NOTES - PANTHER

REFER TO TENDER DRAWING PACKAGE APPROVAL FORM
EXECUTIVE REGIONAL DIRECTOR

DATE:

REFER TO TENDER DRAWING PACKAGE APPROVAL FORM
DIRECTOR OF ENGINEERING

DATE:

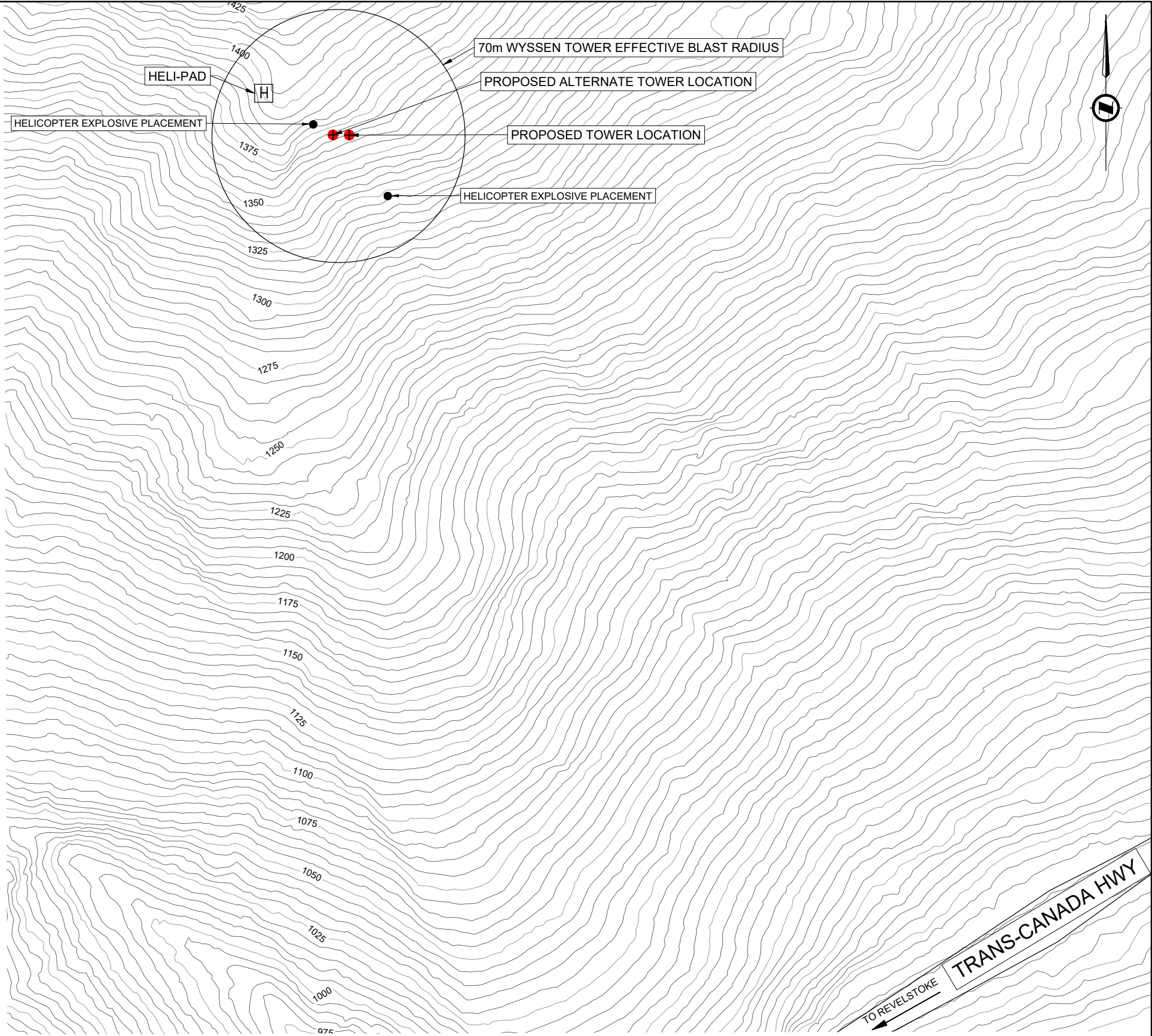

KEY PLAN

0 1:1250 50m

TO REVELSTOKE
TRANS-CANADA HWY

GENERAL NOTES:
1. Digital base plan provided by the Ministry of Transportation and Infrastructure. 5.0 m minor & 25.0 m major contour intervals.
2. Proposed RACS tower locations by Ecora Engineering & Resource Group Ltd. The locations shown are approximate only and will be field fit and approved by the ministry representative.

Drawing uses UTM Zone11 NAD83 Horizontal Datum, Vertical Datum CGVD28

PROPOSED RACS TOWER LOCATIONS			
PROPOSED TOWER	FOUNDATION LOCATION	ELEVATION	
MAIN	447770 E 5673148 N	1368 m	
ALTERNATE	447761 E 5673148 N	1365 m	

REV	DATE	REVISIONS	SIGNATURE
0	2023/08/04	ISSUED FOR TENDER	

PROFESSIONAL SEAL

DRAWN BY: T. EDMONDS DATE: 2023-07-21
DESIGNED BY: D. KRUGER & M. ROCHE DATE: 2023-07-21
REVIEWED BY: M. LAWS DATE: 2023-08-04
CAD FILENAME: 201740-04
DATE: 2023-08-04

BRITISH COLUMBIA MINISTRY OF TRANSPORTATION AND INFRASTRUCTURE SOUTHERN INTERIOR REGION

WYSSEN avalanche control

ecora
ECORA ENGINEERING & RESOURCE GROUP LTD.
2045 ENTERPRISE WAY, KELOWNA, BC V1Y 9T5
Phone: 250-469-9757 www.ecora.ca

LOCATION & KEY PLAN - PANTHER				
REMOTE AVALANCHE CONTROL SYSTEMS INSTALLATION PANTHER (PATH NO. 48)				
FILE NUMBER	PROJECT NUMBER	REG	DRAWING NUMBER	REV
-	26265-0000	-	R2-1234-100	0

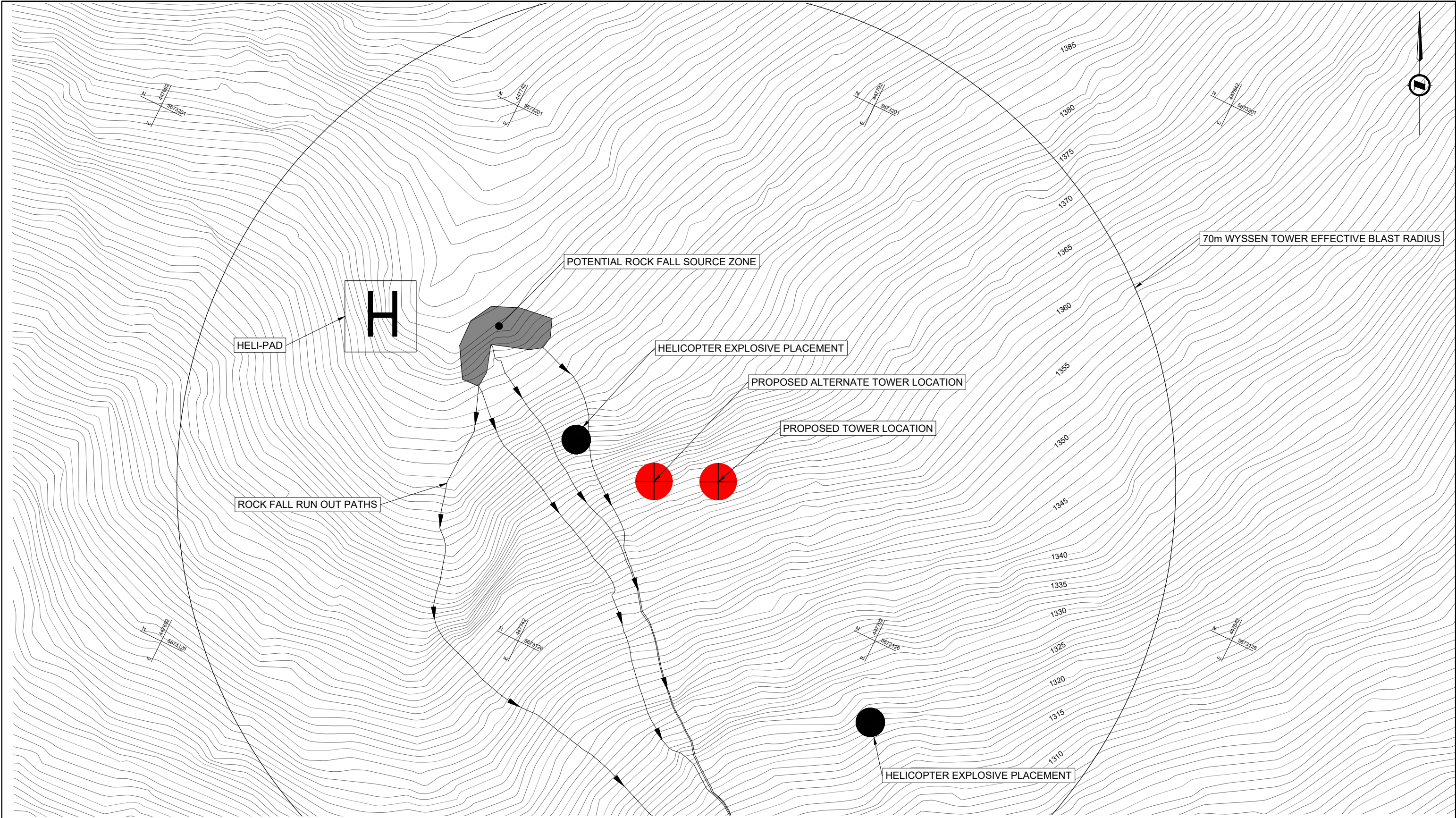

PLAN

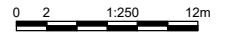

GENERAL NOTES:

- Digital base plan provided by the Ministry of Transportation and Infrastructure. 1.0 m minor & 5.0 m major contour intervals.
- Proposed RACS tower locations by Ecora Engineering & Resource Group Ltd. The locations shown are approximate only and will be field fit and approved by the ministry representative.

Drawing uses UTM Zone11 NAD83 Horizontal Datum, Vertical Datum CGVD28

PROPOSED RACS TOWER LOCATIONS		
PROPOSED TOWER	FOUNDATION LOCATION	ELEVATION
MAIN	447770 E 5673148 N	1368 m
ALTERNATE	447761 E 5673148 N	1365 m

REV	DATE	REVISIONS	SIGNATURE
0	2023/08/04	ISSUED FOR TENDER	

SIGNATURE	PROFESSIONAL SEAL

DRAWN BY	T. EDMONDS	DATE	2023-07-21
DESIGNED BY	D. KRUGER & M. ROCHE	DATE	2023-07-21
REVIEWED BY	M. LAWS	DATE	2023-08-04
CAD FILENAME	201740-04	DATE	2023-08-04

BRITISH COLUMBIA MINISTRY OF TRANSPORTATION AND INFRASTRUCTURE SOUTHERN INTERIOR REGION

WYSSSEN avalanche control **ecora**

ECORA ENGINEERING & RESOURCE GROUP LTD.
2045 ENTERPRISE WAY, KELOWNA, BC V1Y 9T5
Phone: 250-469-9757 www.ecora.ca

SITE PLAN - PANTHER				
REMOTE AVALANCHE CONTROL SYSTEMS INSTALLATION PANTHER (PATH NO. 48)				
FILE NUMBER	PROJECT NUMBER	REG	DRAWING NUMBER	REV
-	26265-0000	-	R2-1234-101	0

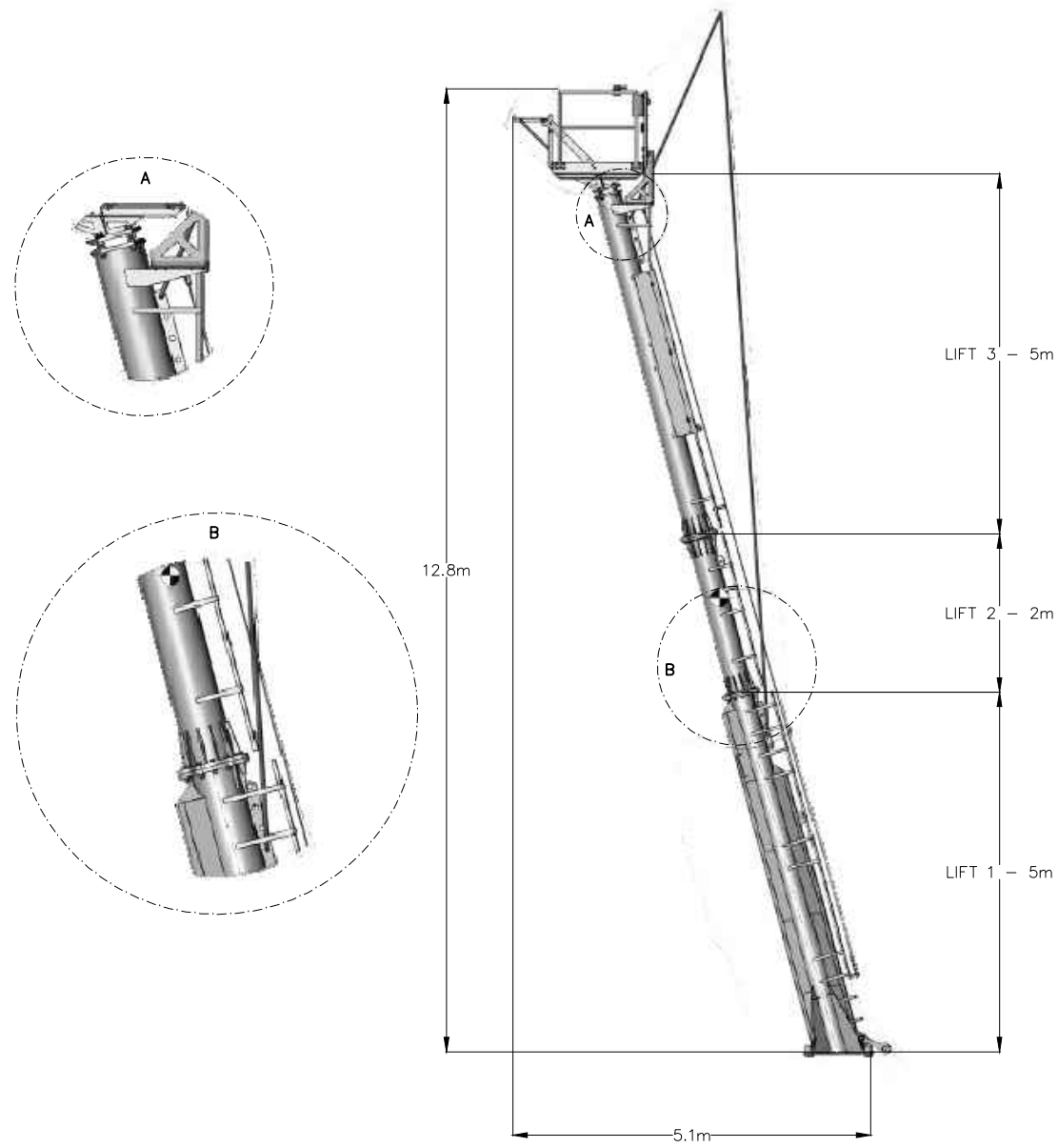

AVALANCHE TOWER (12m HIGH) SIDE VIEW

SCALE 0 0.5 1:50 2.5m

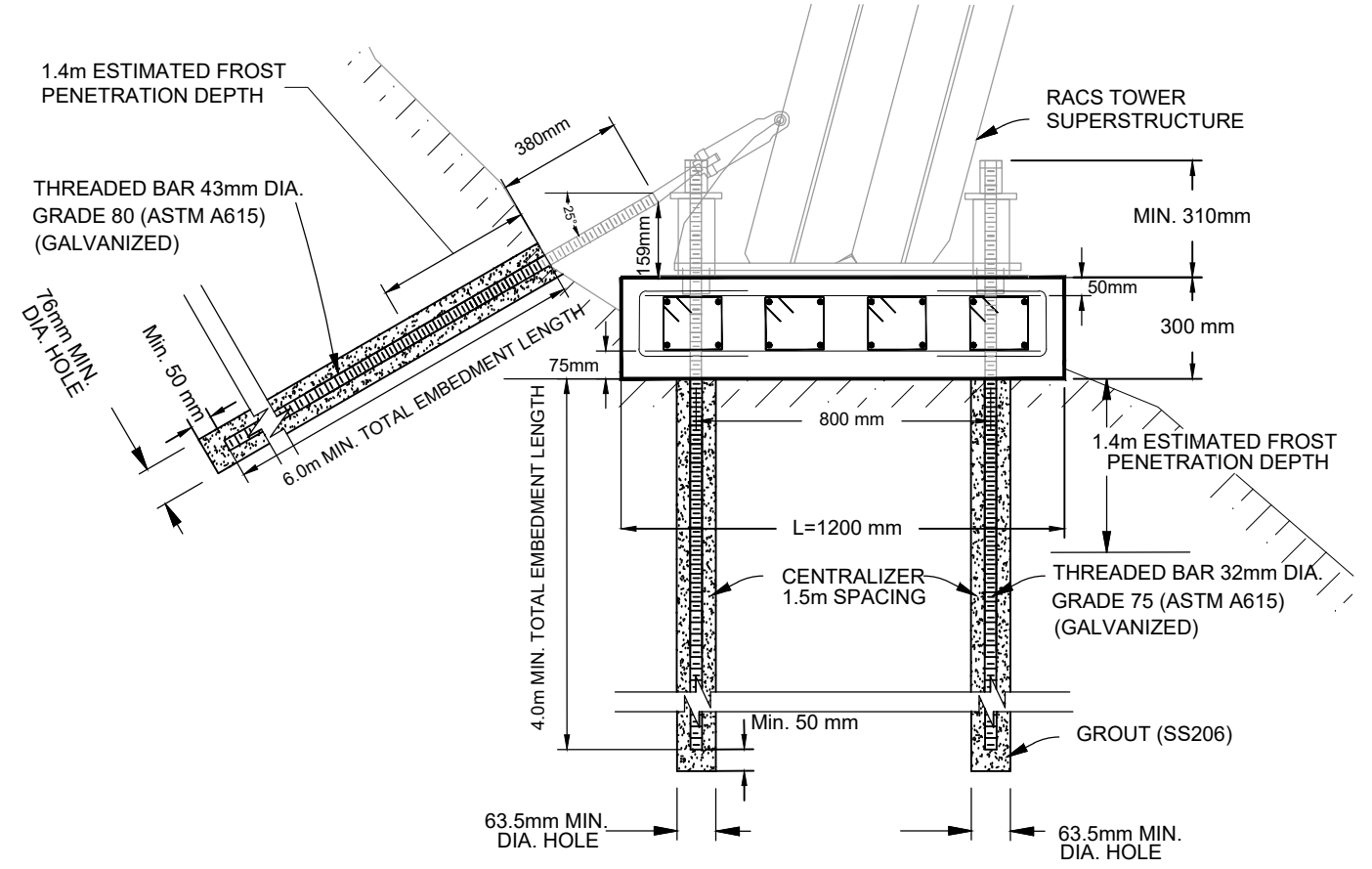

TOWER FOUNDATION MICROPILE/SHEAR RELIEF ANCHOR DETAILS

SCALE 0 0.1 1:10 0.5m

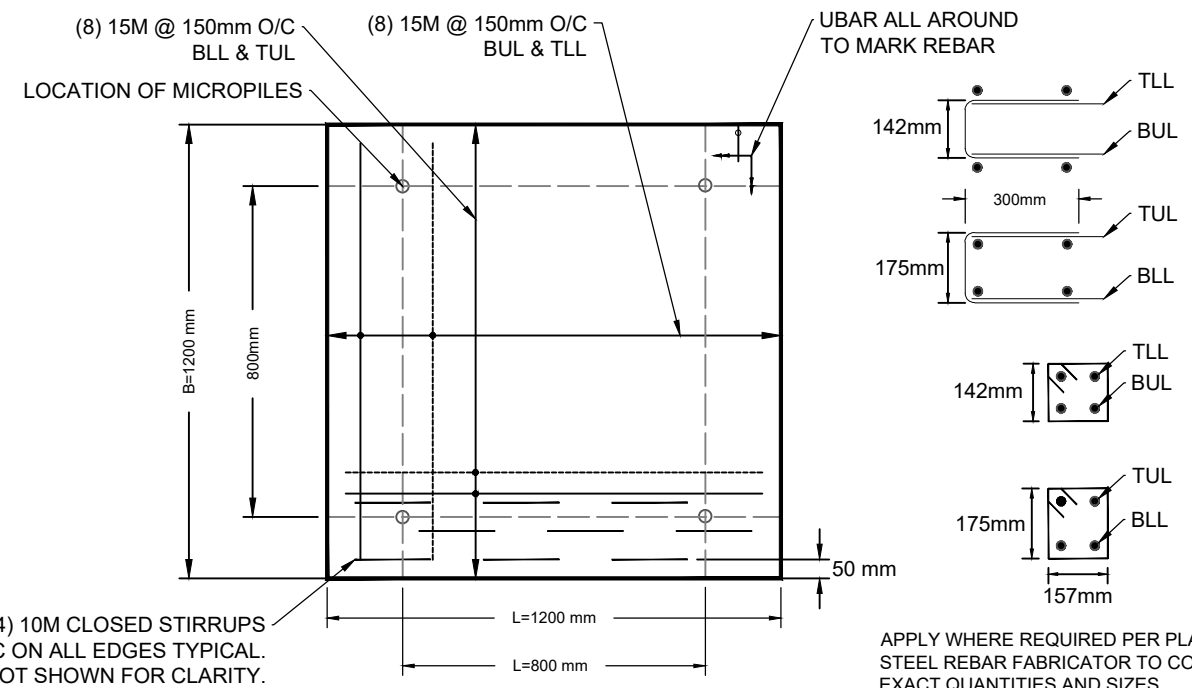

3 ROWS OF (4) 10M CLOSED STIRRUPS @ 75mm O/C ON ALL EDGES TYPICAL. NOT SHOWN FOR CLARITY.

APPLY WHERE REQUIRED PER PLAN. STEEL REBAR FABRICATOR TO CONFIRM EXACT QUANTITIES AND SIZES.

TOWER FOUNDATION DETAIL (FOR ROCK)

SCALE 0 0.1 1:10 0.5m

THE CONTRACTOR SHALL BE RESPONSIBLE FOR THE CONSTRUCTION SEQUENCE OF TOWER ERECTION AND INSTALLATION AS PER MANUFACTURERS SPECIFICATIONS. ALL TEMPORARY WORKS REQUIRED FOR TOWER ERECTION SHALL BE SIGNED AND SEALED BY AN ENGINEER LICENSED TO PRACTICE IN BRITISH COLUMBIA AND EXPERIENCED WITH DESIGN OF TEMPORARY WORKS SIMILAR TO TEMPORARY WORKS REQUIRED FOR THIS PROJECT.

REV	DATE	REVISIONS	SIGNATURE	PROFESSIONAL SEAL
0	2023/08/04	ISSUED FOR TENDER		

PROFESSIONAL SEAL

DRAWN BY: T. EDMONDS DATE: 2023-08-02
 DESIGNED BY: D. KRUGER & M. ROCHE DATE: 2023-07-21
 REVIEWED BY: M. LAWS DATE: 2023-08-04
 CAD FILENAME: 201740-04
 DATE: 2023-08-04

BRITISH COLUMBIA
 MINISTRY OF TRANSPORTATION AND INFRASTRUCTURE
 SOUTHERN INTERIOR REGION

WYSSSEN avalanche control
 ecora
 ECORA ENGINEERING & RESOURCE GROUP LTD.
 579 LAWRENCE AVE. KELOWNA, B.C. V1Y 6L8
 Phone: 250-489-9757 www.ecora.ca

TOWER FOUNDATION DESIGN DETAILS - PANTHER

REMOTE AVALANCHE CONTROL SYSTEMS INSTALLATION
 PANTHER (PATH NO. 48)

FILE NUMBER	PROJECT NUMBER	REG	DRAWING NUMBER	REV
-	26265-0000	-	R2-1234-102	0

1. GENERAL

- 1.1. The scope of work is outlined by these general notes as defined below for the Revelstoke Remote Avalanche Control System (RACS) - Panther (path no.48) Tower Foundation
- 1.2. All materials, workmanship and construction shall be in accordance with the drawings and the project specifications.
- 1.3. The Contractor is responsible for field locating all utilities and temporary rockfall protection.

2. MICRO-PILES AND SHEAR RELIEF ANCHORS

- 2.1. Tower foundation micro-piles and shear relief anchors shall consist of 32 mm and 43 mm Double Corrosion Protection (DCP) threaded bars. The threaded bars shall be Steel Hot Rolled Grade 517 MPa (Fy) and 552 MPa (Fy) respectively meeting ASTM A615/A615M.
- 2.2. Steel materials shall be hot-dip galvanized conforming to ASTM A123. All grout and steel materials shall be products of established manufacturers regularly engaged in the manufacture of rock anchor and micro-pile materials for at least five years.
- 2.3. Threaded bars shall be new, straight, undamaged continuous without splices or welds. Cut-thread reinforcing bars not permitted. The threaded bars should not be subjected to the heat of torch or welding. Field cutting should be done with an abrasive wheel or band saw.
- 2.4. All micro-piles and shear relief anchors shall be carefully handled and shall be stored on supports to keep the steel from contact with the ground. Damage to the shear relief anchors or micro-piles as a result of overstressing, abrasion, cuts, nicks, welds and weld splatter shall be cause of rejection by the ministries representative. Shear relief anchors and micro-piles shall be protected from and sufficiently free of dirt, rust, and other deleterious substances prior to installation. Heavy corrosion or pitting of shear relief anchors shall be cause for rejection by the ministries representative. Cut-thread reinforcing bars are not permitted.
- 2.5. Shear relief anchor and micro-pile lengths shall be installed according to plans, as detailed.
- 2.6. Shear relief anchor and micro-pile drill hole diameters for the tower foundation shall be minimum of 76 mm and 63.5 mm respectively.
- 2.7. All nuts and couplers for Tower Foundation shall be manufactured by the manufacturer and be sized for a galvanized bar. Spherical nut or hex nut with steel beveled plate washers may be used to provide the correct angle.
- 2.8. All shear relief anchors and micro-piles must be installed with the PVC centralizers spaced no more than 1.5 m O.C. beginning no more than 1.0 m from the bottom of the shear relief anchor or micro-pile. Centralizers shall be scheduled 40 PVC and 10 mm smaller in outside diameter than the borehole diameter to allow free grout flow.

3. MICRO-PILES AND SHEAR RELIEF ANCHOR GROUT

- 3.1. The Contractor shall complete all micro-pile and shear relief anchor grout work in accordance with MoTI SS 206.11 and 206.31 unless otherwise modified by this clause.
- 3.2. Grout cubes shall be collected and tested for compressive strength, in accordance with CSA A23.2-1B. Three cubes shall be tested at 3 (minimum 3 days & 20 MPa), 7 (minimum 30 MPa), and 28 (minimum 40 MPa) days. One set of nine cubes shall be collected for each of the grout batches mixed for the anchor installation.

4. MICRO-PILES AND SHEAR RELIEF ANCHOR INSTALLATION

- 4.1. Micro-pile and shear relief anchor holes shall be installed without loss of ground, which may require casing in soils. Holes shall not be drilled with bentonite or water. As soon as the hole drilling is complete, clean Micro-pile and shear relief anchors with centralizers shall be placed in the hole, subsequently the hole shall be tremie grouted.
- 4.2. Acceptable Tolerances are as follows:
 - 4.2.1. Micro-pile and shear relief anchor position: Contractor shall use template to ensure proper shear relief anchor and micro-pile positioning with +/- 3mm horizontally.
 - 4.2.2. Micro-pile and shear relief anchor Length: No less than specified length.
 - 4.2.3. Micro-pile and shear relief anchor Inclination: +/- 2 degrees.

5. TOWER FOUNDATION DESIGN CONSIDERATIONS:

- 5.1. Excavate rock to provide a level base.
- 5.2. For pile caps thicker than 750 mm constructed of 15M rebar, a third 'mat' of rebar is required.
- 5.3. The additional 'mat' of rebar shall be placed within the cage near the center OR in the case of a rock 'step' additional stirrups are to be provided to encase the additional 'mat' of rebar.
- 5.4. Should the pile cap rock subgrade cross fall or step, the bottom mat is to 'loosely' follow the profile of the rock. There shall be no more than 200 mm from bottom of cage to surface of rock through difficult sections, and as close to 75 mm cover as possible through smoother sections.
- 5.5. An additional mat of rebar can be provided with stirrups or 'U' bars with laps as specified (600 mm for 15M)

LOAD SUMMARY		
STRUCTURE	FOUNDATION TYPE	DESIGN LOAD * (kN)
PANTHER SITE	VERTICAL MICROPILE	146
	SHEAR RELIEF ANCHOR	312

* The Design Loads are factored

Ultimate Bond Strength (BS) = 126.3 kN/m for 63.5 mm hole diameter (in rock).
151.2 kN/m for 76 mm hole diameter (in rock).

6. MICRO-PILES AND SHEAR RELIEF ANCHOR TESTING

The grout mixture used for the micro-pile and shear relief anchor tests need to have cured at least 72 hours or attained at least their specified 3-day compressive strength at the time of testing.

6.1. VERIFICATION TESTS:

- 6.1.1. A sacrificial verification test micro-pile shall be installed and tested at a location specified by the engineer.
- 6.1.2. Verification tests shall be performed according to the verification test load schedule below:

LOAD	HOLD TIME (MINUTES)
AL	1
0.13 VTL	10 - RECORDED AT 1,2,4,5 AND 10
0.25 VTL	10 - RECORDED AT 1,2,4,5 AND 10
0.38 VTL	10 - RECORDED AT 1,2,4,5 AND 10
0.50 VTL	10 - RECORDED AT 1,2,4,5 AND 10
0.63 VTL	10 - RECORDED AT 1,2,4,5 AND 10
0.75 VTL (CREEP TEST)	60 - RECORDED AT 1,2,4,5,6,10,20,30,50,60
0.88 VTL	10
1.00 VTL	10
AL	1

Verification Test Load (VTL) = Test Bond Length (TBL) x Bond Strength (BS)

Unbonded length = 2.0 m & Bonded Length = 1.0 m

- a. AL = alignment load (less than or equal to 0.025 VTL).
- b. Soil movement must be measured after each load increment has been achieved and at each time step.
- c. Permanent micro-pile movement must be recorded.

6.2. VERIFICATION TEST ACCEPTANCE CRITERIA

- 6.2.1. A verification test micro-pile shall be considered acceptable when all of the following criteria are met:
 - a. Total creep movement is less than 2 mm between the 6- and 60-minute readings and the creep rate is linear or decreasing through the creep test load hold period.
 - b. The total movement (δVTL) measured at 1.00 VTL exceeds 80 percent of the theoretical elastic elongation of the unbonded length of the test micro-pile.
 - c. Pullout does not occur before VTL. Pullout failure is defined as the inability to further increase the test load while there is continued pullout movement of the test micro-pile.

6.3. PROOF TESTS

- 6.3.1. A shear relief anchor proof test shall be undertaken at a location specified by the engineer.
- 6.3.2. Proof tests shall be performed according to the test load schedule below:

LOAD	HOLD TIME (MINUTES)
AL (0.05 DL MAXIMUM)	UNTIL STABLE
0.25 DL*	UNTIL STABLE
0.50 DL	UNTIL STABLE
0.75 DL	UNTIL STABLE
1.00 DL	UNTIL STABLE
1.25 DL	UNTIL STABLE
1.33 DL CREEP TEST	10**

* Design Load (DL) = Test Bond Length (TBL) x Bond Strength (BS)

** Creep Test, if the anchor moves more than 1mm during the 10-minute hold, maintain load for an additional 50 minutes.

Proof test shear relief anchor shall be fully grouted.

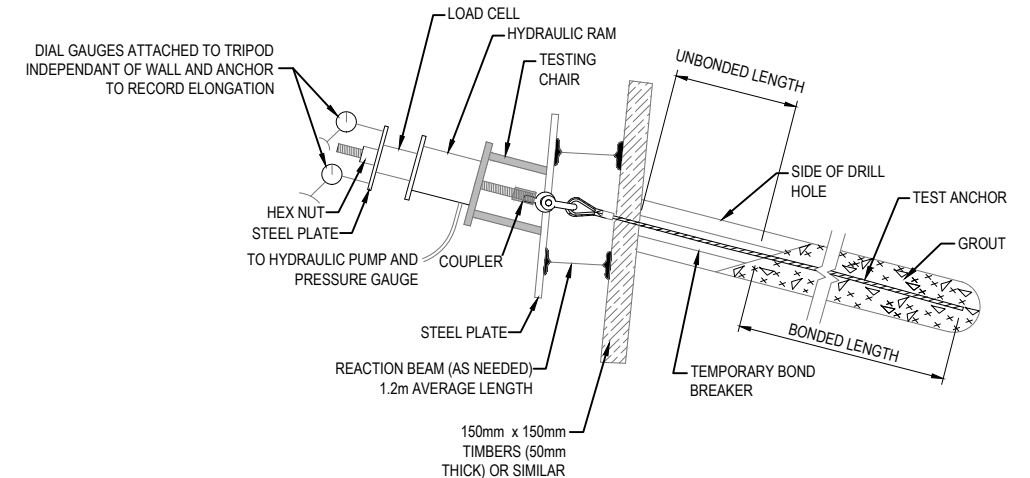

TEST APPARATUS SET-UP FOR VERIFICATION & PROOF TESTING

REV	DATE	REVISIONS	SIGNATURE
0	2023/08/04	ISSUED FOR TENDER	

PROFESSIONAL SEAL	

DRAWN BY	T. EDMONDS	DATE	2023-08-02
DESIGNED BY	D. KRUGER & M. ROCHE	DATE	2023-07-21
REVIEWED BY	M. LAWS	DATE	2023-08-04
CAD FILENAME	201740-04	DATE	2023-08-04

BRITISH COLUMBIA MINISTRY OF TRANSPORTATION AND INFRASTRUCTURE SOUTHERN INTERIOR REGION

WYSSSEN avalanche control

ecora

ECORA ENGINEERING & RESOURCE GROUP LTD. 579 LAWRENCE AVE. KELOWNIA, B.C. V1Y 6L8 Phone: 250-469-9757 www.ecora.ca

GEOTECHNICAL CONSTRUCTION NOTES - PANTHER				
REMOTE AVALANCHE CONTROL SYSTEMS INSTALLATION PANTHER (PATH NO. 48)				
FILE NUMBER	PROJECT NUMBER	REG	DRAWING NUMBER	REV
-	26265-0000	-	R2-1234-103	0

1. GENERAL NOTES

- 1.1. Pile Cap has been designed in accordance with MoTI Standard Specification 2020.
- 1.2. Contractors, suppliers, subtrades, etc. are to ensure that they are working on current drawings and should verify that they are in possession of the latest issue. Disregard obsolete drawings. Do not build from drawings unless they indicate "issued for construction".
- 1.3. Specified loads (not factored):
Importance category = Low.
Dead Load of tower = 1.980 kg (LS6-5 Wyssen Avalanche Control Tower).
Refer to Geotechnical Design Report dated 2023-07-21 (Ecora file no. 201740-04) for climatic and seismic information.
- 1.4. Foundations have been designed with a maximum ULS bearing stress calculated at 820 kPa (17,000psf), for given factored design loads. All site preparation and bearing capacity to be reviewed by a registered geotechnical engineer prior to forming foundation. Pile cap to be placed on well compacted base free of organics.
- 1.5. All products specified on drawings to be installed in accordance with the manufacturer's written instructions.
- 1.7. Do not scale drawings.
- 1.8. The contractor is responsible for all temporary bracing and shoring required for construction loading and stability until the project is completed.
- 1.9. The contractor is responsible for ensuring that all roof rainwater and foundation drains are discharged in accordance with local authority having jurisdiction.
- 1.10. All mechanical, electrical, plumbing, ventilation and draining design shall be performed by others if required by the local authority.
- 1.11. All construction to be in accordance with MoTI Standard Specifications SS 145. All changes shall be forwarded to Ecora prior to proceeding with construction.
- 1.12. The contractor shall check and verify all dimensions, elevations and conditions prior to starting construction. The engineer shall be notified immediately of any discrepancies or inconsistency between structural drawings and architectural drawings. Any discrepancies not reported become the responsibility of the contractor.
- 1.13. If site conditions differ from those anticipated or as shown on the drawings (building, building components, property lines, soil conditions etc.), the contractor shall immediately notify the engineer for corrective or remedial work. Failure to notify engineer will make the contractor responsible for all conditions and costs associated.
- 1.14. The contractor is responsible for all costs associated with the correction of deficiencies as directed by the engineer.
- 1.15. Contractor must ensure that construction loads imposed on the structure do not exceed the specified loads noted above.
- 1.16. Contractor to ensure that concrete is ground smooth and tower is plumb prior to tightening of shear relief anchors to structure. Contractor to request leveling grout specification if required and tolerances as per manufacturers guidelines.
- 1.17. The contractor shall be responsible for the construction sequence of tower erection and installation as per manufacturers specifications. All temporary works required for tower erection shall be signed and sealed by an engineer licensed to practice in British Columbia and experienced with design of temporary works similar to temporary works required for this project.

2. CONCRETE NOTES

The concrete plant, equipment, and materials shall comply with the requirements of SS 211.

2.1. CONCRETE

- 2.1.1. All cold weather concreting shall be in accordance with MoTI Standard Specifications SS 211.19.

CONCRETE MIX DESIGN REQUIREMENTS	
CONCRETE TYPE	PILE CAP
CSA EXPOSURE CLASS	F-1
MIN 28 DAY COMPRESSIVE STRENGTH, MPa	32
MIX W/C/M RATIO	0.50
MAX AGGREGATE SIZE, mm	19
CEMENT TYPE	GU
AIR CONTENT, %	5-8%
CURING	TYPE 1

- 2.1.2. Provide 3/4" (19mm) chamfer on all exposed corners and edges.
- 2.1.3. Mixing and placing of concrete shall be in accordance with MoTI Standard Specifications SS 211.
- 2.1.4. Support concrete adequately until it has reached sufficient strength to carry the imposed loads.
- 2.1.5. Embedded materials shall be free from grease, scale, and other coatings.
- 2.1.6. Refer to architectural, mechanical and/or electrical drawings (as applicable) for holes, nailers, inserts, etc. that are required to be cast into the concrete.
- 2.1.7. Cement shall meet the requirements of CSA A3000 and be type 10 (normal) unless otherwise shown in drawings.
- 2.1.8. Fine and coarse aggregate grading shall be in accordance with CSA-A23.1/A23.2 for normal weight concrete.
- 2.1.9. Water shall comply with CSA-A23.1, CLAUSE 4.2.2.

2.2. REINFORCEMENT

- 2.2.1. Minimum splice length unless notes otherwise.
BAR Size: 10M 15M 20M 25M
Lap (mm): 660 965 1320 2032
Lap welded wire fabric 203mm.
- 2.2.2. Unless otherwise notes, provide clear concrete cover to rebar as follows:
A. Surfaces poured against ground 75mm.
B. Formed surfaces exposed to ground or weather 50mm.
- 2.2.3. Embedded materials shall be free from grease, scale, and other coatings.
- 2.2.4. Bars for reinforcing shall be deformed bars complying with CSA-G30.18, and shall be grade 400W unless noted otherwise on the drawings.
- 2.2.5. Welded steel fabric shall comply with ASTM A1064.
- 2.2.6. The wire for tying reinforcement shall be minimum 1.6mm diameter (16GA), black annealed wire.

2.3. INSPECTION AND TESTING

- 2.3.1. During construction, an independent testing agent certified in accordance with CSA A283 shall be engaged to sample, prepare and test concrete materials in accordance with CSA-A23.1/A23.2.
- 2.3.2. All concrete test results shall be forwarded to the ministry representative within 24 hours of the test.
- 2.3.3. Transmit delivery slips shall be prepared in accordance with clause 5.2.4.5.1 of CSA-A23.1, and shall be correlated to the placement of each casting. A copy of delivery slips shall be forwarded to the ministry representative within 24 hours of delivery of concrete.

REV	DATE	REVISIONS	SIGNATURE
0	2023/08/04	ISSUED FOR TENDER	

PROFESSIONAL SEAL

DRAWN BY: T. EDMONDS	DATE: 2023-08-02
DESIGNED BY: D. KRUGER & M. ROCHE	DATE: 2023-07-21
REVIEWED BY: M. LAWS	DATE: 2023-08-04
CAD FILENAME: 201740-04	
DATE: 2023-08-04	



BRITISH COLUMBIA

MINISTRY OF TRANSPORTATION AND INFRASTRUCTURE
SOUTHERN INTERIOR REGION



avalanche control



ecora

ECORA ENGINEERING & RESOURCE GROUP LTD.
579 LAWRENCE AVE. KELOWNA, B.C. V1Y 6L8
Phone: 250-489-9757 www.ecora.ca

STRUCTURAL CONSTRUCTION NOTES - PANTHER				
REMOTE AVALANCHE CONTROL SYSTEMS INSTALLATION PANTHER (PATH NO. 48)				
FILE NUMBER	PROJECT NUMBER	REG	DRAWING NUMBER	REV
-	26265-0000	-	R2-1234-104	0

Appendix B

Panther Desktop Report



Revelstoke Remote Avalanche Control System (RACS) Desktop Assessment Panther (Path No. 48)

Presented To:



Ministry of
Transportation
and Infrastructure

Dated: February 2023

Ecora File No.: 201740-04

THIS PAGE IS INTENTIONALLY LEFT BLANK



Presented To:

BC Ministry of Transportation and Infrastructure
Southern Interior Region
447 Columbia Street
Kamloops, BC, B2C 2T3

Prepared by:

Prepared by:

ISSUED FOR REVIEW

Daniel Tamas, G.I.T. Date
Geoscientist in Training
daniel.tamas@ecora.ca

ISSUED FOR REVIEW

Naomi Mason, M.Sc., P.Geo. Date
Engineering Geologist
naomi.mason-herrtage@ecora.ca

Prepared by:

ISSUED FOR REVIEW

D. J. Kruger, M.Eng. Date
Geotechnical Consultant
dewald.kruger@ecora.ca

Reviewed & Approved by:

ISSUED FOR REVIEW

Michael J. Laws, P.Eng. Date
Senior Geotechnical & Dam Safety
Engineer
michael.laws@ecora.ca

Version Control and Revision History

Version	Date	Prepared By	Reviewed By	Notes/Revisions
A	2023-02-24	DT/NM-H/DJK	MJL	ISSUED FOR REVIEW

Limitations of Report

This report and its contents are intended for the sole use of the BC Ministry of Transportation and Infrastructure, their agents, and the applicable regulatory authorities. Ecora Engineering & Resource Group Ltd. (Ecora) does not accept any responsibility for the accuracy of any data, analyses, or recommendations contained or referenced in the report when the report is used or relied upon by any Party other than the BC Ministry of Transportation and Infrastructure, their agents, the applicable regulatory authorities or for any Project other than that described in this report. Any such unauthorized use of this report is at the sole risk of the user.

Where Ecora submits both electronic file and hard copy versions of reports, drawings, and other project-related documents, only the signed and/or sealed versions shall be considered final and legally binding. The original signed and/or sealed version archived by Ecora shall be deemed to be the original for the Project. Both electronic file and hard copy versions of Ecora's deliverables shall not, under any circumstances, no matter who owns or uses them, be altered by any party except Ecora.

Table of Contents

1.	Introduction	1
1.1	General	1
1.2	Scope of Work.....	1
1.3	Site Description	1
2.	Background Review	2
2.1	Sources of Information	2
2.2	BC MoTI Snow Avalanche Atlas	3
2.3	Climate.....	3
2.4	Historical Aerial Photographs Review	4
2.5	Geology.....	5
2.6	Water Well Database	5
2.7	Seismicity	6
2.8	Maintenance Contractor Rock Fall Records.....	6
3.	Overview-Level Terrain Classification	6
4.	Summary of Anticipated Site Conditions	7
4.1	Overview	7
4.2	Anticipated Geohazards at RACS location.....	8
5.	Preliminary Geotechnical Design Considerations	9
5.1	Proposed RACS Target Locations	9
5.2	RACS Type	10
6.	Geotechnical Recommendations for Detailed Design.....	11
6.1	Proposed Geotechnical Analysis.....	11
6.2	Anticipated Foundation Design	11
6.2.1	General	11
6.3	Proposed Detailed Site Reconnaissance	13
6.3.1	Chemical Degradation of Reinforced Concrete.....	13
6.3.2	Frost Penetration	13
7.	Preliminary Construction Considerations.....	14
7.1	Accessibility.....	14
7.2	Rock Scaling	14

7.3 Potential RACS Tower Locations 14

8. Schedule for Delivery 14

9. Closure..... 15

List of Tables in Text

Table 2.1 Columbia Program Path #48Overview 3

Table 2.2 Historical Weather Data Summary Clanwilliam Station #38124 (1999-2022)..... 4

Table 2.3 Summary of Aerial Photographs Reviewed 4

Table 2.4 “Site Class C” Design PGA and Sa(T) for the RACS at the Panther Priority Path 6

Table 3.1 Terrain Classification at the Panther Priority Pass 7

Table 6.1 Anticipated Foundation Specifications..... 13

List of Figures in Text

Figure 1-1 DEM constructed from higher and lower resolution LiDAR..... 2

Figure 5-1 Proposed RACS explosive locations. 10

Figure 6-1 Anticipated foundation design. 12

Appendix Sections

Figures

Figure 3.1 Terrain Classification Map

Photographs

Photo 1 Panther overview
Photo 2 Panther approximate proposed area
Photo 3 Panther existing landing area

Appendices

Appendix A BC MoTI Columbias Program Snow Avalanche Atlas – Panther (pg. 202-203)

Acronyms and Abbreviations

AEP	Annual Exceedance Probability	NBCC	National Building Code of Canada (2020)
AGS	Australian Geomechanics Society	NRCan	Natural Resources Canada
ARD	Acid Rock Drainage	P.Eng.	Professional Engineer (registered with EGBC)
ASCE	American Society of Civil Engineers	P.Geo.	Professional Geoscientist (registered with EGBC)
BC	(Province of) British Columbia	PGA	Peak Ground Acceleration
BCBC	British Columbia Building Code (2018)	PLT	Point Load Test
BC AGRI	British Columbia Ministry of Agriculture	PTI	Post-Tensioning Institute
BC MoE	British Columbia Ministry of Environment	RACS	Remote Avalanche Control System
BC MoTI	British Columbia Ministry of Transportation and Infrastructure	RISC	Resource Inventory Standards Committee
BC SIFT	British Columbia Soil Finder Information Tool	Sa(T)	Spectral Acceleration
CFEM	Canadian Foundation Engineering Manual	SSHC	Standard Specifications for Highways
CHBDC	Canadian Highway Bridge Design Code (2016)	TCH 1	Trans-Canada Highway 1
CPR	Canadian Pacific Railway	UBC	University of British Columbia
DEM	Digital Elevation Model	UCS	Uniaxial Compressive Strength
EGBC	Engineers and Geoscientists British Columbia		
FoS	Factor of Safety		
GIC	Geographic Information Centre		
GSC	Geologic Survey of Canada		
G.I.T	Geoscientist in Training (registered with EGBC)		
LiDAR	Light Detection and Ranging		
LKI	Landmark Kilometer Inventory		
m asl	meter(s) above sea level		
MCRR	Maintenance Contractor Rockfall Reports		
ML	Metal Leachate		

1. Introduction

1.1 General

Ecora Engineering & Resource Group Ltd. (Ecora) has been retained by the British Columbia Ministry of Transportation and Infrastructure (BC MoTI) to provide geotechnical engineering services for three proposed Remote Avalanche Control System (RACS) sites to be situated along the Trans-Canada Highway (TCH) near Revelstoke, BC. The project may also include the construction of avalanche catchment areas at select locations along the TCH.

The three Priority Paths are Panther, Silver Creek (approximately 46 km and 30 km, respectively, east of Revelstoke), and Victor Lake (approximately 15.5 km west of Revelstoke). Typically, the RACS towers are eight to ten metres high and are inclined to overhang an avalanche initiation zone. The system allows the BC MoTI to undertake avalanche control during all weather conditions, at any time, thereby reducing the risk of uncontrolled avalanches impacting highway traffic and allows the BC MoTI to better manages its assets.

This desktop geotechnical assessment focuses on the Panther Priority Path (Path Number 48) and is intended to provide high level geohazard and geotechnical engineering inputs to assist with the design of the RACS. It is understood that the project objective it to install one proposed RACS tower at the Panther site in the fall of 2023.

This work was approved by Heidi Evensen, (P.Eng.) Geotechnical Engineer with the BC MoTI. Work will be carried out in accordance with applicable the BC MoTI Standards and Technical Circulars, the *Professional Governance Act* (2021), and relevant Professional Practice Guidelines, as published by Engineers and Geoscientists British Columbia (EGBC).

1.2 Scope of Work

The geotechnical scope of work for this project was outlined in Ecora's *Geotechnical Work Plan: TransCanada Highway (HWY 1) – RACS-TCH Revelstoke East and West* (2023), and included a phased approach; however, this report pertains to Phase 1, Task 3, as outlined below:

- Phase 1:
 - Task 1: Project Planning, Coordination, and Project Management.
 - Task 2: Background Review and Site Reconnaissance with a stand-alone Site Reconnaissance Report.
 - Task 3: Desktop Review Reports for each Priority Path (Panther, Silver Creek, and Victor Lake).

1.3 Site Description

The TCH is a major transcontinental west-east highway that traverses the breadth of Canada between the Pacific and Atlantic Oceans. Within British Columbia (BC) it traverses through a number of mountain passes, which are subject to seasonal avalanches. The Panther Priority Path is located just outside the western boundary of Glacier National Park, BC, approximately 300 m east of the Jack MacDonald snowshed, and 425 m west of the Twins snowshed.

The Panther Priority Path is located on a southeast facing slope in the Selkirk Mountain range and lies at an elevation between 1,300 m above sea level (m asl) to 920 m asl (TCH 1 elevation). The Illecillewaet River flows parallel to the TCH 1 (downslope) and drains into Upper Arrow Lake to the west.

The site is characterized by a veneer of soil which is anticipated to overlie bedrock at shallow depth. Dense vegetation coverage, predominantly mature conifers, and sparse shrubs are located in the vicinity of the proposed tower location area.

A Digital Elevation Model (DEM) has been produced from LiDAR data using GEM4D software of the Panther Priority Path. The DEM has been constructed from high-resolution LiDAR data received from the BC MoTI which was supplemented by publicly available information (Terrain Resource Information Management, GeoBC). The high-resolution LiDAR data did not cover the full extent of the project area; therefore, lower resolution data was used to supplement the evaluation of the proposed RACS location towards the top of the approximate avalanche path.

The DEM has been used to evaluate the steepness of terrain, and the approximate avalanche path is indicated in Figure 1-1.

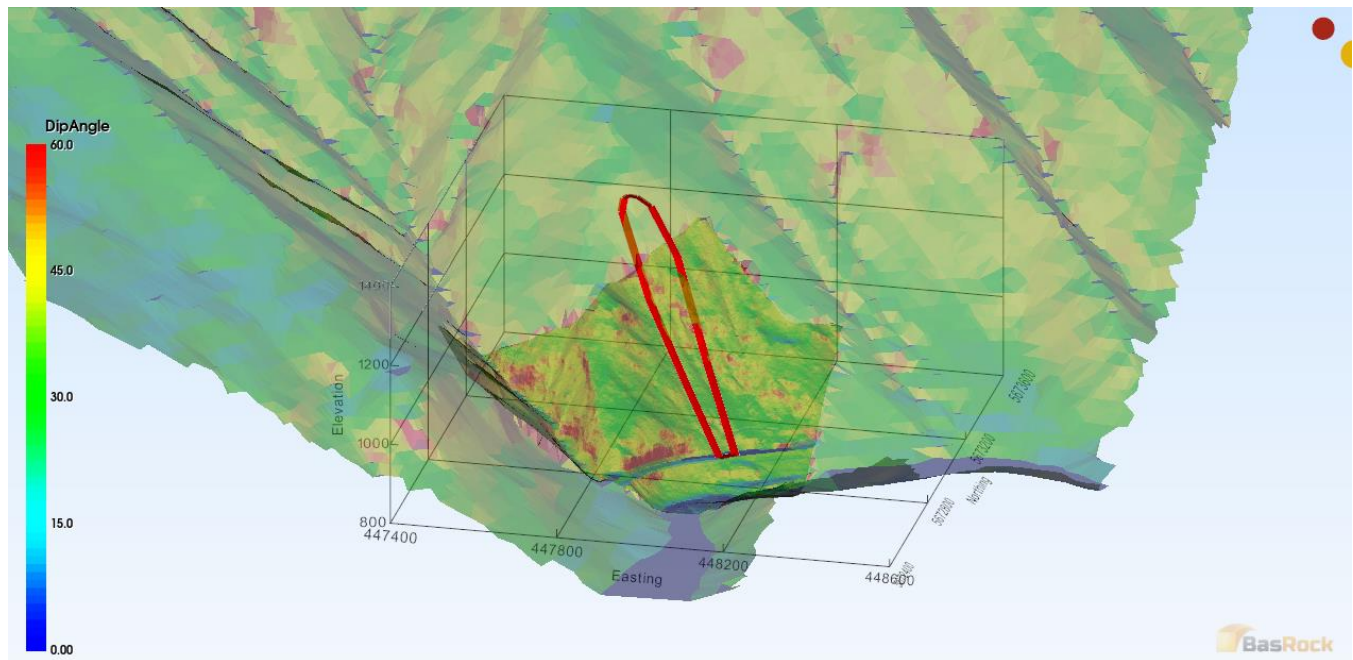

Figure 1-1 DEM constructed from higher and lower resolution LiDAR.

The slope of the terrain around the proposed RACS location at the top of the approximate avalanche path is generally less than 60° . Ecora has inferred bedrock at locations with slopes greater than 60° (Hung, 2014), which is seen to occur in sporadic positions around the proposed RACS location (indicated as red colours in Figure 1-1). Based on this, bedrock is anticipated to be at surface or very shallow depth below the soil layer.

The overall steepness of the terrain suggests that rope access and fall arrest equipment will have to be used during investigation and construction of the RACS.

2. Background Review

2.1 Sources of Information

Ecora reviewed the following relevant background information related to the project.

- *Revelstoke Remote Avalanche Control Systems (RACS), Site Reconnaissance Report (Ecora, 2023).*

- BC MoTI Columbia Program Snow Avalanche Atlas (BC MoTI, 2015).
- BC MoTI Road Weather Stations (RWS) data.
- The University of British Columbia (UBC) Geographic Information Centre (GIC) – historic aerial photographs.
- Readily available published sources of geologic data.
- iMapBC Water Well database.
- The National Resources Canada (NRCan) seismic hazard information.
- Point cloud information, contour maps and orthophotos) for received from MoTI.
- MC MoTI Maintenance Contractor Rock Fall Reports (MCRR) records for the Panther Priority Path area.

2.2 BC MoTI Snow Avalanche Atlas

The BC MoTI Columbia Program Snow Avalanche Atlas (BC MoTI, 2015) provides a high-level overview of the Panther Priority Path site (attached in Appendix A). The report describes Panther Path #48 as starting within the area between two open rock slopes separated by sparse coniferous vegetation on the western side. On the eastern side the avalanches can initiate from steep slopes in the mature forest.

The avalanche track consists of two narrow shallow gullies bordered by dense coniferous vegetation which converge under the coniferous canopy to become one gully. The steep slopes under the forest canopy on the eastern side of the start zone also flow into this gully. The lower portion of the track is bordered by dense immature coniferous vegetation which overhangs and hides the track from aerial observation. The gully opens out onto a broad open slope directly above the highway.

Table 2.1 Columbia Program Path #48 Overview

Panther Terrain Characteristics Path Number: 48		
Terrain Characteristics:		
Vertical Fall: 455 m	Starting Zone: 1370 m asl - 1220 m asl	
Aspect: Southeast	Runout Zone: 915m asl - 915 m asl	
Slope:		
Starting Zone: 38°	Track: 40°	Runout Zone: 0°
Slope Hazards:		
Type: Avalanche, Sluffing	Event Frequency: 1 per year (12-month return period)	
Infrastructure in Path:		
Road Width: 7 m	Road Length: ~35m	

2.3 Climate

The BC MoTI weather station RWS Albert Canyon (Station Code: 38227) is located approximately 3.5 km southwest of the Panther Priority Path site, at an elevation of approximately 870 m asl, and provides historical weather records relevant to the site between November 23, 1999, and October 17, 2022. Data was collected twice per day at 06:00 hours and 18:00 hours; however, only between the months of October to April, annually.

The RWS Albert Canyon weather station data indicates that the average daily maximum temperature generally remains below freezing (<0°C) between November through to February. Average monthly new snow accumulation peaks in January (3.16 m), while the average total snowpack peaks in February (1.19 m). Table 2.2

provides a summary of the average minimum and maximum temperatures, average monthly sum of new snow, and average total snowpack for the months of October through to April, recorded at the RWS Albert Canyon station between 1999 and 2022.

Table 2.2 Historical Weather Data Summary Clanwilliam Station #38124 (1999-2022)

Month	Average Maximum Temperature (°C)	Average Minimum Temperature (°C)	Average Monthly Sum of New Snow (m)	Average Total Snowpack (m)
October	6.8	1.6	0.99	0.05
November	-0.3	-3.1	1.46	0.21
December	-4.3	-7.3	2.33	0.62
January	-3.6	-7.0	3.16	0.98
February	-1.5	-6.9	2.54	1.19
March	3.35	-2.9	2.69	1.10
April	8.29	-0.58	1.03	0.53

2.4 Historical Aerial Photographs Review

Available historic aerial photography obtained from the Geographic Information Centre (GIC) at the University of British Columbia (UBC) for the area between 1949 and 2005 was reviewed to assist with identifying large scale geomorphological features that would be difficult to identify in the field. Identification of features is limited to the resolution and the elevation at which the aerial photography was taken. Table 2.3 summarizes the aerial photographs (year, scale, type) used.

Table 2.3 Summary of Aerial Photographs Reviewed

Year	Aerial Photo No.	Scale	Type
1949	A12162: 158-161 A12341: 58-62; 80-85	Not available	Black and White
1951	BC1382: 54-58; 81-86; 117-118 BC1384: 1-2	Not available	Black and White
1961	BC4006: 73-77; 175-180 BC4007: 1-7; 103-108	1:15,840	Black and White
1975	BC7801: 216-219; 225-230 BC7802: 43-49	Not available	Black and White
1984	BC84087: 123-126; 177-182; 185-189	1:20,000	Black and White
1988	BCC874: 125-128; 140-149; 174-184; 195-202 BCC877: 1-5	1:10,000	Colour
1991	BCB91174: 51-56; 80-87; 188-194; 208-210	1:15,000	Black and White
1996	BCB96077: 60-68; 133-137; 232-233 BCB96078: 49-54	1:15,000	Black and White
2005	BCC05037: 165-167; 186-188	1:20,000	Colour

Review of the aerial photographs noted the following:

- By 1949, the study area is an oval-shaped disturbance scar surrounded by forested land at the upper portion of the path (shown as $\frac{Cv-RsV}{R}$ / R on Figure 3.1), tapering into a narrow gully disturbance channel

extending downslope to the river. The disturbance path is north-south oriented in the open upper area for approximately 140 m in length, then adjusts to northwest-southeast in its lower alignment. The site is located on the central portion of the forested landscape between adjacent large avalanche sheds extending to the mountain peaks approximately 400 m laterally from the site to the central valley channel ($\frac{Cv}{R}$). The gully disturbance path appears to be the west extent of a historic disturbance cone that has been fully revegetated. Disturbance areas above the study area within the forested area are oriented into the larger avalanche sheds laterally from the site.

- By 1961 the disturbance zone contains some vegetation regeneration immediately below the main source zone and in various mid-slope locations, however, some active disturbance paths remain cleared of vegetation. The presence of some minor regeneration with continued active disturbance paths indicates ongoing slope movement, likely avalanche and debris falls, however, lesser in magnitude than the original event, thereby creating inactive areas within the historical disturbance path. Additionally, major highway works are underway resulting in a cut slope at the base of the mountain immediately within the disturbance path.
- By 1984 the historic disturbance cone is well-defined and visible in the imagery. Ongoing disturbance events may be impacting the existing disturbance paths making them more defined, or the features may appear visibility may be a result of better image resolution and the angle of the photo.
- By 1988 some new disturbance is visible on the east side of the historic disturbance cone approximately halfway down the study area. There is no visible runout path from the new disturbance zone indicating either minor material movement or an isolated event.

Historic Google Earth™ images were used to supplement the aerial photography of the project site between 2002 and 2018. The following additional observations were made:

- By 2013 no major changes to the topography or vegetated boundary of the Priority Path were identified in the available imagery. Avalanche activity in the major avalanche tracks east and west of the Priority Path is identifiable by lower slope snow deposition below the TCH and the Jack MacDonald and the Twins Snowsheds.
- By 2018 no major changes to the topography or vegetated boundary of the Priority Path were identified in the available imagery. The Priority Path shows snow deposition patterns indicative of an avalanche event previously cleared from the active road lanes. Deposition is spread across the shoulder of the road centered around the base of the Priority Path with some visible soil in the lower exposed slope above the TCH.

2.5 Geology

MapPlace2 (beta) (Cui et al., 2017) indicates the underlying geology at the Panther Priority Path consists of mudstone, siltstone, and shale, including fine clastic sedimentary rocks (namely micaceous schist); and impure marble from the Index Formation of Cambrian to Devonian age. No Quaternary geologic information was found for the Panther Priority Path area at the time of this assessment.

A thrust fault is mapped perpendicular to the TCH 1 (Cui et al., 2017), approximately 350 m southwest of the Panther Priority Path, and loosely correlates through the drainage channel of an unnamed tributary draining to the Illecillewaet River on the southeast facing slope. The thrust fault is the first in a series of northwest-southeast trending thrust faults progressing to the west, towards the township of Glacier, BC. West of the township of Glacier, the fault series become normal faults and continue to trend northwest / southeast. The bedrock geology is shown to be consistent on both sides of the thrust fault.

2.6 Water Well Database

Reference to the Provincial Well Database, iMapBC, indicates that there is no water well records within close proximity to the project site, or at a comparable elevation.

The nearest water way is the Illecillewaet River, approximately 100 m downslope of the TCH 1.

2.7 Seismicity

The *Bridge Standards and Procedures Manual, Supplement to CHBDC S6-19* (MoTI, 2022) stipulates that structures shall be designed for no-collapse under multiple earthquake design levels (475, 975, and 2,475), with peak ground acceleration (PGA) values as determined by the GSC and reported in the National Building Code of Canada (NBCC, 2020).

The GSC has developed a probabilistic (6th Generation) seismic hazard model (Kolaj et al., 2020) that forms the basis of the seismic design provisions of the 2020 National Building Code of Canada (NBCC, 2020), British Columbia Building Code (BCBC, 2018), and Canadian Highway Bridge Design Code (CHBDC; CSA, 2019).

Peak Ground Accelerations (PGA) and Spectral Accelerations (Sa(T)) for a reference “Site Class C” (very dense soil and soft rock) can be obtained from the Earthquakes Canada website for various return periods, with the reference values for the proposed RACS at the Panther Priority Path is summarized in Table 2.4 below.

Table 2.4 “Site Class C” Design PGA and Sa(T) for the RACS at the Panther Priority Path

Annual Exceedance Probability (AEP)	PGA (g)	Sa(0.2) (g)	Sa(0.5) (g)	Sa(1.0) (g)	Sa(2.0) (g)
1/475	0.0355	0.0827	0.0622	0.0364	0.021
1/1,000	0.0565	0.134	0.0961	0.0548	0.0325
1/2,475	0.0963	0.233	0.161	0.0879	0.0529

2.8 Maintenance Contractor Rock Fall Records

The BC MoTI provided Maintenance Contractor Rockfall Report (MCRR) records for the Panther Priority Path area at LKI km 45.96 to km 46.0 (RFI LM km 0.35 to km 0.39), between 1994 and 2018. No events were recorded in the immediate vicinity of the Panther Priority Path.

The MCRR reports indicate that 1 event has occurred and reached the highway at the closest location at the Jack MacDonald Snowshed, at approximately LKI km 45.67.

The relatively low number of rock fall events for the Panther Priority Path compared to the other proposed RACS sites is in part attributed to the dense vegetation coverage of the slope above the TCH, and may not be representative of the rock fall hazard at the proposed RACS tower location.

3. Overview-Level Terrain Classification

Ecora has developed an overview-level terrain classification map (see Figure 3.1) based on historical aerial photography, LiDAR data, and additional publicly available information reviewed. The terrain classification was undertaken in accordance with the BC Terrain Classification System (Howes & Ken, 1997), and following the BC Province methods for terrain mapping (RISC, 1996). These methods represent current standards of practice for terrain mapping in BC and provide a consistent standardized approach.

Interpretation of the terrain indicates the project area is bedrock controlled and predominantly underlain by a colluvial veneer. At the foot of the slope, along the TCH, the terrain is comprised of alluvial deposits.

Table 3.1 Terrain Classification at the Panther Priority Pass

Material Type	Map Symbol	Interpretation	Description
Anthropogenic	Aa/R	Anthropogenic, moderate slope; some Bedrock exposure	Terrain with a history of significant human modification including cut and fill slopes.
Colluvial Sediments	$\frac{Cv - RsV}{R} / R$	Colluvial, veneer – Rapid Mass Movement, debris slide, Gully Erosion, over Bedrock; some Bedrock exposure	Represents historic and/or active erosion and deposition of unconsolidated and unsorted sand, gravel, cobbles, and boulders through the process of mass movement.
	$\frac{Cv - R^I s}{R}$	Colluvial, veneer – Rapid Mass Movement (inactive), debris slide, over bedrock	
	$\frac{Cv}{R}$	Colluvial, veneer, over Bedrock	
	$\frac{Cv - V}{R} // R$	Colluvial, veneer – Gully Erosion, over Bedrock; minor Bedrock exposure	
	$Cva - AfRbV/R$	Colluvial, veneer, moderate slope – Avalanche, major track, Rapid Mass Movement, rockfall, Gully Erosion; some Bedrock exposure	
	$CvR \cdot R$	Colluvial, veneer; equal cover to Bedrock exposure	
Bedrock	$Rrs - AvRbV // \frac{Cv}{R}$	Bedrock, ridge, steep – Avalanche, mixed major and minor tracks, Rapid Mass Movement, rockfall, Gully Erosion; minor Colluvial, veneer, over Bedrock	Exposed bedrock comprising moderately steep to steep slopes (27° to >35°).

In Figure 3.1, the Proposed Avalanche Target Path location as received from the BC MoTI is offset from the aerial photography that was used in the terrain classification for this report. It is recommended that the exact location of Proposed Avalanche Target Path be verified upon consultation with the BC MoTI.

4. Summary of Anticipated Site Conditions

4.1 Overview

Based on Ecora’s understanding of the project, the background review of available information, and the site reconnaissance we found the following:

- The site is comprised of a historic disturbance area located at approximately 1300m asl tapering into a gullied erosion path extending down to the TCH. The disturbance path is north-south oriented in the open upper area for approximately 140 m in length, then adjusts to northwest-southeast in its lower alignment.
- Based on the disturbance pattern, topographic setting, and geological setting the feature is believed to be a historic debris slide funnelled into a gully path. After the initial disturbance event, the terrain is described as an exposed slide feature with shallow soils and some bedrock exposure. The open upper exposure is believed to be the snow avalanche source zone, which is funnelled downslope into a moderately steep gullied erosion path. The terrain feature size and location have allowed for suitable conditions to source small (relative to adjacent major track events) avalanche events and convey them downslope to the TCH.
- The Panther Priority Path is located on an isolated forested ridge between two major avalanche valleys with snowsheds extending into the upper ridge of the mountains above 2000 m elevation.

- The geology of the project area is underlain by mudstone, siltstone, and shale, including fine clastic sedimentary rocks (namely micaceous schist); and impure marble.
- A thrust fault is mapped perpendicular to the TCH 1, approximately 350 m southwest of the Panther Priority Path, and loosely correlates through the drainage channel of an unnamed tributary on the southeast facing slope.
- Based on the site reconnaissance, the priority path and surrounding slopes are believed to be subject to rock fall and/or shallow landslide events. The proposed RACs location will be subject to these events as well should detachment occur upslope of the tower site.
- The dense vegetation restricted observations and therefore the evaluation of ground conditions at the Panther Priority Path. It is proposed that the ground conditions be further evaluated during the detailed geotechnical site reconnaissance.

4.2 Anticipated Geohazards at RACS location

Based on the historical air photo review the disturbance patterns of the site indicate the site is likely a historical, narrow, landslide feature that has mostly revegetated. The exposed disturbance area at the top of the site which tapers into a gully is typical of a debris slide event illustrated in Table F-1 of *Landslide Assessments in British Columbia* (EGBC 2022). These events are often related to excess water availability destabilizing a shallow soil layer at a low permeability interface, such as bedrock. The result of the original disturbance event at the priority path is a source zone exposure area above a gully feature aligned perpendicularly intersecting the TCH at the base of the slope. Potential slope hazard events in the priority path include rockfalls, avalanches, and debris slides. Slope disturbance events upslope of the tower site including avalanche tracks, debris slide scars, and rock fall paths and are generally oriented into adjacent major avalanche tracks not directly impacting the priority path.

Landslides are classified in general by two distinct aspects, the material type, and the movement type. The material type includes rock, soil, and snow; with soil being further separated into earth for sand and fine material, and debris for primarily coarse soil. The movement type can be described as fall, topple, slide, spread, and flow.

The following preliminary geohazards have been identified at the proposed RACS location:

- Debris and Snow Avalanche
 - Avalanches are described as a type of flow movement associated with abrupt and extremely rapid travel speeds. Debris avalanches are “*large, extremely rapid, often open-slope flows formed when an unstable slope collapses and the resulting fragmented debris is rapidly transported away from the slope*” (Highland & Bobrowsky, 2008). Snow avalanches often result from the detachment of a snow layer within the snowpack on an exposed slope.
 - Potential for occurrence in $\frac{Cv-RsV}{R} / R$, $\frac{Cv-V}{R} //R$, $Cva - AfRbV/R$, and $Rrs - AwRbV // \frac{Cv}{R}$ in Figure 3.1.
- Rock Fall
 - Rock falls are described as “*abrupt, downward movements of rock or earth, or both, that detach from steep slopes or cliffs. The falling material usually strikes the lower slope at angles less than the angle of fall, causing bouncing. The falling mass may break on impact, may begin rolling on steeper slopes, and may continue until the terrain flattens*” (Highland & Bobrowsky, 2008).
 - Potential for occurrence is in all terrain polygons shown in Figure 3.1 where forest openings occur allowing for downslope movement. Primary occurrence areas potentially affecting the TCH are expected to be located in $\frac{Cv-RsV}{R} / R$ and $Cva - AfRbV/R$, but may also occur in Aa/R and $\frac{Cv}{R}$ where source rocks are located immediately above the road cut.
- Shallow Debris Slide and Rock Slide

- Landslides are described as “*downslope movement of soil, rock and organic materials under the effects of gravity*” (Highland & Bobrowsky, 2008). Shallow slides are often associated with movement along a shallow interface, often a soil veneer on bedrock.
- The polygons identified as $\frac{Cv-RsV}{R} / R$ in Figure 3.1 are understood to have been formed due to past debris slide or rockslide events based on their disturbance patterns and the bedrock geology of the area. The terrain where past events occurred and the surrounding area including $\frac{Cv-R^I s}{R}$, $\frac{Cv}{R}$, and $\frac{Cv-V}{R} // R$ have the potential to host future occurrences of debris and rockslides.

5. Preliminary Geotechnical Design Considerations

5.1 Proposed RACS Target Locations

The proposed RACS explosive target locations have been identified as indicated in Figure 5-1, as received from the BC MoTI on January 27th, 2022, based on the primary helicopter explosive placements currently used to reduce snow avalanche hazard.



Figure 5-1 Proposed RACS explosive locations.

It is desirable that the final tower location be selected to avoid geohazards completely. Avoidance of geohazards is generally preferable, as opposed to the use mitigation or stabilisation measures that would require additional workings or periodic maintenance above the TCH.

5.2 RACS Type

Ecora understands that there are four types of RACS being used in BC:

- 1) The North American Avalanche Guard System.
- 2) Gazex Avalanche Exploders.

- 3) Wyssen Avalanche Towers.
- 4) O'Belx.

Ecora understands that currently, the BC MoTI is considering the use of a single Wyssen Avalanche Tower RACS for the Panther Priority Path.

The Wyssen RACS towers are typically eight to ten metres tall and are inclined so the deployment box overhangs an avalanche initiation zone. The deployment box holds up to twenty-four explosive charges, which can be individually detonated by dropping a retaining line at a pre-set height above the snow cover to trigger the avalanches.

6. Geotechnical Recommendations for Detailed Design

As it is proposed to install the RACS tower at the Panther Priority Path site in the fall of 2023 the project schedule will not accommodate the undertaking of an intrusive geotechnical site investigations in advance of detailed design. The geotechnical design of the proposed towers will be based on past experience from previous RACS tower sites in the TCH corridor and the desktop study. Assumptions used in the geotechnical design will be verified by a detailed site reconnaissance of each individual RACS tower location in early summer and verification testing of foundations during construction.

6.1 Proposed Geotechnical Analysis

After the tower locations have been selected, it is proposed that numerical analyses be undertaken to confirm the suitability of the proposed locations, as follows:

- Rock Fall Run Out Assessment
 - It is proposed that the use of spatial analyst tools to determine the expected rock fall trajectories (flow direction) at the tower catchment area.
- Micro-pile and inclined shear relief anchor design:
 - The determination of types, embedment length and number of piles/anchors required.
- Kinematic Stability Analysis
 - The analysis will identify potential failure modes based on the orientation and intersection of rock mass discontinuities.
- Global Stability Analysis
 - Limit state equilibrium stability analyses will be carried out to evaluate the long-term global stability of the slope at and above each of the tower locations under static and pseudo-static conditions and the determination of Factor of Safety (FOS).

A schedule for delivery and timelines is discussed in Section 8 of the report.

6.2 Anticipated Foundation Design

6.2.1 General

It is anticipated that structural support to the tower is to be provided by vertical micro-piles and inclined shear relief anchors. It is proposed that following design references be used in the design:

- CSA S6:19, Canadian Highway Bridge Design Code (CHBDC), 2019.
- BC MoTI Volume 1 – Supplement to CHBDC S6:19, 2022.
- BC MoTI Standard Specifications for Highway Construction 2020.
- FHWA-IF-99-015, Ground Anchor and Anchored Systems, Geotechnical Engineering Circular No.4, June 1999.
- PTI DC35.1-14, Recommendations for Pre-stressed Rock and Soil Anchors, 2014.

Figure 6-1 is provided below as an indication of anticipated foundation design for the RACS.

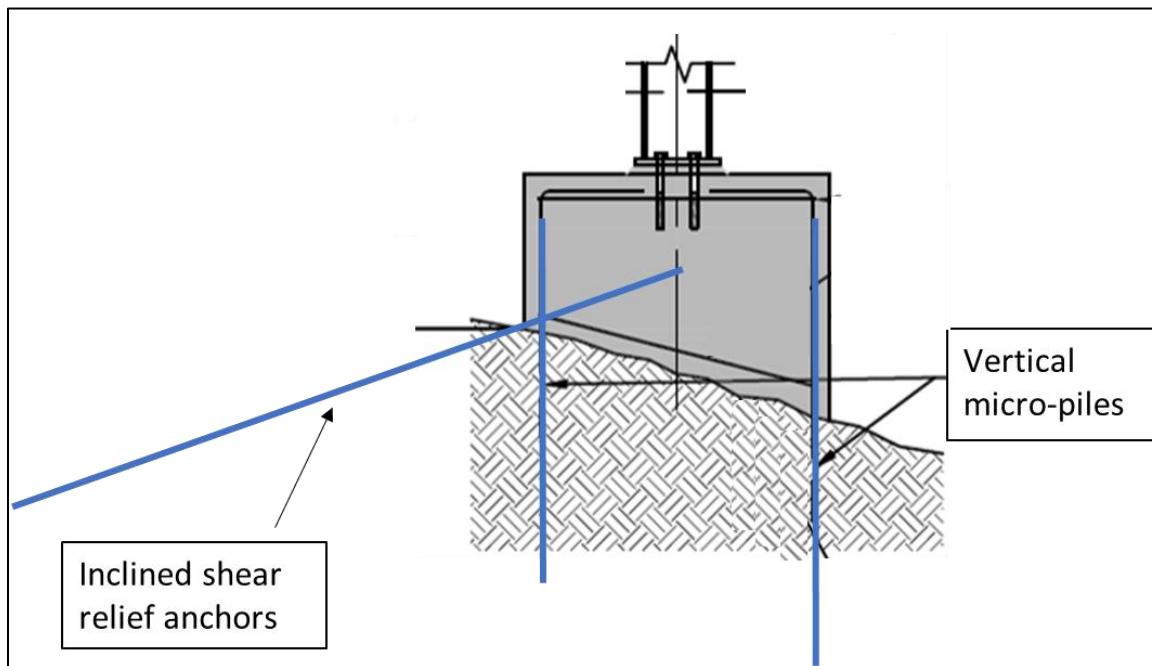

Figure 6-1 Anticipated foundation design.

The required bond lengths for the micro-piles and shear relief anchors will be calculated based on published typical average ultimate bond strengths between rock and grout as found in Table C6.1 from *Recommendations for Prestressed Rock and Soil Anchors* (Post-Tensioning Institute (PTI) DC35.1-14, 2014).

Based on Ecora's past experience for RACS tower structures (i.e., at 3-Valley Gap), in similar ground conditions, micro-piles and shear relief anchors are designed to resist factored design loads of up to 250 and 420 kN respectively. It is anticipated that the following foundation requirements would likely be required for the Panther RACS tower as summarized in Table 6.1.

Table 6.1 Anticipated Foundation Specifications

Method	Threaded Bar Diameter (mm)	Drill Hole Diameter (mm)	Steel Grade (MPa)	Minimum Required Bond Length (m)	Comments
Micro-piles	32	63.5	517	4.0	Hot dip galvanized
Shear Relief Anchors	43	76	517	5.0	Hot dip galvanized

6.3 Proposed Detailed Site Reconnaissance

It is proposed that a detailed geotechnical reconnaissance be carried out of the proposed RACS tower site to verify all assumptions utilized in site selection and detailed design of the foundations which could consist of the following:

- Rock fall hazard inspection:
 - Identification and evaluation of rock fall hazard zones that could affect the tower locations.
- Detailed structural and geological field mapping:
 - The mapping of rock outcrops to provide suitable inputs into kinematic stability analysis and foundation design. This would include an estimation of the maximum resistance of the rock mass to shearing (Barton-Bandis) based on the geometric properties of mapped discontinues and rock type. The geological field mapping will also identify rock fall sources zones, talus slopes and run-out zones to delineate areas of rock fall hazard and to provide suitable inputs into rock fall analysis utilized in the rock fall assessment.
- Determination of soil cover thickness:
 - Hand tools will be used to evaluate soil cover thickness and determine depth to bedrock at the proposed tower locations.
- Estimation of Uniaxial Compressive Strength (UCS) of intact rock:
 - In situ field strength will be estimated using a Schmidt Rebound Hammer. Select samples could also be collected for laboratory testing using a Point Load Test (PLT) apparatus.

6.3.1 Chemical Degradation of Reinforced Concrete

Chemical degradation of reinforced concrete testing should be carried out on samples collected from the site, where required. The type of chemical degradation that occur in concrete is associated primarily with chemical changes occurring within the hydrated cement matrix, of which sulphate attack is commonly the most widespread threat to concrete durability. Concrete durability can also be affected by the introduction of chloride salts either as contaminants within the concrete during manufacture or during its subsequent exposure to a chloride-laden environment, for example where it comes into contact de-icing salt.

Due to the compressed project schedule that may not permit soil testing and the relatively small volume of concrete utilized in the RACS foundation construction, the foundation design could conservatively assume the use of C-1 concrete exposure class.

6.3.2 Frost Penetration

Frost susceptibility of soils refers to the propensity of the soil to grow ice lenses and heave during freeze and thaw cycles and is related to the size distribution of soil particles (CFEM, 2006).

Foundations shall be designed so that any length of micro-pile or shear relief anchor contributing to supporting the RACS tower is beneath the maximum seasonal frost penetration depth.

It is important to note that the construction schedule plays an important role in the short- and long-term performance of foundations. Should construction be carried out over winter, a Qualified Professional Engineer shall conduct a review to confirm any winter-related design concerns (i.e., frost heave out of the subgrade) are addressed.

7. Preliminary Construction Considerations

7.1 Accessibility

The site is evaluated to only be accessible from the air and an existing helicopter landing area has been identified upslope of the proposed tower site. In its current state a helicopter would have to toe-in for ground crews to exit and enter. It is recommended that the condition of this existing pad be evaluated to determine its potential for use during the forthcoming investigation and construction phases. It may be recommended that a proper level pad be constructed at this location to ensure ease of access in the unlikely event of a safety incident.

7.2 Rock Scaling

Rock scaling may have to be undertaken during construction of the RACS. The details of any scaling required are to be verified during the geotechnical investigation.

Rock scaling at the proposed RACS location would create a hazard at the TCH and temporary rock fall protection work, and limited road closures may be required during the execution of the rock scaling works.

7.3 Potential RACS Tower Locations

Photos 1 to 3 (see attached) are provided as additional information. Photo 2 illustrates potential RACS tower locations, where preferred areas have been identified according to generalized ease of construction and geohazard considerations:

- Green = Easy accessibility, minimal surface bed preparation, competent founding medium, uncomplicated construction with minimal geohazard exposure.
- Yellow = Moderate accessibility, some surface bed preparation, unknown founding medium that may require stabilization or scaling, uncomplicated construction with minimal geohazard exposure.
- Red = Difficult accessibility, extensive surface bed preparation, unknown founding medium that may require significant stabilization or scaling, complicated sloped construction with geohazard exposure.

These areas and comments provided should be considered preliminary and are dependent on-site conditions and are subject to change. The larger area considered is dictated by the target locations and discussed in Section 5.1.

8. Schedule for Delivery

Ecora understands that an aggressive timeline is required for the overall project delivery and that BC MoTI aims to construct the tower during the 2023 construction season when the ground is snow free. To achieve this, Ecora proposes that complete the majority of the detailed design prior to conducting the detailed site reconnaissance, with the results from the reconnaissance used to finalize the design.

For the Panther Priority Path, the following is envisaged:

1. Preliminary detail design, March to May 2023
2. Detailed Site Reconnaissance, June 2023
3. Tendering, July 2023
4. Construction, September to October 2023

Based on Ecora's experience from other similar RACS projects, the construction for tower foundations (including the installation of micro-piles and shear relief anchors), and curing of the pile cap concrete (until tower erection can occur) typically takes 14 days.

9. Closure

We trust this report meets your requirements. Please contact our office if you have any questions or comments concerning this report.

References

- American Society of Civil Engineers (ASCE), 2001. "Design and Construction of Frost-Protected Shallow Foundations".
- British Columbia Ministry of Transportation and Infrastructure (BC MoTI), 2022. "Bridge Standards and Procedures Manual, Supplement to CHBDC S6-19".
- British Columbia Ministry of Transportation and Infrastructure (BC MoTI), 2015. "Columbias Program Snow Avalanche Atlas".
- British Columbia Ministry of Transportation and Infrastructure (BC MoTI), 2020. "Standard Specifications for Highway Construction".
- Canadian Geotechnical Society, 2006. "Canadian Foundation Engineering Manual, 4th Edition".
- CSA Group, 2019. "Canadian Highway Bridge Design Code", CSA S6-19.
- Cui, Y., Fortin, G., Meredith-Jones, S., Zhao, S., and Jones, L.D., 2017a. MapPlace 2 (beta) Workshop. British Columbia Ministry of Energy and Mines, British Columbia Geological Survey Information Circular 2017-3, 89 p.
- DataBC Program, 2015. iMapBC (<https://maps.gov.bc.ca/ess/hm/imap4m/>), accessed January, 2023.
- Ecora Engineering and Resource Group (Ecora), 2023. "Revelstoke Remote Avalanche Control Systems (RACS), Site Reconnaissance Report", Project number 201740-04.
- Engineers and Geoscientists British Columbia (EGBC), 2022. "Professional Practice Guidelines for Landslide Assessments in British Columbia", version 4.0.
- Environment Canada, Historical Weather, Revelstoke BC, https://climate.weather.gc.ca/climate_normals/results_1981_2010_e.html?searchType=stnProx&txtRadius=50&selCity=&optProxType=park&selPark=51%7C6%7C118%7C4%7CMount+Revelstoke+National+Park&txtCentralLatDeg=&txtCentralLatMin=0&txtCentralLatSec=0&txtCentralLongDeg=&txtCentralLongMin=0&txtCentralLongSec=0&txtLatDecDeg=&txtLongDecDeg=&stnID=1345&dispBack=02. Retrieved from the Internet on February 6th, 2023.
- Highland, L.M., and Bobrowsky, Peter, 2008. "The landslide handbook—A guide to understanding landslides". Reston, Virginia, U.S. Geological Survey Circular 1325, 129 p.
- Howes, D.E., Kenk, E, 1997. "Terrain Classification System for British Columbia (version 2)", Fisheries Branch, Ministry of Environment and Surveys and Resource Mapping Branch, Ministry of Crown Lands Province of British Columbia. MoE Manual 10 (version 2).
- Hungr, O., Lerouil, S., and Pacarelli, L. (2014). "The Varnes Classification of Landslide Types, an Update", Landslides, Volume 11, Issues 2, pp 167-194.
- Kolaj, M., Halchuk, S., Adams, J., and Allen, T.I., (2020). "Trial Sixth Generation seismic-hazard model of Canada: seismic-hazard values for selected localities", Geological Survey of Canada, Open File 8629, 1 .zip file. (<https://doi.org/10.4095/321473>).
- National Research Council of Canada (NRCC), 2020. "National Building Code of Canada:2020".
- Peckover, F. L. 1975. "Treatment of rock falls on railway lines." American Railway Engineering Association, Bulletin 653, Washington, DC, pp. 471–503
- Post-Tensioning Institute (PTI), 2014. "Recommendations for Prestressed Rock and Soil Anchors".

Province of British Columbia, 2018. "BC Building Code (BCBC)".

Resources Inventory Committee (RISC), 1996. "Guidelines and Standards to Terrain Mapping in British Columbia", Surficial Geology Task Group, Earth Sciences Task Force British Columbia.

Thompson, R.I., 2004. "Geology, Revelstoke, British Columbia", Geological Survey of Canada, Open File 4385.

U.S. Department of Transportation, Federal Highway Administration (FHWA), 1999. "Geotechnical Engineering Circular No. 4, Ground Anchors and Anchored Systems", FHWA-IF-99-015.

Wyllie, D. C. 2015. "Rock Fall Engineering". CRC Press. Taylor and Francis.

Figures

Figure 3.1 Terrain Classification Map

PRELIMINARY TERRAIN MAP - PANTHER SITE

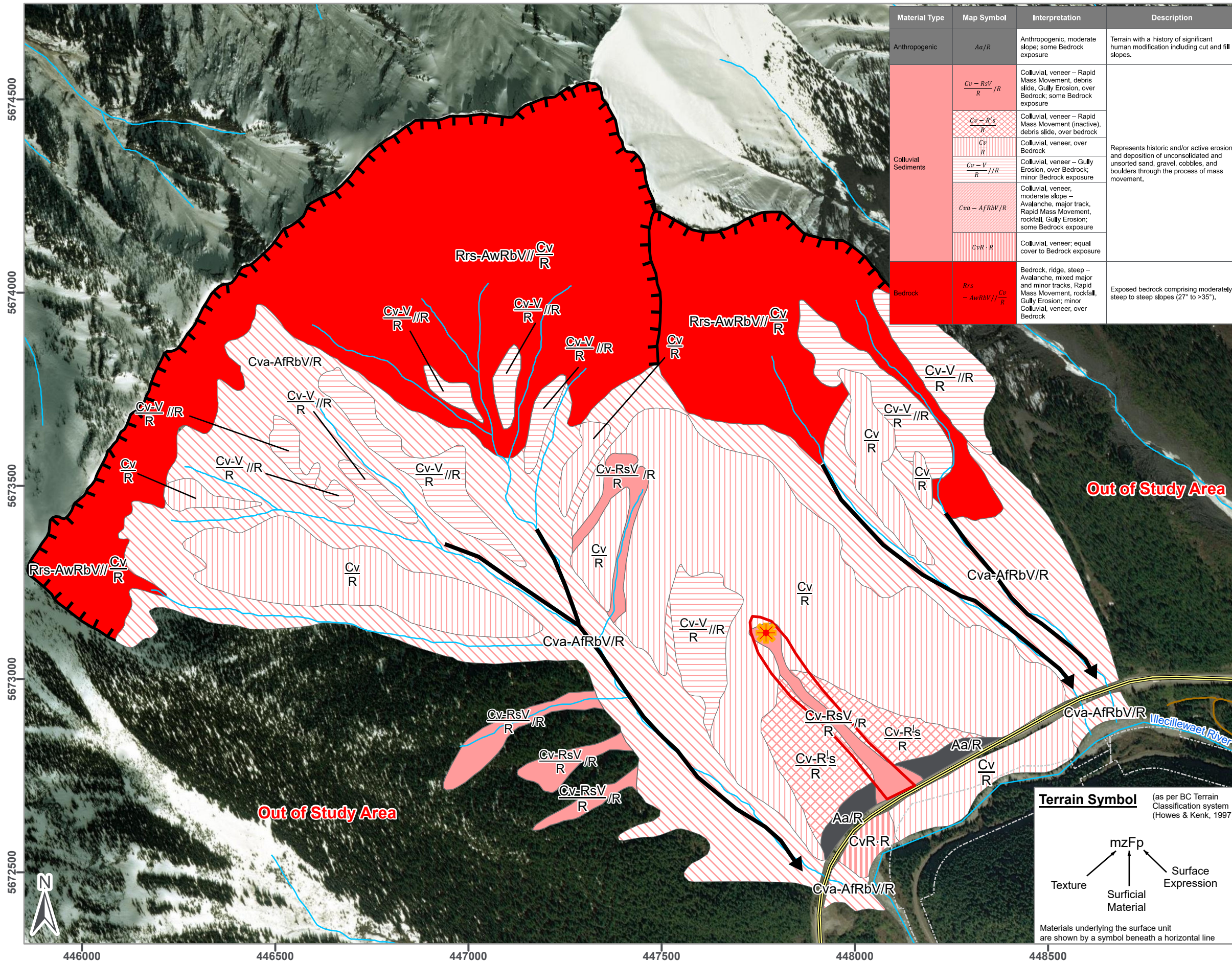

Material Type	Map Symbol	Interpretation	Description
Anthropogenic	Aa/R	Anthropogenic, moderate slope; some Bedrock exposure	Terrain with a history of significant human modification including cut and fill slopes.
Colluvial Sediments	$\frac{Cv-RsV}{R} // R$	Colluvial, veneer - Rapid Mass Movement, debris slide, Gully Erosion, over Bedrock; some Bedrock exposure	Represents historic and/or active erosion and deposition of unconsolidated and unsorted sand, gravel, cobbles, and boulders through the process of mass movement.
	$\frac{Cv-R's}{R}$	Colluvial, veneer - Rapid Mass Movement (inactive), debris slide, over bedrock	
	$\frac{Cv}{R}$	Colluvial, veneer, over Bedrock	
	$\frac{Cv-V}{R} // R$	Colluvial, veneer - Gully Erosion, over Bedrock; minor Bedrock exposure	
	$\frac{Cva-AfRbV}{R}$	Colluvial, veneer, moderate slope - Avalanche, major track, Rapid Mass Movement, rockfall, Gully Erosion; some Bedrock exposure	
Bedrock	$\frac{Rrs-AwRbV}{R} // \frac{Cv}{R}$	Bedrock, ridge, steep - Avalanche, mixed major and minor tracks, Rapid Mass Movement, rockfall, Gully Erosion; minor Colluvial, veneer, over Bedrock	Exposed bedrock comprising moderately steep to steep slopes (27° to >35°).

GEOTECHNICAL ASSESSMENT PANTHER SITE LOCATION REVELSTOKE, BC

Legend

- Approximate RACS Tower Location
- Fresh Water Atlas Streams
- Highways
- Digital Atlas Roads
- Approximate Avalanche Paths
- Proposed Avalanche Target Path (received from MoTI)
- PMBC Legal Parcels
- Escarpment

References

Aerial Imagery: Maxar, 5/9/2015
LIDAR: MoTI, 6/19/2019

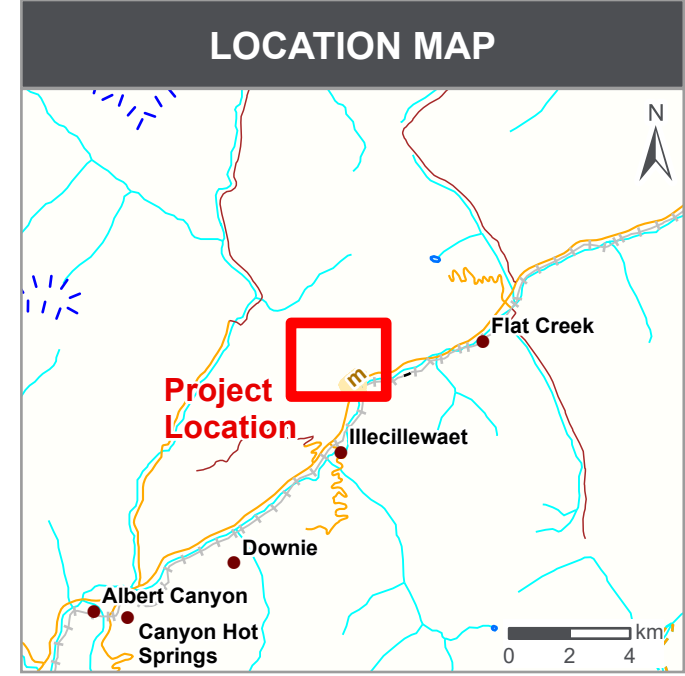

Scale: 1:10,000

Project No.: 201740-04 Date: 2023/02/24
Client: Ministry of Transportation and Infrastructure Drawn: SC Check:
NAD 1983 UTM Zone 11N

Figure 3.1

DRAFT

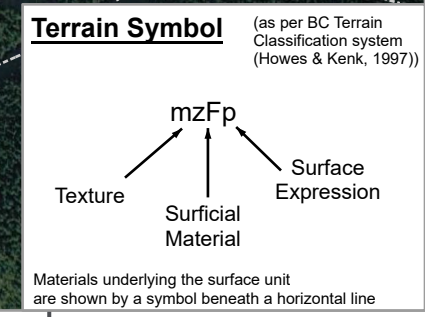

Photographs

Photo 1 Panther overview

Photo 2 Panther approximate proposed area

Photo 3 Panther existing landing area

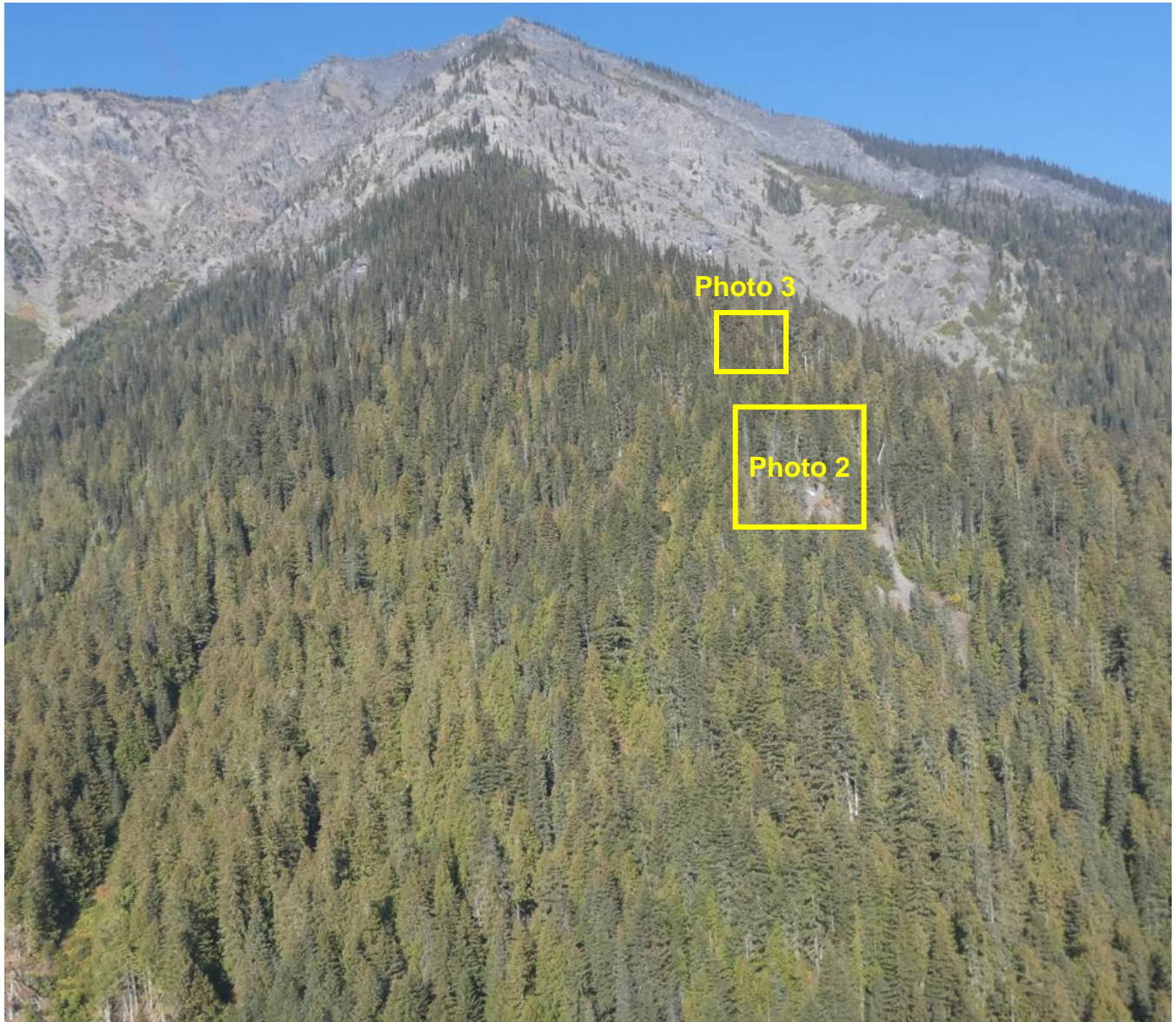

Photo 1 Panther overview

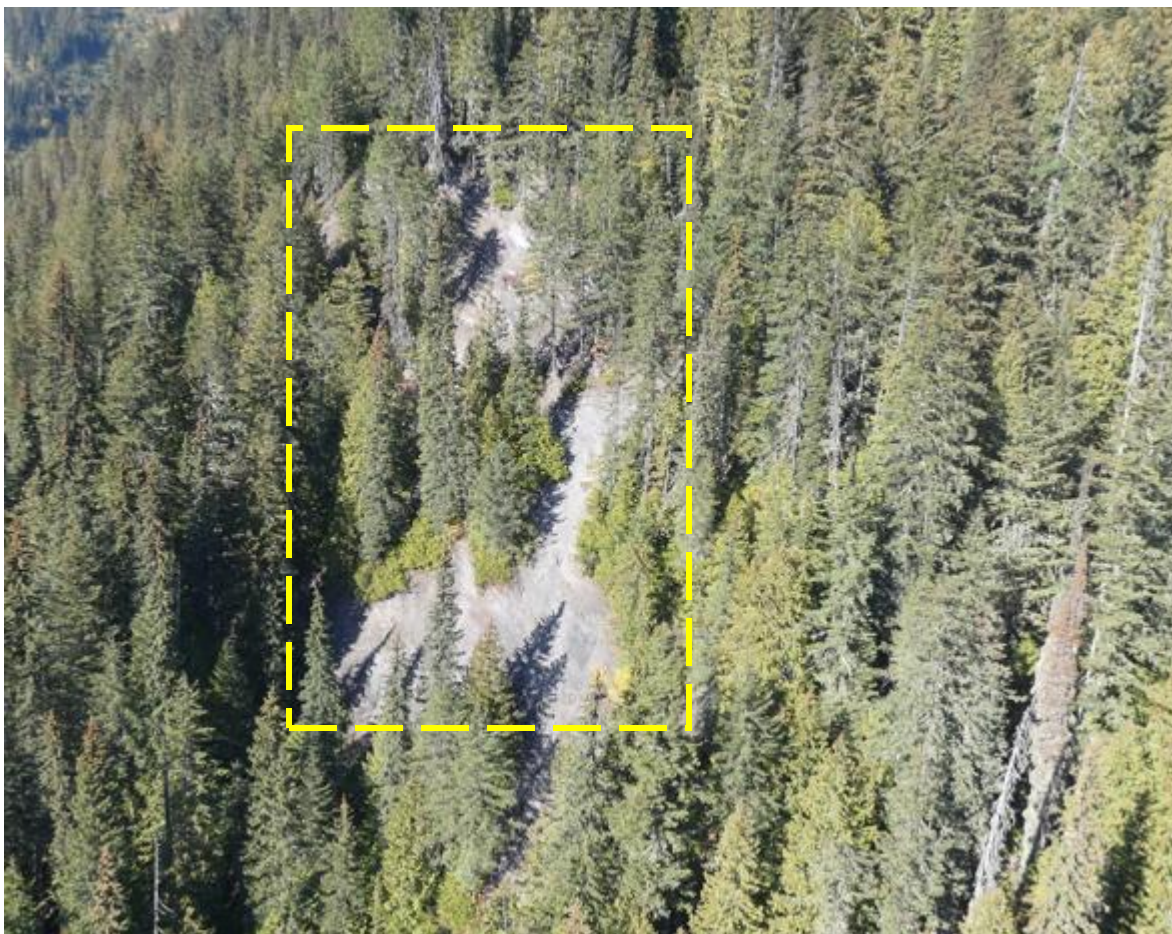

Photo 2 Panther approximate proposed area

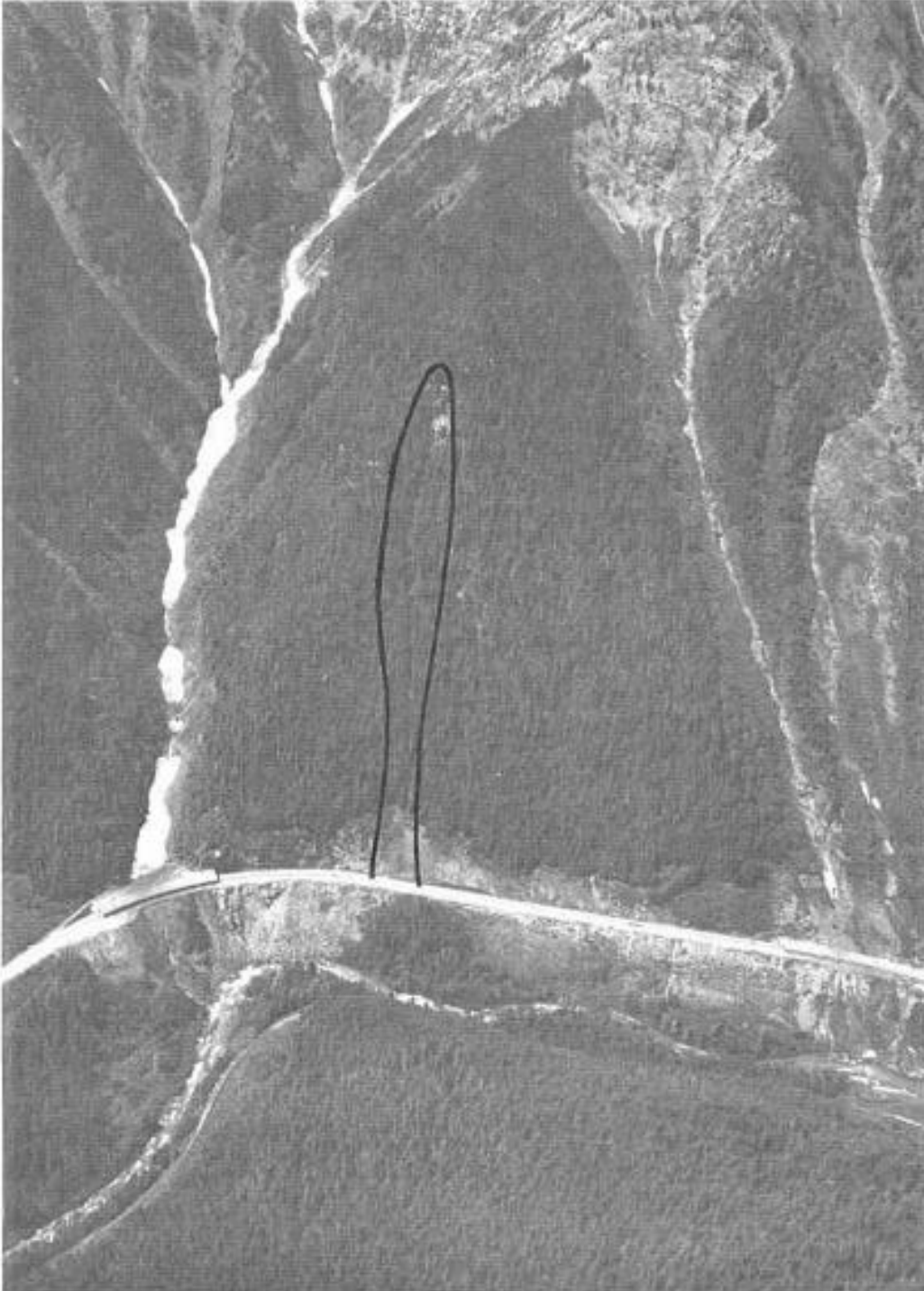

Photo 3 Panther existing landing area

Appendix A

BC MoTI Columbias Program Snow Avalanche Atlas – Panther (pg. 202-203)

PANTHER



48.0

Path # 48 [BULK UPLOAD]

PANTHER PATH SUMMARY

Path Name: **PANTHER**

Path Number: **48**

Active Path: Yes

Potential Path: No

Location:

6.3km west of Bostock Creek.

TERRAIN CHARACTERISTICS

Vertical Fall: 455 m

Slope Length to Road:

Starting Zone Area:

Site Angle to Road:

Runout Area:

Aspect: South East

Road Width: 7 m

Length of Highway Affected: m

ELEVATIONS

Starting Zone: 1370 — 1220 m

Runout Zone: 915 — 915 m

INCLINES

Starting Zone: 38 °

Track: 40 °

Runout Zone: 0 °

GENERAL DESCRIPTIONS

Starting Zone:

Two open rock slopes separated by sparse coniferous vegetation on the western side. On the eastern side the avalanches can initiate from steep slopes in the mature forest.

Track:

Two narrow shallow gullies bordered by dense coniferous vegetation which converge under the coniferous canopy to become one gully. The steep slopes under the forest canopy on the eastern side of the start zone also flow into this gully. The lower portion of the track is bordered by dense immature coniferous vegetation which overhangs and hides the track from aerial observation. The gully opens out onto a broad open slope directly above the highway.

Runout Zone:

The runout zone begin 5 metres above the highway and flows across the highway and down the slope below.

Technician Description of Path Characteristics

Length of highway affected is 35m. Sluffing and avalanches are estimated to each affect the highway an average of once per year.

Appendix C

Tower Foundation Calculations

PROJECT NAME
PROJECT NO
DATE

Panther RACS Detail Design
 201740
 28-Jun-23

Bond Capacity 0.63 MPa Based on PTI DC35.14, Table C6.1 and Foundations on Rock, Wyllie 1999)
 Bond Safety Factor 2.0 (Based on PTI DC35.14 and Foundations on Rock, Wyllie 1999)
 Min. Desired Design Life 75 years
 Anchor Bar Resistance Factor 0.6 (Based on FHWA, June 1999, Table 9)

Description	Avalanche Velocity (m/s)	Forces on Foundation Anchors		Borehole Diameter		Estimated Load Transfer		Minimum Required Anchor Bond Length (In Rock Largely Free of Fissures)		Min. Required Anchor Diameter/Type to Achieve 75-Year Design Life Grade 75 (ASTM A615)	
		Horizontal (kN)	Vertical (kN)	Horizontal (mm)	Vertical (mm)	Horizontal (kN/m)	Vertical (kN/m)	Horizontal (m)	Vertical (m)	Horizontal (Bar Size)	Vertical (Bar Size)
Factored load	18	312	146	76	63.5	151	126	4.13	2.31	43	32

Bar designation	Grade 75						Grade 80
	#6	#7	#8	#9	#10	#11	#14
Starting diameter (mm)	19	22	25	29	32	36	43
Initial minimum yield stress (Mpa)	517	517	517	517	517	517	552
Nominal cross sectional area (mm ²)	284	387	510	645	819	1006	1452
Initial minimum yield load (kN)	147	200	264	334	424	520	801
Service life (years)	75	75	75	75	75	75	75
Loss of steel (mm)	2.53	2.53	2.53	2.53	2.53	2.53	2.53
Loss of steel both sides (mm)	5.06	5.06	5.06	5.11	5.06	5.06	5.06
End diameter (mm)	13.94	16.94	19.94	23.89	26.94	30.94	37.94
End area (mm ²)	153	225	312	448	570	752	1131
Reduced tensile yield capacity (kN)	79	117	161	232	295	389	624
Factored resistance 0.6 (kN)	47	70	97	139	177	233	374

Notes

- Based on NCHRP (2011), Loss of steel in 75 years:
 $X (mm) = 80 \times t^{0.8}$
- DYWIDAG threadbar properties