

PLOT DATE: 2026/03/12 N:\HWY DESIGN and SURVEY\Design\Projects\SIR\OSD_RiceBridge\0643_2022_(25757)\00-C3D\DesignModel\03_Corridors\100A\SECT - 25757.dwg

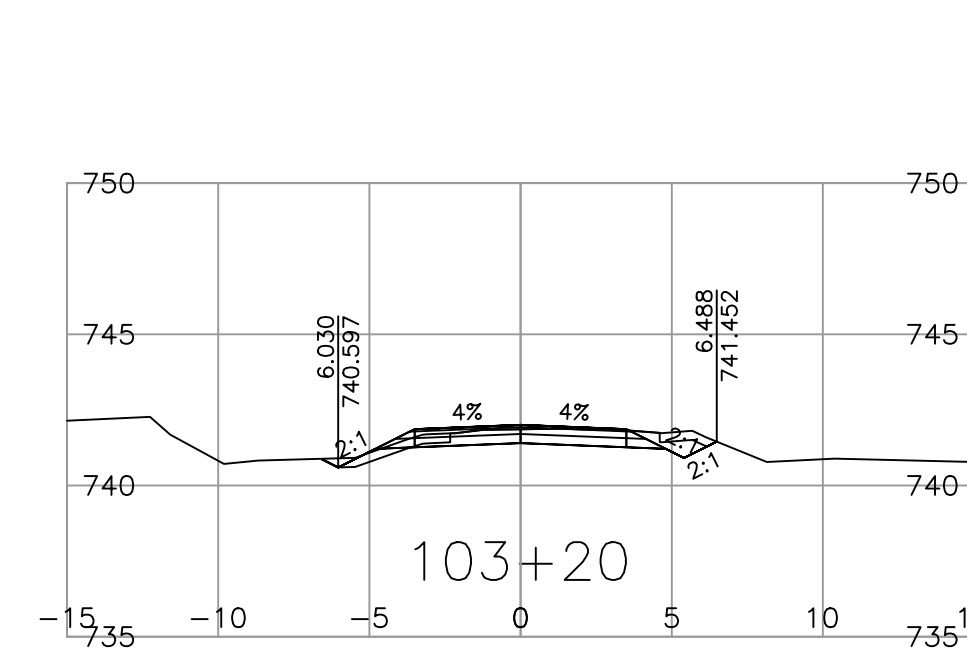
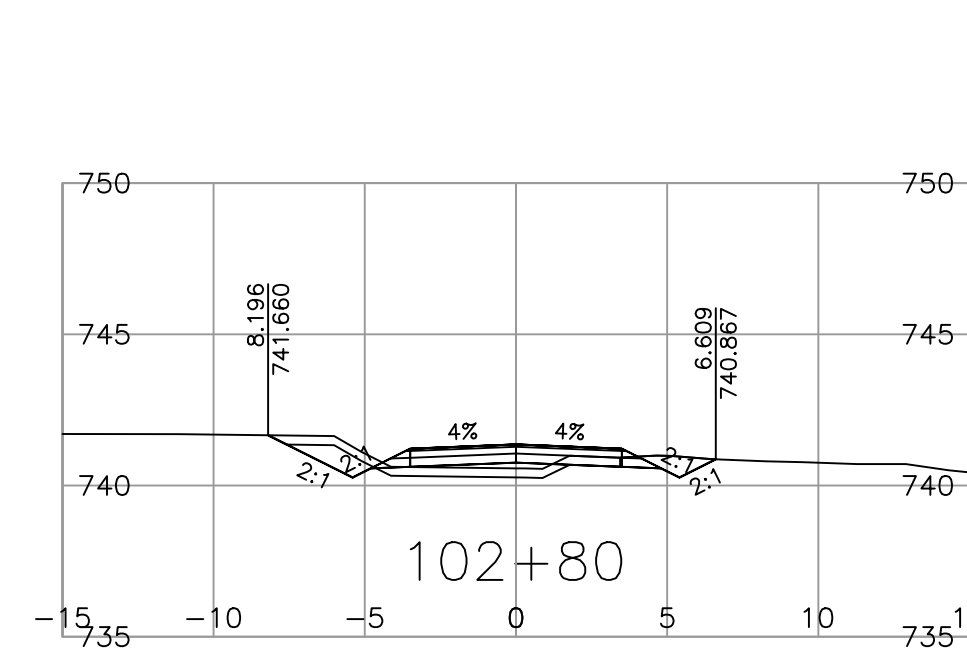
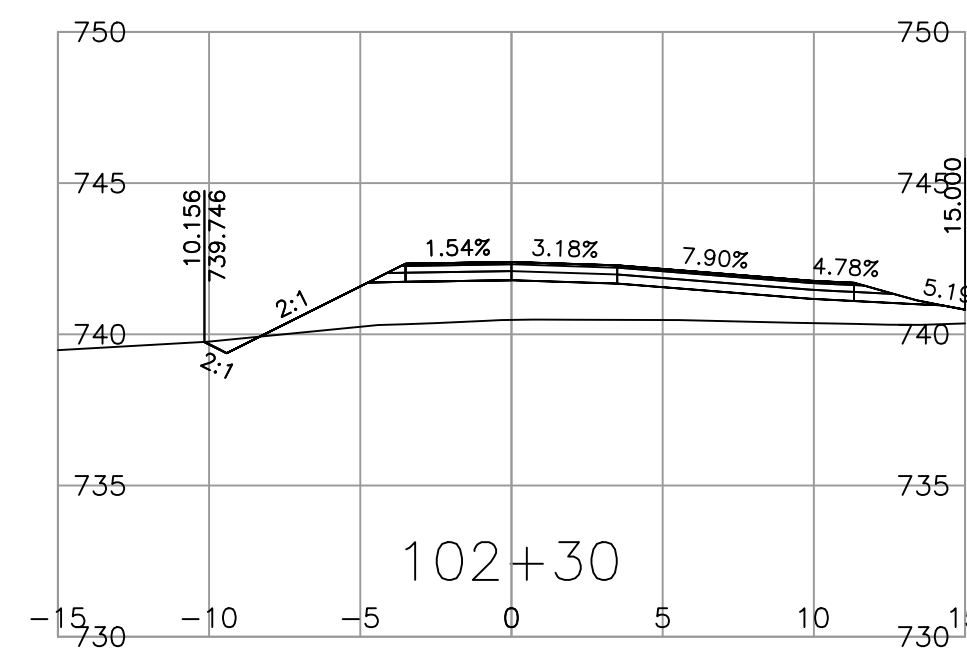
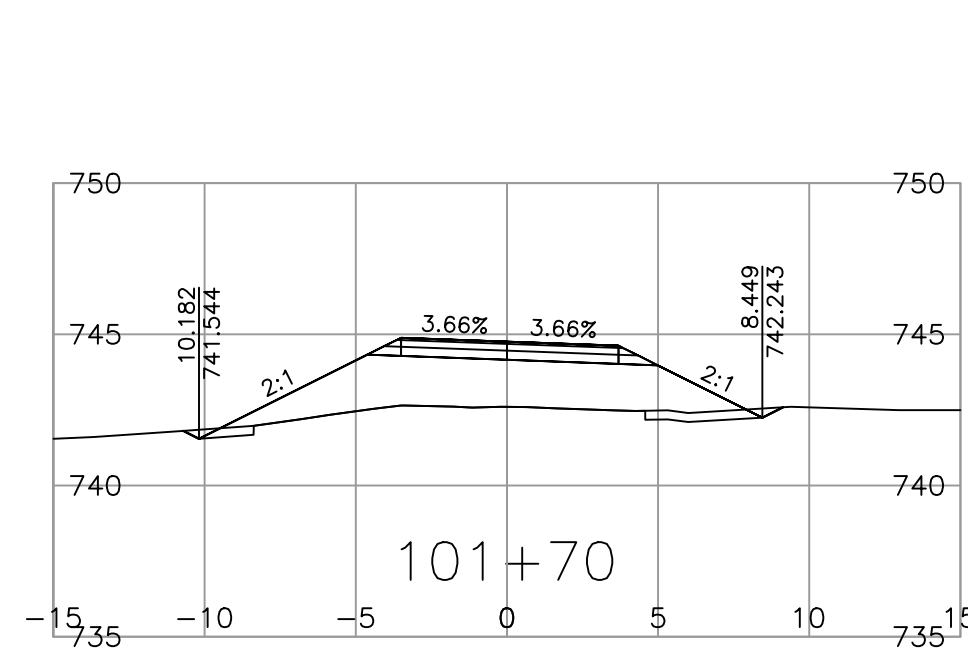
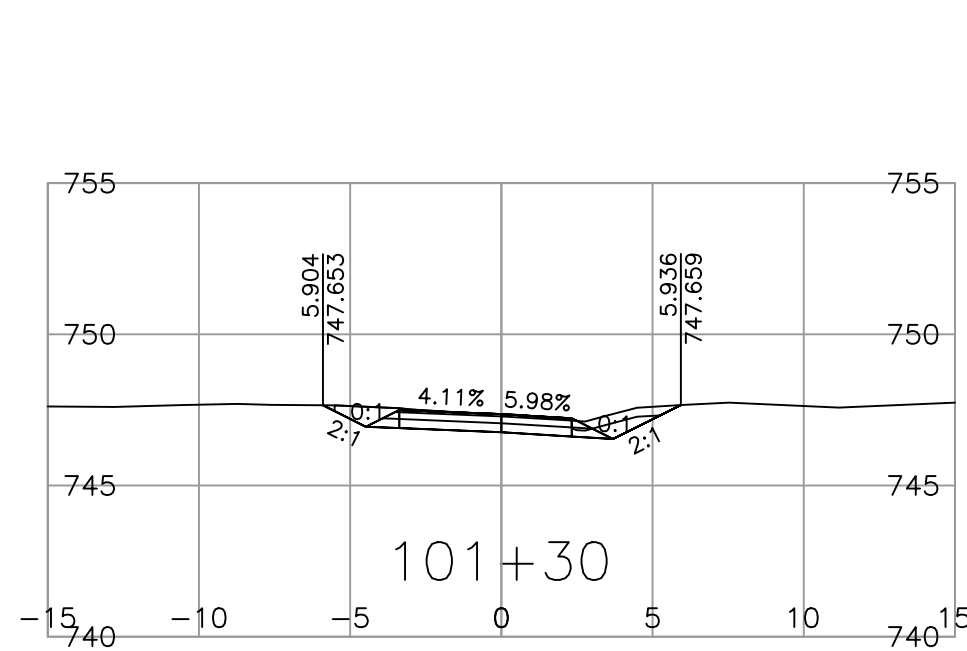
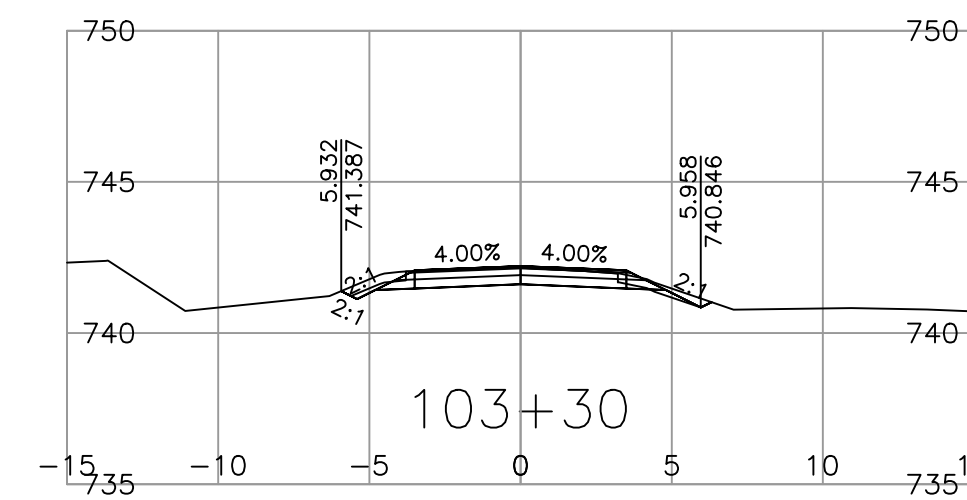
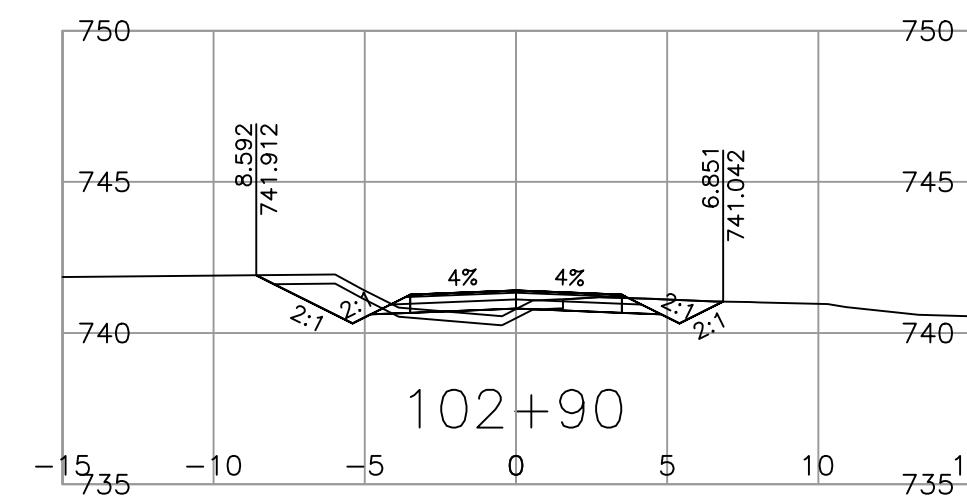
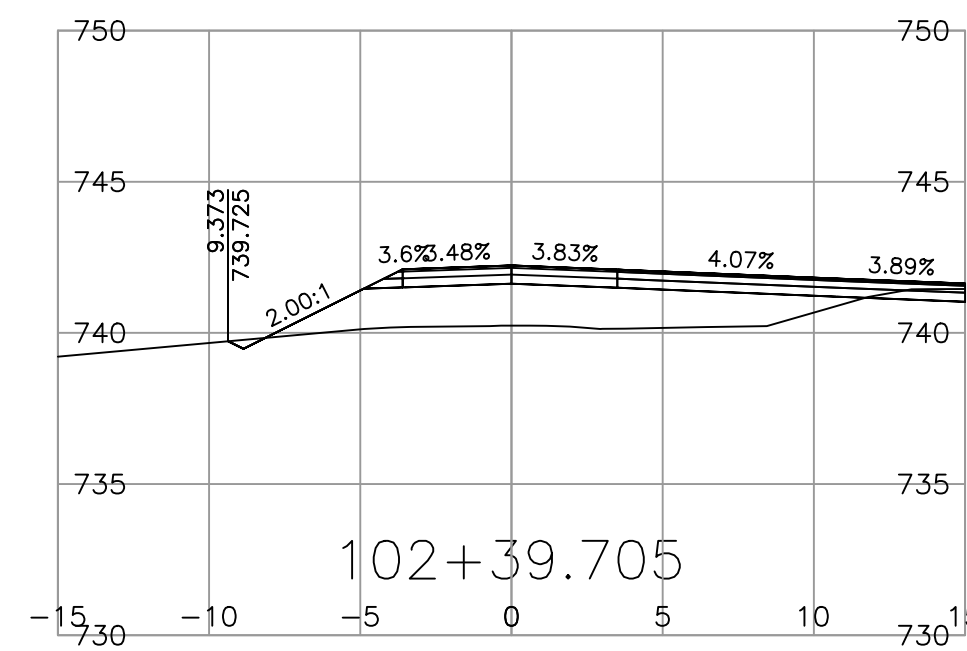
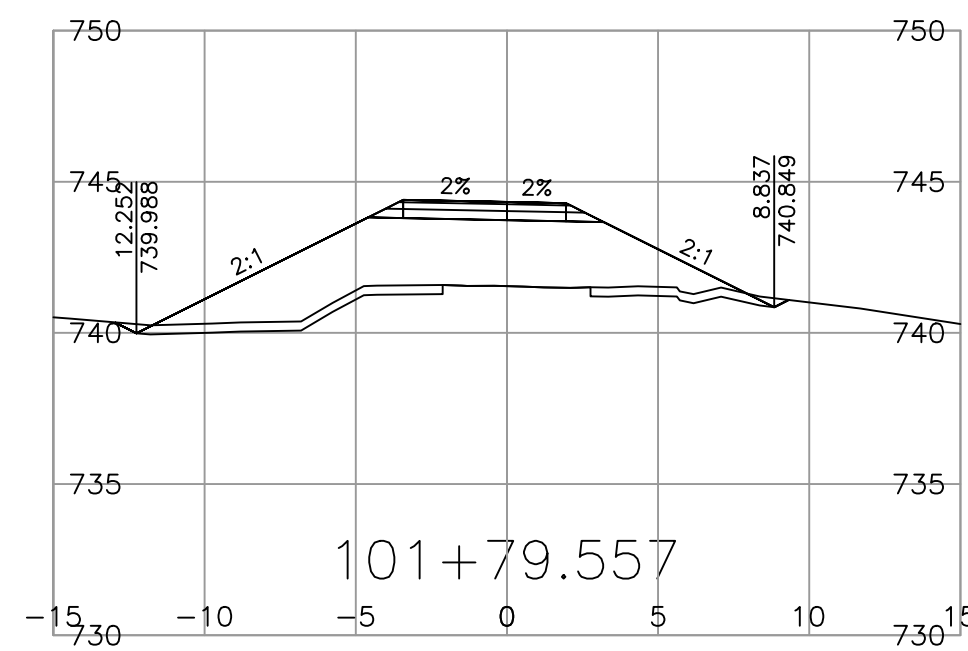
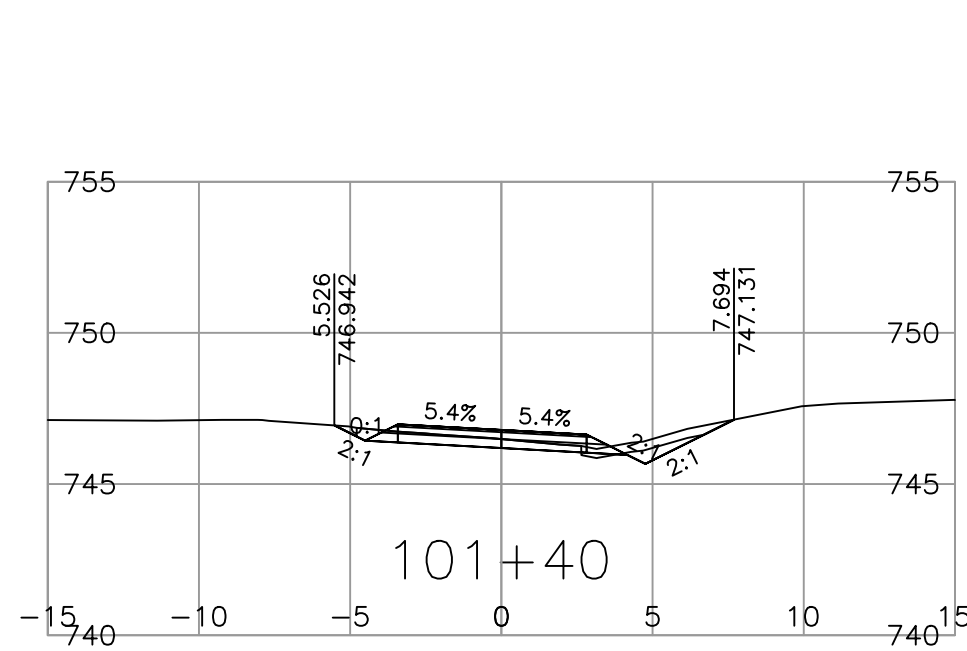
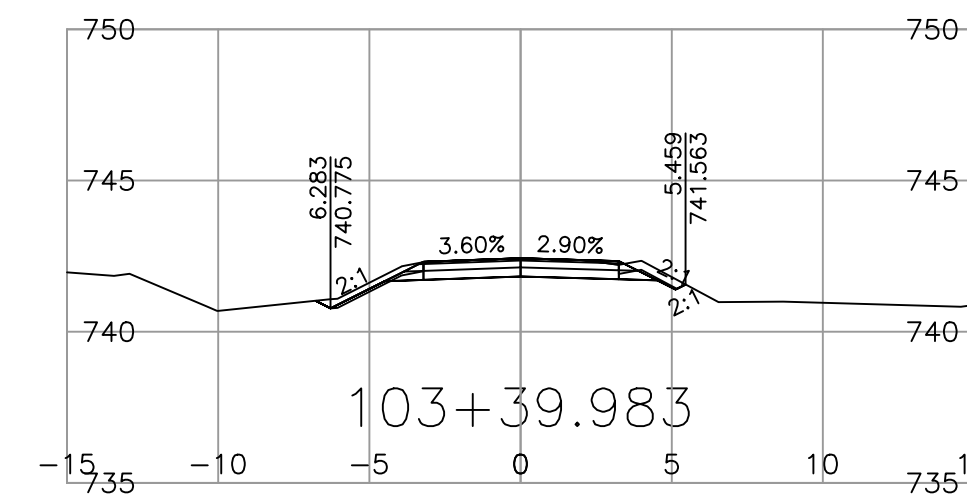
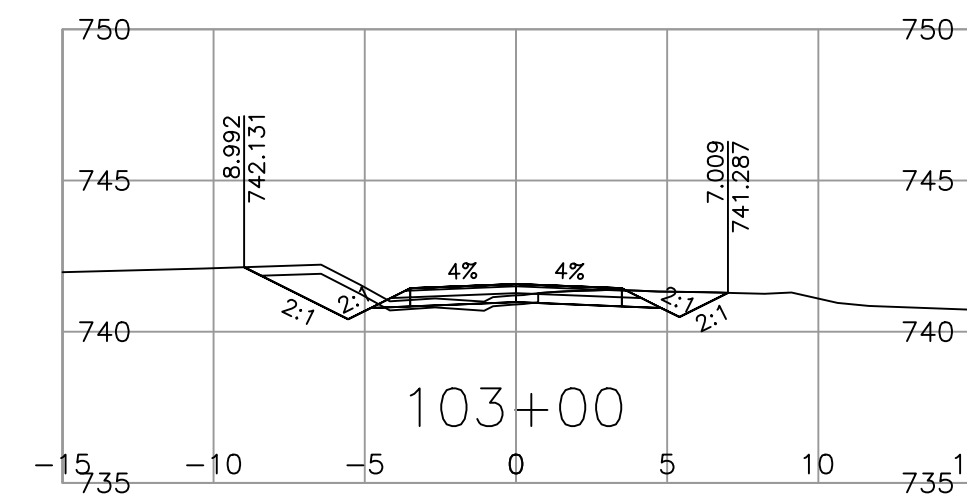
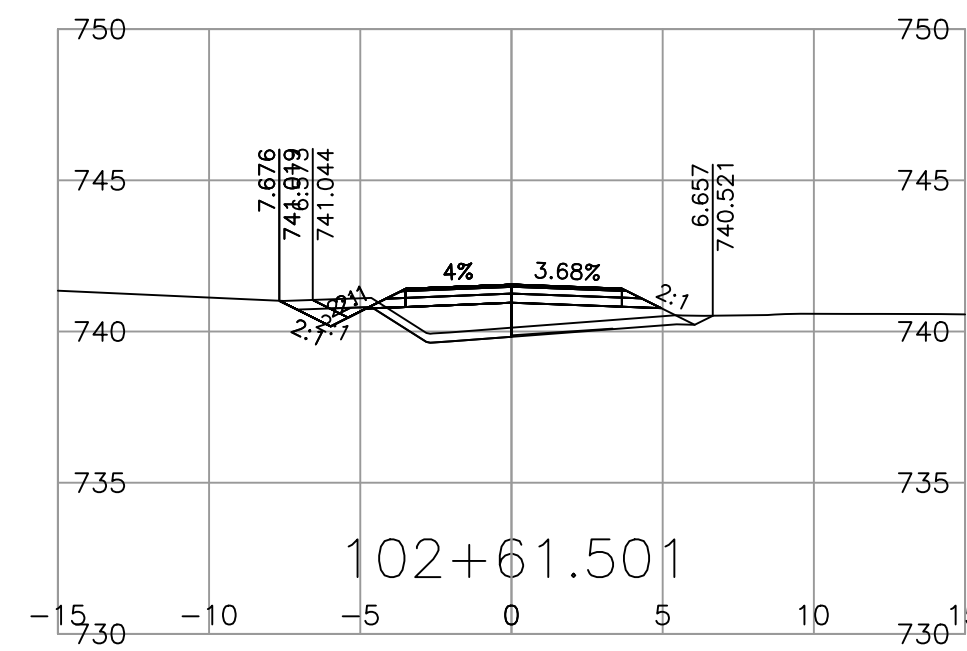
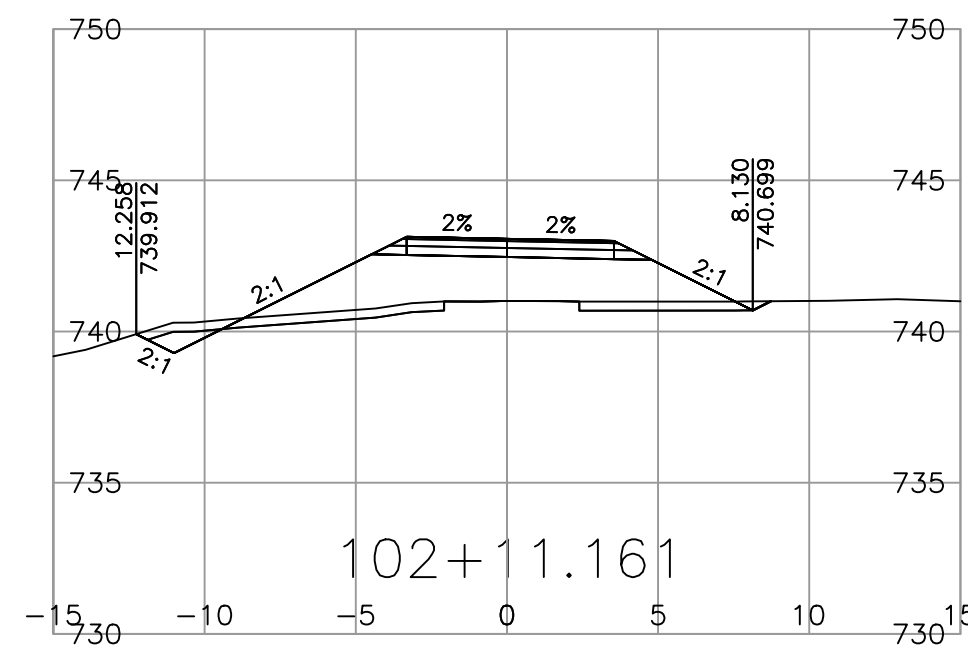
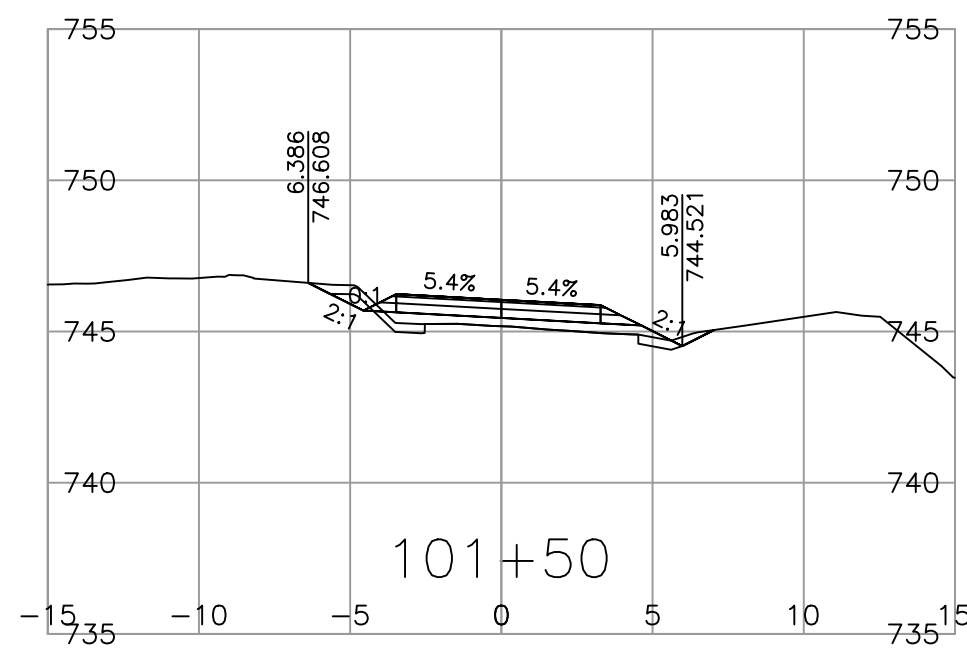
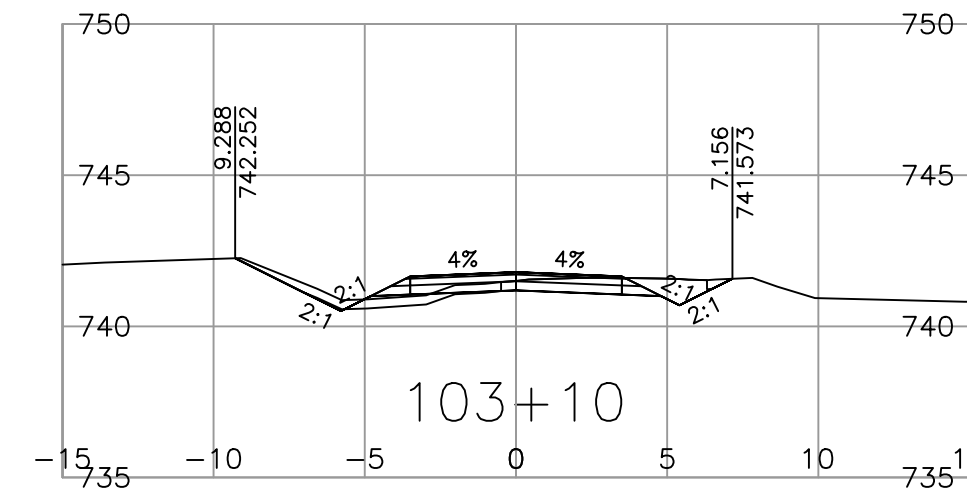
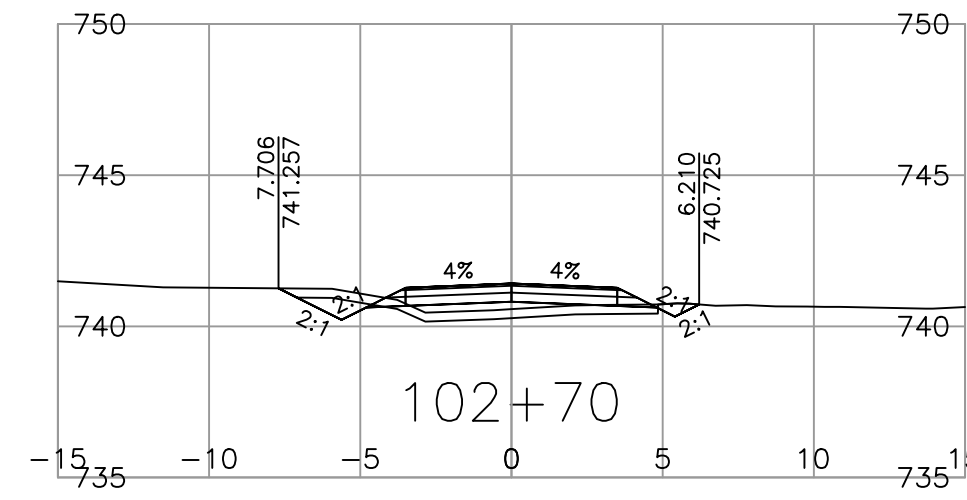
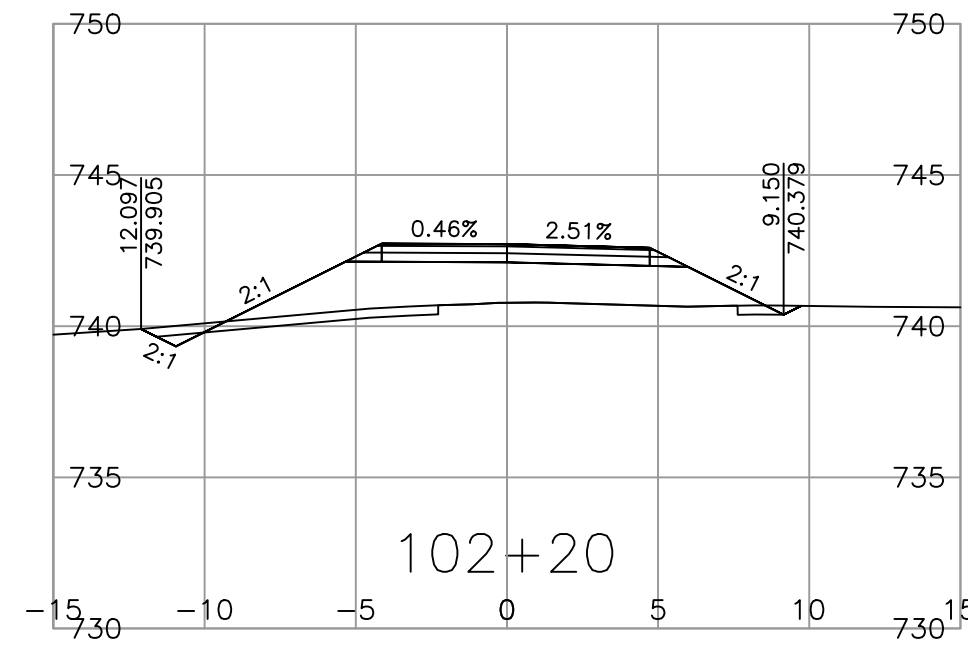
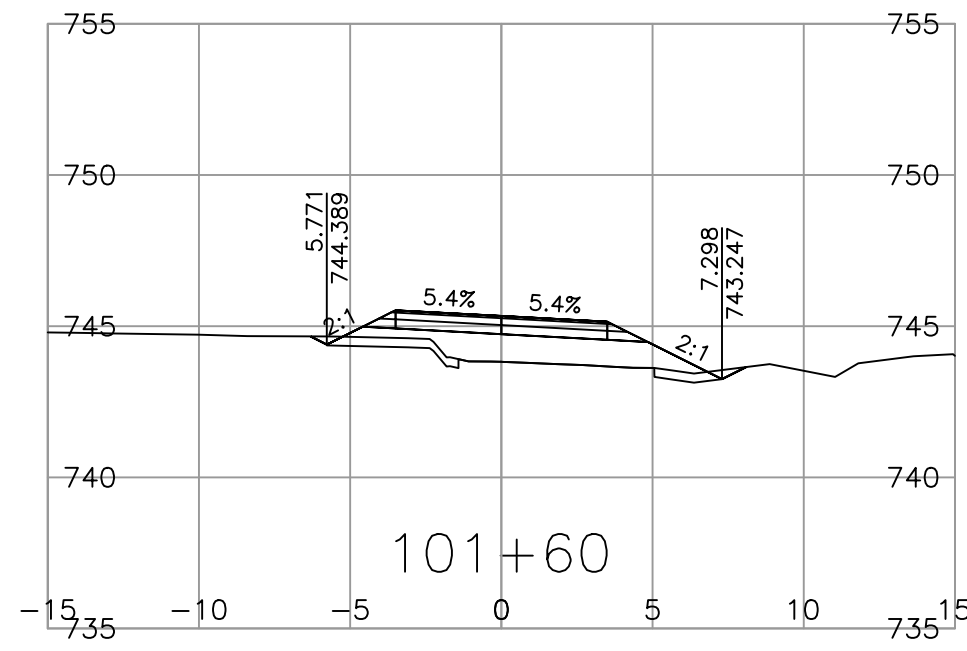

SCALE 0 2 1:250 12m

CAD FILENAME L100A\SECT - 25757
PLOT DATE 2026-03-12

REV	DATE	REVISIONS	NAME

BRITISH COLUMBIA
MINISTRY OF TRANSPORTATION AND INFRASTRUCTURE
SOUTHERN INTERIOR REGION
HIGHWAY ENGINEERING AND GEOMATICS

DESIGNED J.BRAND DATE 2026-03-12
QUALITY CONTROL M.DIDONATO DATE 2026-03-12
QUALITY ASSURANCE DATE
DRAWN J.BRAND DATE 2026-03-12

SENIOR DESIGNER
DATE 2026-03-12

DESIGN SECTIONS
RICE ROAD BRIDGE REPLACEMENT

STA. 101+30.000 TO 103+39.983

FILE NUMBER	PROJECT NUMBER	REG	DRAWING NUMBER	REV
-	25757-0000	2	R2-1220-1001	.

PLOT DATE: 2026/03/12 N:\HWY DESIGN and SURVEY\Projects\SIR\OSD_RiceBridge\6543_2022_(25757)\00-CSD\DesignModel\03_Corridors\100A\SECT - 25757.dwg

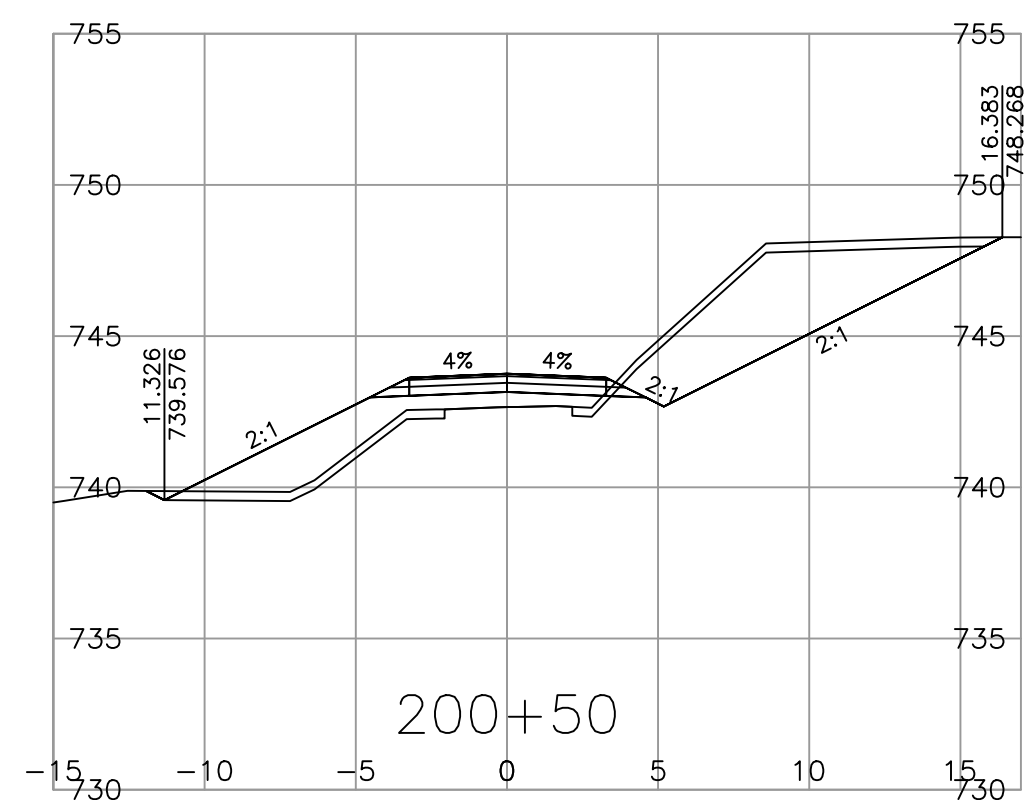
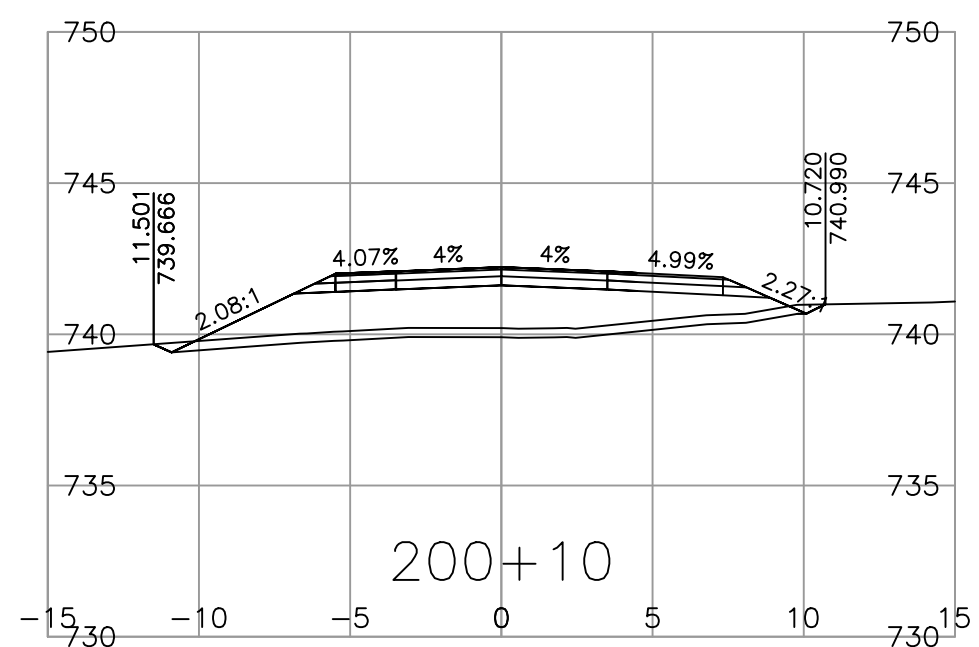
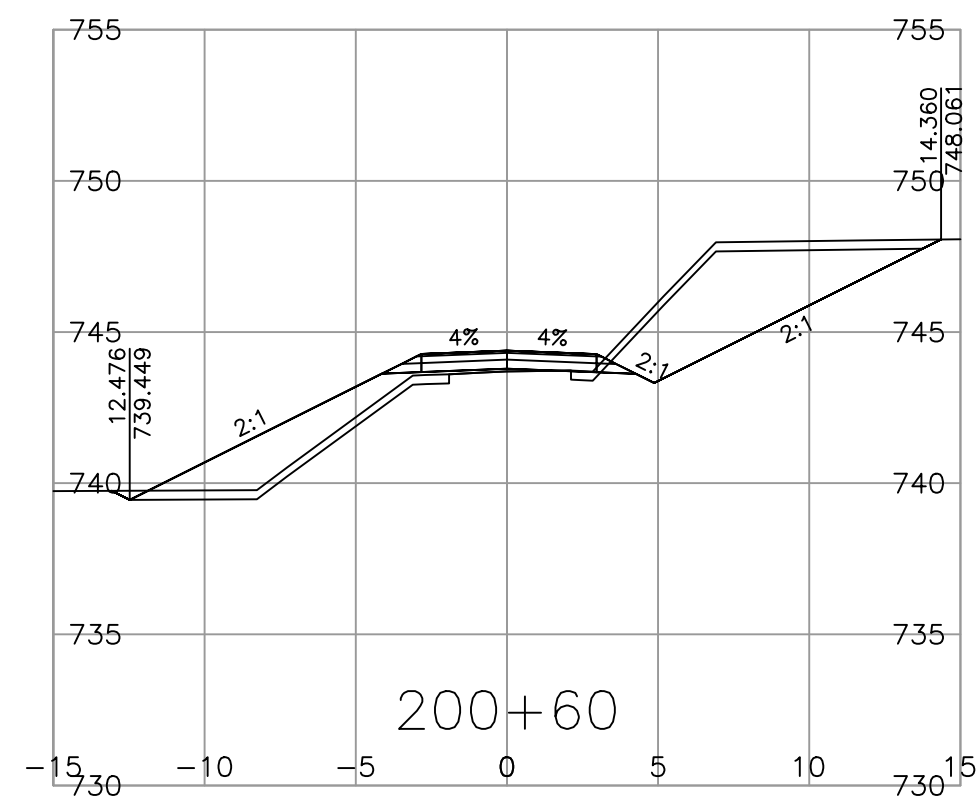
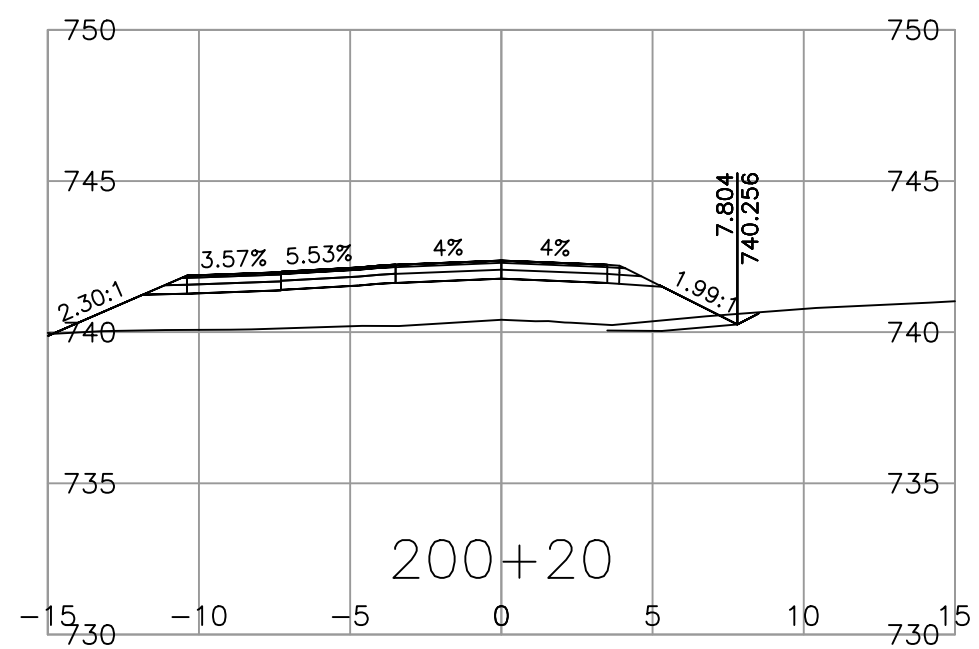
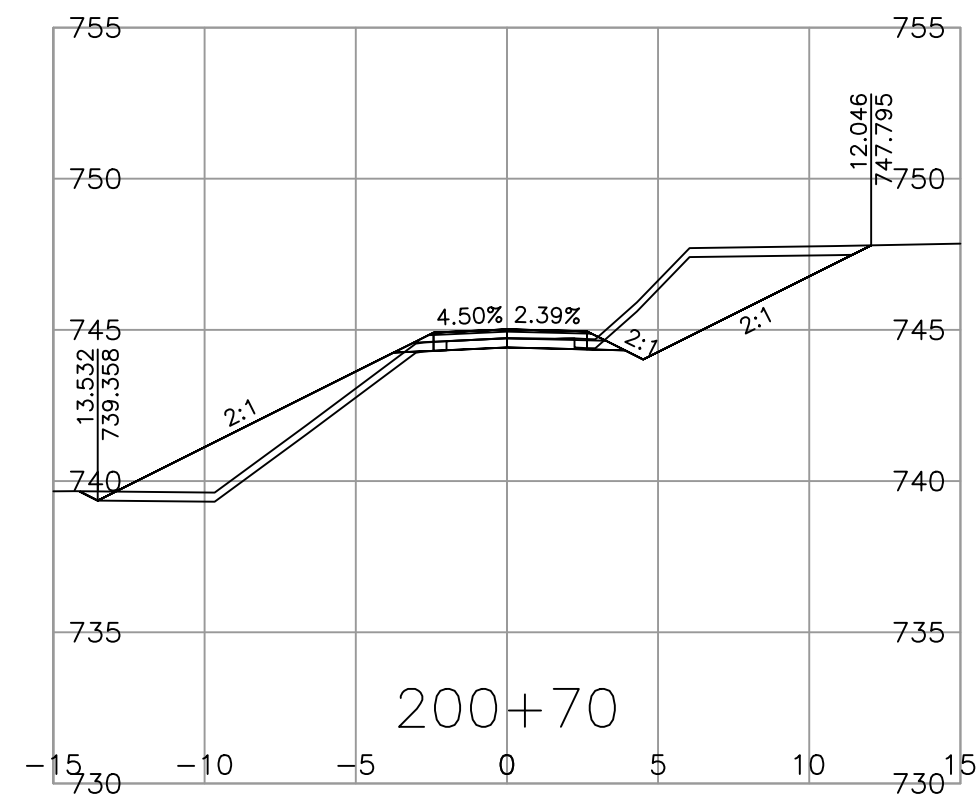
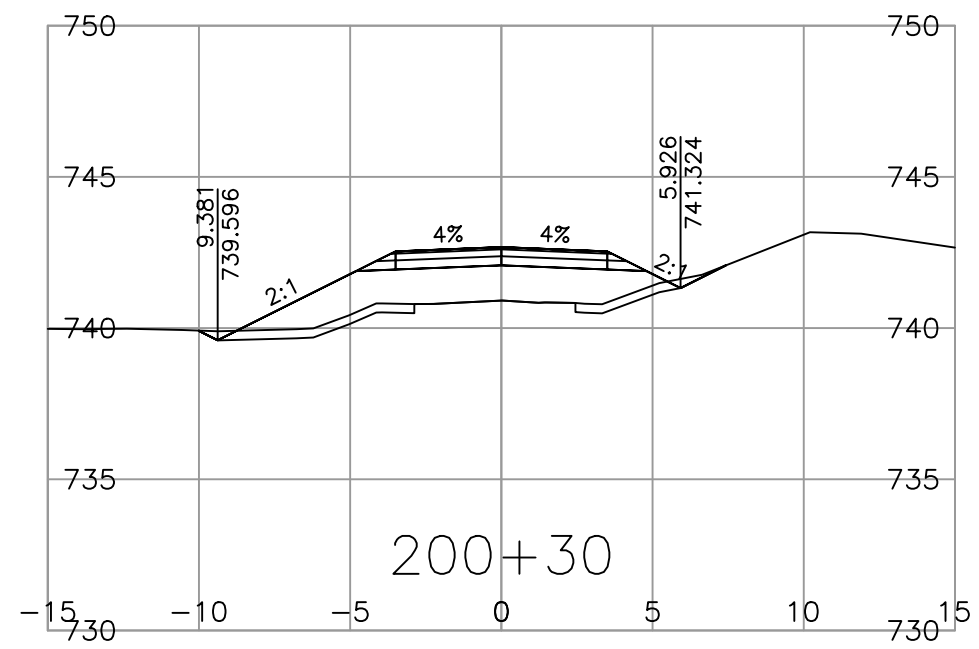
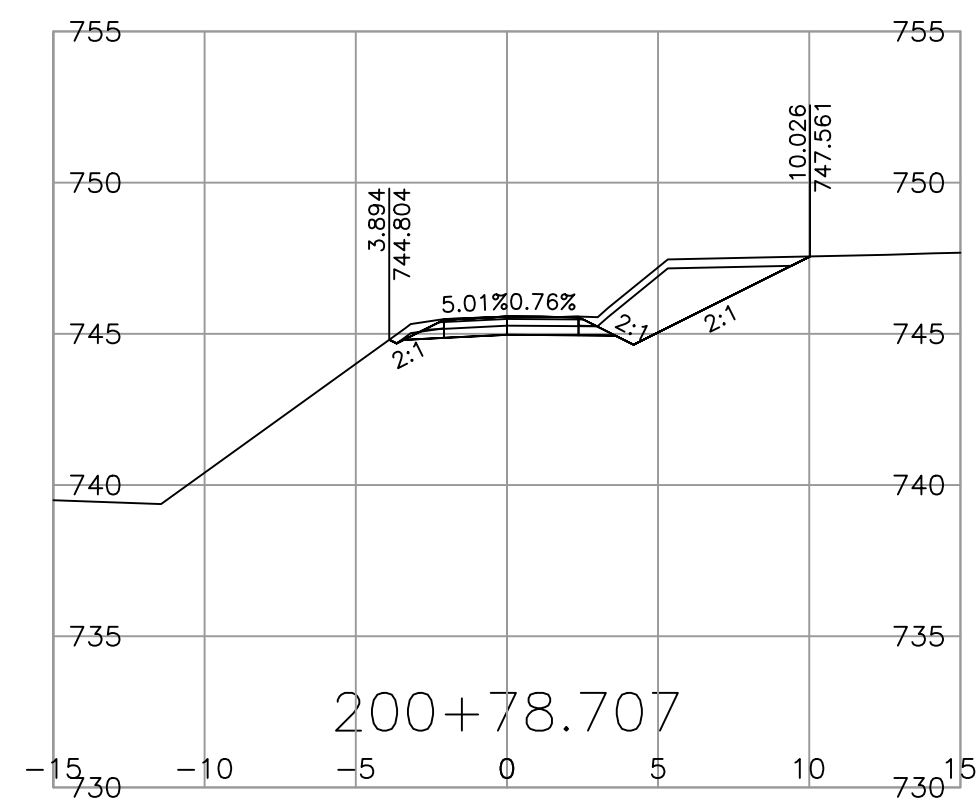
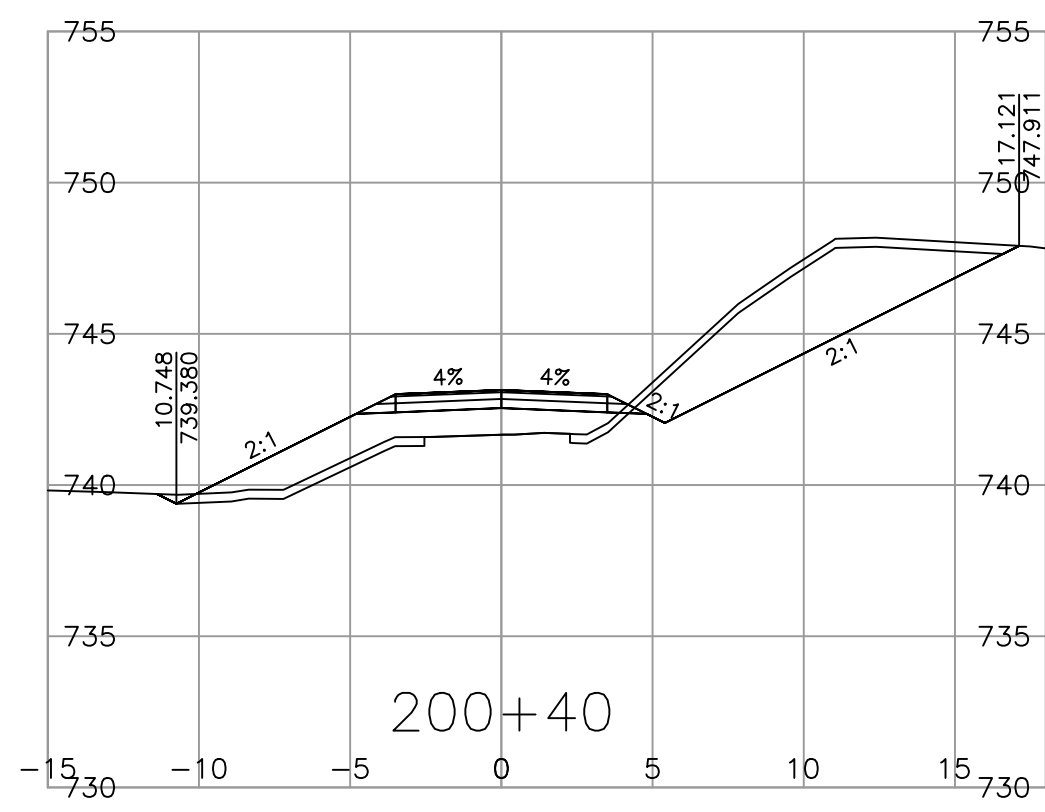

SCALE 0 2 1:250 12m

CAD FILENAME L100A\SECT - 25757
PLOT DATE 2026-03-12

REV	DATE	REVISIONS	NAME

BRITISH COLUMBIA

MINISTRY OF TRANSPORTATION AND INFRASTRUCTURE
SOUTHERN INTERIOR REGION
HIGHWAY ENGINEERING AND GEOMATICS

DESIGNED J.BRAND DATE 2026-03-12
QUALITY CONTROL M.DIDONATO DATE 2026-03-12
QUALITY ASSURANCE DATE
DRAWN J.BRAND DATE 2026-03-12

SENIOR DESIGNER
DATE 2026-03-12

DESIGN SECTIONS				
RICE ROAD BRIDGE REPLACEMENT				
STA. 200+10.000 TO 200+78.707				
FILE NUMBER	PROJECT NUMBER	REG	DRAWING NUMBER	REV
-	25757-0000	2	R2-1220-1002	.

PLOT DATE: 2026/03/12 N:\HWY DESIGN and SURVEY\Design\Projects\SIR\OSD_RiceBridgeNo6543_2022_(25757)\00-C3D\DesignModel\03_Corridors\100A\SECT - 25757.dwg

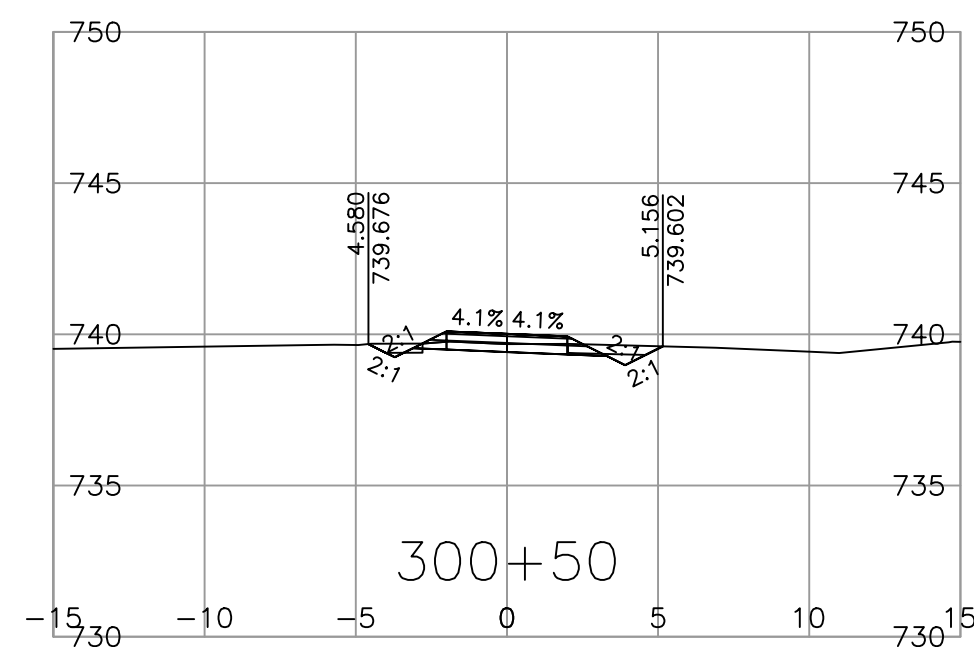
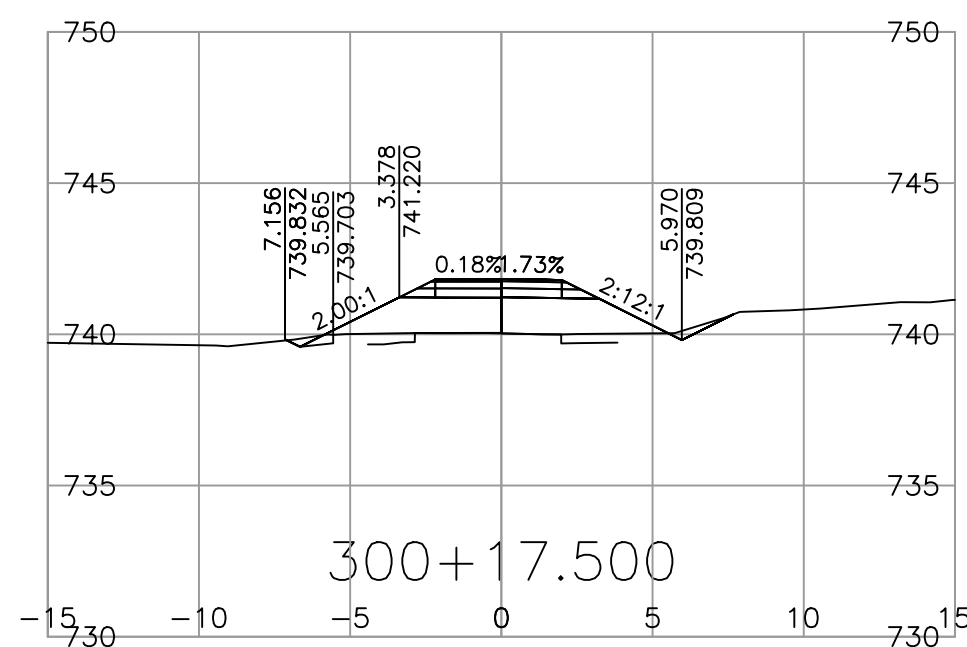
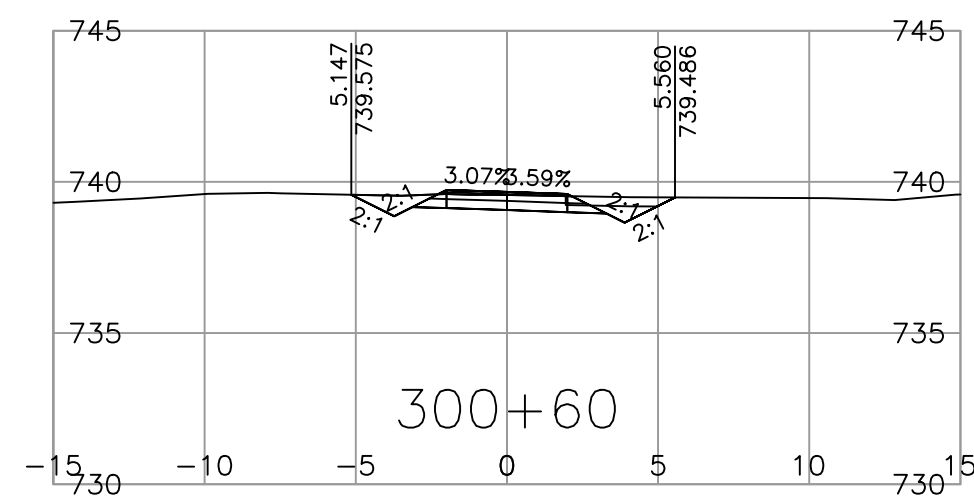
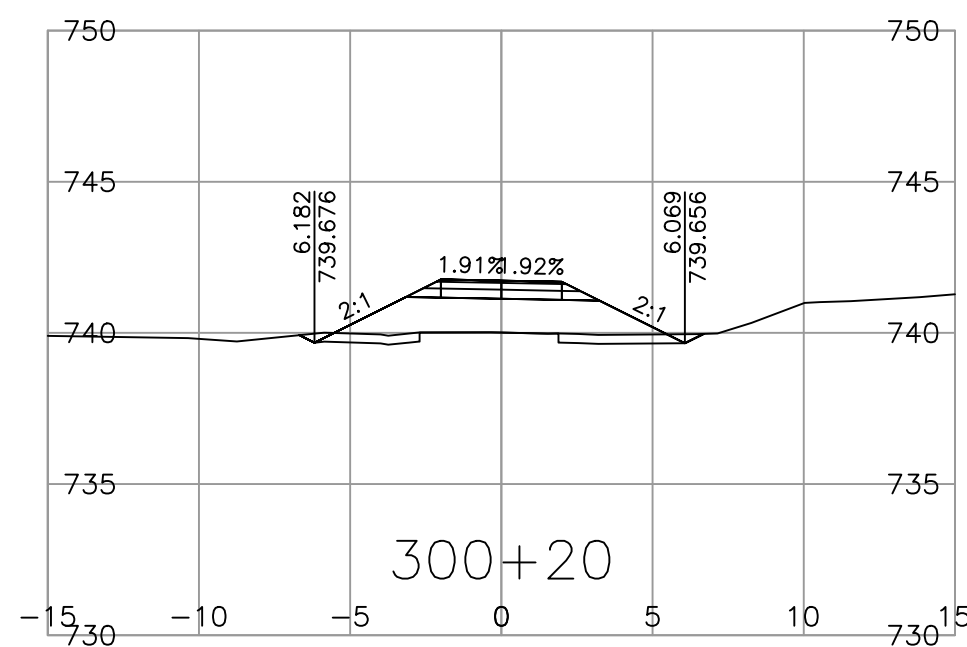
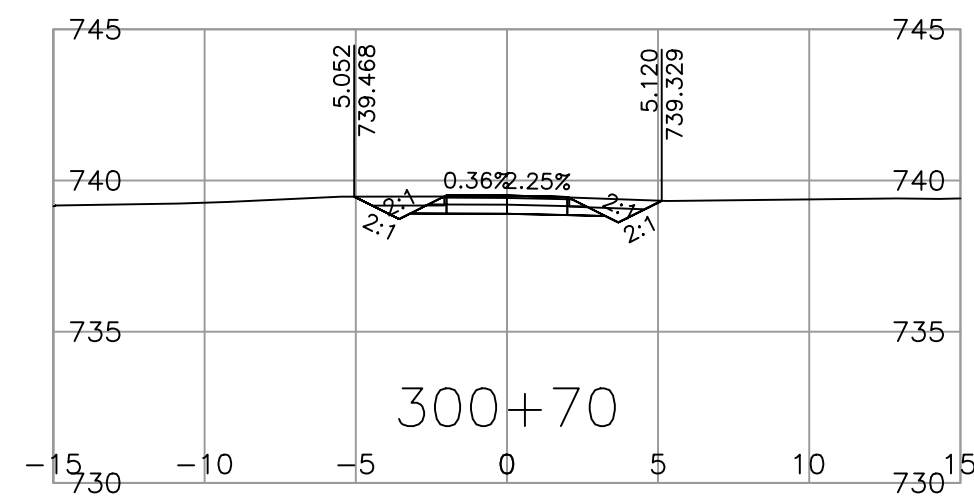
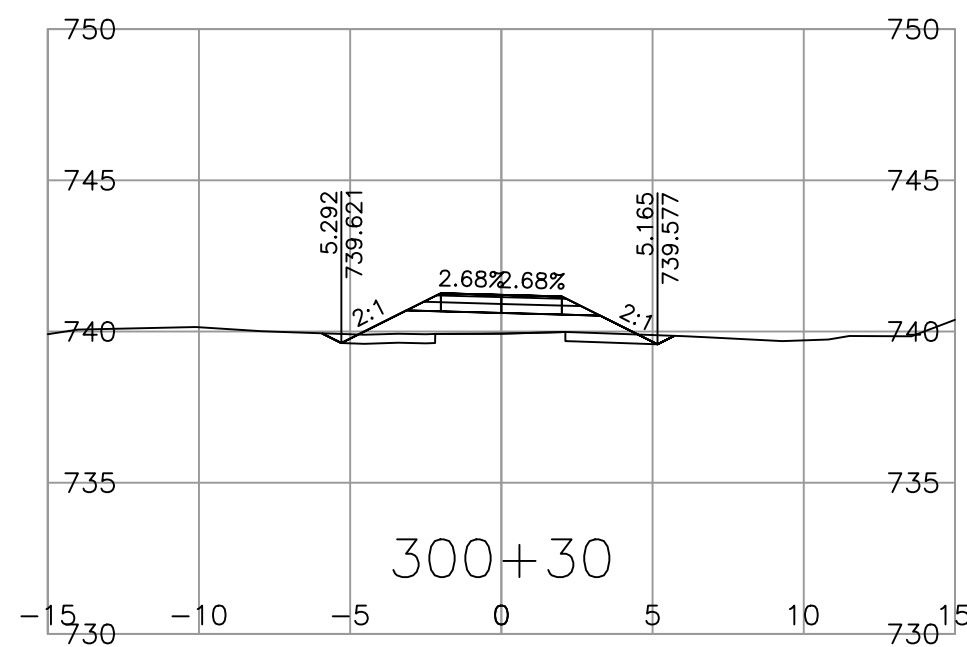
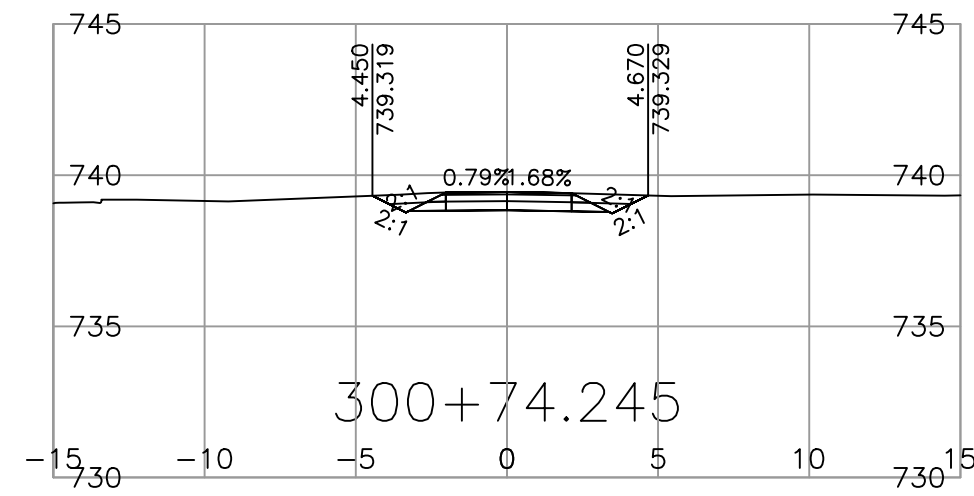
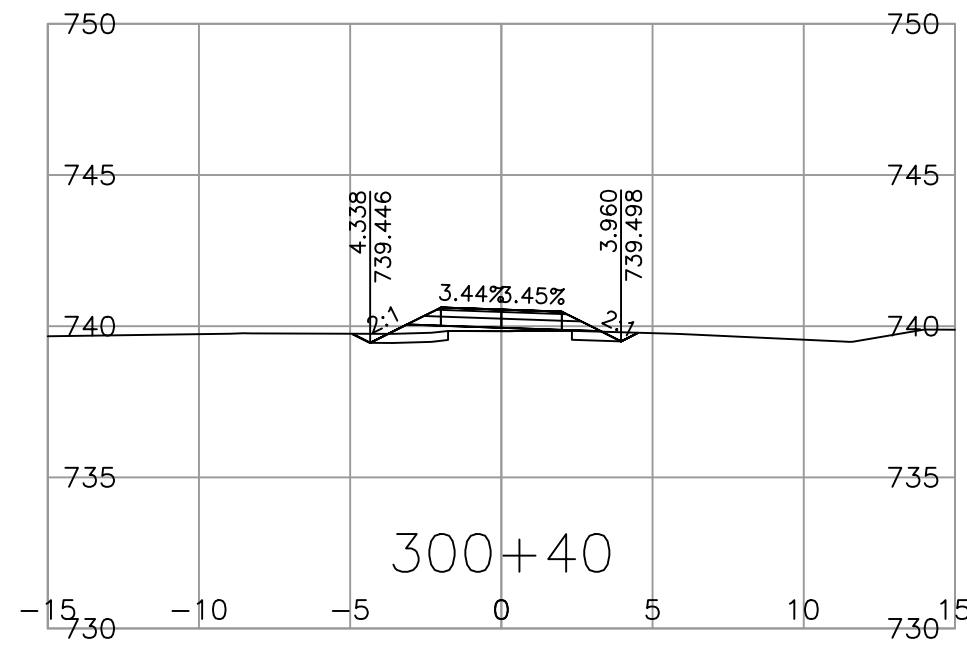

SCALE 0 2 1:250 12m

CAD FILENAME L100A\SECT - 25757
PLOT DATE 2026-03-12

REV	DATE	REVISIONS	NAME

BRITISH COLUMBIA

MINISTRY OF TRANSPORTATION AND INFRASTRUCTURE
SOUTHERN INTERIOR REGION
HIGHWAY ENGINEERING AND GEOMATICS

DESIGNED J.BRAND DATE 2026-03-12
QUALITY CONTROL M.DIDONATO DATE 2026-03-12
QUALITY ASSURANCE - DATE -
DRAWN J.BRAND DATE 2026-03-12

SENIOR DESIGNER _____
DATE 2026-03-12

DESIGN SECTIONS				
RICE ROAD BRIDGE REPLACEMENT				
STA. 300+17.500 TO 300+74.245				
FILE NUMBER	PROJECT NUMBER	REG	DRAWING NUMBER	REV
-	25757-0000	2	R2-1220-1003	.

PLOT DATE: 2026/03/12 N:\HWY DESIGN and SURVEY\Design\Projects\SIR\OSD_RiceBridgeNo6543_2022_(25757)\00-C3D\DesignModel\03_Corridors\L100A\SECT - 25757.dwg

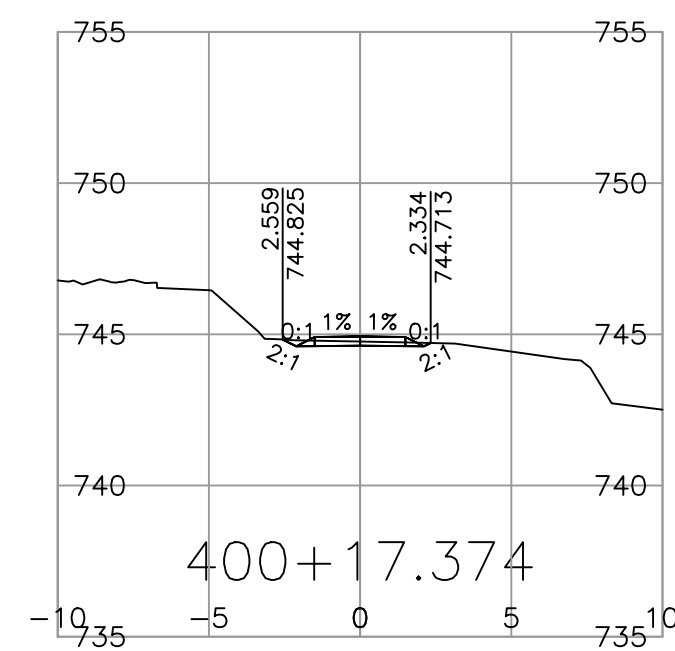
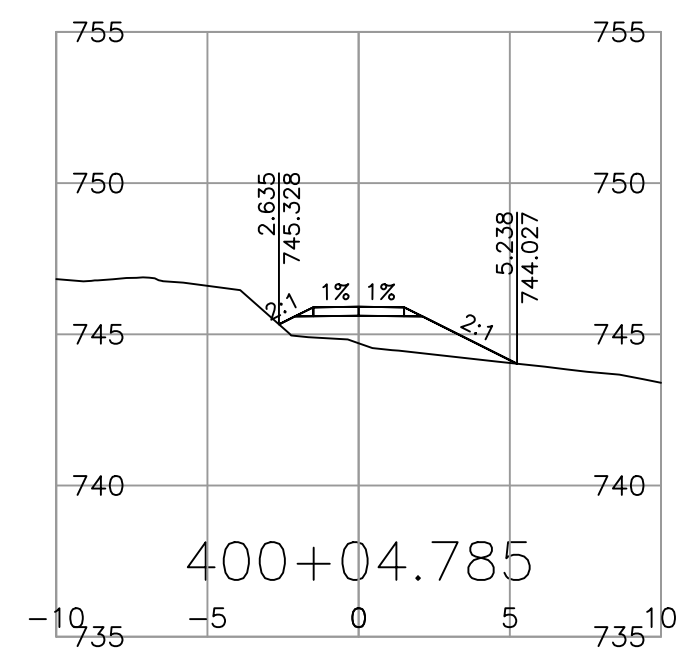
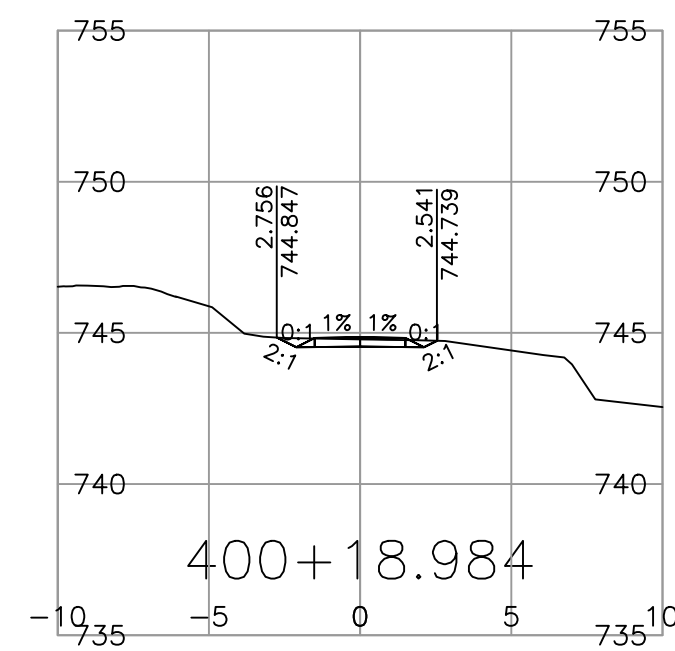
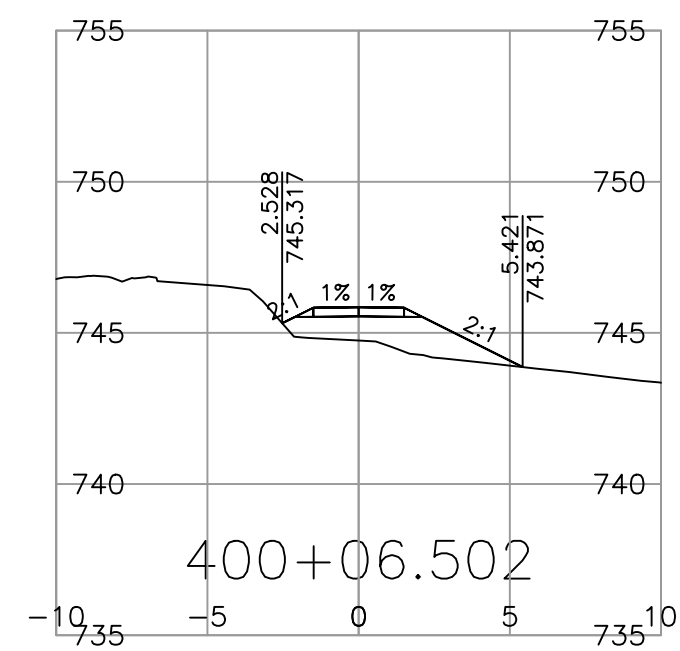
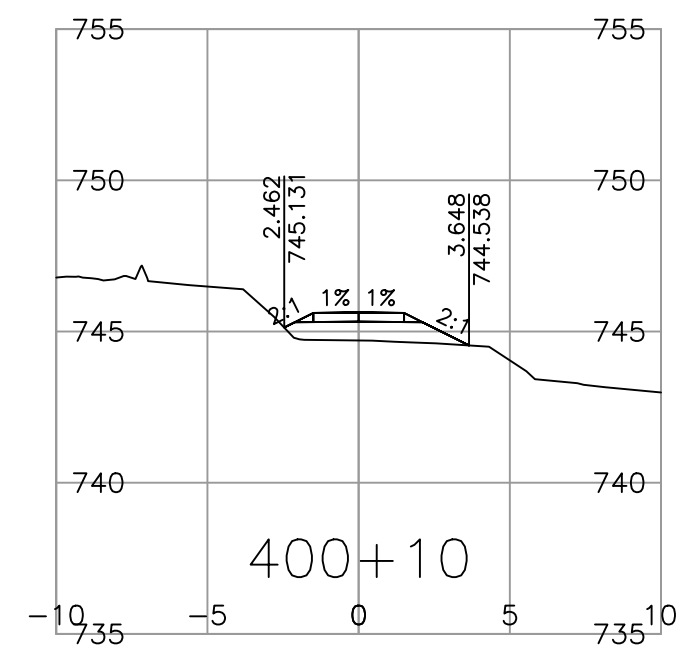
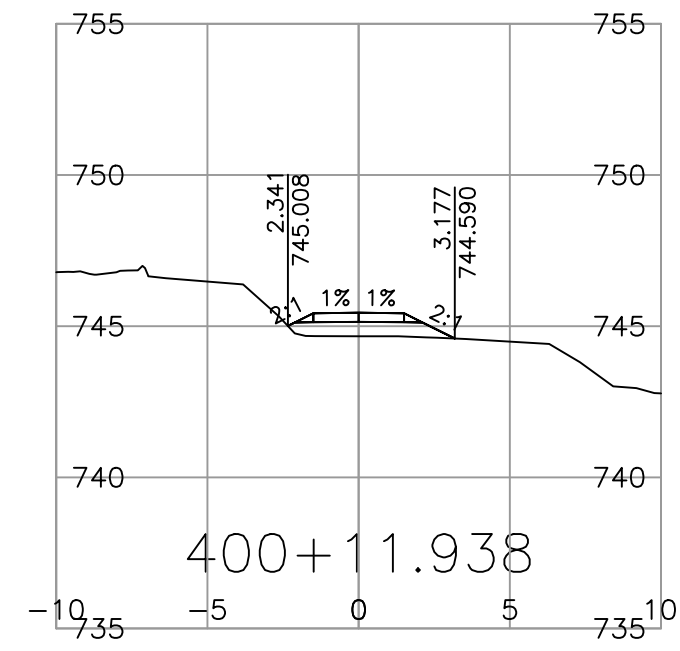

SCALE 0 2 1:250 12m

CAD FILENAME L100A\SECT - 25757
PLOT DATE 2026-03-12

REV	DATE	REVISIONS	NAME

BRITISH COLUMBIA
MINISTRY OF TRANSPORTATION AND INFRASTRUCTURE
SOUTHERN INTERIOR REGION
HIGHWAY ENGINEERING AND GEOMATICS

DESIGNED J.BRAND DATE 2026-03-12
QUALITY CONTROL M.DIDONATO DATE 2026-03-12
QUALITY ASSURANCE - DATE -
DRAWN J.BRAND DATE 2026-03-12

SENIOR DESIGNER _____
DATE 2026-03-12

DESIGN SECTIONS				
RICE ROAD BRIDGE REPLACEMENT				
STA. 400+04.785 TO 400+18.984				
FILE NUMBER	PROJECT NUMBER	REG	DRAWING NUMBER	REV
-	25757-0000	2	R2-1220-1004	.