

PRINTED: September 28, 2023 - 4:12 PM
 CAD FILE: X:\212100865-09\101- Canal Road Remediatio10.0 Drawings\10.3 Engineering\CanalRoad\DrawingProduction\1003_Design\SectionR1-1025-1000.dwg (LAST SAVED: Gharoon)

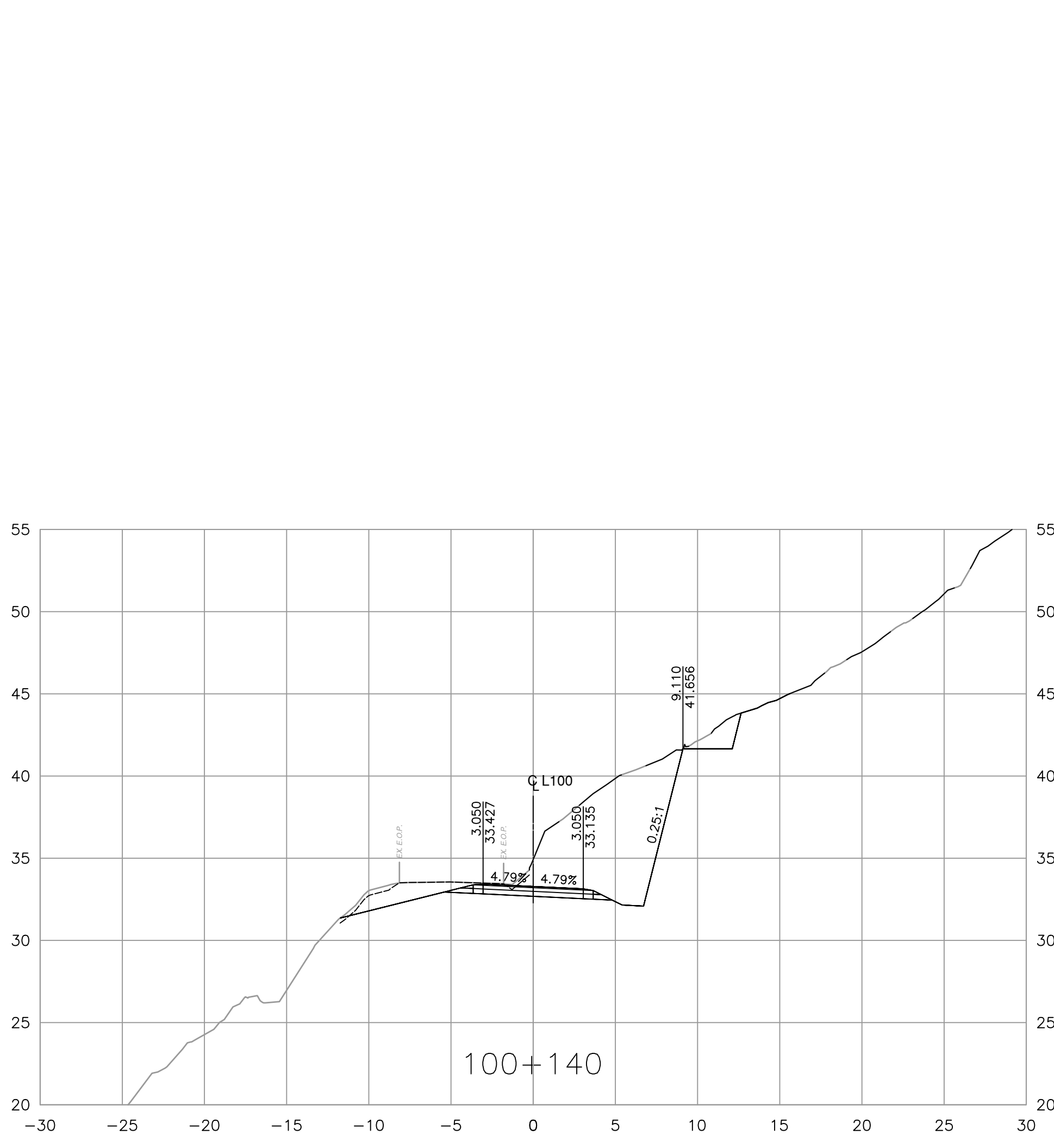

FOR REFERENCE ONLY

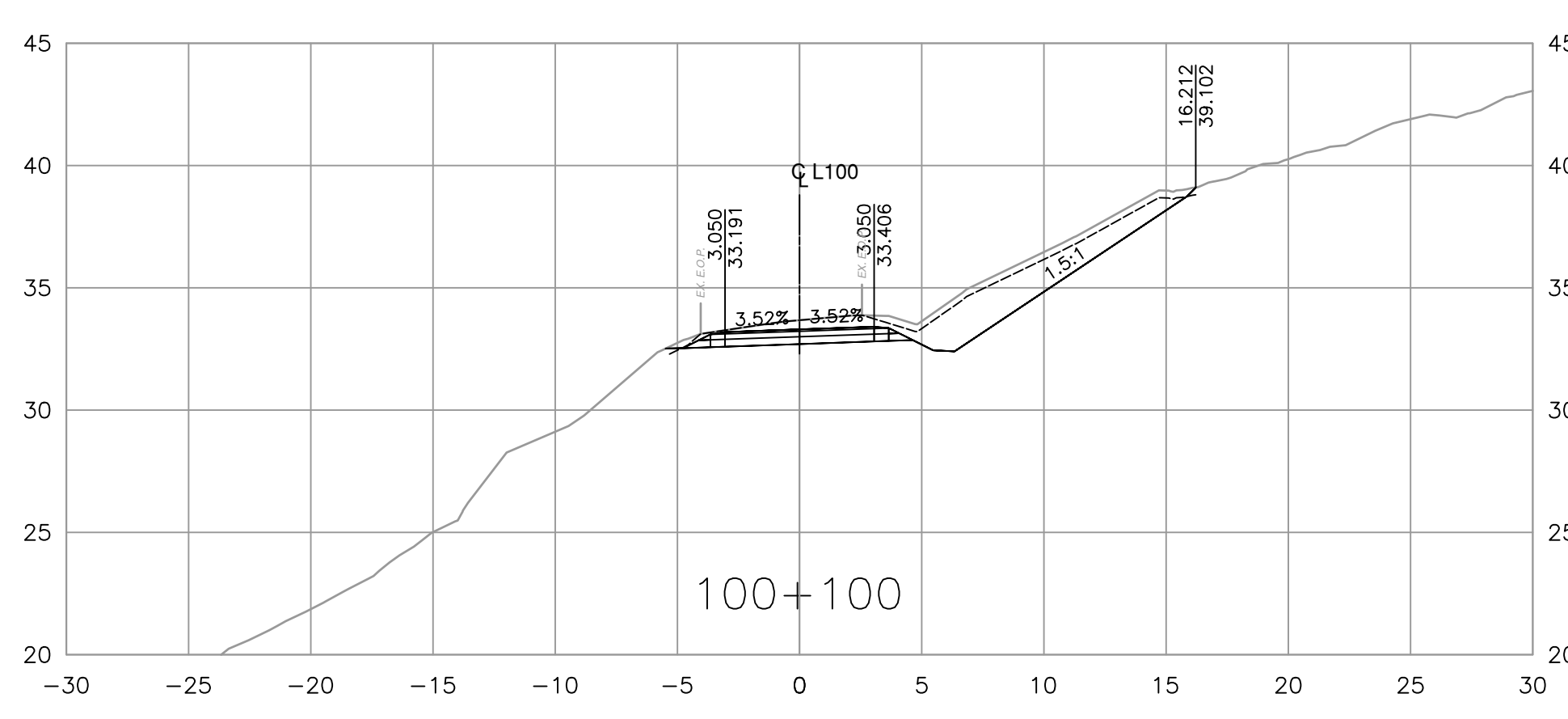
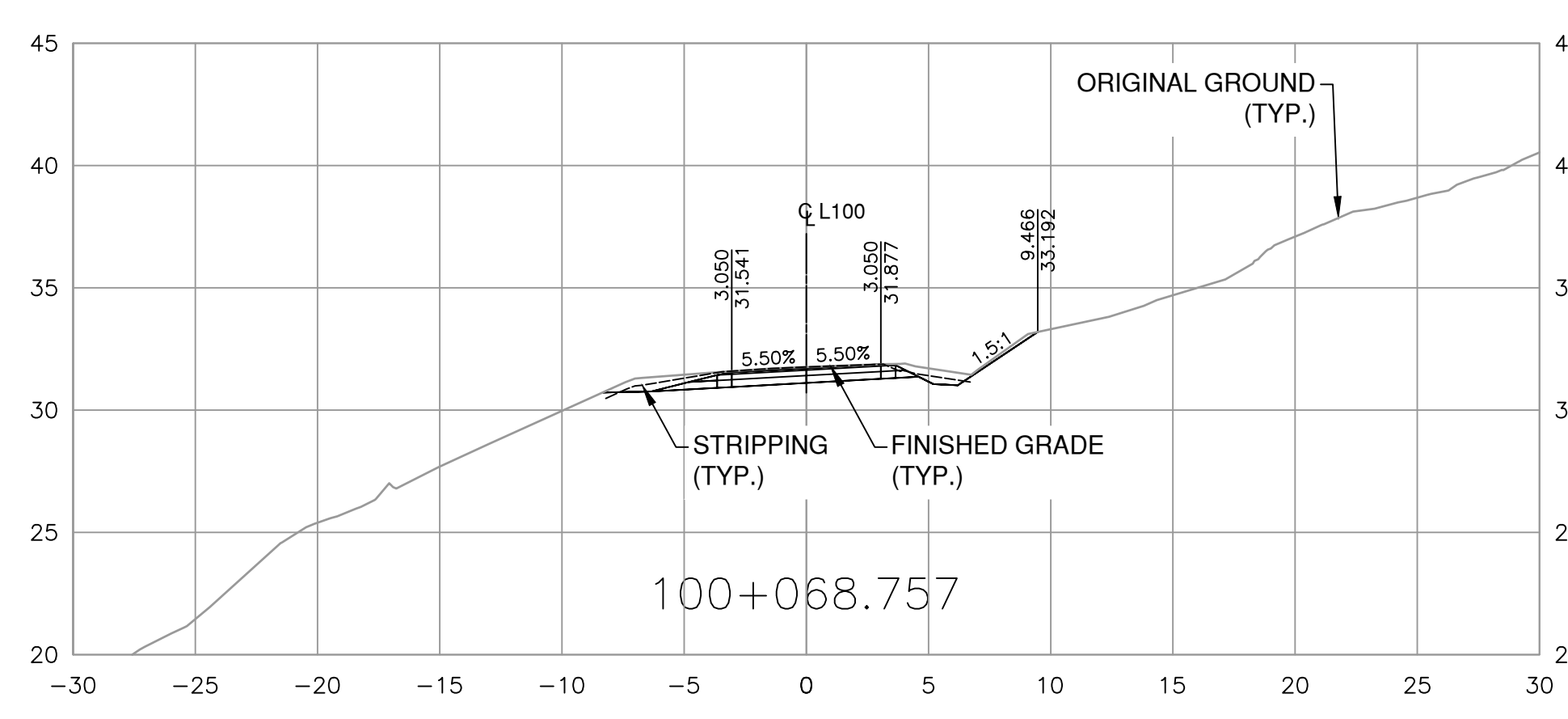
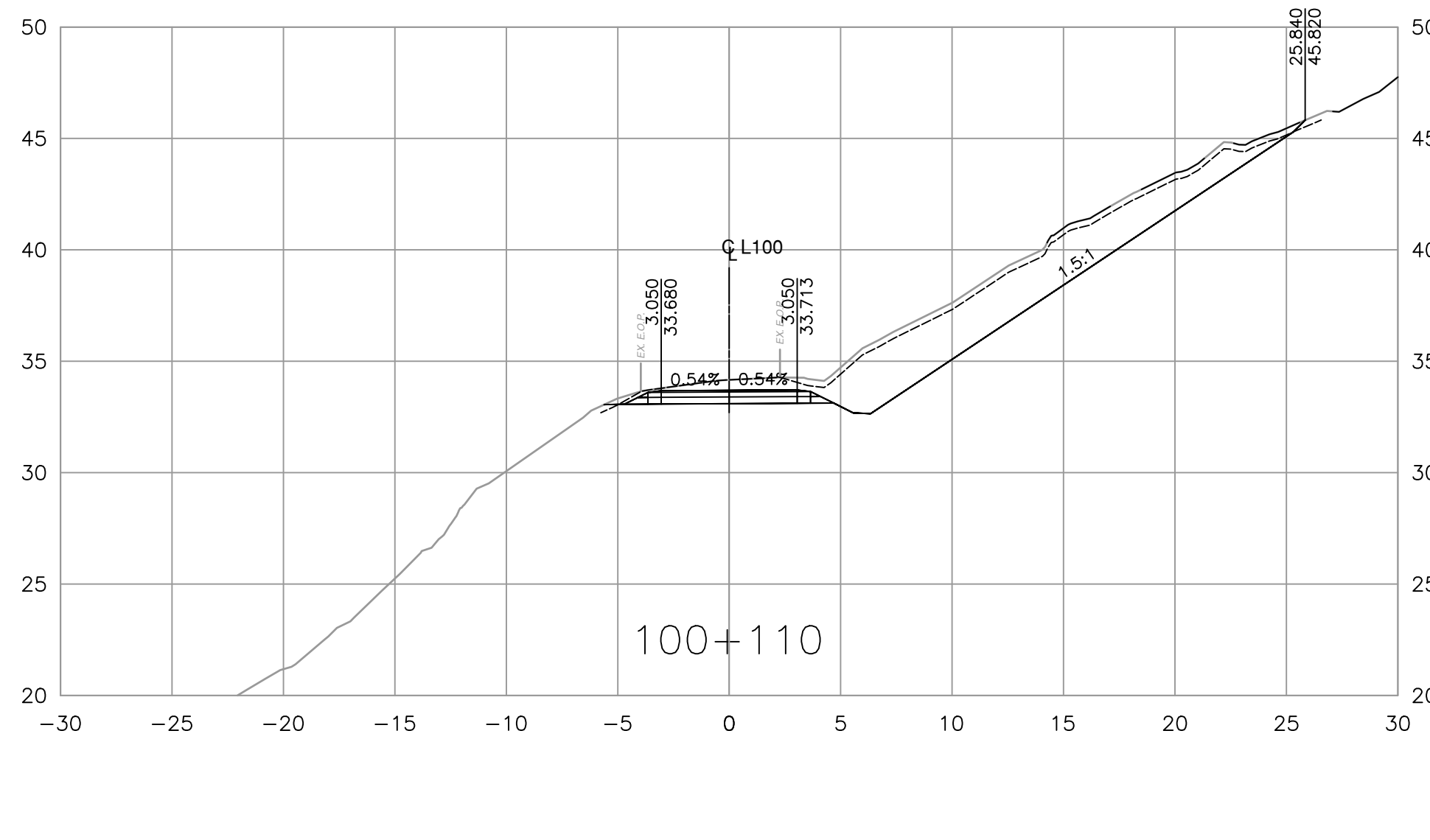
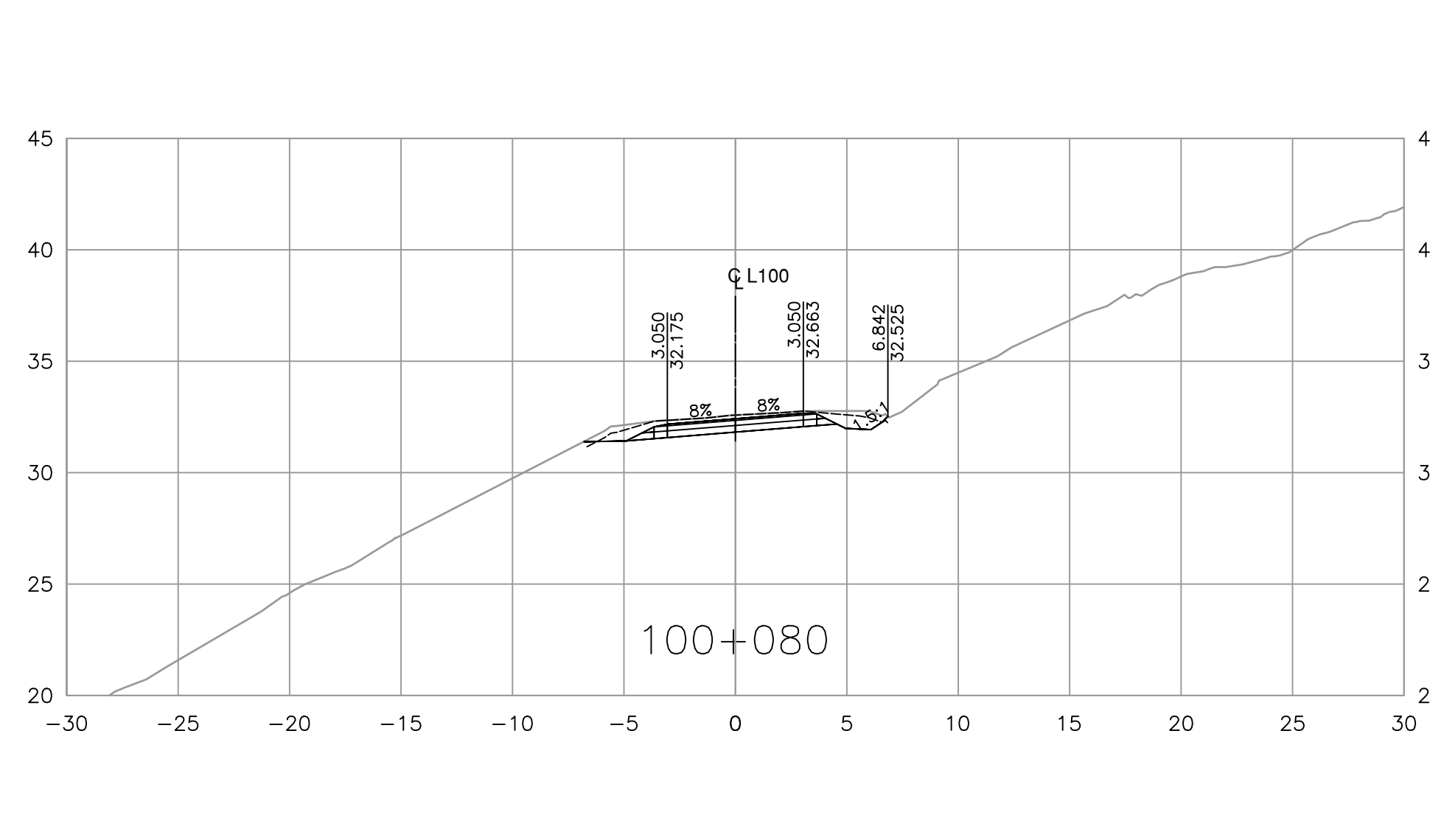
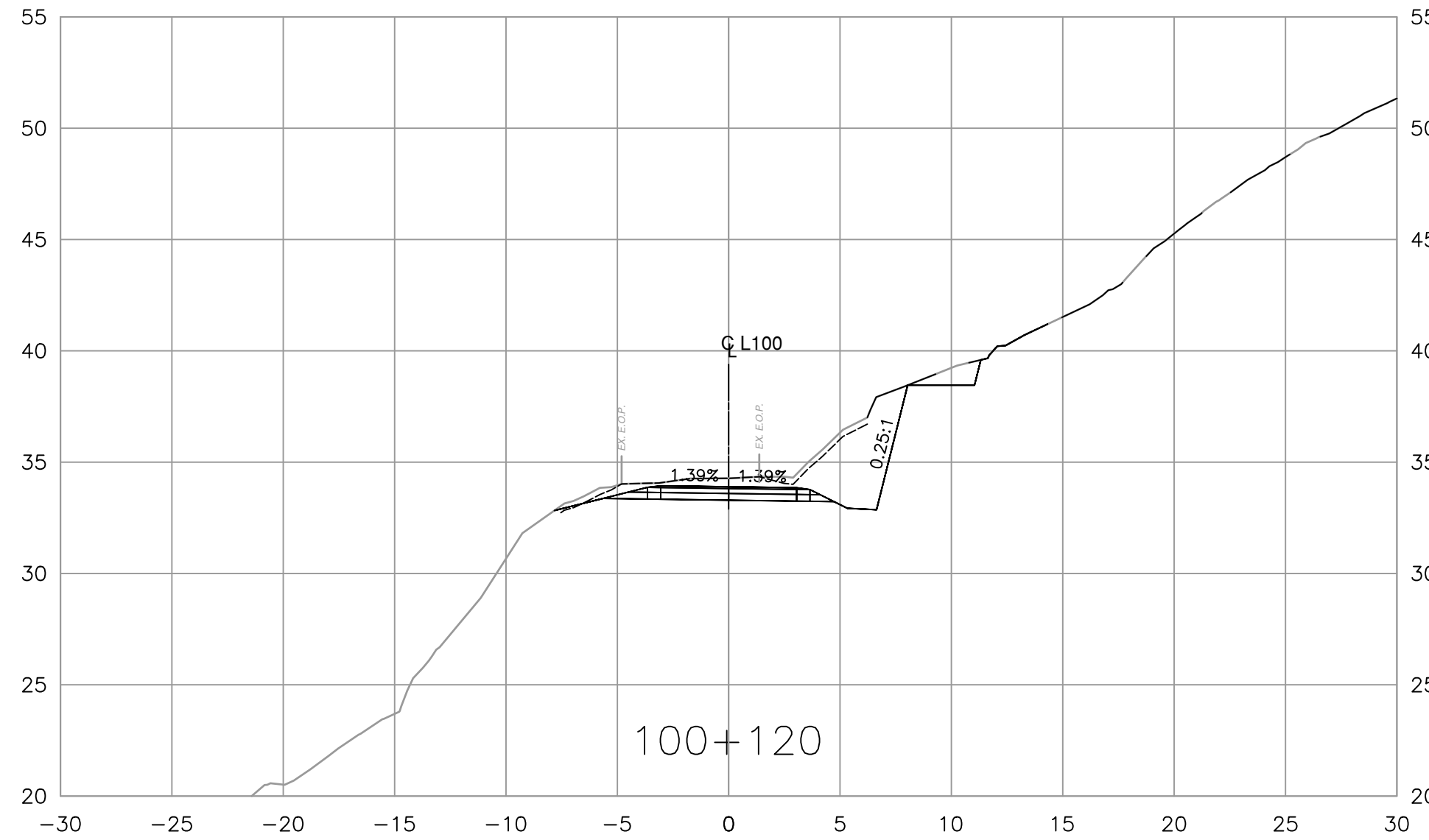
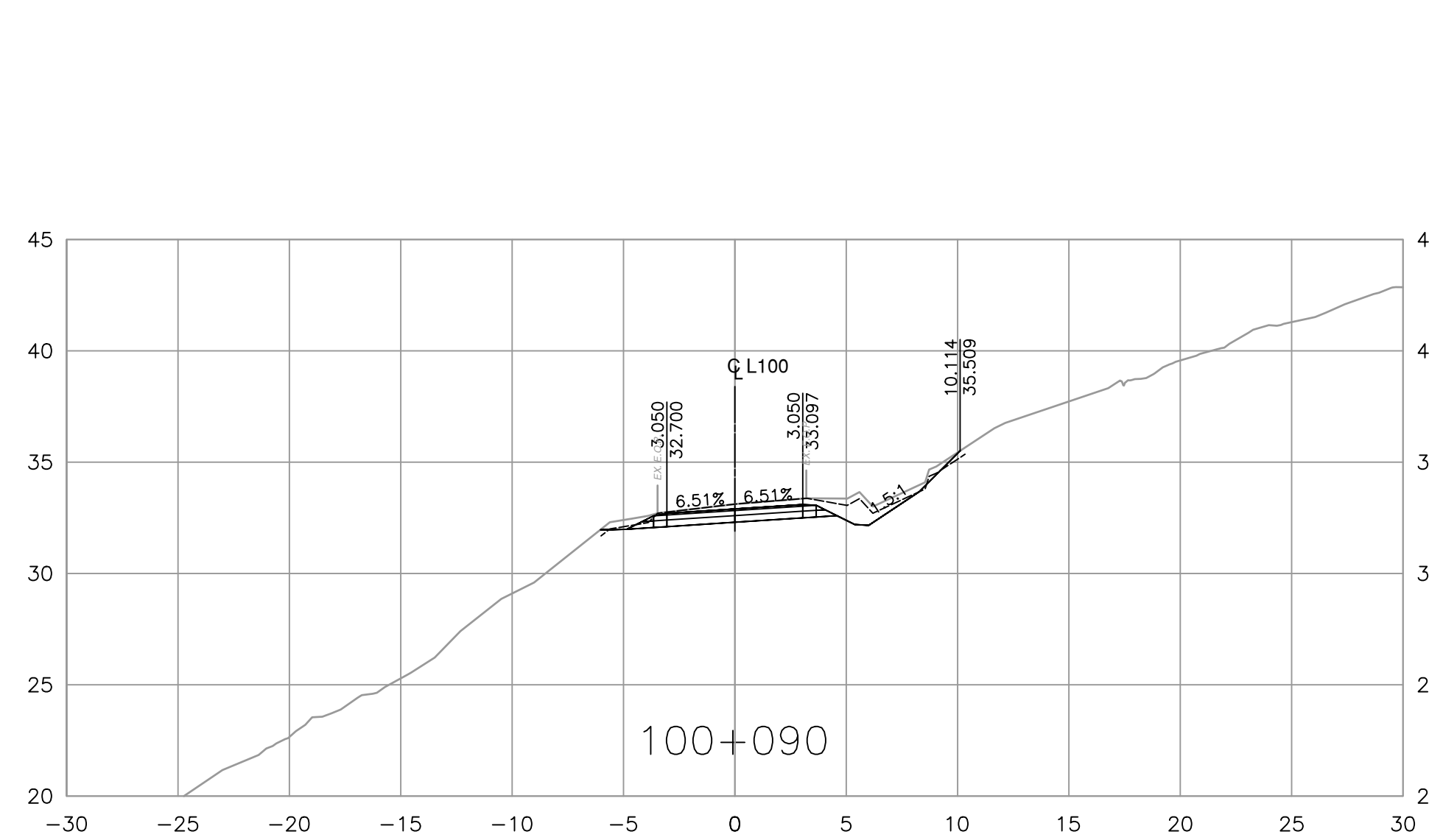

Suite 200
858 Beatty Street
Vancouver BC
Canada V6B 1C1
Tel 604 683 8521

SCALE 0 2 1:250 12m

CAD FILENAME: R1-1025-1000
PLOT DATE: 9/28/2023

REV	DATE	REVISIONS	NAME



BRITISH COLUMBIA
MINISTRY OF TRANSPORTATION AND INFRASTRUCTURE
SOUTH COAST REGION
HIGHWAY ENGINEERING AND GEOMATICS

J. PINTO
SENIOR DESIGNER
DATE: 2023-09-29

DESIGNED: A. PAN DATE: 2023-09-29
 QUALITY CONTROL: G. STEWART DATE: 2023-09-29
 QUALITY ASSURANCE: J. PINTO DATE: 2023-09-29
 DRAWN: G. HAROON DATE: 2023-09-29

CROSS SECTIONS			
CANAL ROAD DIP SLIDE SOUTH PENDER ISLAND			
STA. 100+068.757 TO STA. 100+140.000			
FILE NUMBER	PROJECT NUMBER	REG	DRAWING NUMBER
2121-00865-09	18102-0000	1	R1-1025-1001

PRINTED: September 28, 2023 - 4:12 PM
 CAD FILE: X:\1212\18102-000\1011 - Canal Road Remediation\10.0 Drawings\10.3 Engineering\CanalRoad\DrawingProduction\1003_Design\Sections\R1-1025-1002.dwg (LAST SAVED: Ghazwan)

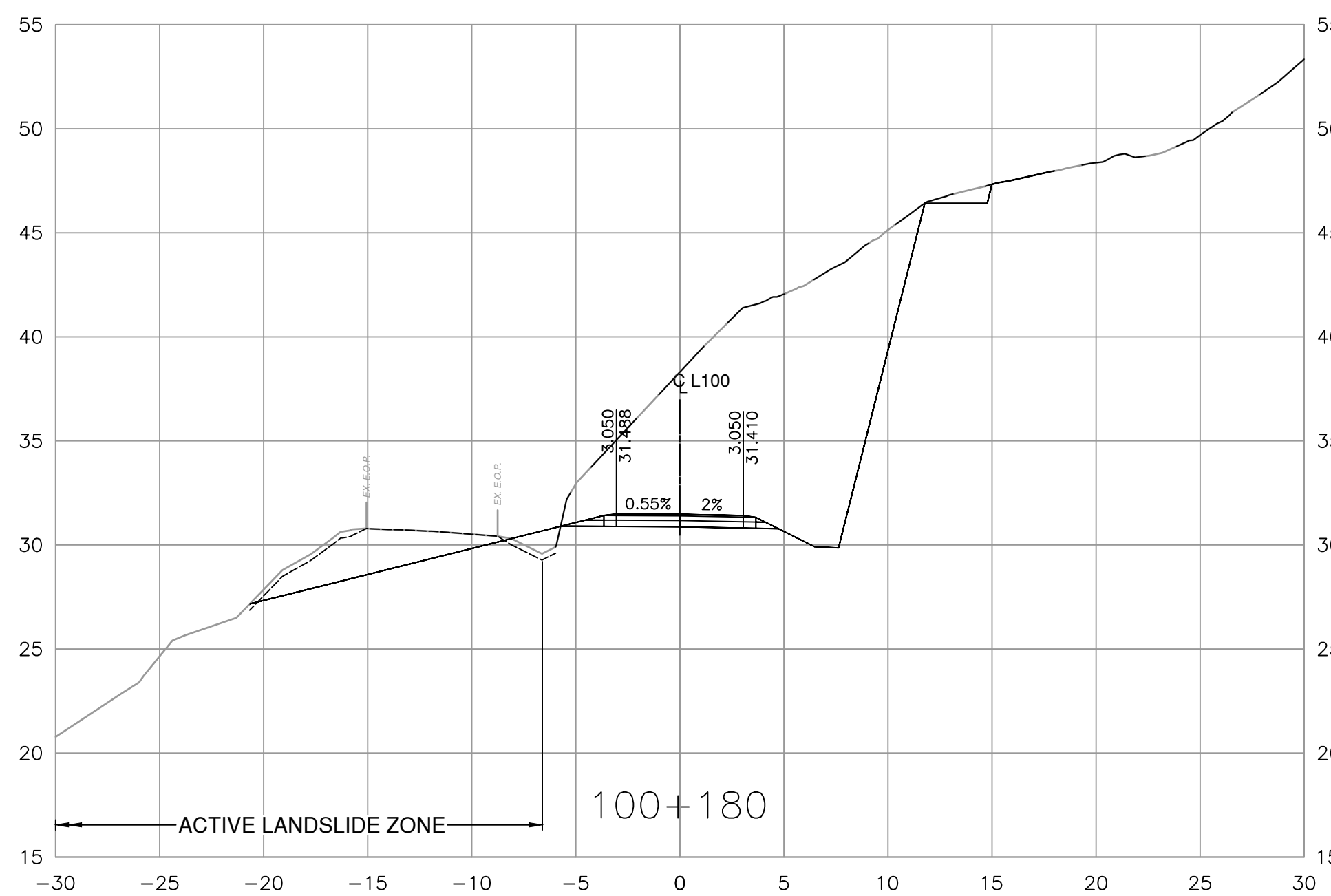
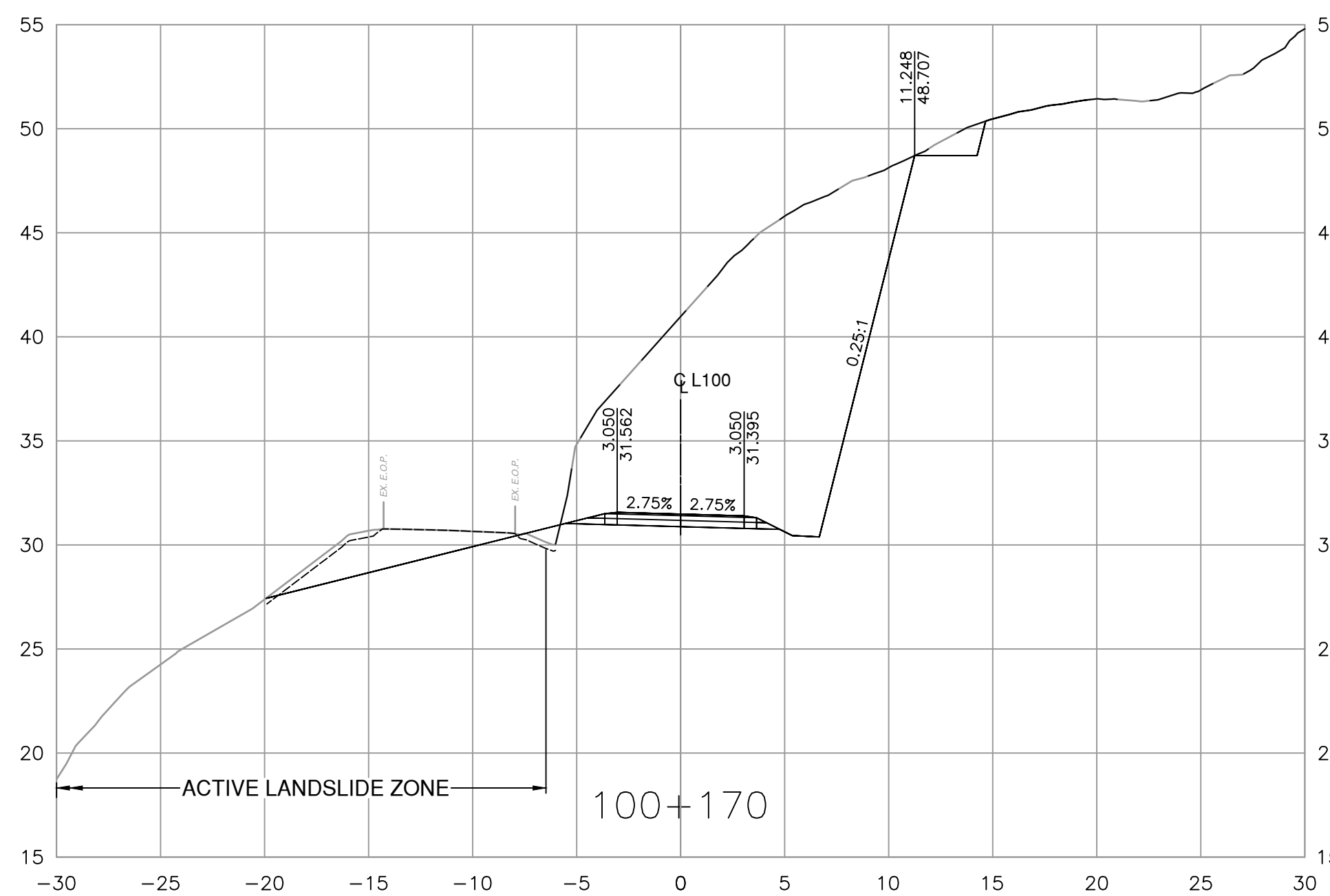
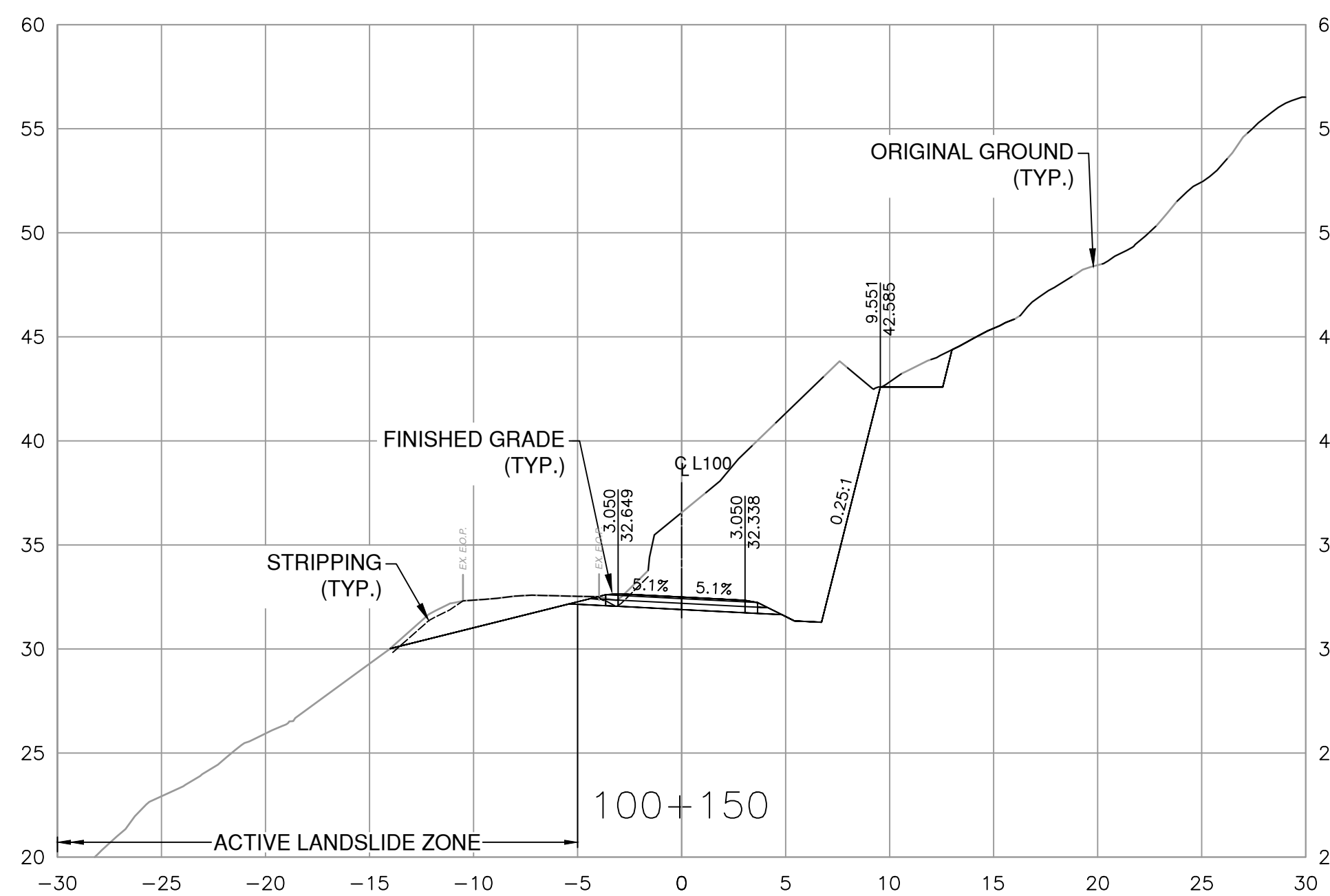
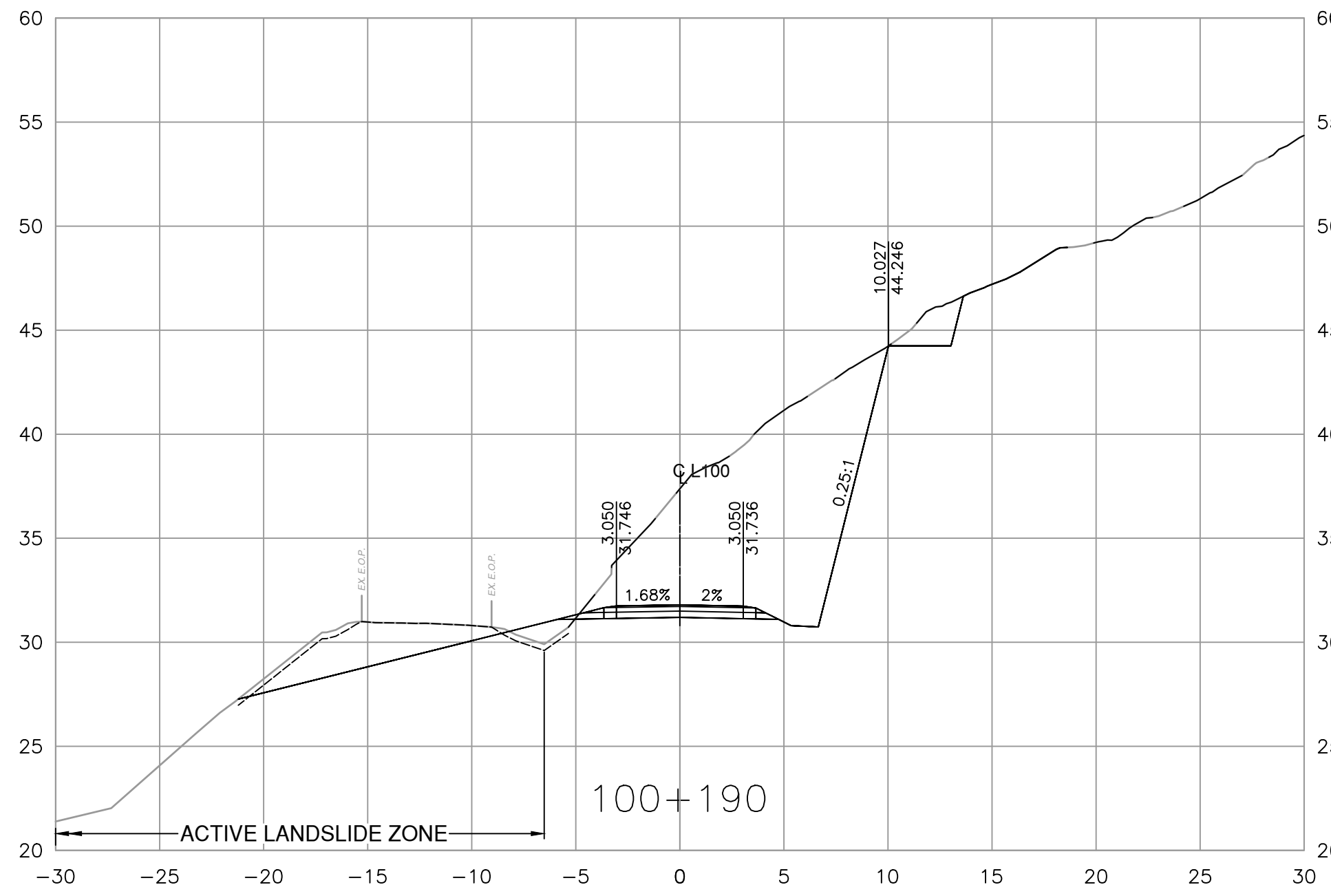
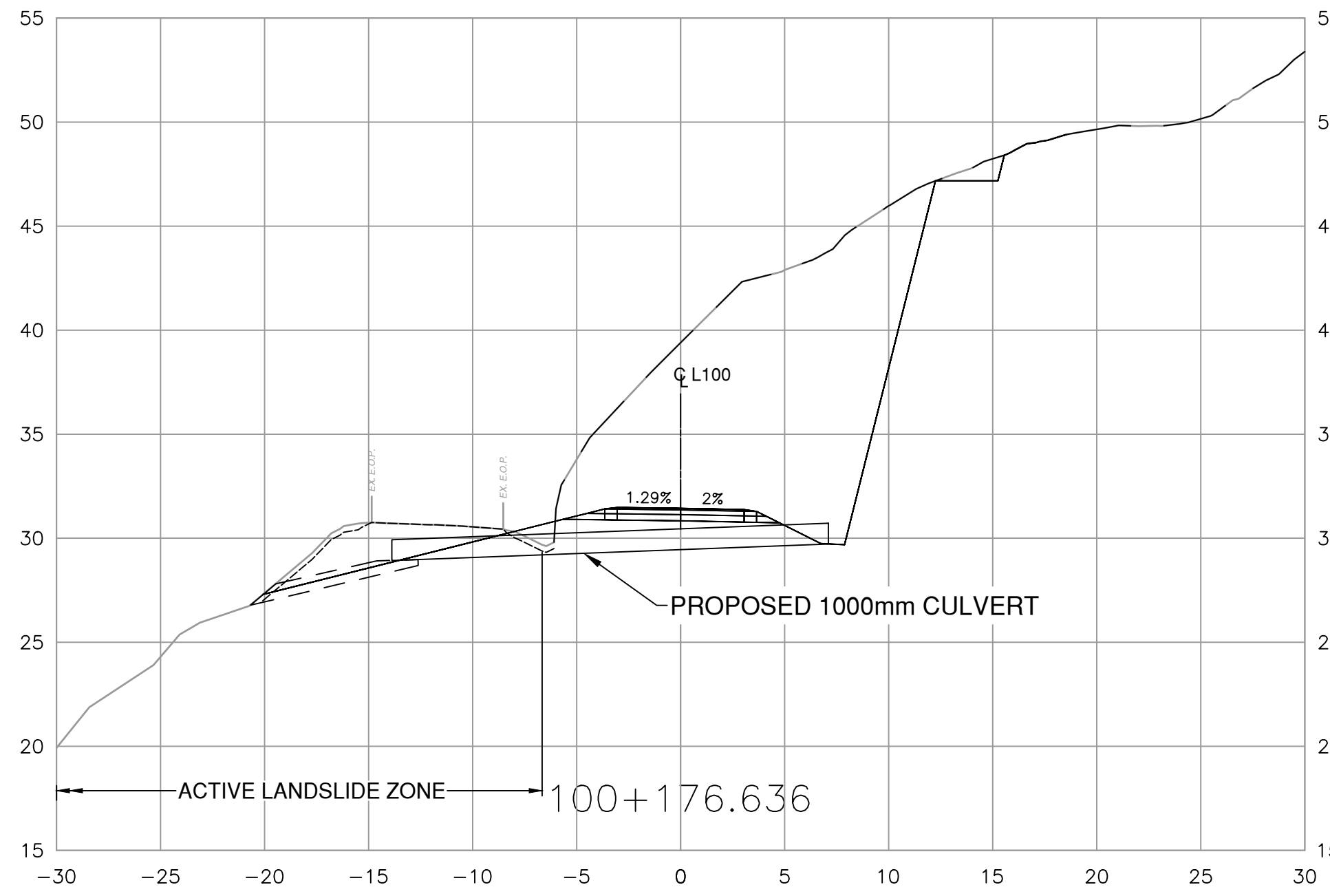
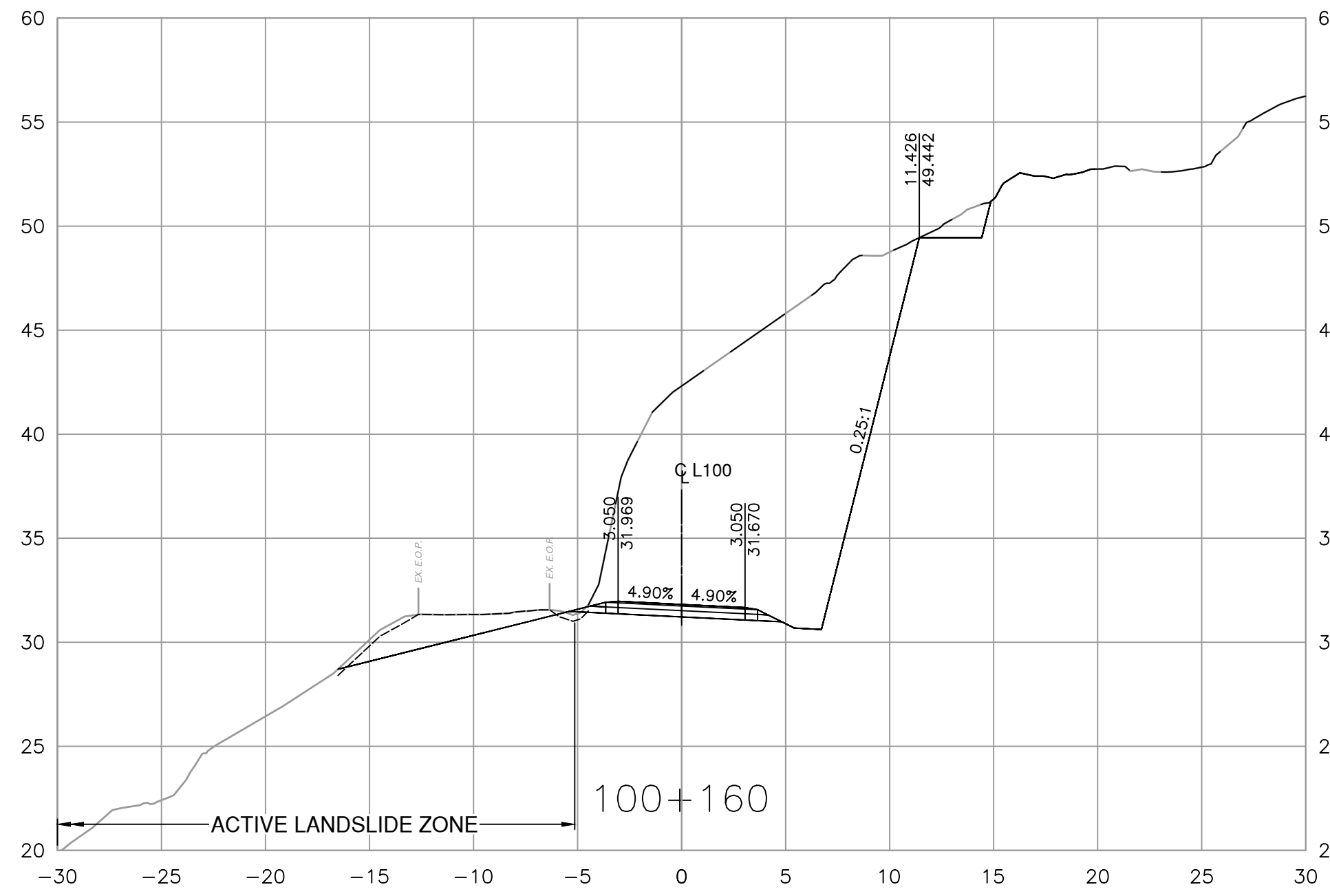

FOR REFERENCE ONLY



Suite 200
 858 Beatty Street
 Vancouver BC
 Canada V6B 1C1
 Tel 604 683 8521

SCALE 0 2 1:250 12m

CAD FILENAME: R1-1025-1000
 PLOT DATE: 9/28/2023

REV	DATE	REVISIONS	NAME



MINISTRY OF TRANSPORTATION AND INFRASTRUCTURE
 SOUTH COAST REGION
 HIGHWAY ENGINEERING AND GEOMATICS

J. PINTO
 SENIOR DESIGNER
 DATE: 2023-09-29

DESIGNED: A. PAN DATE: 2023-09-29
 QUALITY CONTROL: G. STEWART DATE: 2023-09-29
 QUALITY ASSURANCE: J. PINTO DATE: 2023-09-29
 DRAWN: G. HAROON DATE: 2023-09-29



CROSS SECTIONS
 CANAL ROAD DIP SLIDE
 SOUTH PENDER ISLAND

STA. 100+150.000 TO STA. 100+190.000

FILE NUMBER	PROJECT NUMBER	REG	DRAWING NUMBER	REV
2121-00865-09	18102-0000	1	R1-1025-1002	-

PRINTED: September 28, 2023 - 4:12 PM
 CAD FILE: X:\1212\18102-000\101 - Canal Road Remediation\10.0 Drawings\10.3 Engineering\Canal Road\Drawings\Production\1003_Design\Sections\R1-1025-1003.dwg (LAST SAVED: Gharoon)

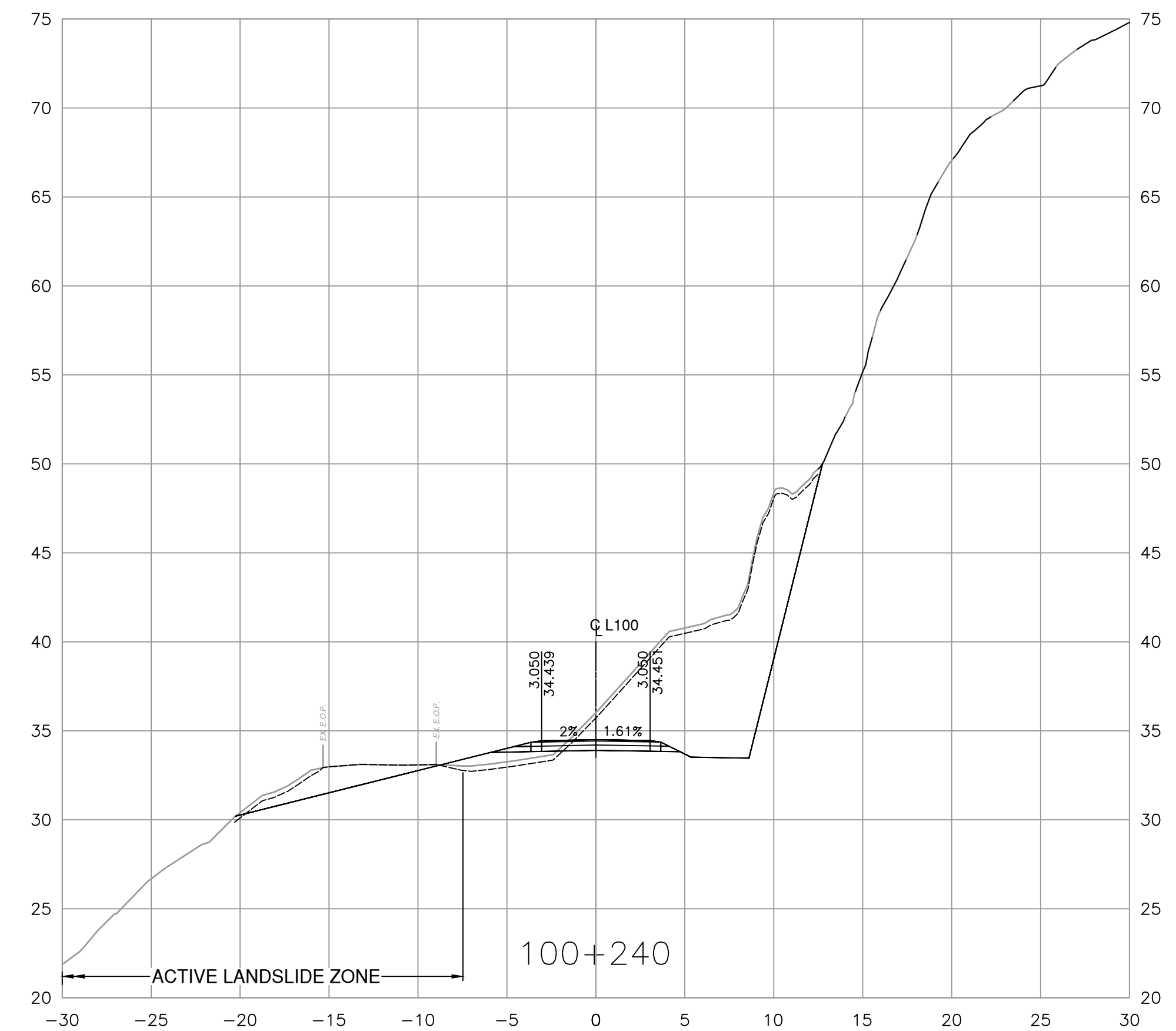
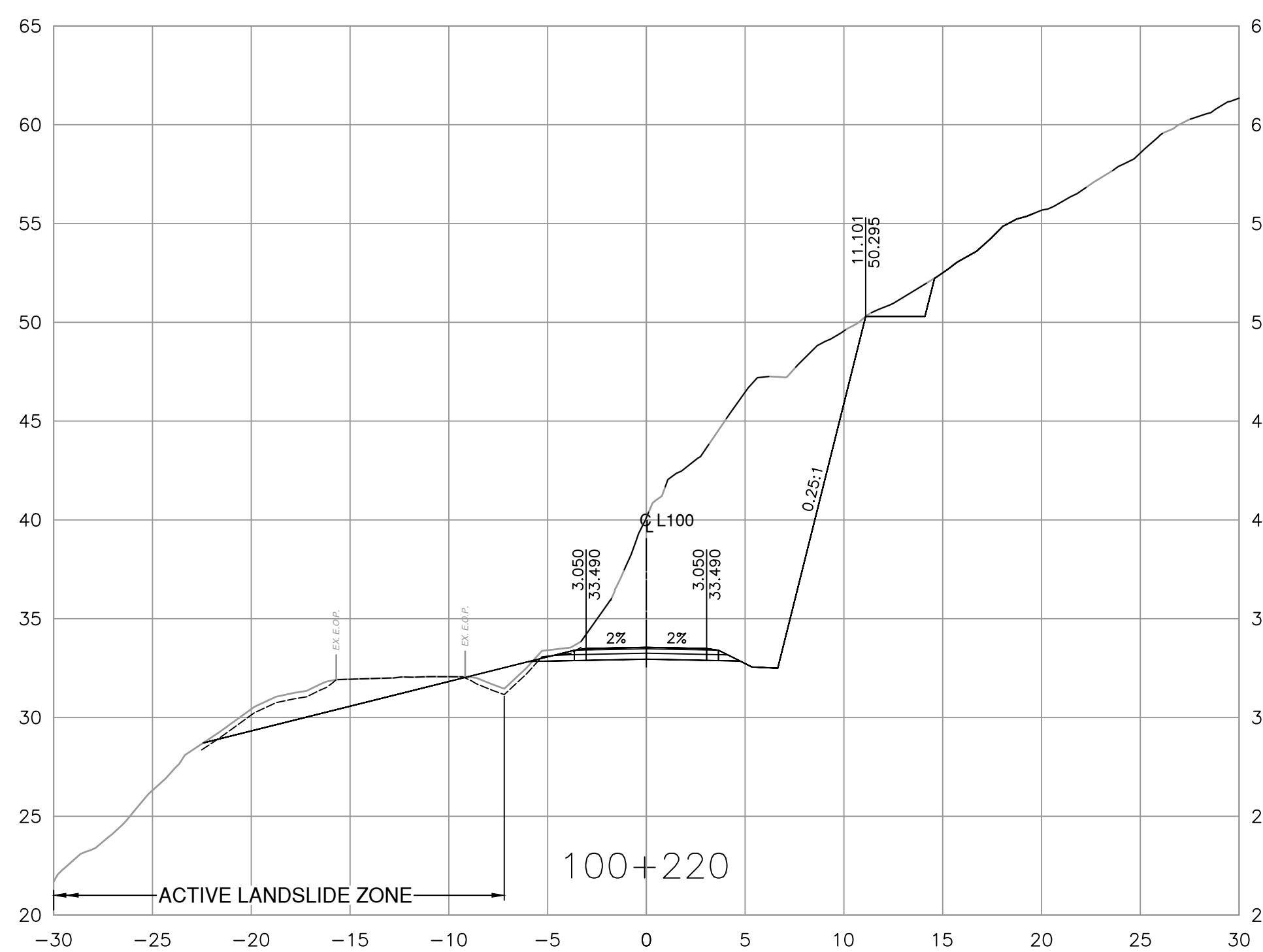
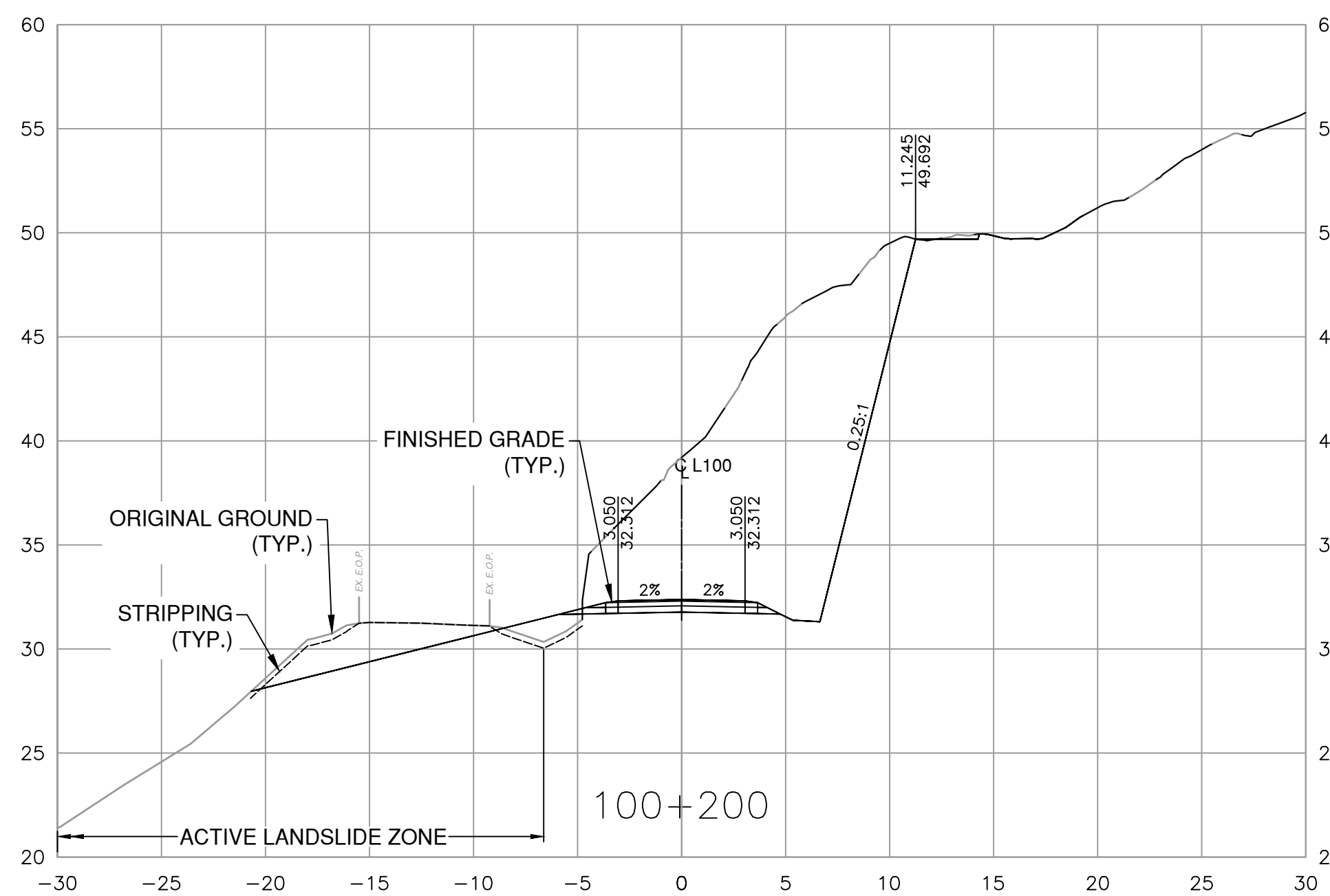
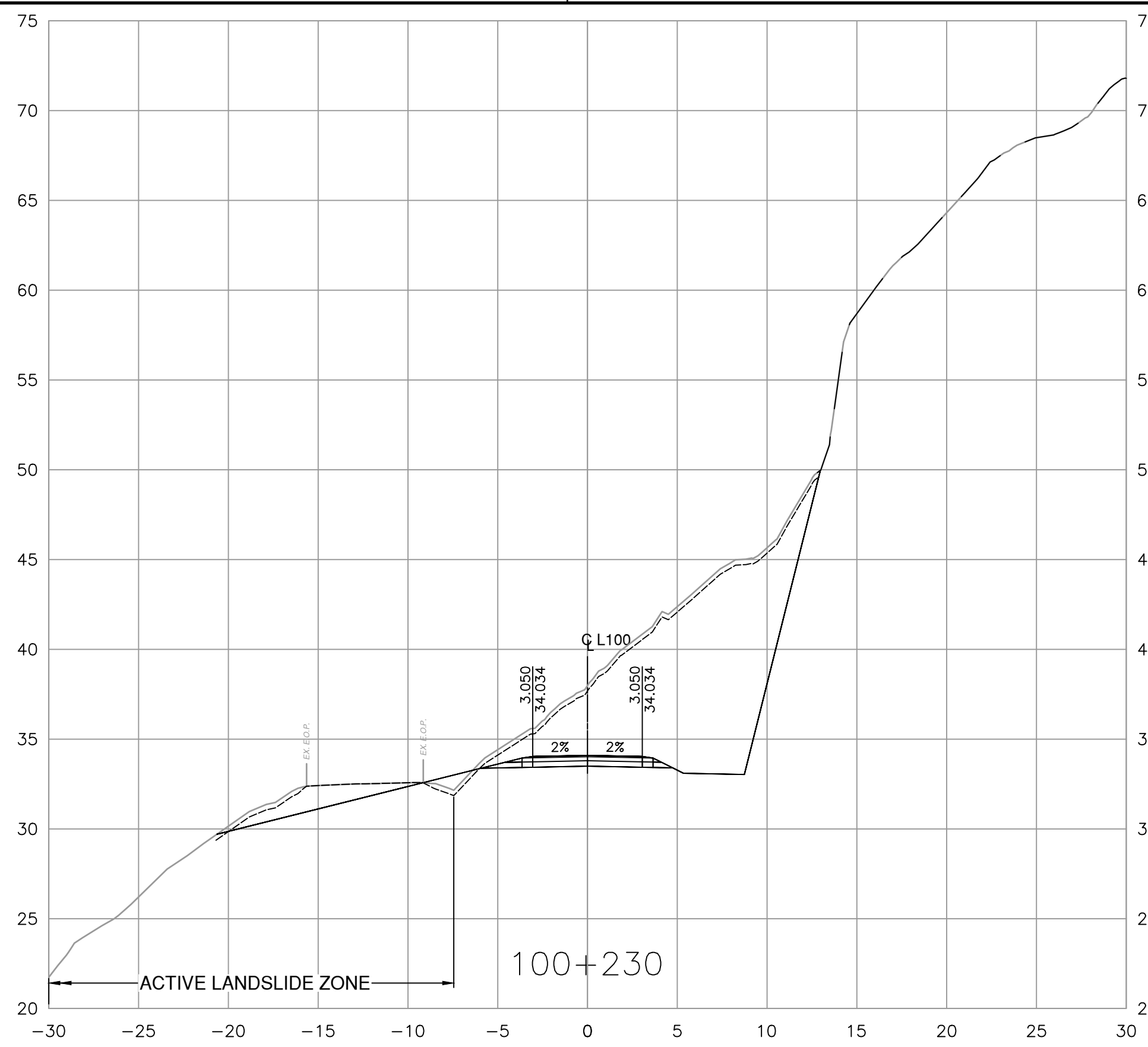
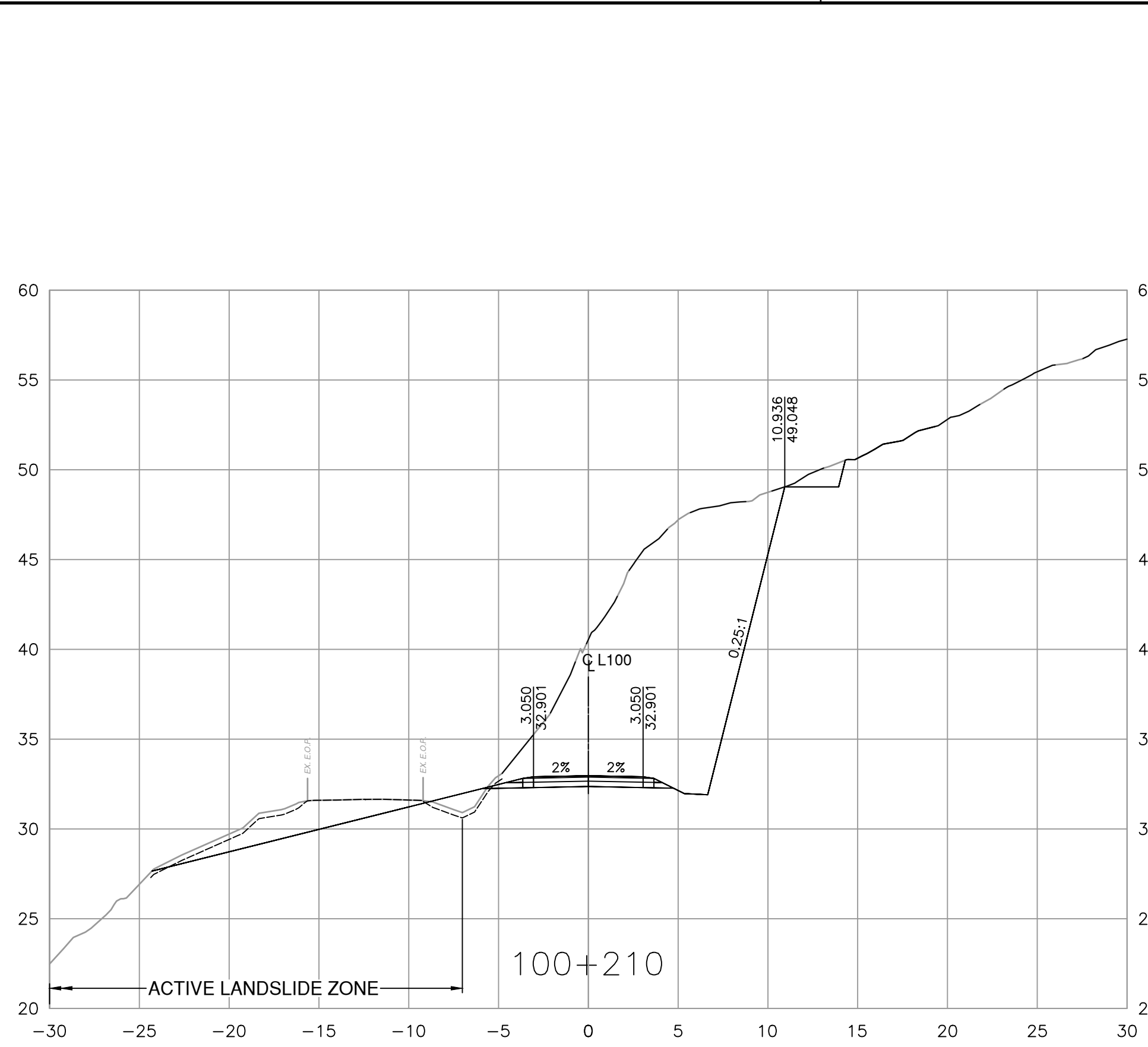

FOR REFERENCE ONLY



Suite 200
 858 Beatty Street
 Vancouver BC
 Canada V6B 1C1
 Tel 604 683 8521

CAD FILENAME: R1-1025-1000
 PLOT DATE: 9/28/2023

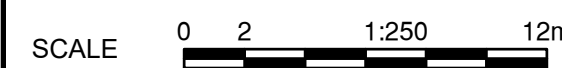

REV	DATE	REVISIONS	NAME



MINISTRY OF TRANSPORTATION AND INFRASTRUCTURE
 SOUTH COAST REGION
 HIGHWAY ENGINEERING AND GEOMATICS

J. PINTO
 SENIOR DESIGNER
 DATE: 2023-09-29

DESIGNED: A. PAN DATE: 2023-09-29
 QUALITY CONTROL: G. STEWART DATE: 2023-09-29
 QUALITY ASSURANCE: J. PINTO DATE: 2023-09-29
 DRAWN: G. HAROON DATE: 2023-09-29



CROSS SECTIONS
 CANAL ROAD DIP SLIDE
 SOUTH PENDER ISLAND

STA. 100+200.000 TO STA. 100+240.000

FILE NUMBER	PROJECT NUMBER	REG	DRAWING NUMBER	REV
2121-00865-09	18102-0000	1	R1-1025-1003	-

PRINTED: September 28, 2023 - 4:12 PM
 CAD FILE: X:\2121-00865-09\001 - Canal Road Remediatio\10.0 Drawings\10.3 Engineering\CanalRoad\DrawingProduction\1003_Design\Sections\R1-1025-1004.dwg (LAST SAVED: Chahoon)

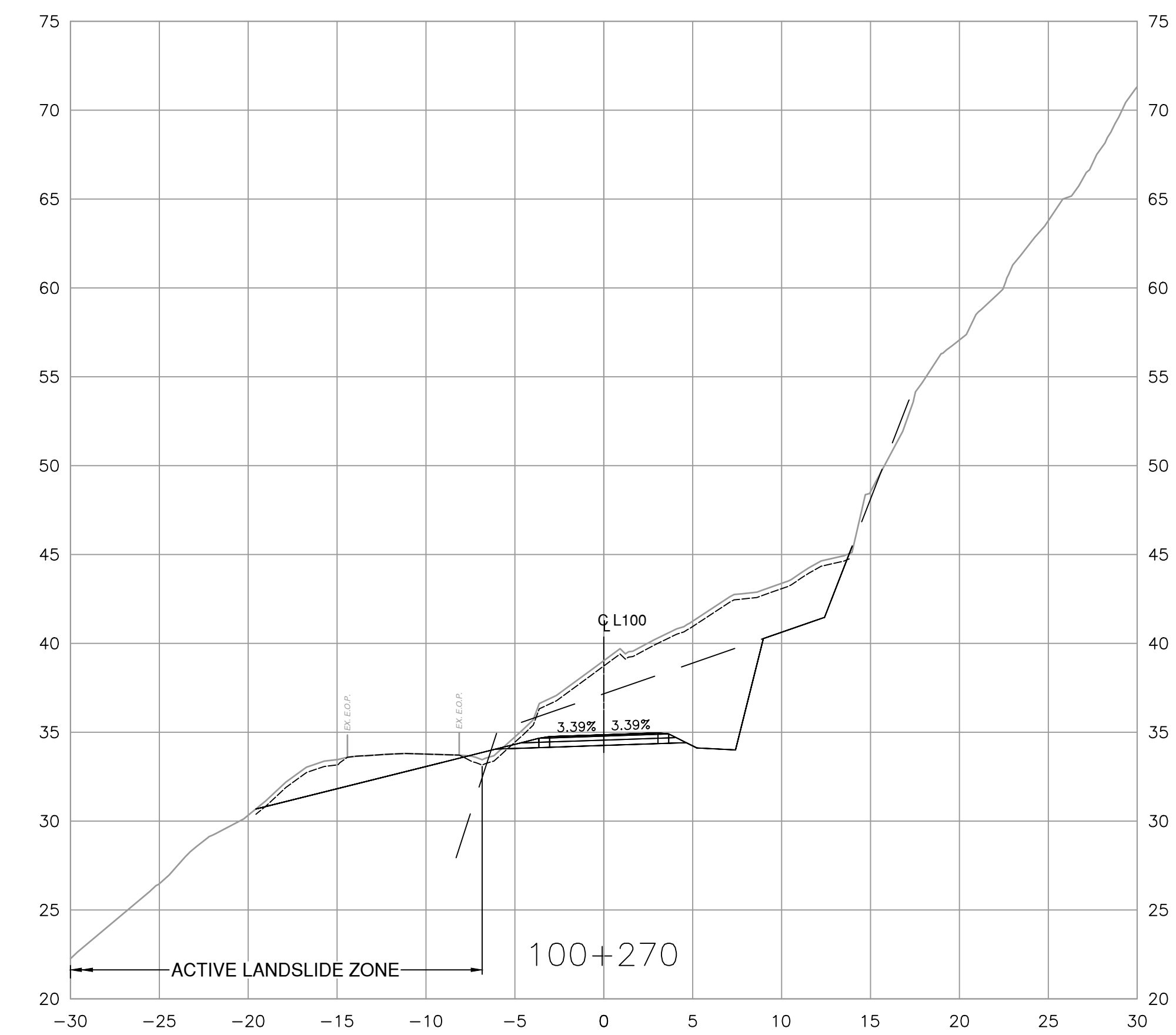
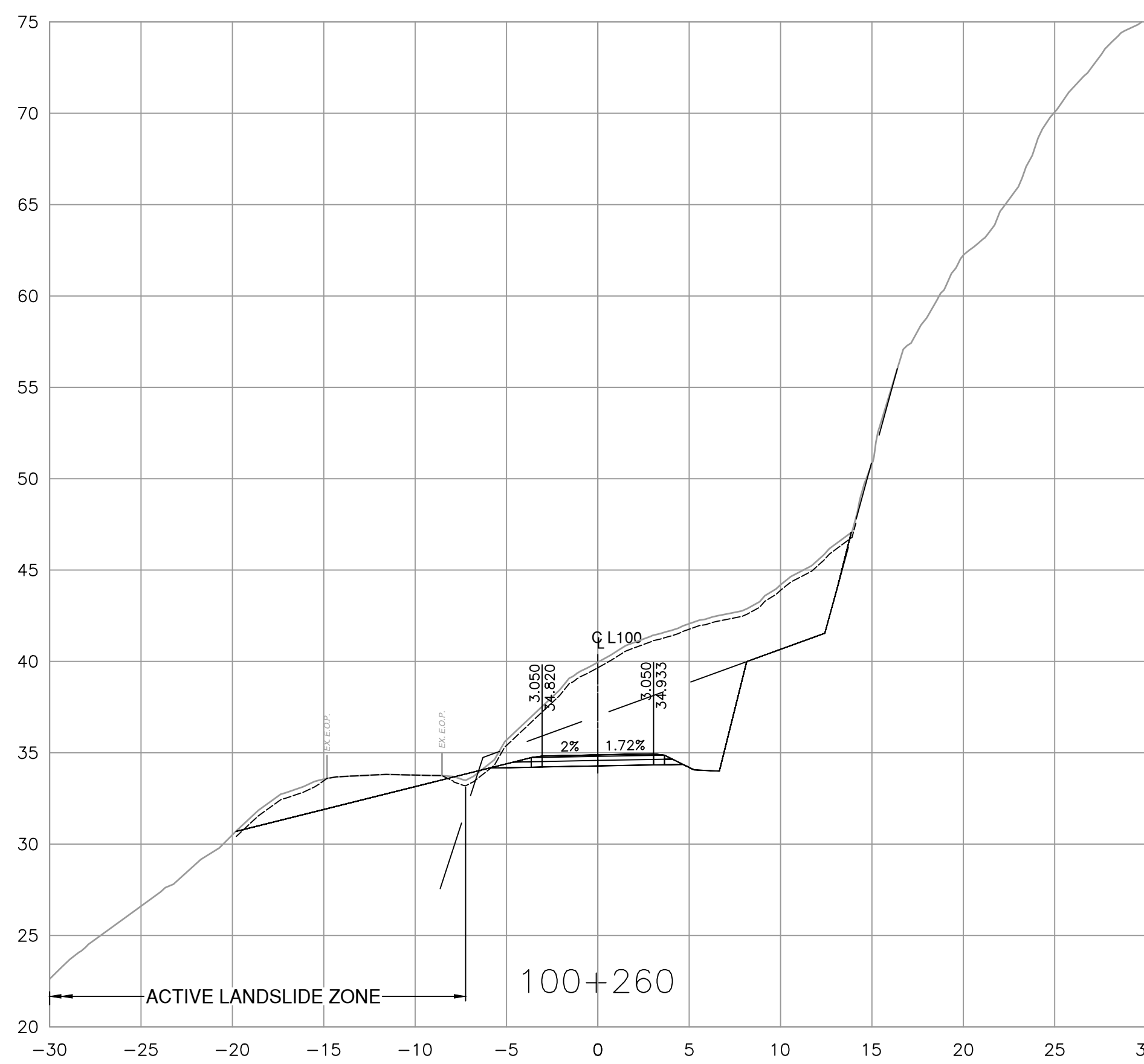
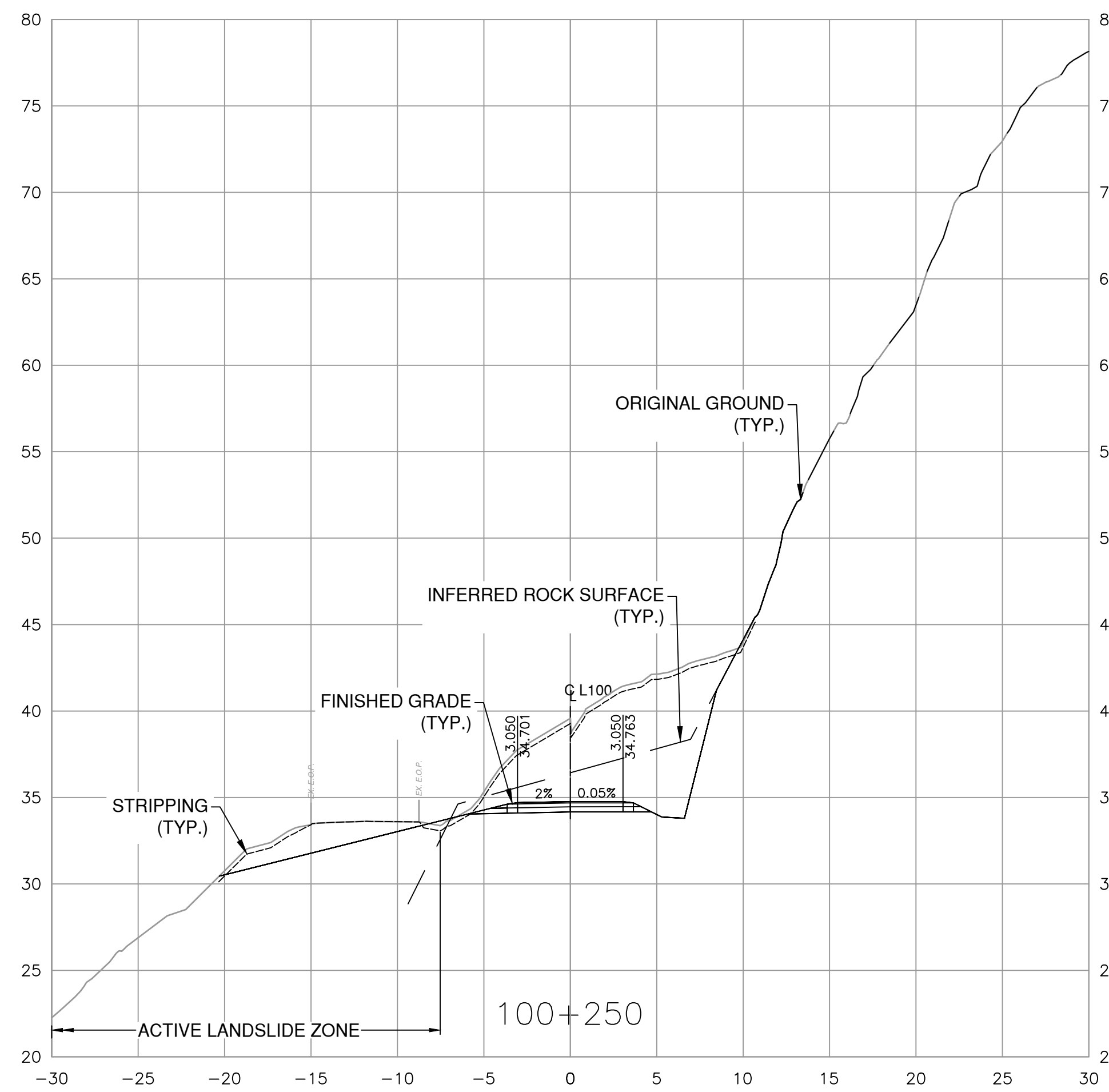

FOR REFERENCE ONLY



Suite 200
 858 Beatty Street
 Vancouver BC
 Canada V6B 1C1
 Tel 604 683 8521

CAD FILENAME: R1-1025-1000
 PLOT DATE: 9/28/2023

SCALE 0 2 1:250 12m

REV	DATE	REVISIONS	NAME



MINISTRY OF TRANSPORTATION AND INFRASTRUCTURE
 SOUTH COAST REGION
 HIGHWAY ENGINEERING AND GEOMATICS

J. PINTO
 SENIOR DESIGNER
 DATE: 2023-09-29

DESIGNED: A. PAN DATE: 2023-09-29
 QUALITY CONTROL: G. STEWART DATE: 2023-09-29
 QUALITY ASSURANCE: J. PINTO DATE: 2023-09-29
 DRAWN: G. HAROON DATE: 2023-09-29



CROSS SECTIONS
 CANAL ROAD DIP SLIDE
 SOUTH PENDER ISLAND
 STA. 100+250.000 TO STA. 100+270.000

FILE NUMBER	PROJECT NUMBER	REG	DRAWING NUMBER	REV
2121-00865-09	18102-0000	1	R1-1025-1004	-

PRINTED: September 28, 2023 - 4:12 PM
 CAD FILE: X:\1212\18102-000\18101 - Canal Road Remediatio\10.0 Drawings\10.3 Engineering\CanalRoad\DrawingProduction\1003_Design\Sections\R1-1025-1005.dwg (LAST SAVED: Chharon)

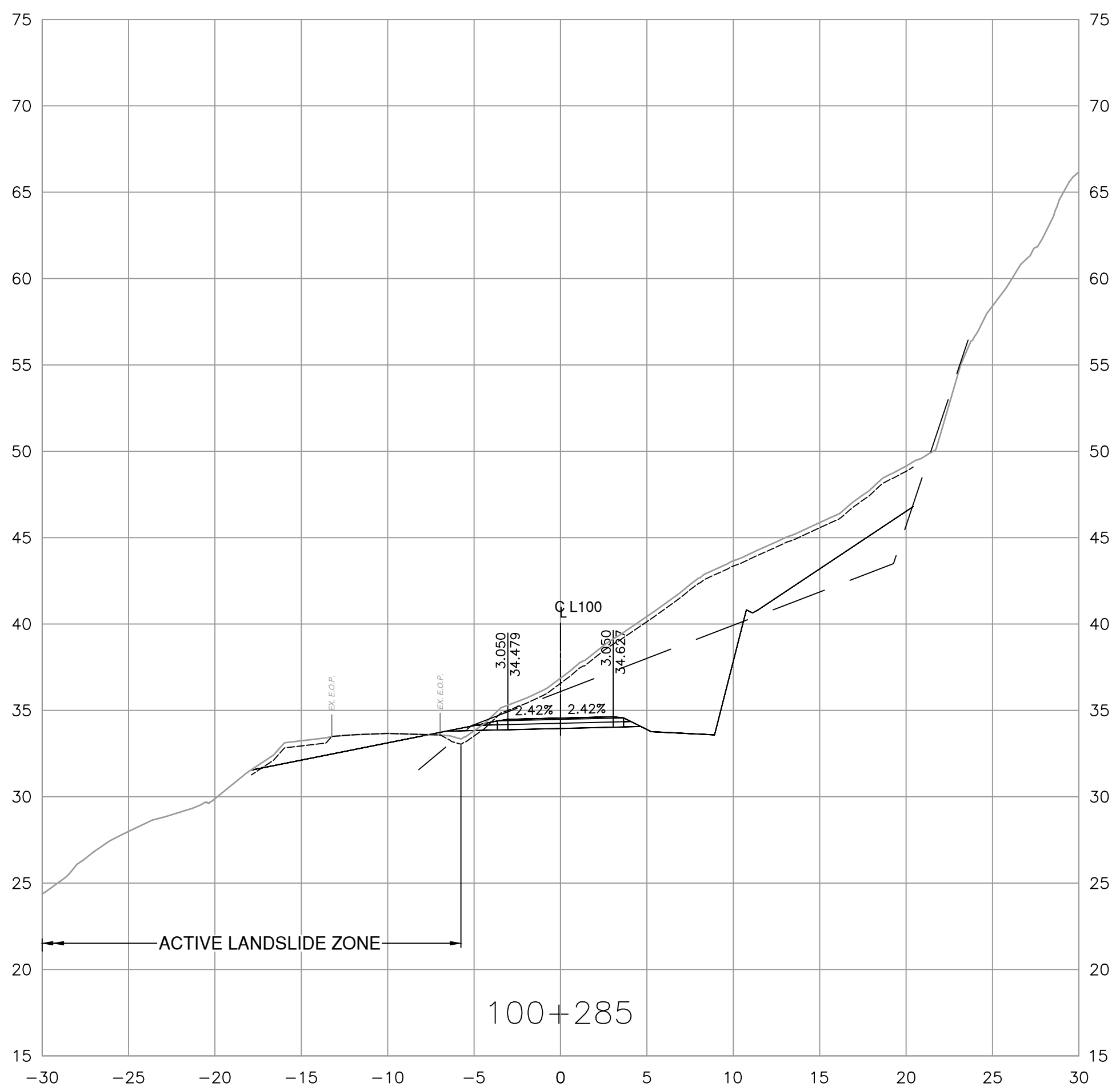
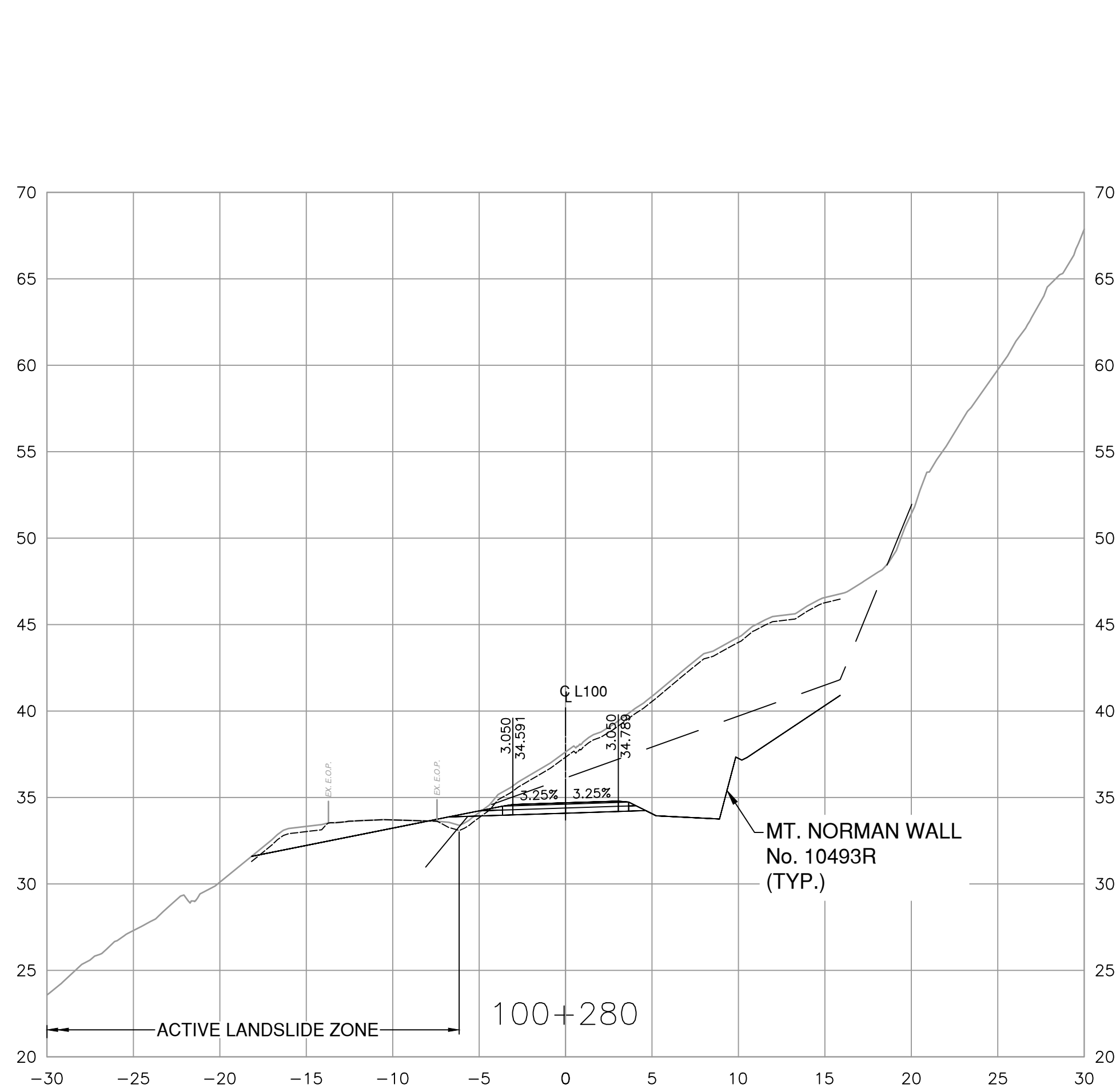
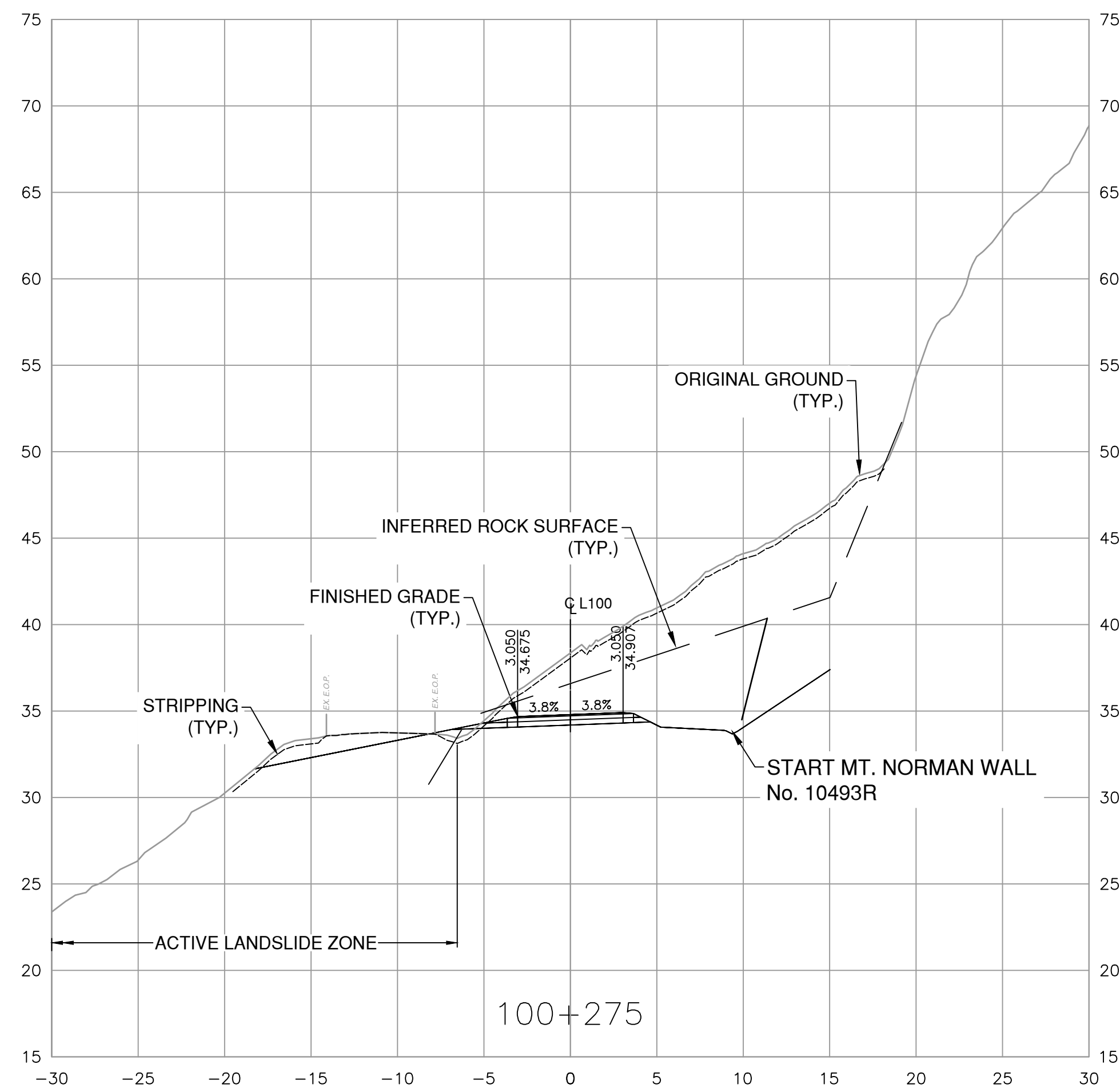

FOR REFERENCE ONLY



Suite 200
 858 Beatty Street
 Vancouver BC
 Canada V6B 1C1
 Tel 604 683 8521

CAD FILENAME: R1-1025-1000
 PLOT DATE: 9/28/2023



REV	DATE	REVISIONS	NAME



BRITISH COLUMBIA
 MINISTRY OF TRANSPORTATION AND INFRASTRUCTURE
 SOUTH COAST REGION
 HIGHWAY ENGINEERING AND GEOMATICS

J. PINTO
 SENIOR DESIGNER
 DATE: 2023-09-29

DESIGNED: A. PAN DATE: 2023-09-29
 QUALITY CONTROL: G. STEWART DATE: 2023-09-29
 QUALITY ASSURANCE: J. PINTO DATE: 2023-09-29
 DRAWN: G. HAROON DATE: 2023-09-29



CROSS SECTIONS
 CANAL ROAD DIP SLIDE
 SOUTH PENDER ISLAND
 STA. 100+275.000 TO STA. 100+285.000

FILE NUMBER	PROJECT NUMBER	REG	DRAWING NUMBER	REV
2121-00865-09	18102-0000	1	R1-1025-1005	-

PRINTED: September 28, 2023 - 4:12 PM
 CAD FILE: X:\1212\18102-000\18101 - Canal Road Remediation\10.0 DRAWINGS\10.3 Engineering\CanalRoad\DrawingProduction\1003_Design\SectionR1-1025-1006.dwg (LAST SAVED: Gharoon)

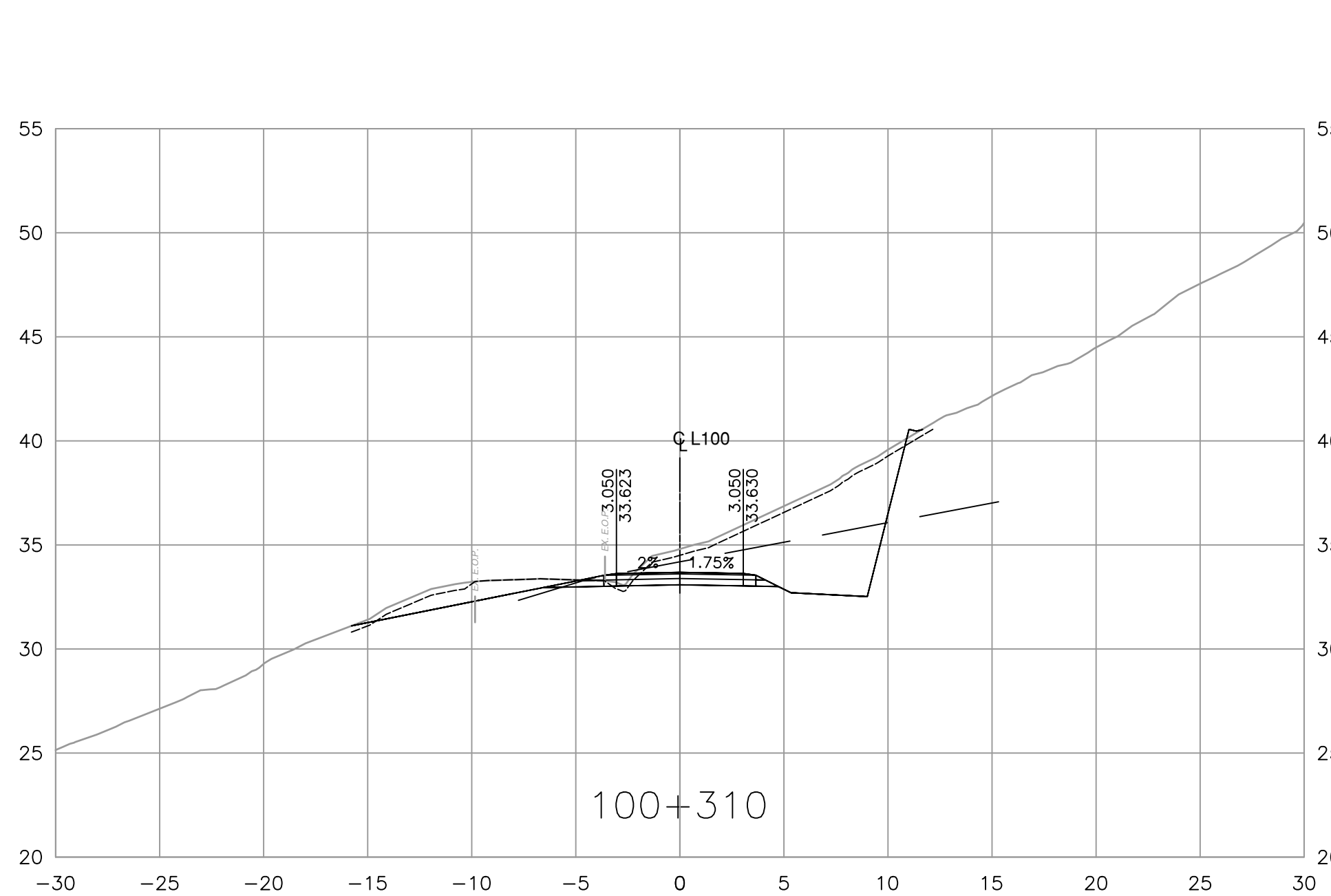
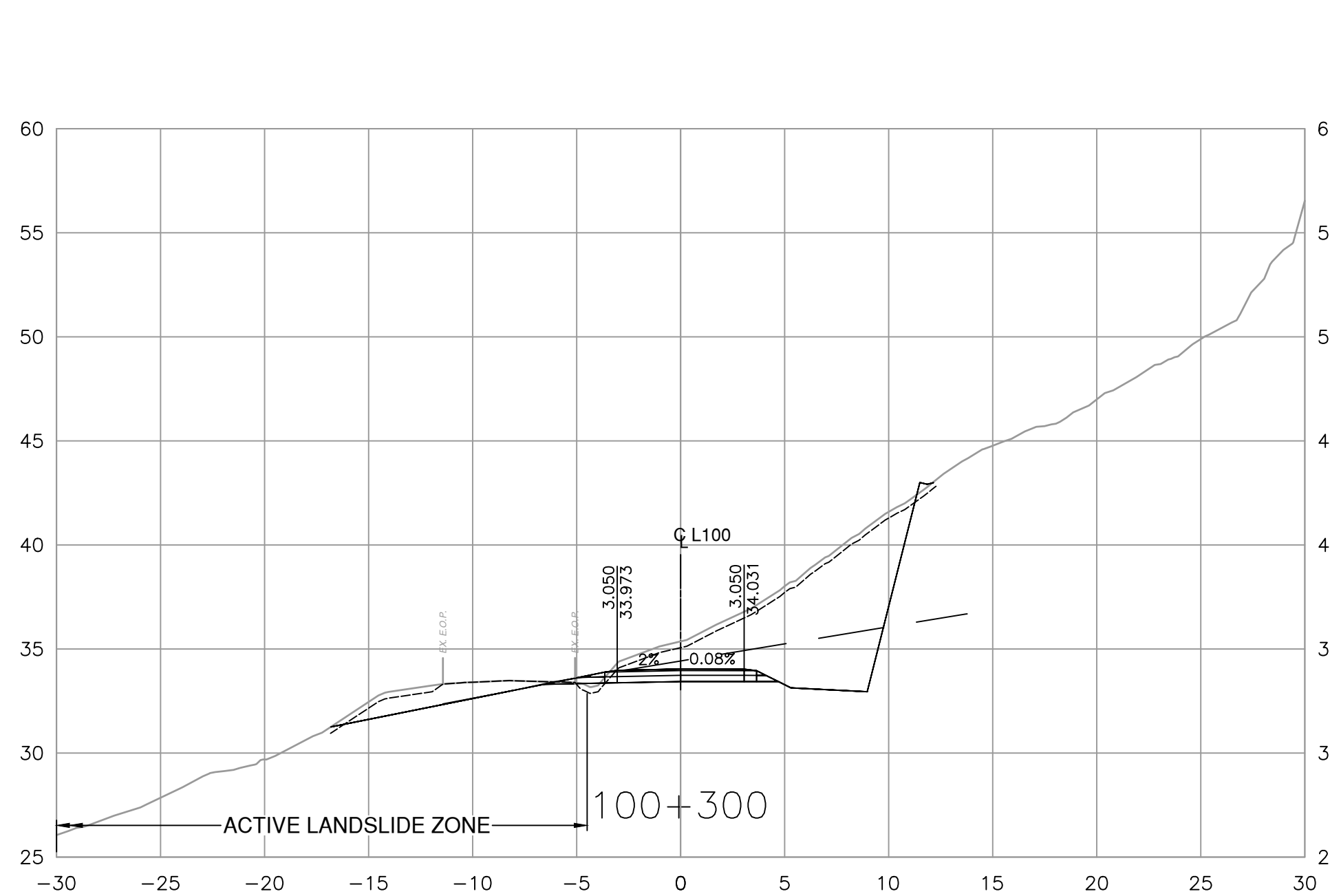
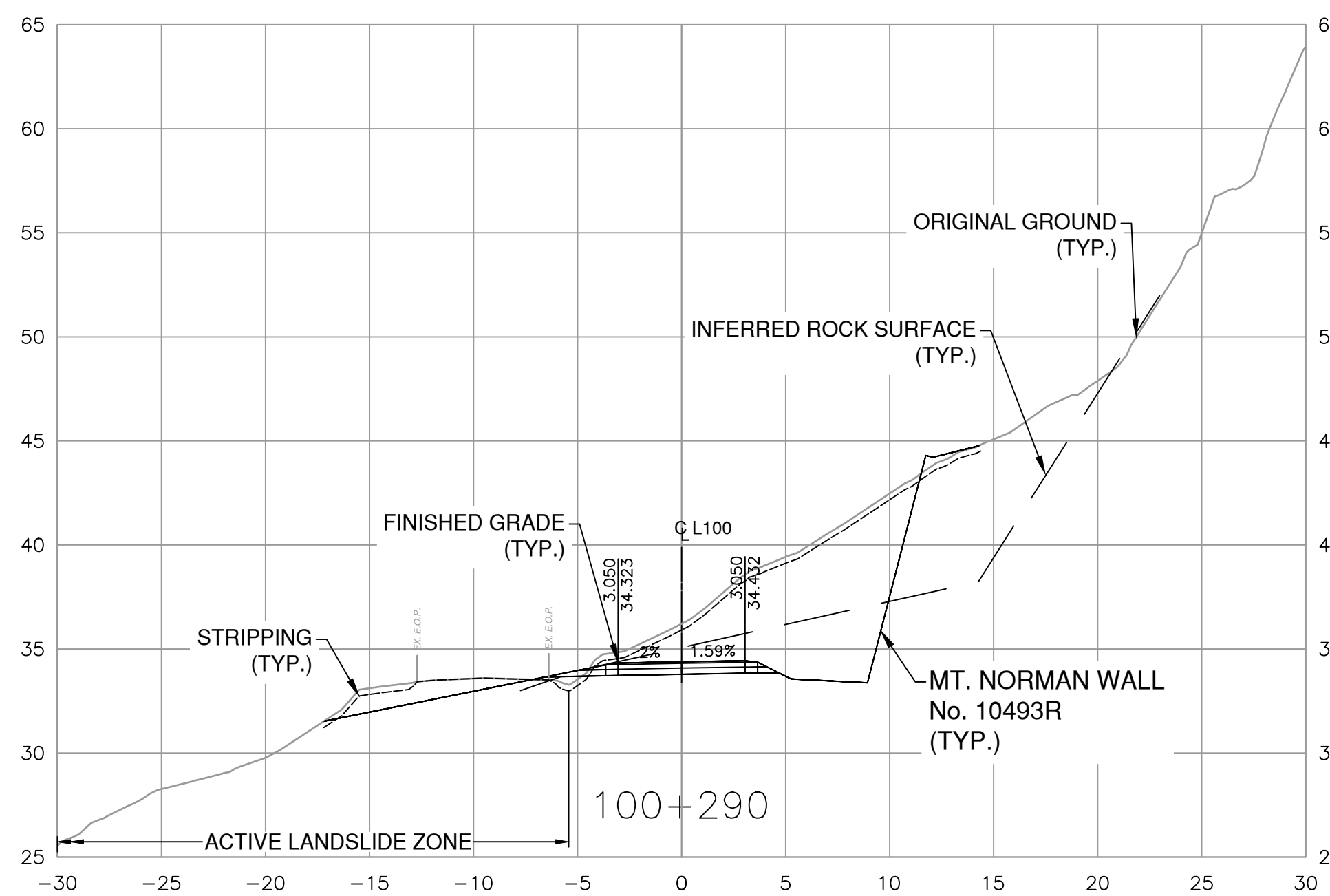
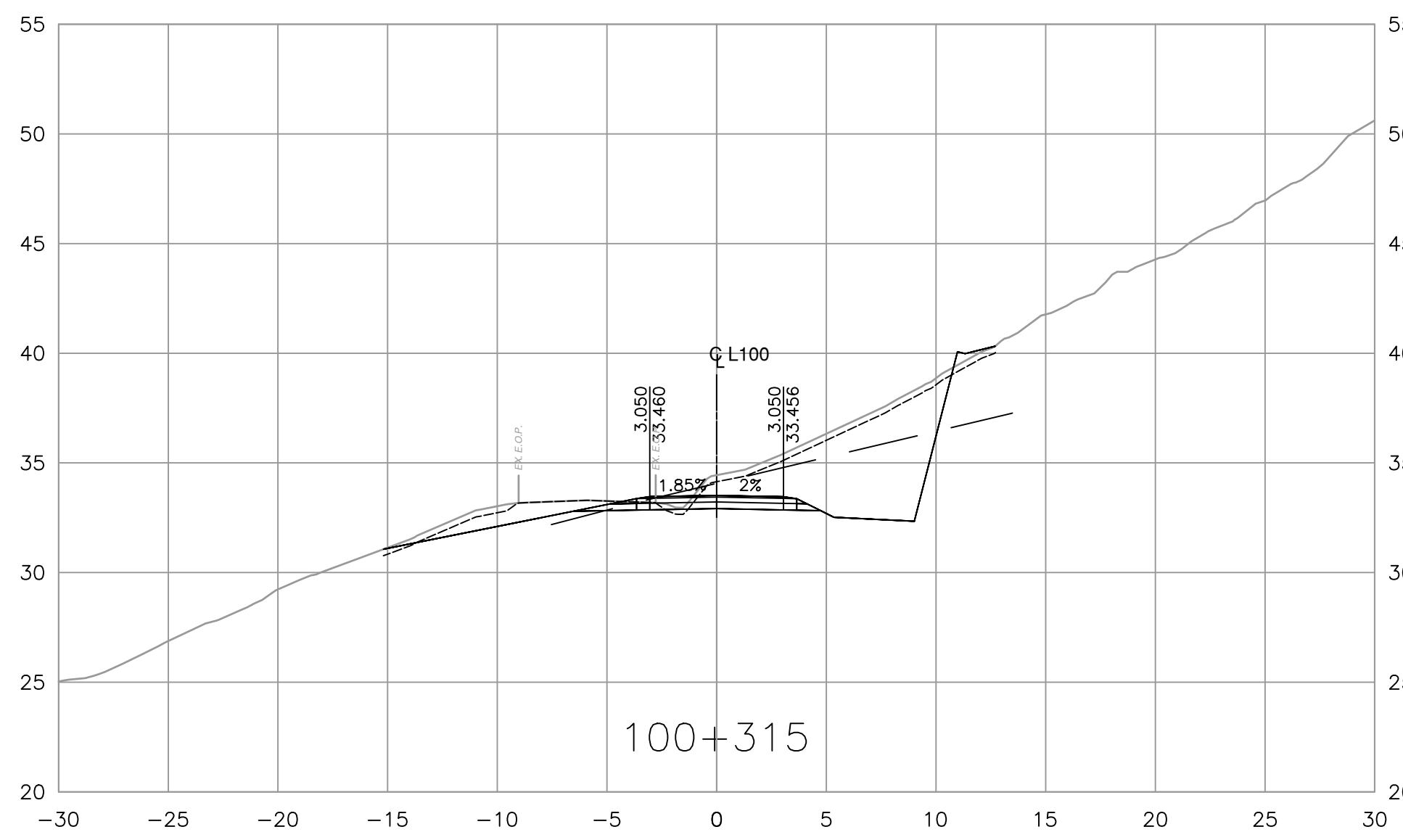
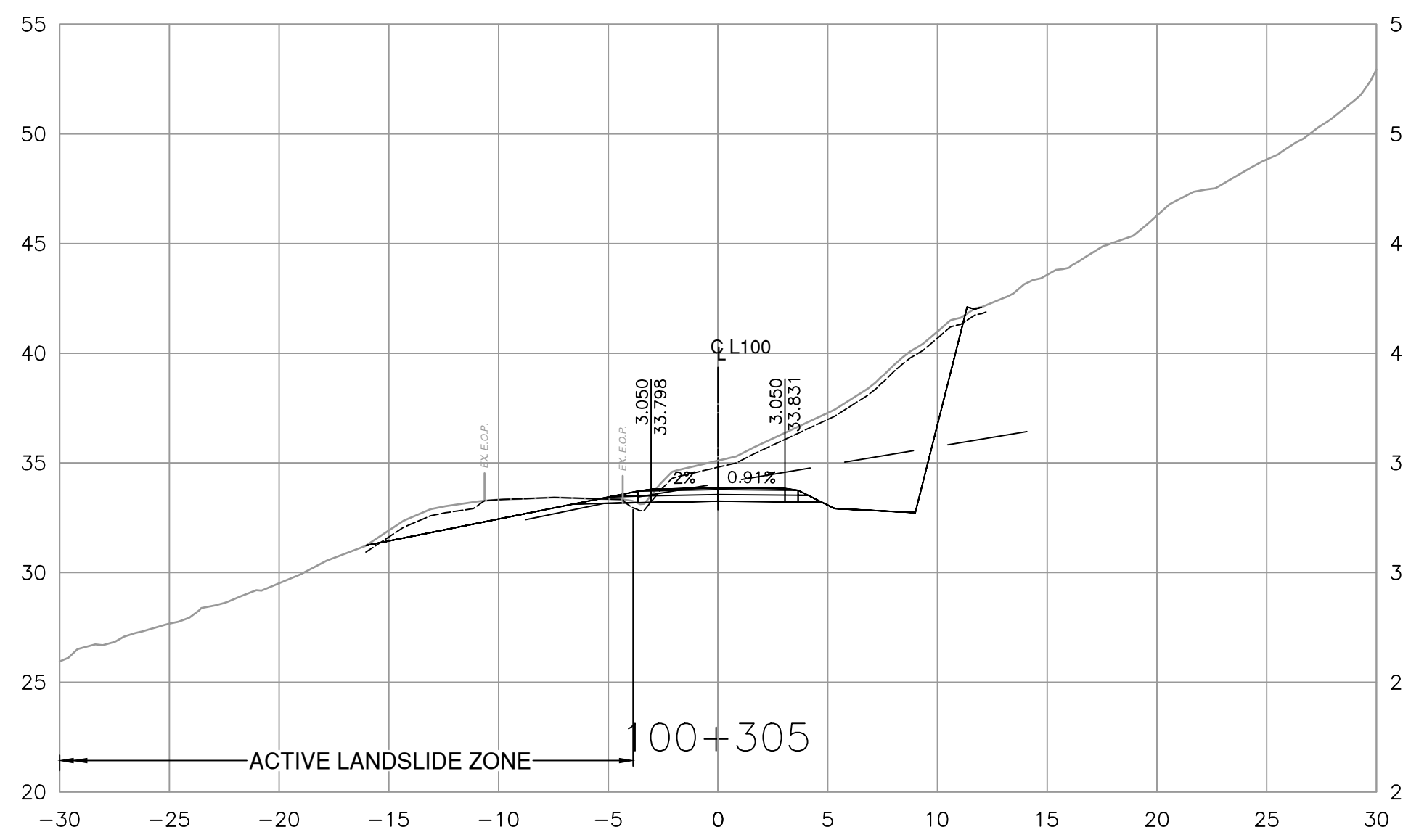
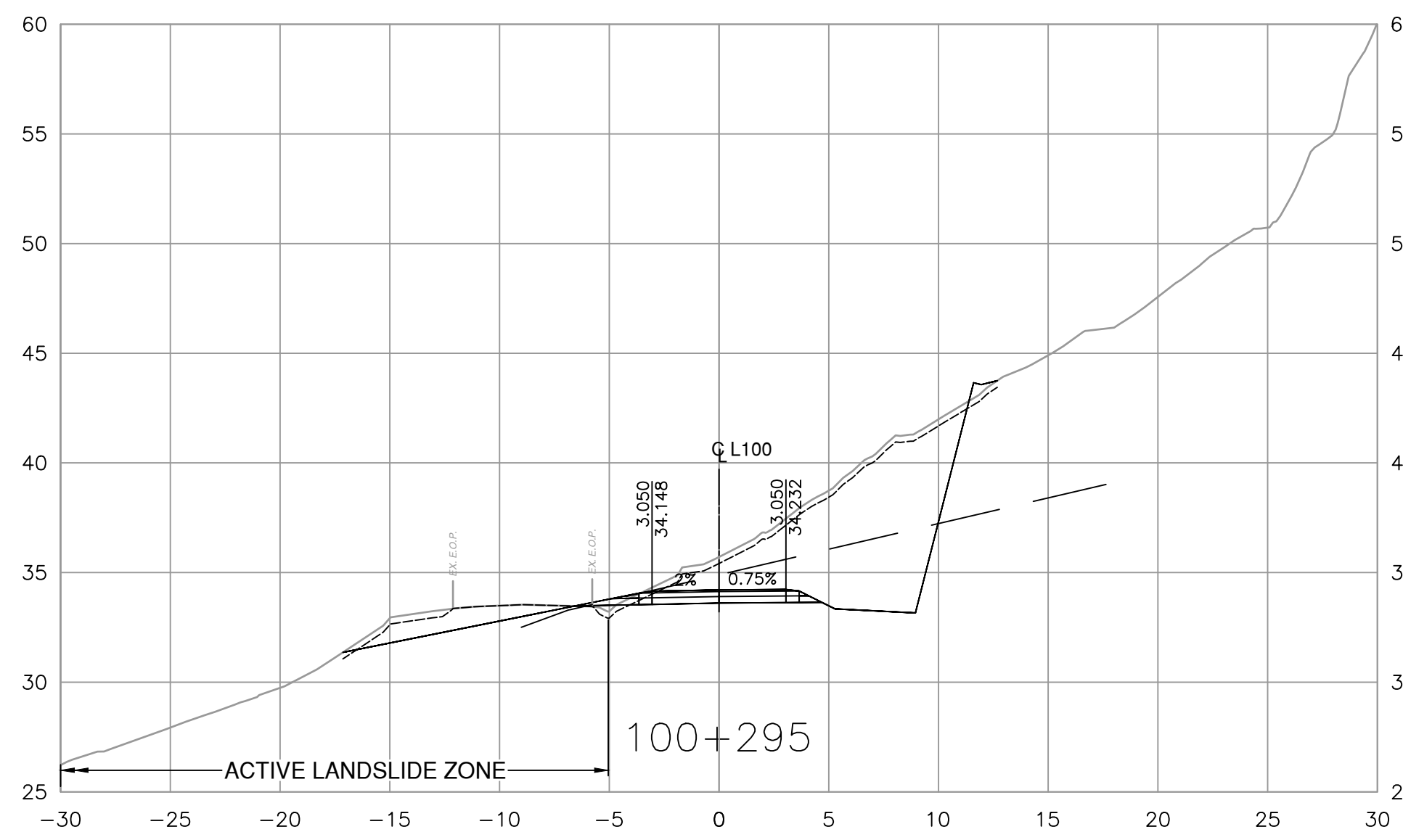

FOR REFERENCE ONLY



Suite 200
 858 Beatty Street
 Vancouver BC
 Canada V6B 1C1
 Tel 604 683 8521

SCALE 0 2 1:250 12m

CAD FILENAME: R1-1025-1000
 PLOT DATE: 9/28/2023

REV	DATE	REVISIONS	NAME



BRITISH COLUMBIA
 MINISTRY OF TRANSPORTATION
 AND INFRASTRUCTURE
 SOUTH COAST REGION
 HIGHWAY ENGINEERING AND GEOMATICS

J. PINTO
 SENIOR DESIGNER
 DATE: 2023-09-29

DESIGNED: A. PAN DATE: 2023-09-29
 QUALITY CONTROL: G. STEWART DATE: 2023-09-29
 QUALITY ASSURANCE: J. PINTO DATE: 2023-09-29
 DRAWN: G. HAROON DATE: 2023-09-29



CROSS SECTIONS
 CANAL ROAD DIP SLIDE
 SOUTH PENDER ISLAND

STA. 100+290.000 TO STA. 100+315.000

FILE NUMBER	PROJECT NUMBER	REG	DRAWING NUMBER	REV
2121-00865-09	18102-0000	1	R1-1025-1006	-

PRINTED: September 28, 2023 - 4:13 PM
 CAD FILE: X:\21212-18102-000\1011 - Canal Road Remediation\10.0 DRAWINGS\10.3 Engineering\CanalRoad\Drawings\Production\1003_Design\SectionR1-1025-1007.dwg (LAST SAVED: Gharoon)

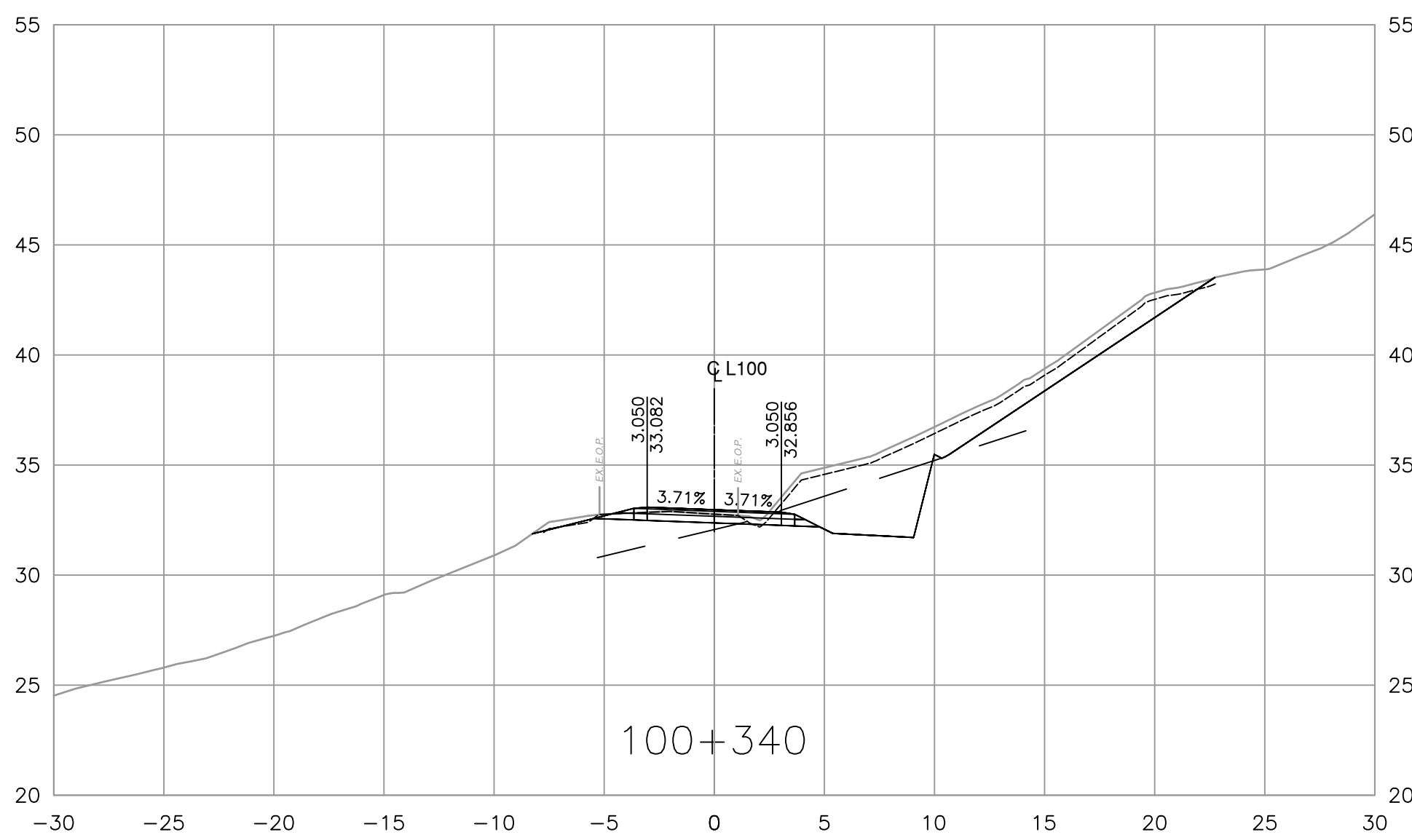
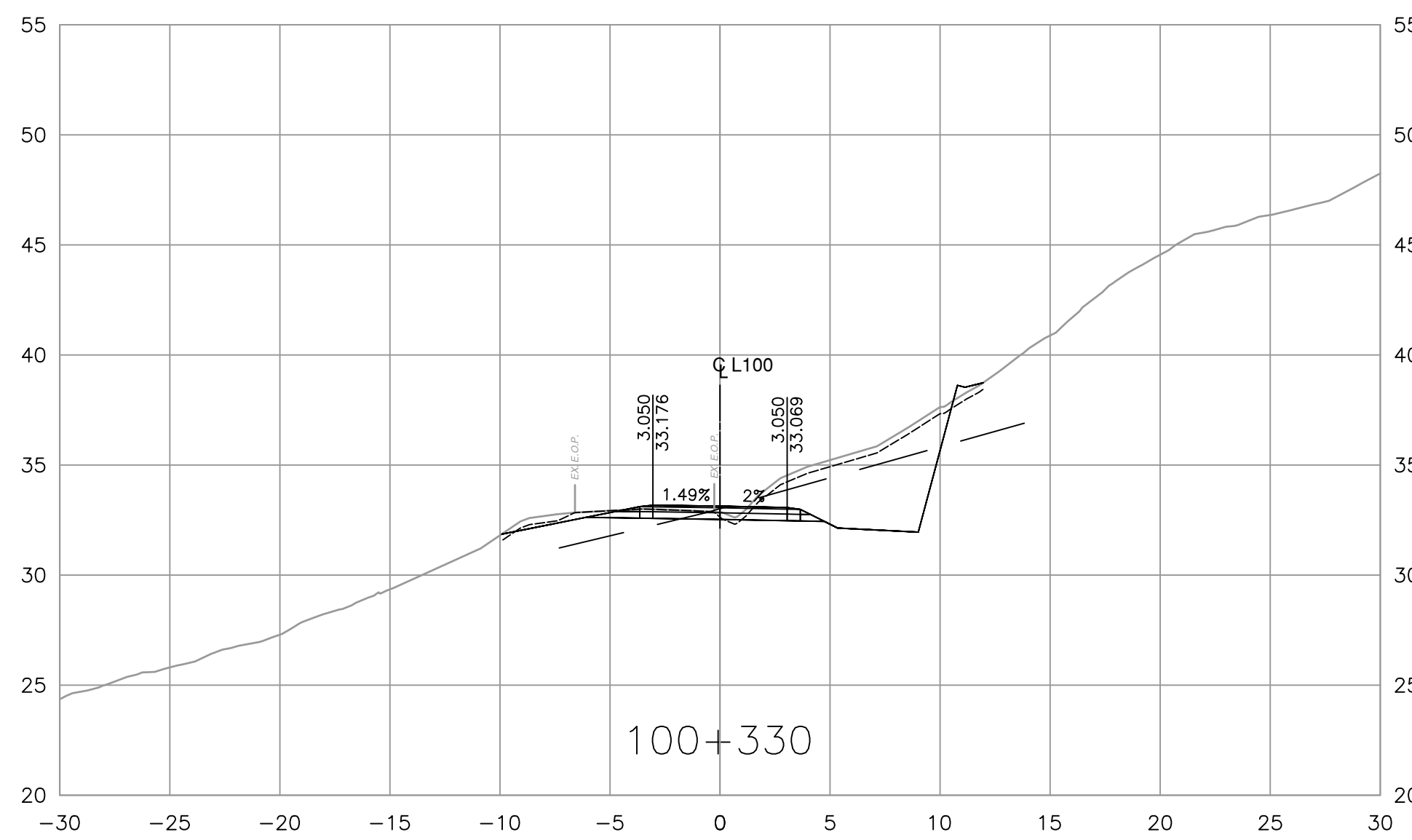
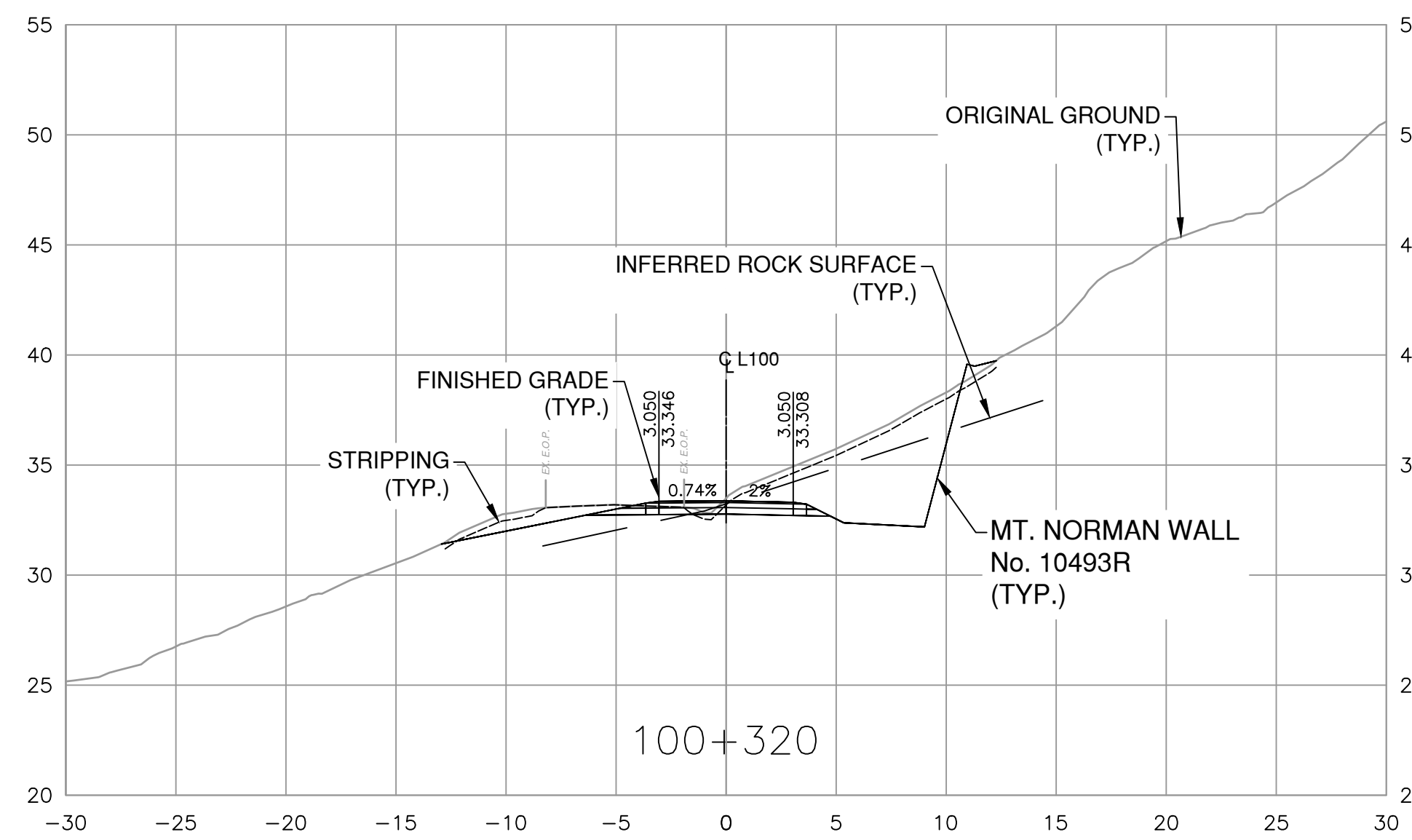
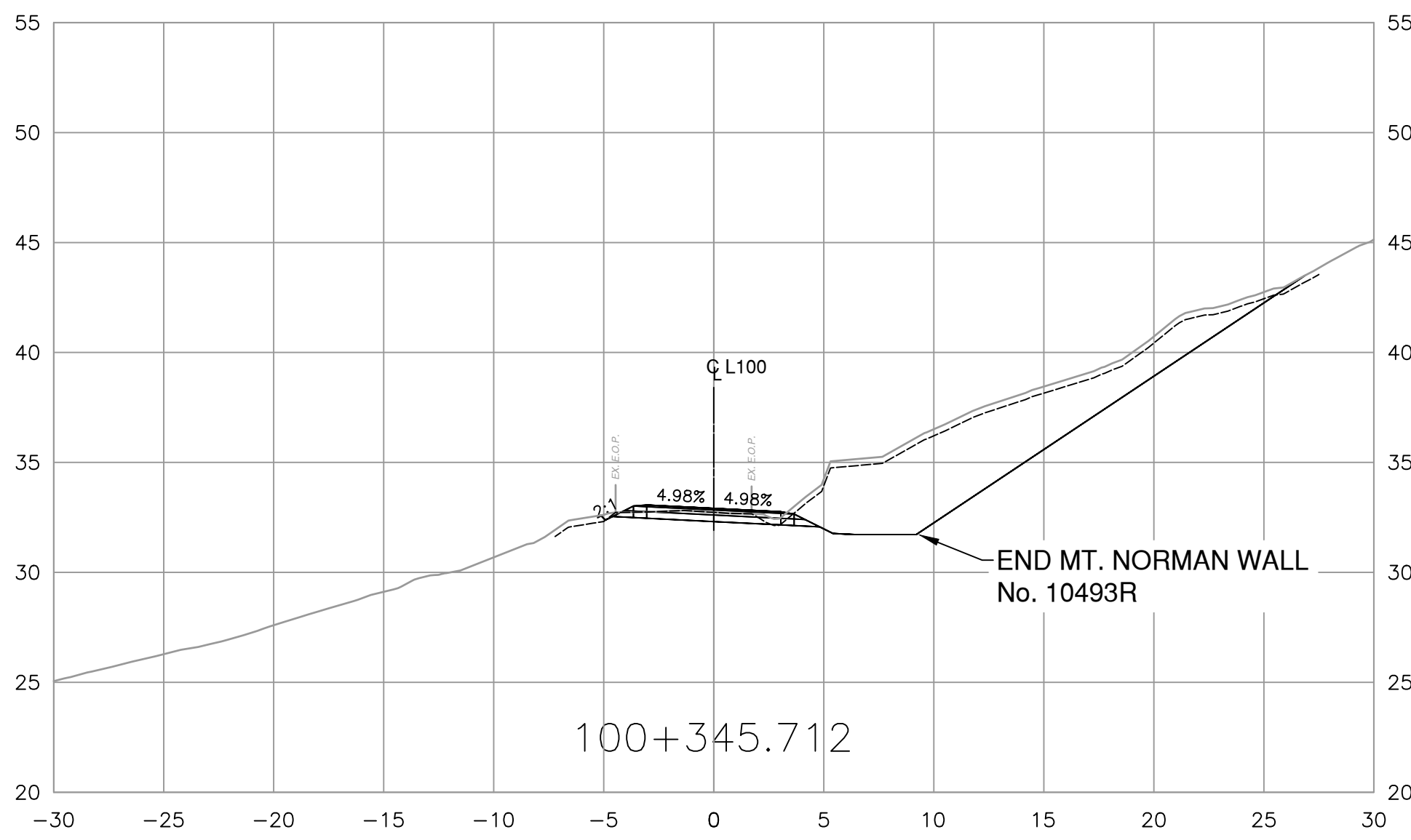
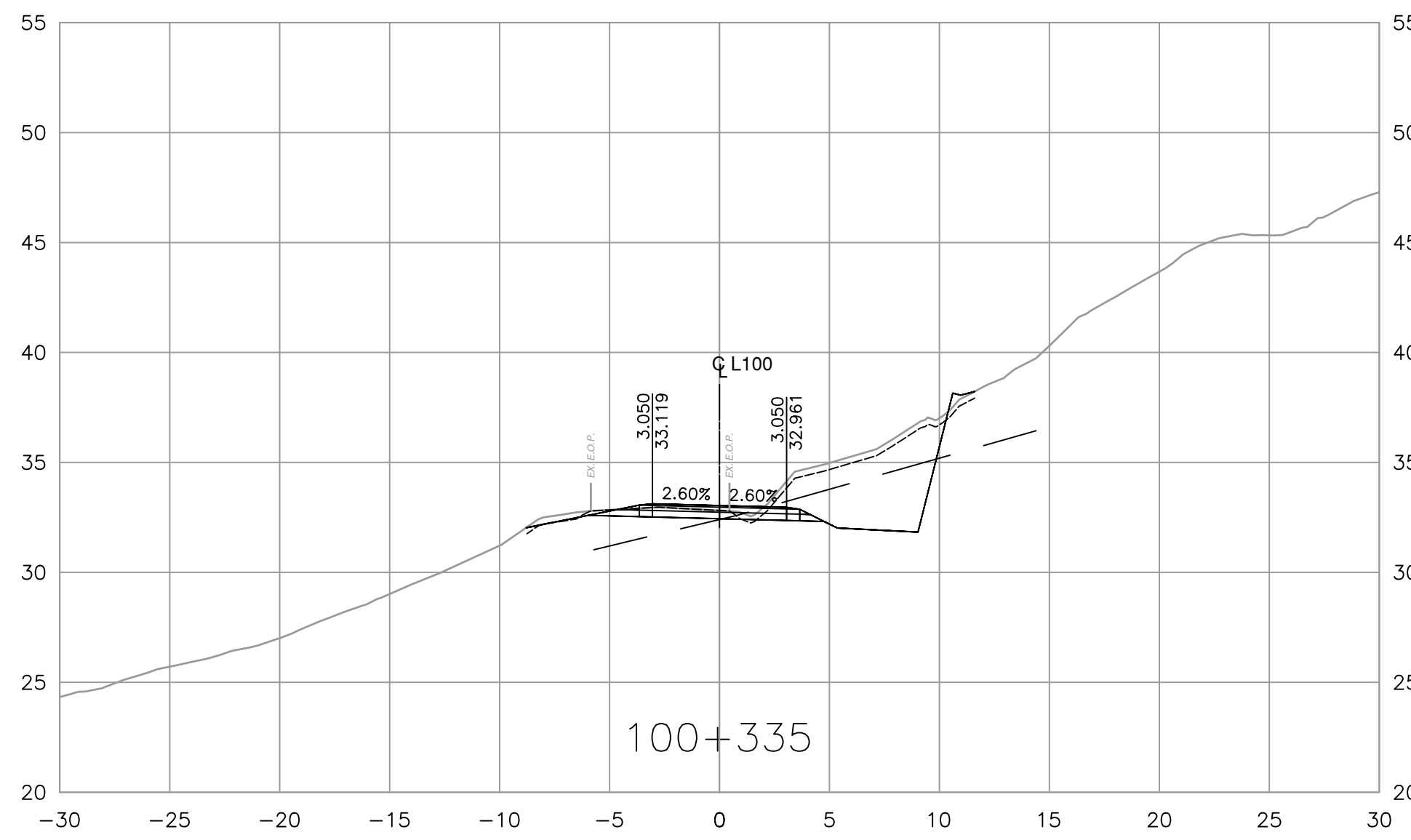
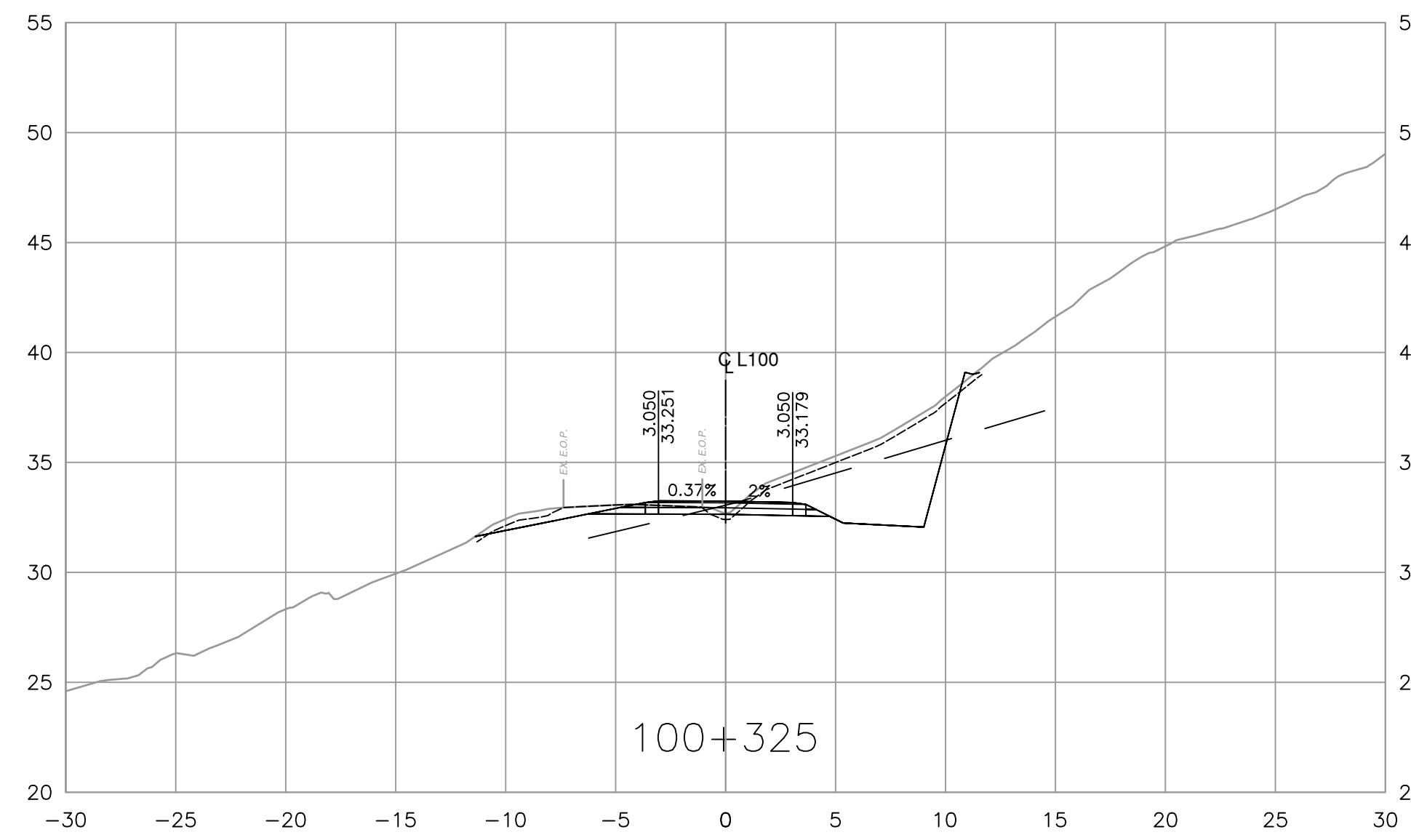

FOR REFERENCE ONLY



Suite 200
 858 Beatty Street
 Vancouver BC
 Canada V6B 1C1
 Tel 604 683 8521

SCALE 0 2 1:250 12m

CAD FILENAME: R1-1025-1000
 PLOT DATE: 9/28/2023

REV	DATE	REVISIONS	NAME



BRITISH COLUMBIA
 MINISTRY OF TRANSPORTATION AND INFRASTRUCTURE
 SOUTH COAST REGION
 HIGHWAY ENGINEERING AND GEOMATICS

J. PINTO
 SENIOR DESIGNER
 DATE: 2023-09-29

DESIGNED: A. PAN DATE: 2023-09-29
 QUALITY CONTROL: G. STEWART DATE: 2023-09-29
 QUALITY ASSURANCE: J. PINTO DATE: 2023-09-29
 DRAWN: G. HAROON DATE: 2023-09-29



CROSS SECTIONS
 CANAL ROAD DIP SLIDE
 SOUTH PENDER ISLAND

STA. 100+320.000 TO STA. 100+345.712

FILE NUMBER	PROJECT NUMBER	REG	DRAWING NUMBER	REV
2121-00865-09	18102-0000	1	R1-1025-1007	-

PRINTED: September 28, 2023 - 4:13 PM
 CAD FILE: X:\212100865-09\1- Canal Road Remediation\10.0 DRAWINGS\10.3 Engineering\CanalRoad\DrawingProduction\1003_Design\Sections\R1-1025-1008.dwg (LAST SAVED: Chahoon)

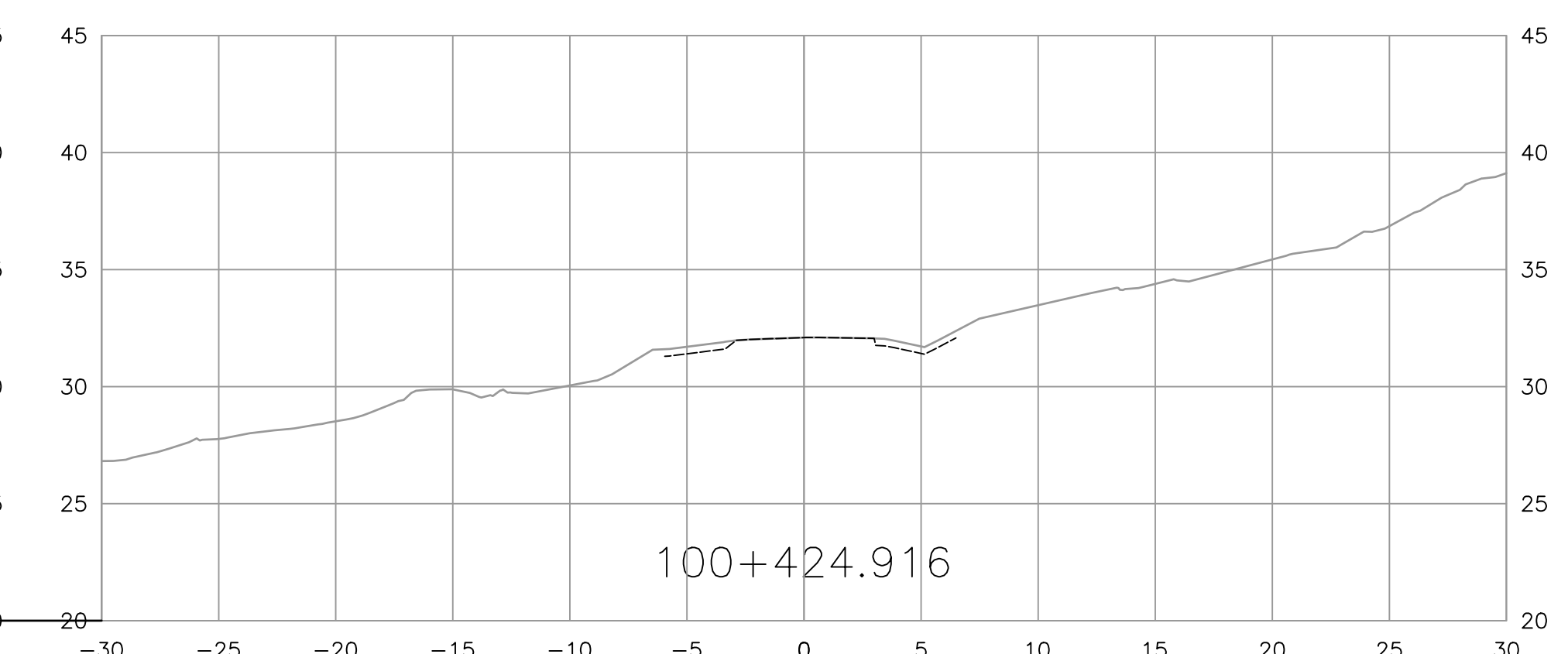
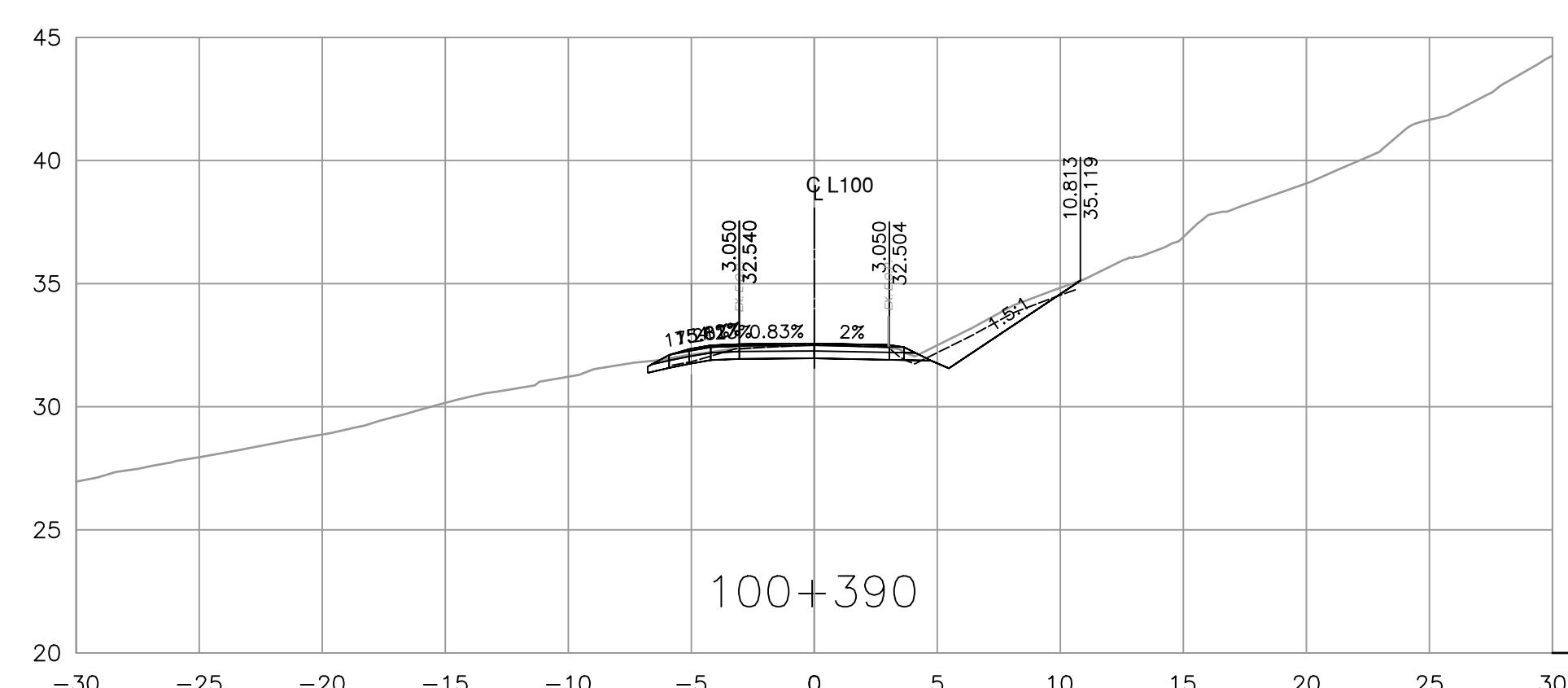
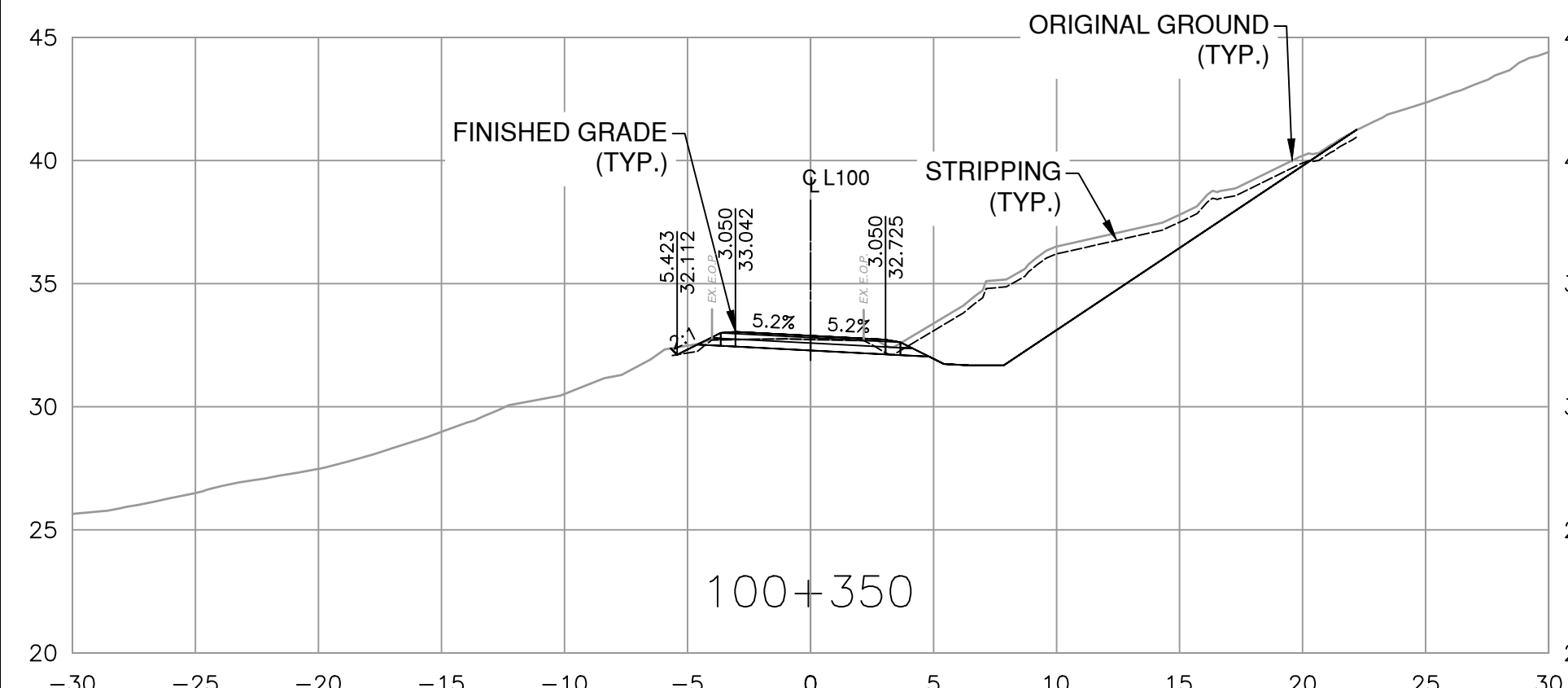
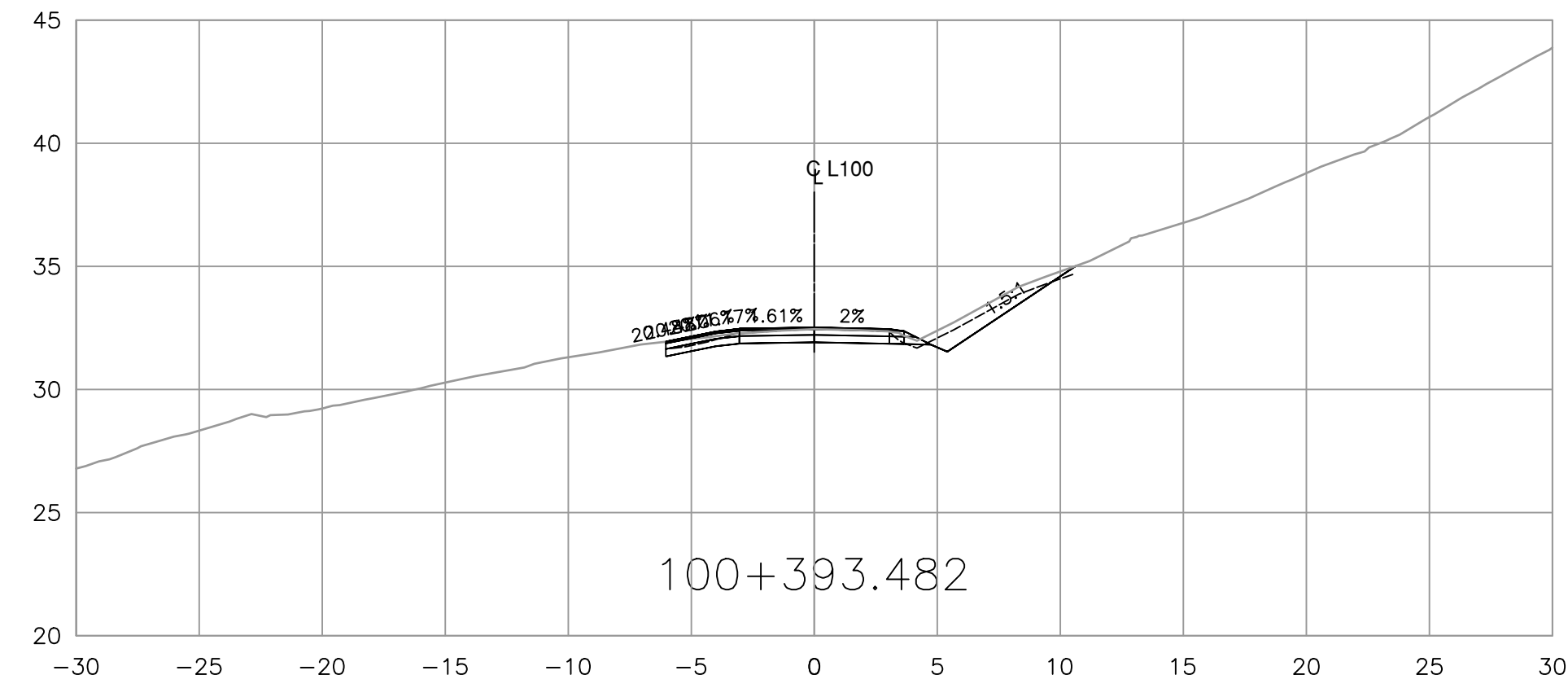
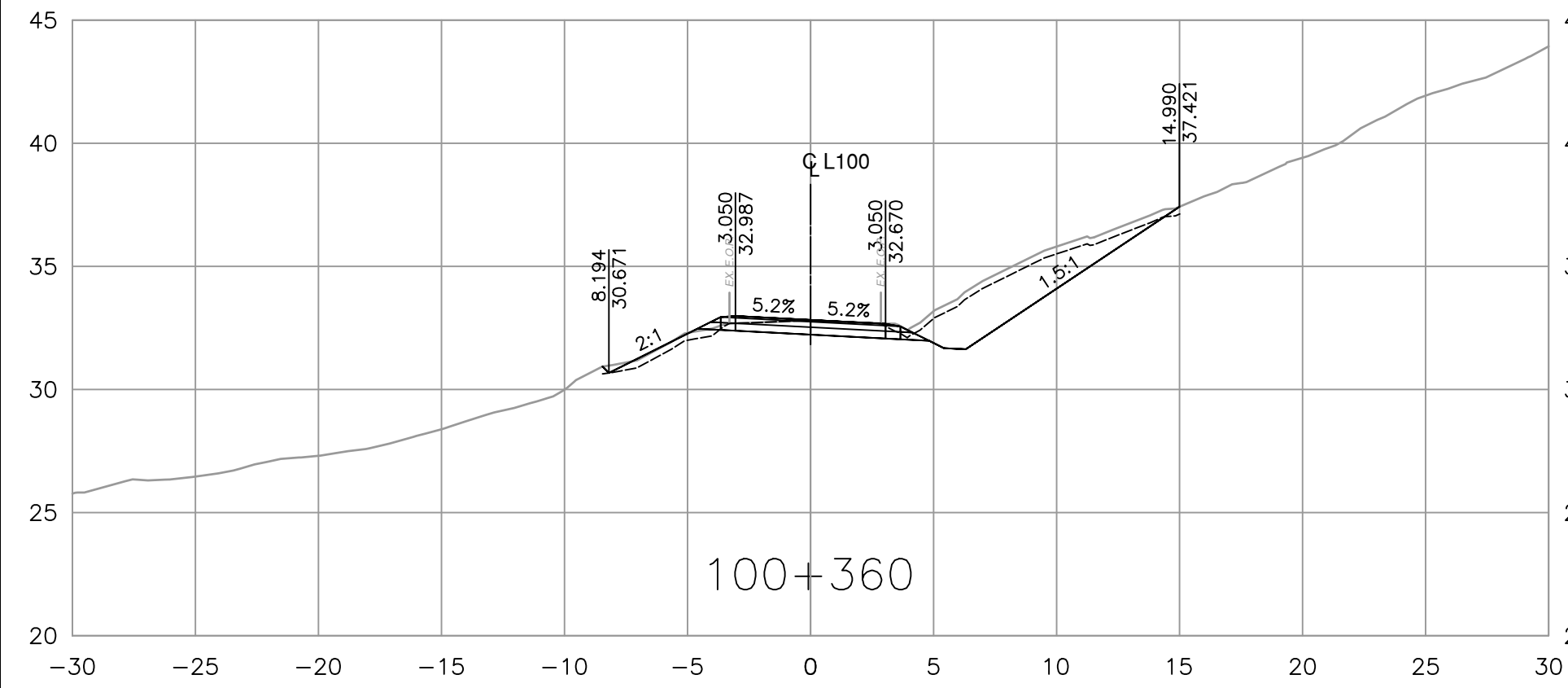
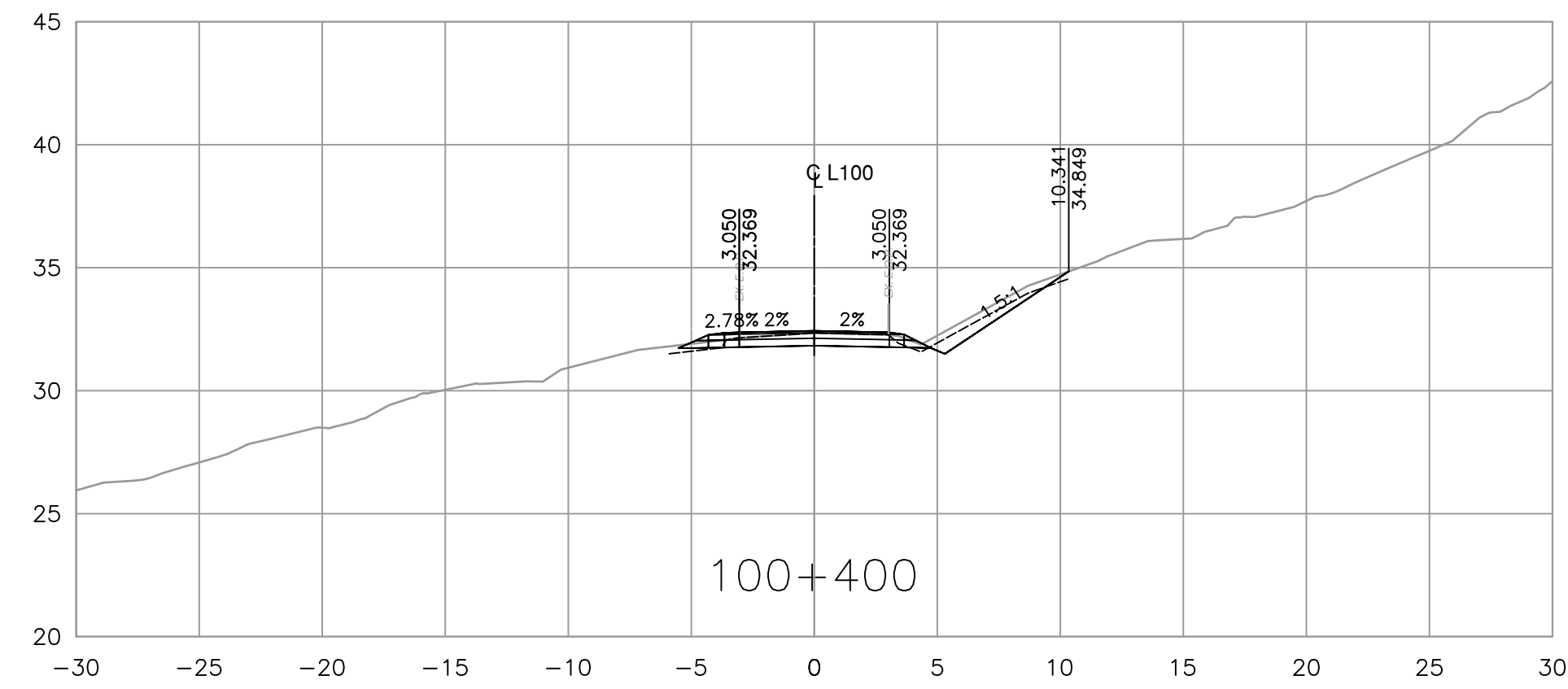
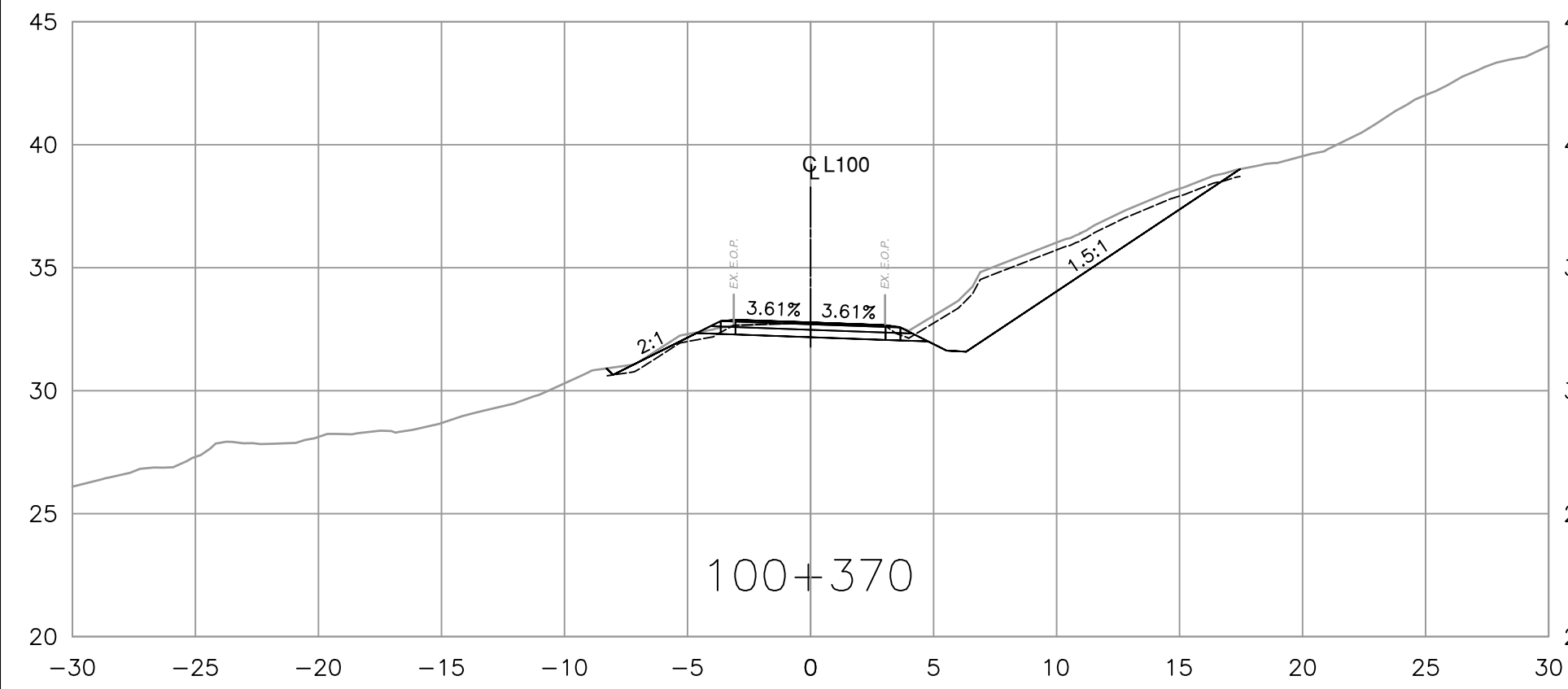
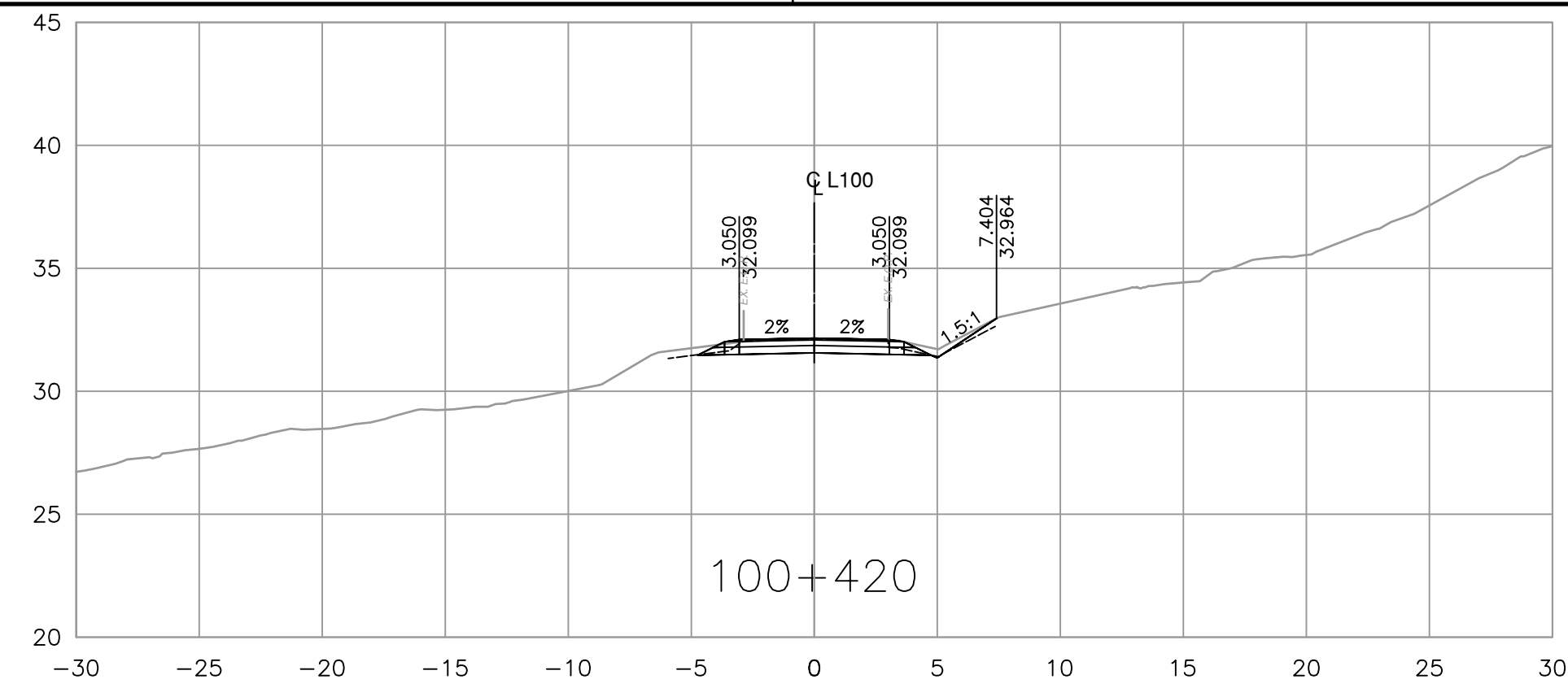
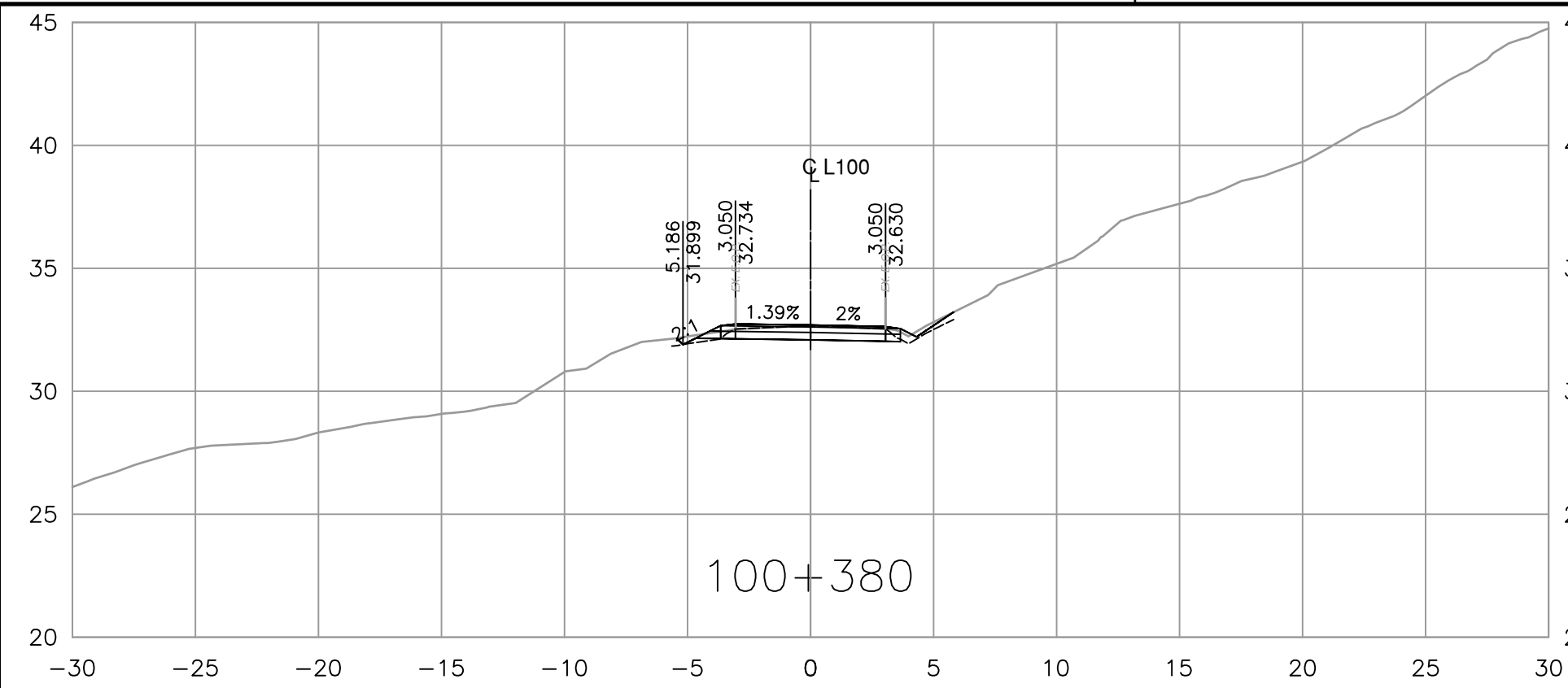

FOR REFERENCE ONLY



Suite 200
 858 Beatty Street
 Vancouver BC
 Canada V6B 1C1
 Tel 604 683 8521

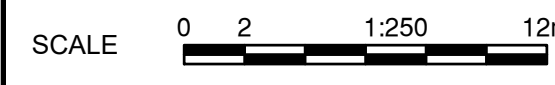

CAD FILENAME: R1-1025-1000
 PLOT DATE: 9/28/2023

REV	DATE	REVISIONS	NAME



BRITISH COLUMBIA
 MINISTRY OF TRANSPORTATION
 AND INFRASTRUCTURE
 SOUTH COAST REGION
 HIGHWAY ENGINEERING AND GEOMATICS

J. PINTO
 SENIOR DESIGNER
 DATE: 2023-09-29

DESIGNED: A. PAN DATE: 2023-09-29
 QUALITY CONTROL: G. STEWART DATE: 2023-09-29
 QUALITY ASSURANCE: J. PINTO DATE: 2023-09-29
 DRAWN: G. HAROON DATE: 2023-09-29

CROSS SECTIONS			
CANAL ROAD DIP SLIDE			
SOUTH PENDER ISLAND			
STA. 100+350.000 TO 100+429.917			
FILE NUMBER	PROJECT NUMBER	REG	DRAWING NUMBER
2121-00865-09	18102-0000	1	R1-1025-1008

PRINTED: November 1, 2023, 11:41 AM
 CAD FILE: X:\21212-18102-000\1 - Canal Road Remediation\10.0 DRAWINGS\10.3 Engineering\Pender Barge\Drawings\Production\1000_DesignSections\R1-1000.dwg (LAST SAVED: JAPAN)

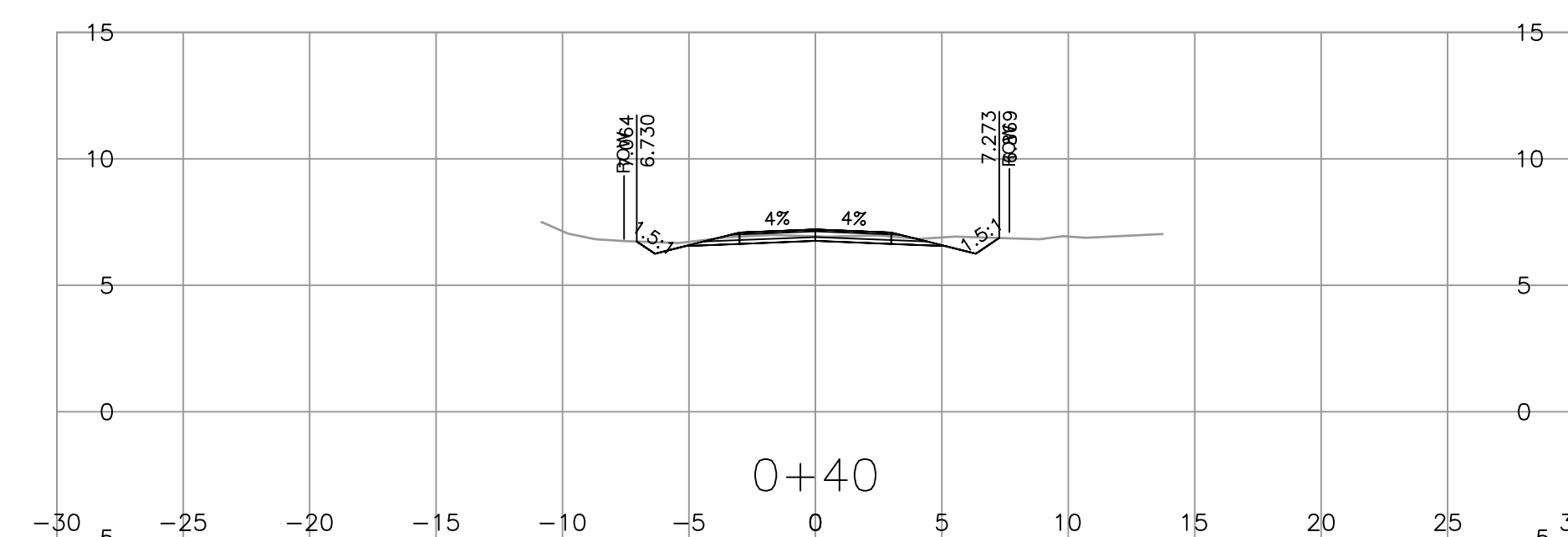
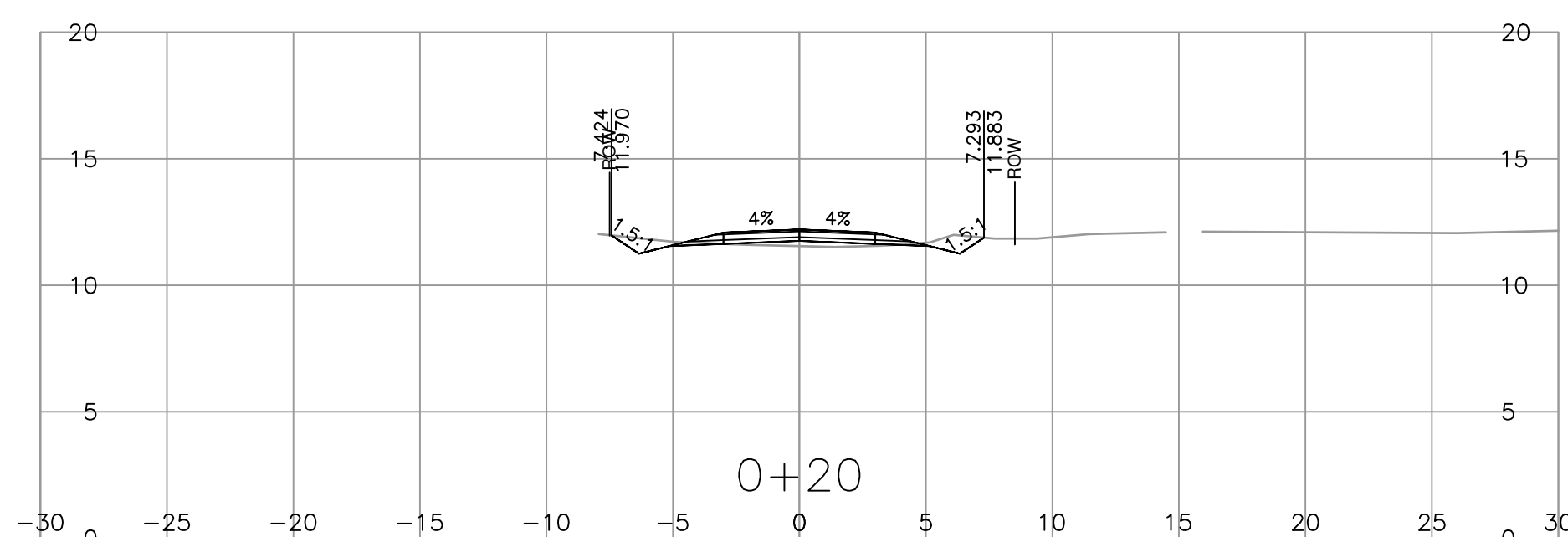
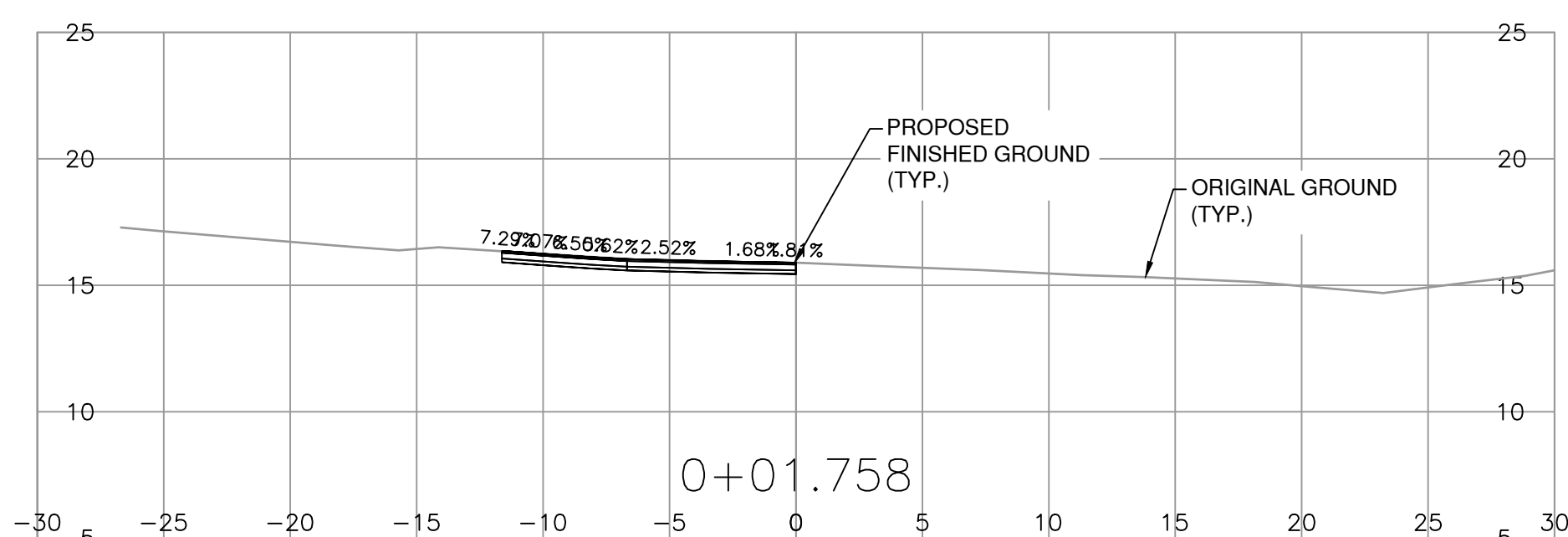
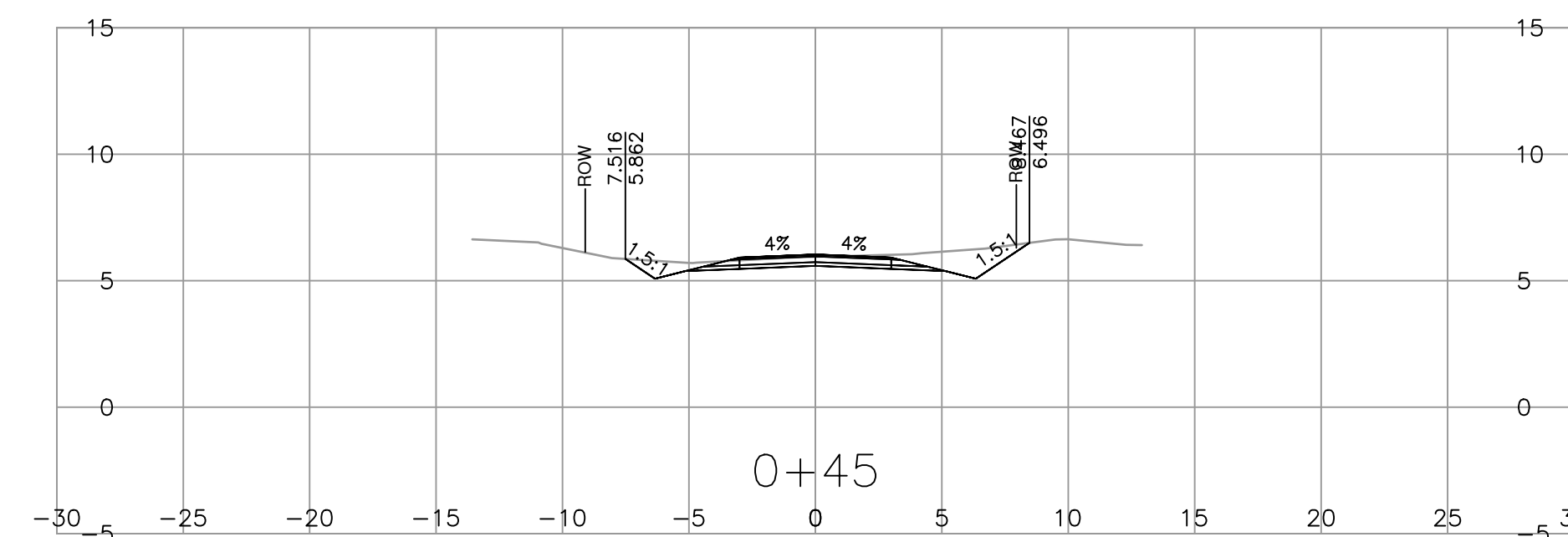
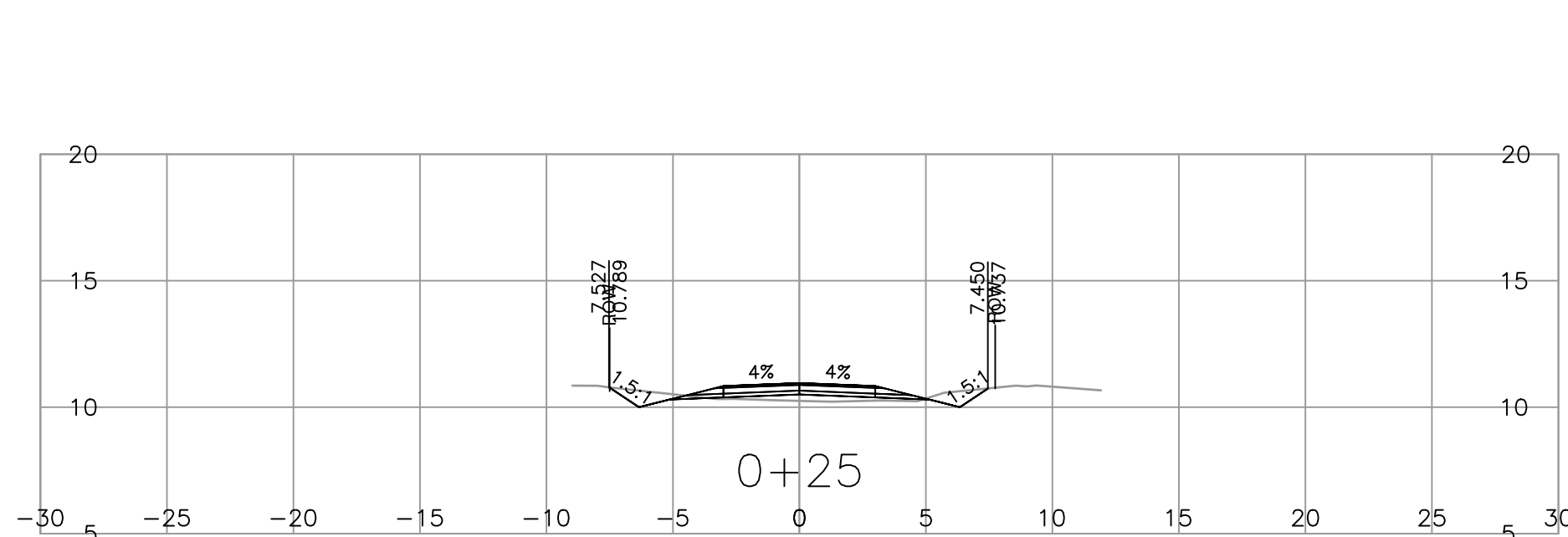
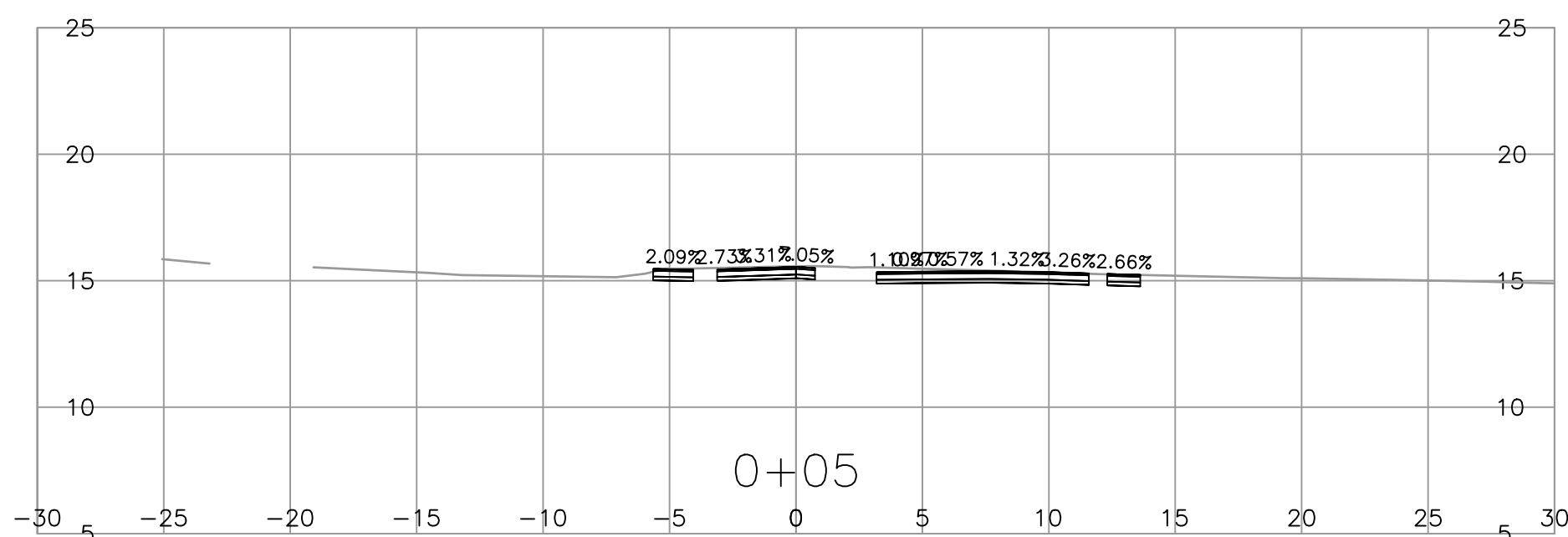
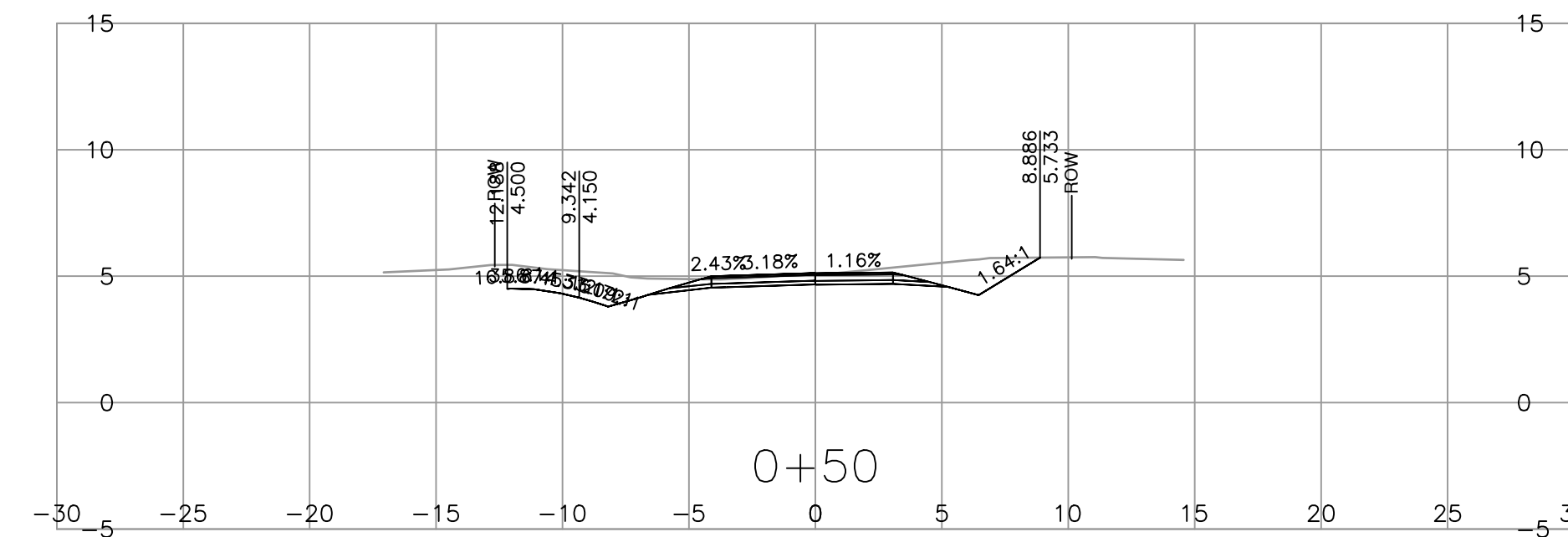
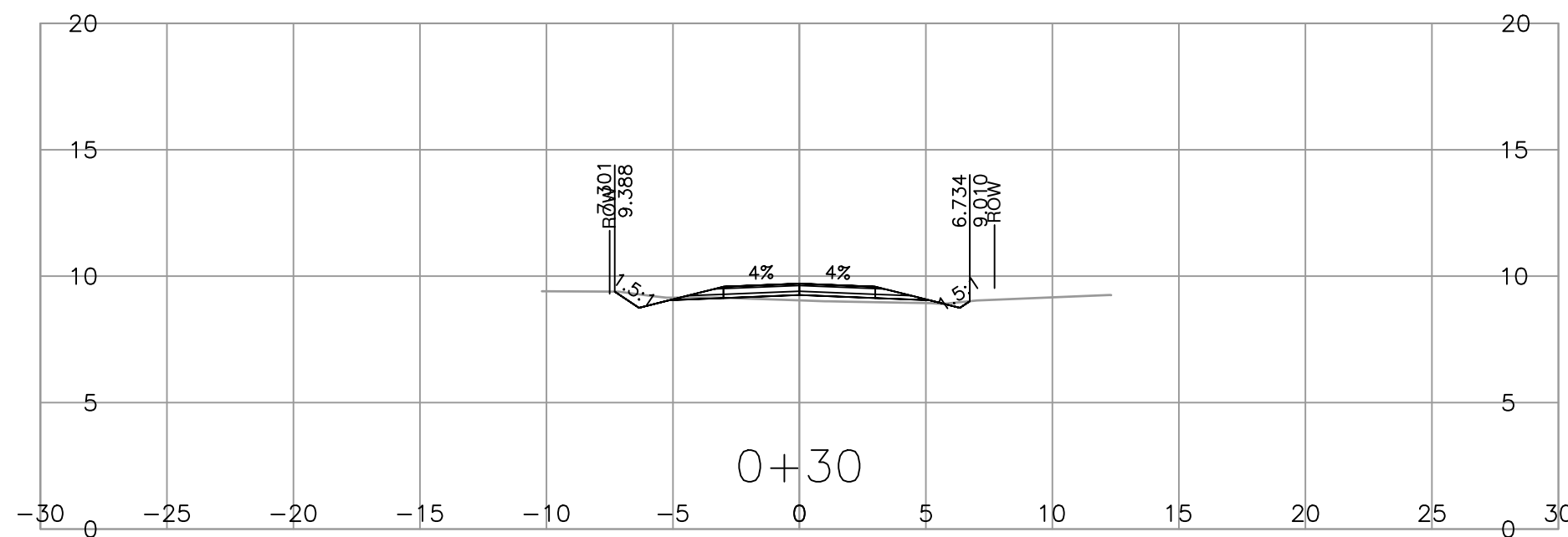
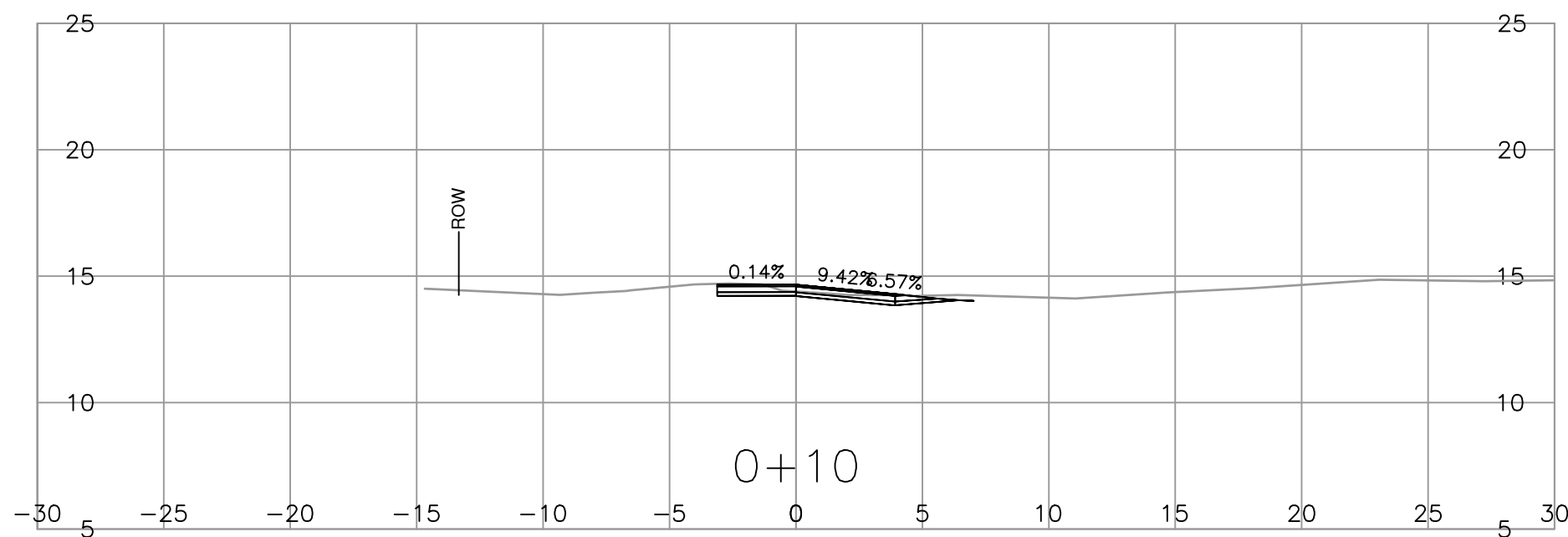
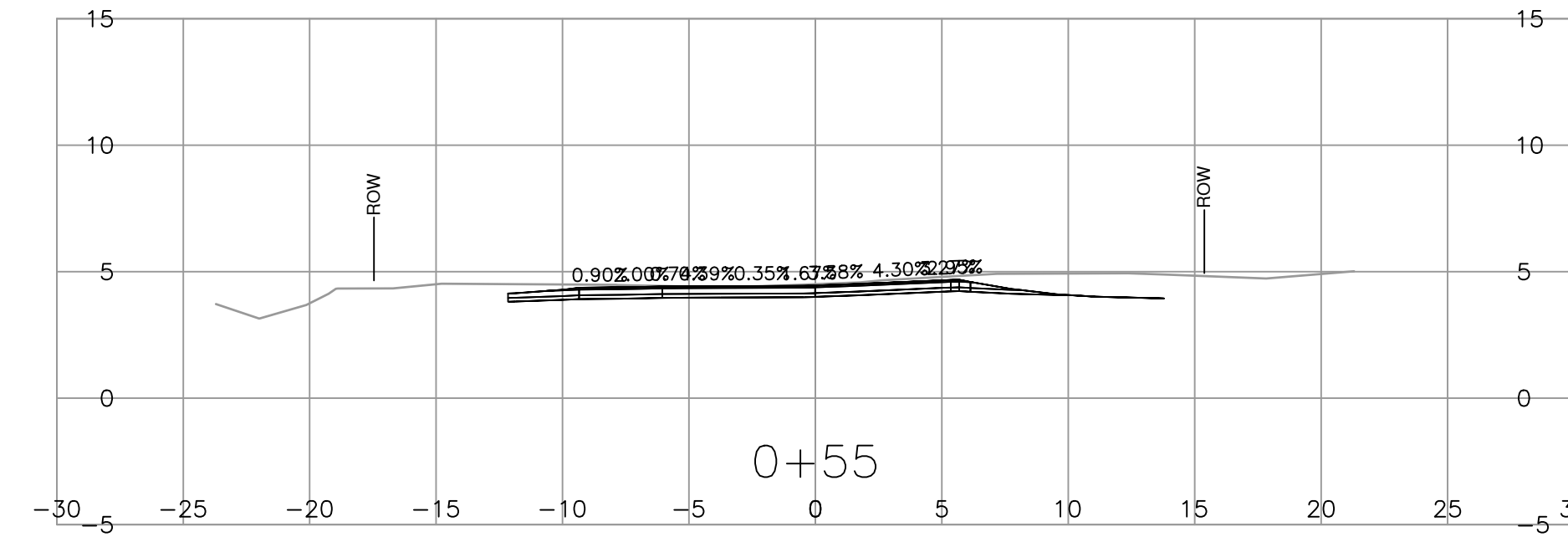
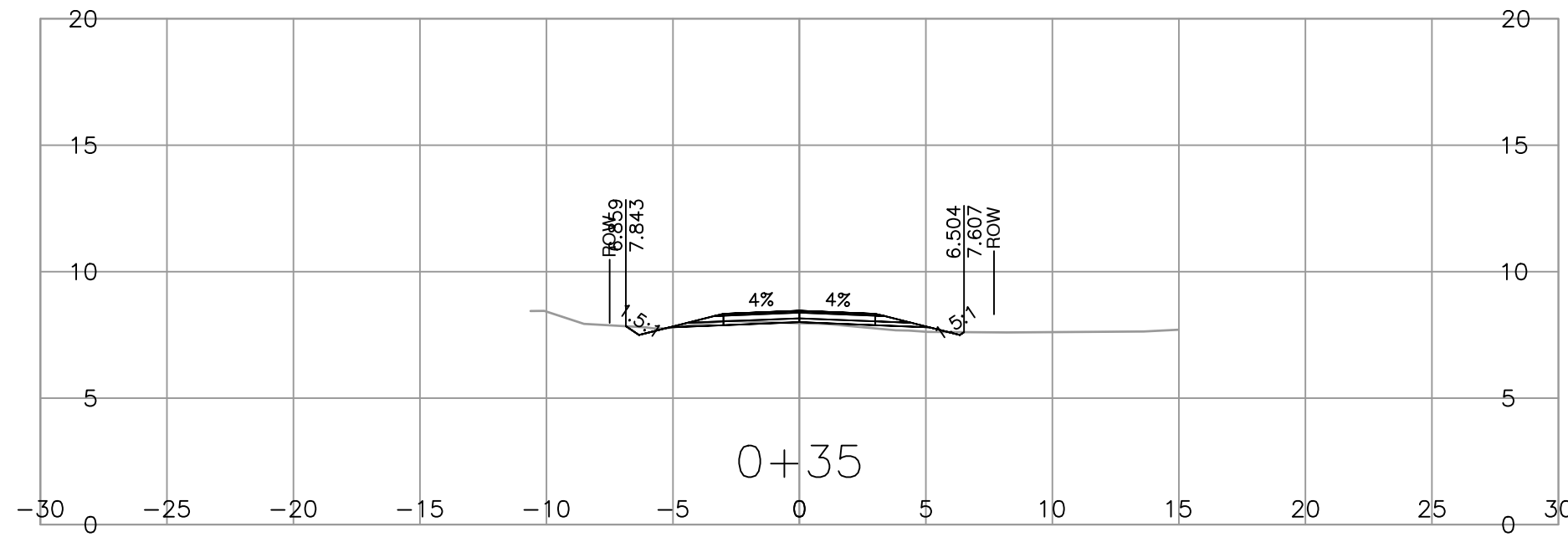
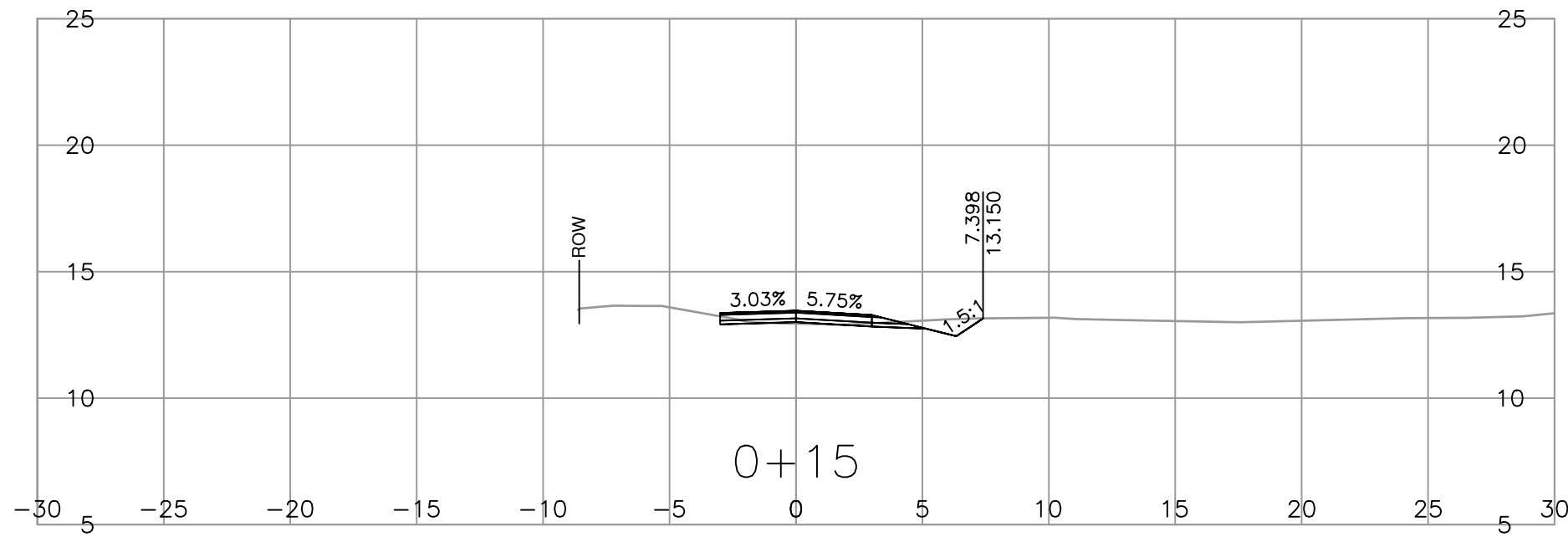

FOR REFERENCE ONLY



Suite 200
858 Beatty Street
Vancouver BC
Canada V6B 1C1
Tel 604 683 8521

CAD FILENAME: R1-1000-1000
PLOT DATE: 11/11/2023

SCALE

REV	DATE	REVISIONS	NAME
A	YYYY-MM-DD		



MINISTRY OF TRANSPORTATION
AND INFRASTRUCTURE
SOUTH COAST REGION
HIGHWAY ENGINEERING AND GEOMATICS

K. LEGGETT
SENIOR DESIGNER

DESIGNED: A. PAN DATE: 2023-09-29
 QUALITY CONTROL: G. STEWART DATE: 2023-09-29
 QUALITY ASSURANCE: J. PINTO DATE: 2023-09-29
 DRAWN: G. HAROON DATE: 2023-09-29



PENDER BARGE - CROSS SECTIONS

PENDER BARGE ACCESS
SOUTH PENDER ISLAND
STA. 0+01.758 TO 0+55.000

FILE NUMBER	PROJECT NUMBER	REG	DRAWING NUMBER	REV
2121-00865-09	18102-0000	1	R1-1025-1009	-

PRINTED: October 3, 2023 - 2:17 PM
 CAD FILE: X:\2121-00865-09\001 - Canal Road Remanifestion\10.0 DRAWINGS\10.3 Engineering\Pender Barge\Crossing\Pender Barge\Crossing\Production\1000_Design\Sections\R1-NNN-1000.dwg (LAST SAVED: Gharoon)

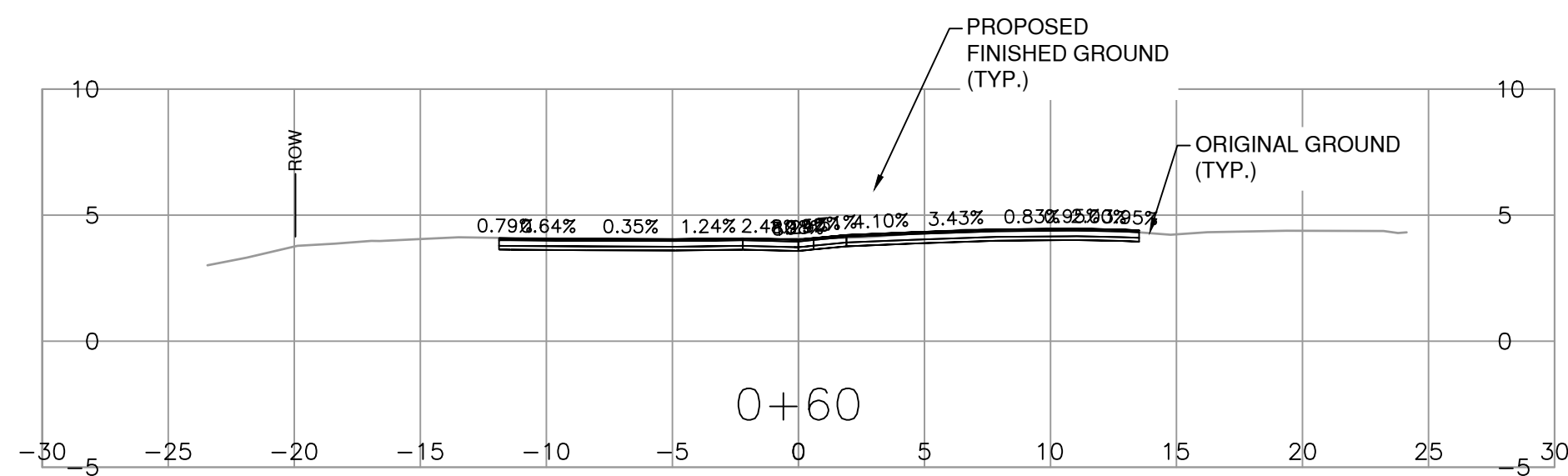
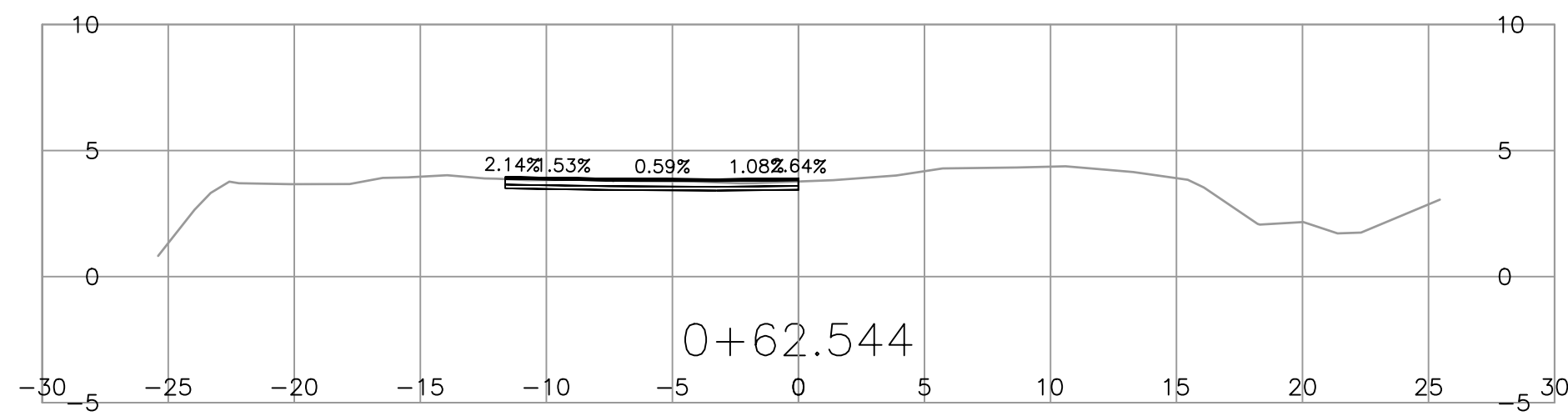

FOR REFERENCE ONLY



Suite 200
858 Beatty Street
Vancouver BC
Canada V6B 1C1
Tel 604 683 8521

CAD FILENAME: R1-NNN-1000
PLOT DATE: 10/3/2023

SCALE

REV	DATE	REVISIONS	NAME
A	YYYY-MM-DD		



MINISTRY OF TRANSPORTATION
AND INFRASTRUCTURE
SOUTH COAST REGION
HIGHWAY ENGINEERING AND GEOMATICS



K. LEGGETT
SENIOR DESIGNER
DATE: 2023-09-29

DESIGNED: A. PAN DATE: 2023-09-29
 QUALITY CONTROL: G. STEWART DATE: 2023-09-29
 QUALITY ASSURANCE: J. PINTO DATE: 2023-09-29
 DRAWN: G. HAROON DATE: 2023-09-29

PENDER BARGE - CROSS SECTIONS

PENDER BARGE ACCESS
SOUTH PENDER ISLAND
STA. 0+60.000 TO 0+68.476

FILE NUMBER	PROJECT NUMBER	REG	DRAWING NUMBER	REV
2121-00865-09	18102-0000	1	R1-1025-1010	-