



Ministry of
Transportation
and Infrastructure

PROJECT NO. 17065-0001

CROSS SECTIONS SET

HIGHWAY No. 1

COLQUITZ BRIDGES RETROFIT AND BUS LANE EXTENSION

DRAFT

IAN PILKINGTON, CHIEF ENGINEER

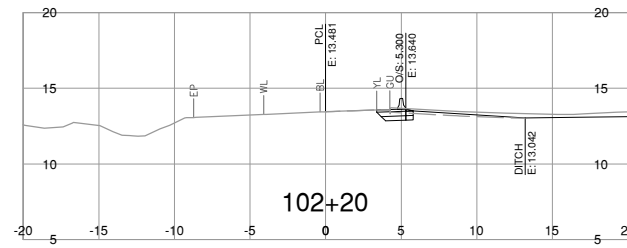
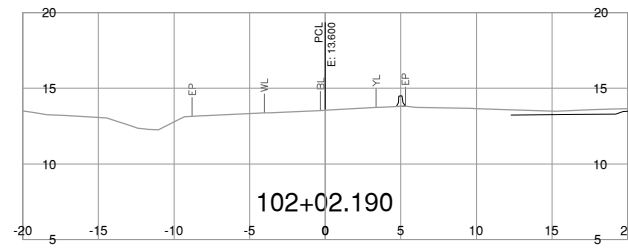
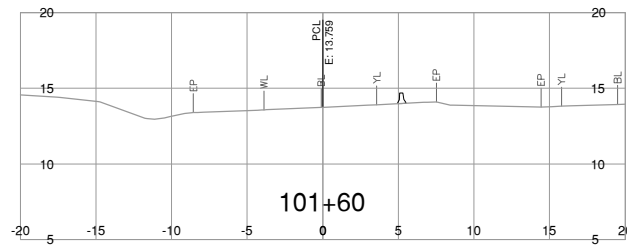
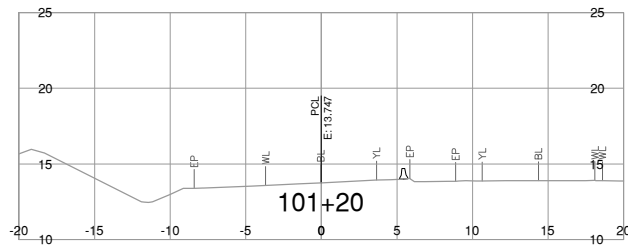
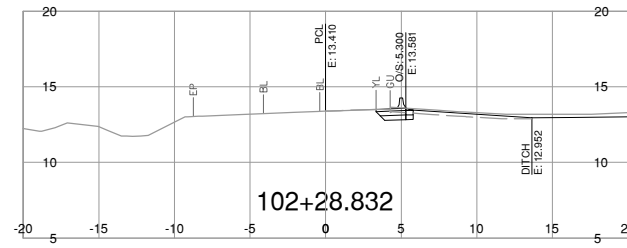
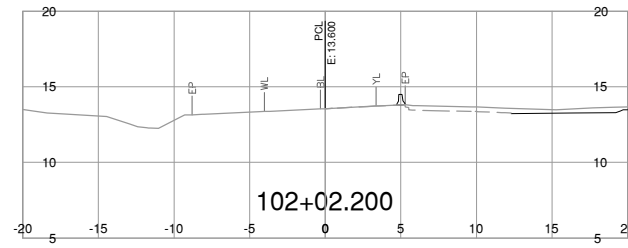
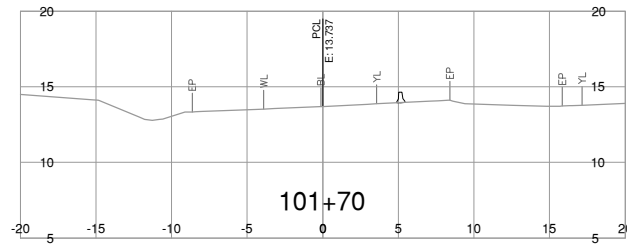
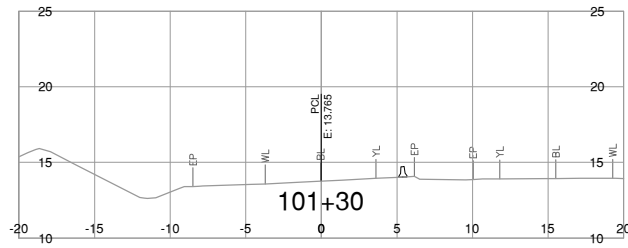
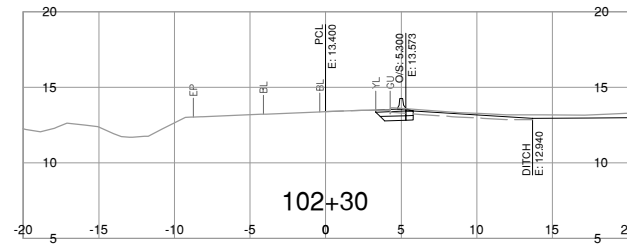
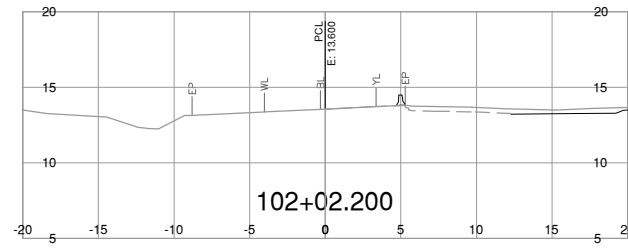
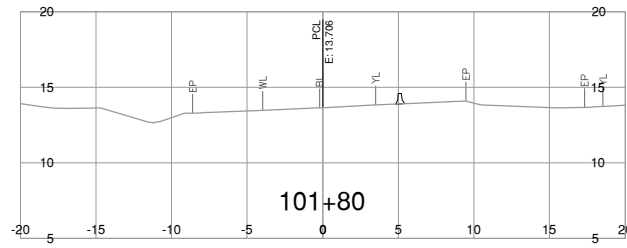
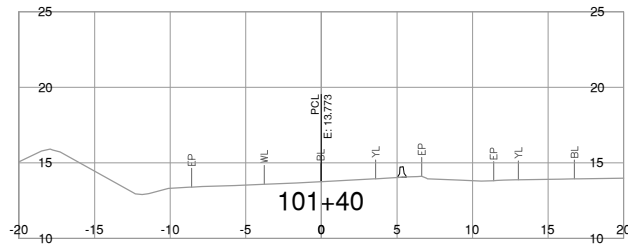
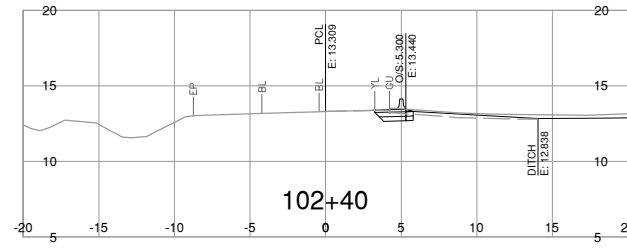
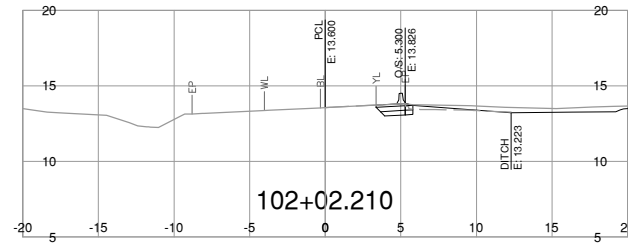
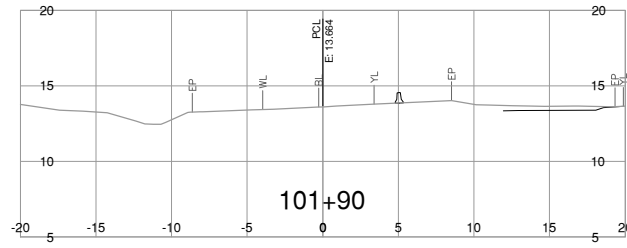
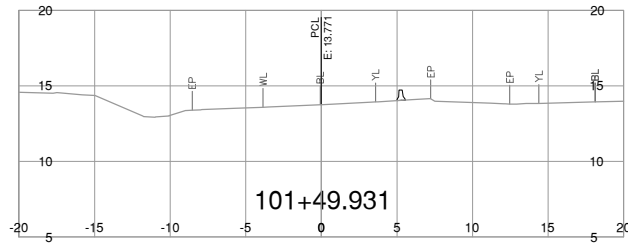
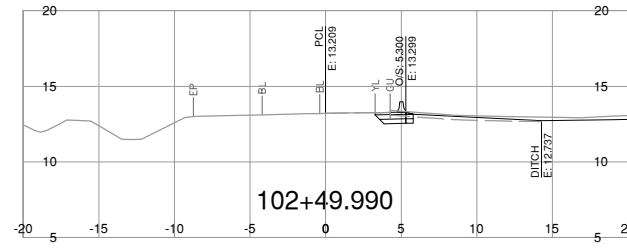
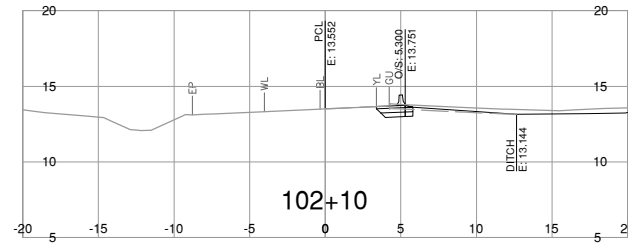
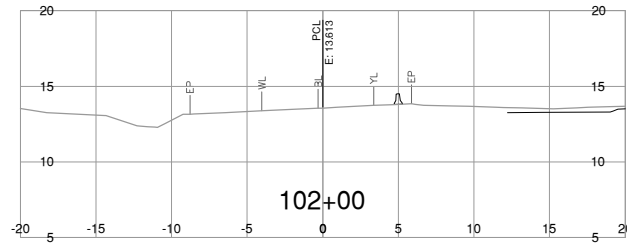
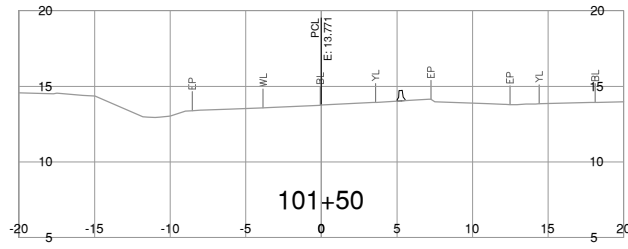

NOTE: STRIPPING REMOVAL APPLIES ONLY TO THE AREA BETWEEN SLOPE STAKE LINES (TOES & TOP OF CUT) OF PROPOSED ROADWAY TEMPLATE

FOR REFERENCE ONLY

DRAFT



BINNIE
The people behind your infrastructure.

R.F. BINNIE & ASSOCIATES LTD.
300 - 4940 Canada Way,
Burnaby, BC V5G 4K6
TEL 604 420 1721
BINNIE.com



BRITISH COLUMBIA
MINISTRY OF TRANSPORTATION AND INFRASTRUCTURE
SOUTH COAST REGION
HIGHWAY ENGINEERING AND GEOMATICS

L100-LINE CROSS SECTIONS
HIGHWAY No. 1
COLQUITZ BRIDGES RETROFIT AND BUS LANE EXTENSION

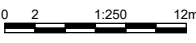
SCALE  CAD FILENAME SECT-L100-22-0393.DWG
DATE 2023-09-28
FILE NUMBER 22-0393

REV	DATE	REVISIONS	SIGNATURE

DESIGNED _____	M.C.	DATE <u>OCT 2023</u>
QUALITY CONTROL _____	M.C.	DATE <u>OCT 2023</u>
QUALITY ASSURANCE _____	M.C.	DATE <u>OCT 2023</u>
DRAWN _____	J.T.	DATE <u>OCT 2023</u>
PROJECT NUMBER 17065-0001	REG 1	DRAWING NUMBER R1-1060-L100XS-1

Sep 28, 2023 09:43 AM P:\2022\22-0393\100 - CAD Files\00-Collatz\Bridges\Drawing\Production\1000_DesignSections\SECT L100_22-0393

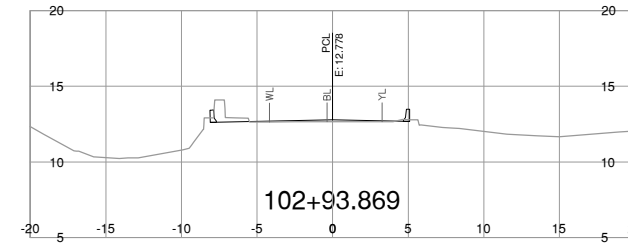
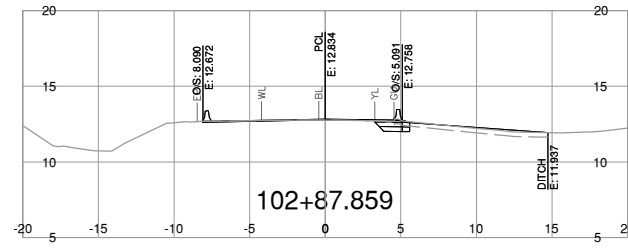
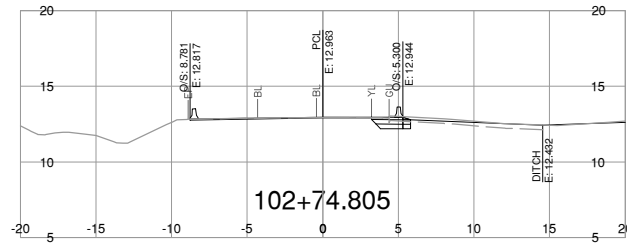
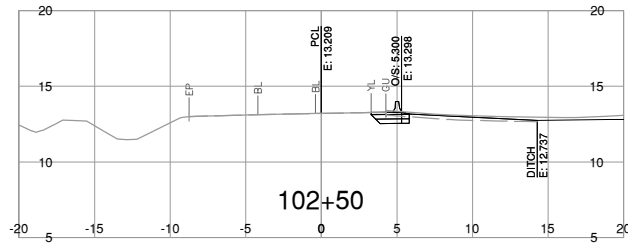
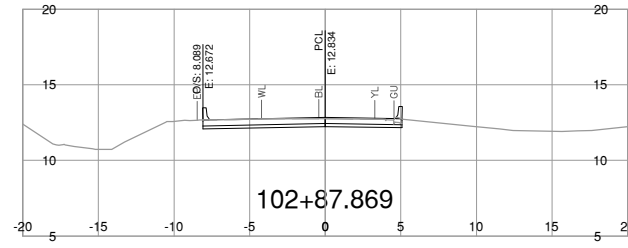
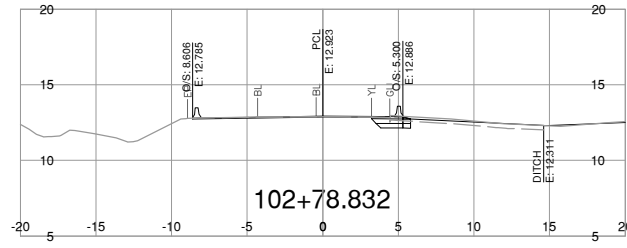
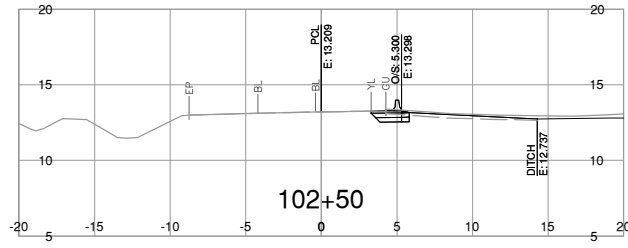
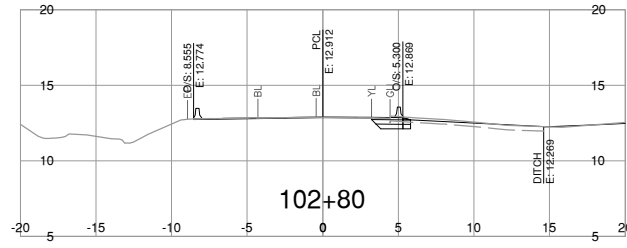
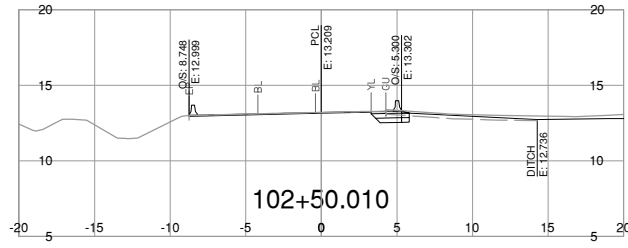
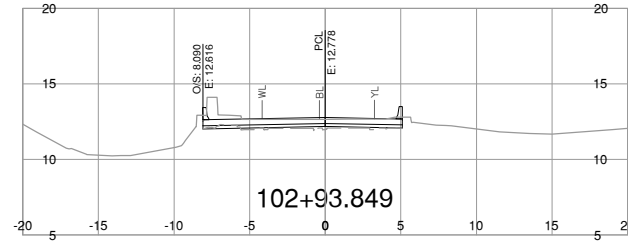
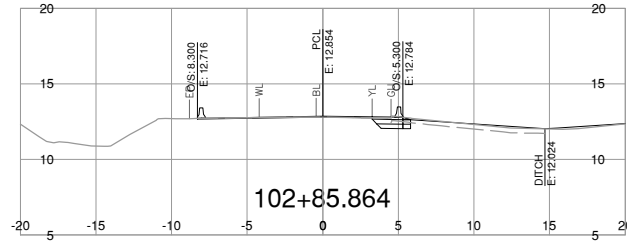
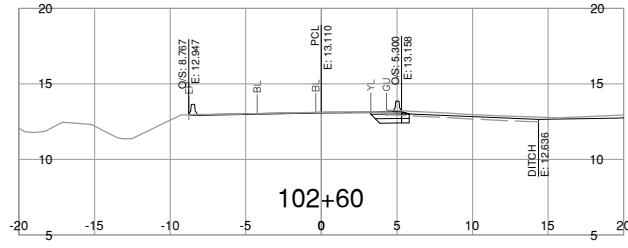
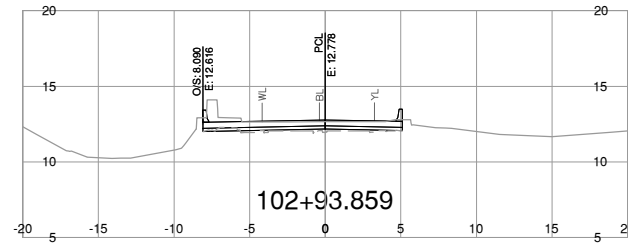
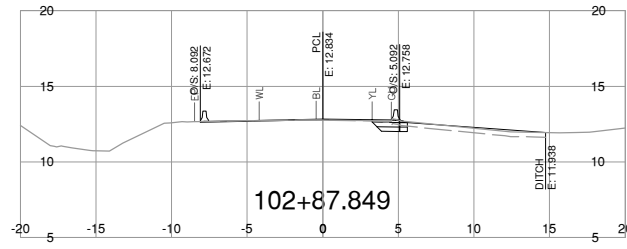
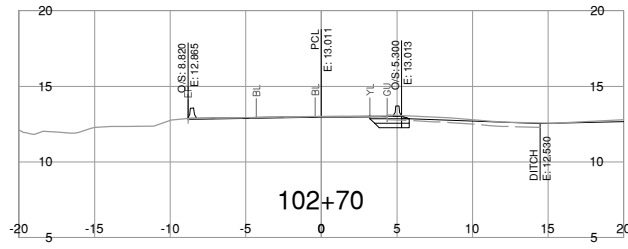

NOTE: STRIPPING REMOVAL APPLIES ONLY TO THE AREA BETWEEN SLOPE STAKE LINES (TOES & TOP OF CUT) OF PROPOSED ROADWAY TEMPLATE

FOR REFERENCE ONLY

DRAFT

BINNIE
The people behind your infrastructure.

R.F. BINNIE & ASSOCIATES LTD.
300 - 4940 Canada Way,
Burnaby, BC V5G 4K6
TEL 604 420 1721
BINNIE.com

MINISTRY OF TRANSPORTATION
AND INFRASTRUCTURE
SOUTH COAST REGION
HIGHWAY ENGINEERING AND GEOMATICS

L100-LINE CROSS SECTIONS
HIGHWAY No. 1
COLQUITZ BRIDGES RETROFIT AND BUS LANE EXTENSION

SCALE 0 2 1:250 12m

REV	DATE	REVISIONS	SIGNATURE

CAD FILENAME: SECT-L100-22-0393.DWG
DATE: 2023-09-28
FILE NUMBER: 22-0393

DESIGNED _____	M.C. DATE	OCT 2023
QUALITY CONTROL _____	M.C. DATE	OCT 2023
QUALITY ASSURANCE _____	M.C. DATE	OCT 2023
DRAWN _____	J.T. DATE	OCT 2023

PROJECT NUMBER	REG	DRAWING NUMBER	REV
17065-0001	1	R1-1060-L100XS-2	

Sep 28, 2023 09:43 AM P:\2022\22-0393\100 - CAD Files\00-ColquitzBridges\Drawing\Production\1000_DesignSections\SECT-L100_22-0393

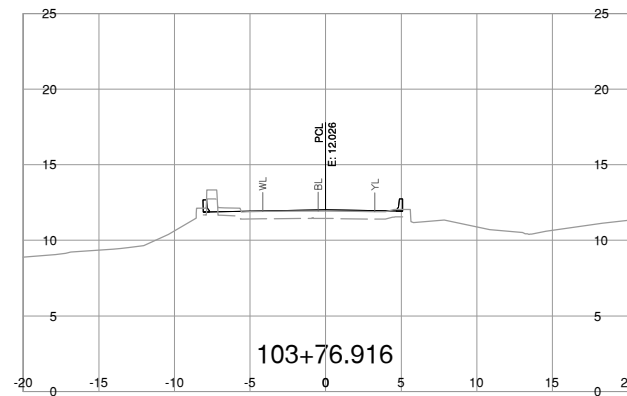
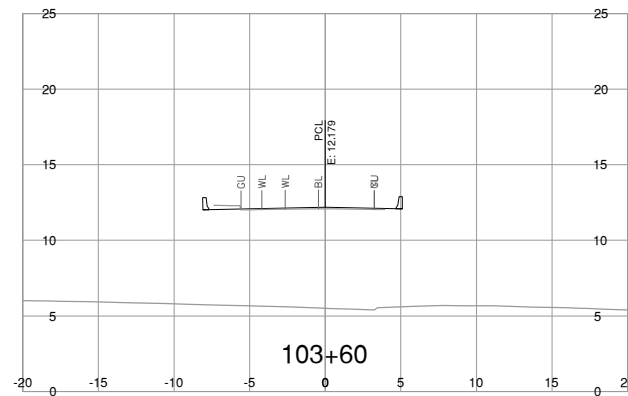
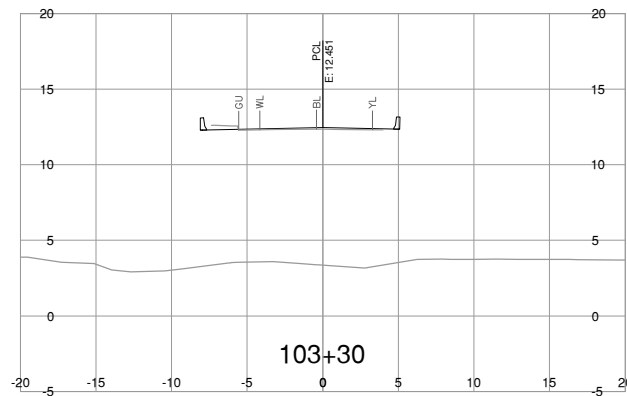
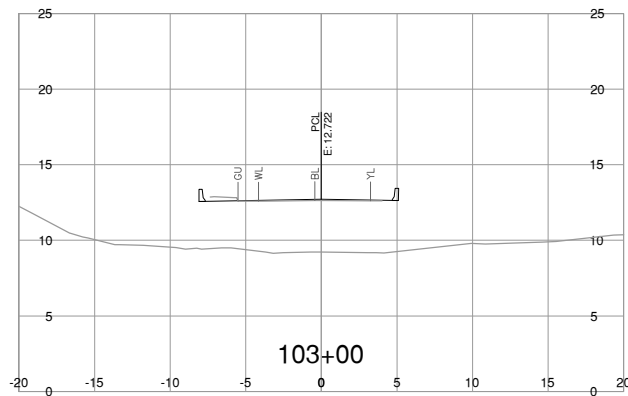
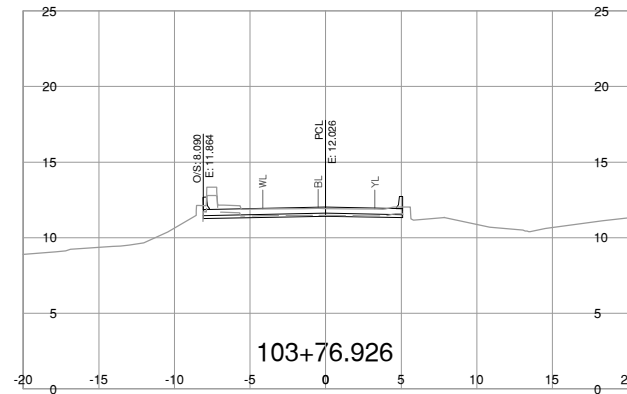
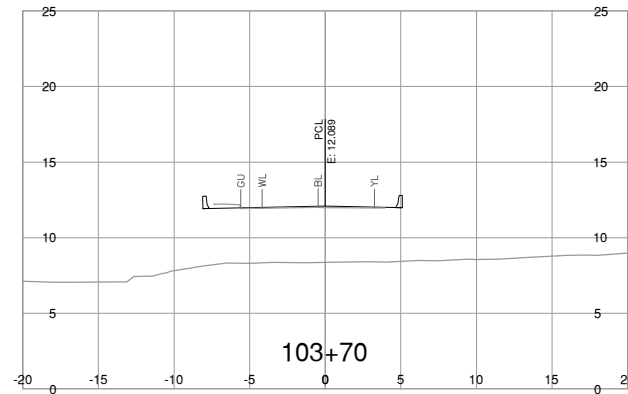
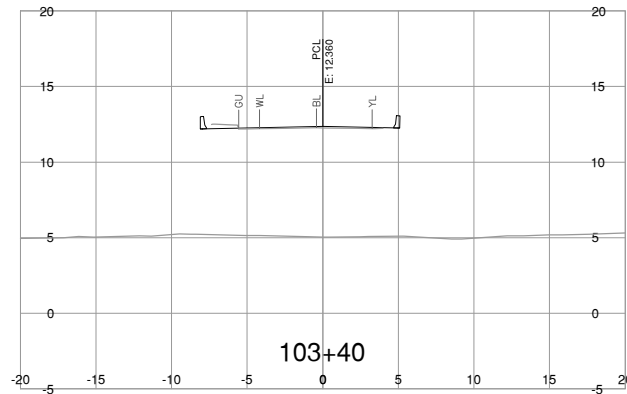
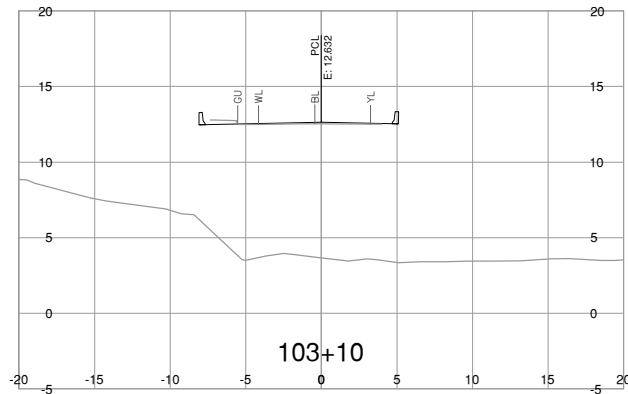
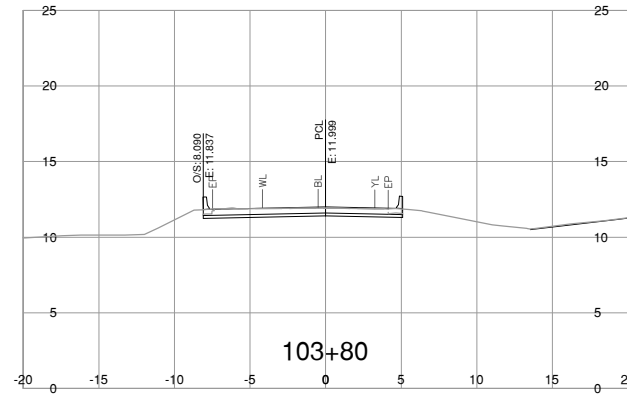
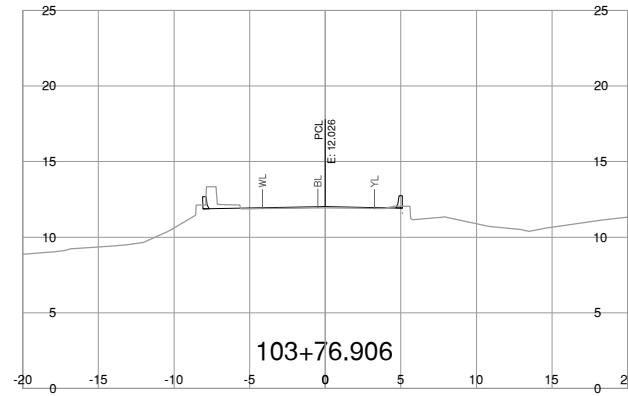
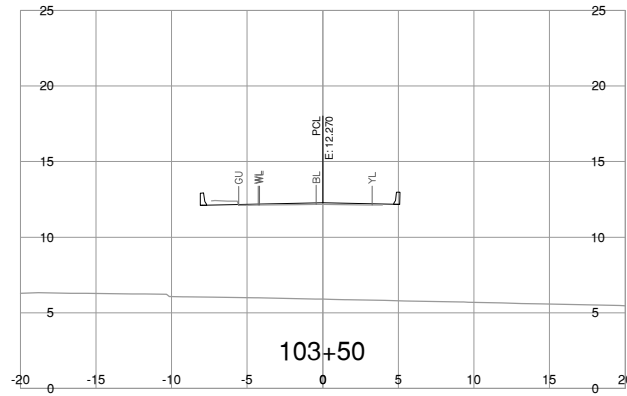
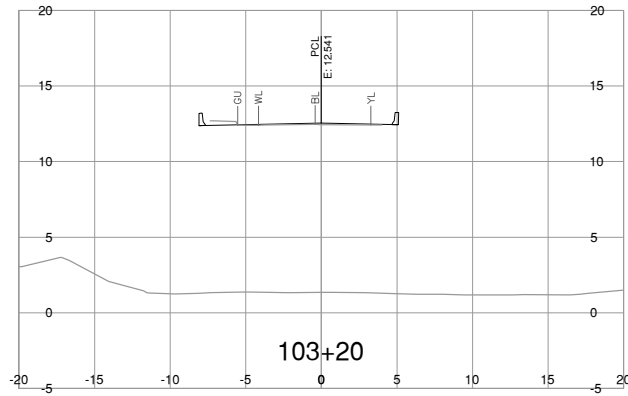

NOTE: STRIPPING REMOVAL APPLIES ONLY TO THE AREA BETWEEN SLOPE STAKE LINES (TOES & TOP OF CUT) OF PROPOSED ROADWAY TEMPLATE

FOR REFERENCE ONLY

DRAFT



BINNIE
The people behind your infrastructure.

R.F. BINNIE & ASSOCIATES LTD.
300 - 4940 Canada Way,
Burnaby, BC V5G 4K6
TEL 604 420 1721
BINNIE.com



BRITISH COLUMBIA
MINISTRY OF TRANSPORTATION AND INFRASTRUCTURE
SOUTH COAST REGION
HIGHWAY ENGINEERING AND GEOMATICS

L100-LINE CROSS SECTIONS
HIGHWAY No. 1
COLQUITZ BRIDGES RETROFIT AND BUS LANE EXTENSION

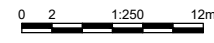
SCALE  CAD FILENAME SECT-L100-22-0393.DWG
DATE 2023-09-28
FILE NUMBER 22-0393

REV	DATE	REVISIONS	SIGNATURE

DESIGNED _____	M.C.	DATE <u>OCT 2023</u>
QUALITY CONTROL _____	M.C.	DATE <u>OCT 2023</u>
QUALITY ASSURANCE _____	M.C.	DATE <u>OCT 2023</u>
DRAWN _____	J.T.	DATE <u>OCT 2023</u>
PROJECT NUMBER <u>17065-0001</u>	REG <u>1</u>	DRAWING NUMBER <u>R1-1060-L100XS-3</u>

Sep 28, 2023 09:43 AM P:\2022\22-0393\100 - CAD Files\00-ColquitzBridges\Drawing\Production\1000_DesignSections\SECT L100_22-0393

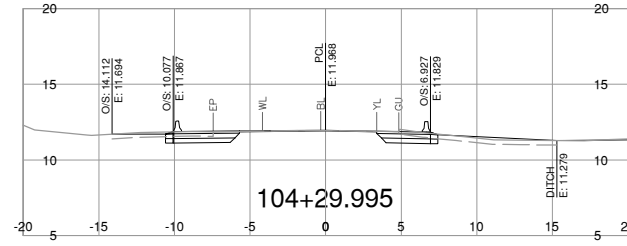
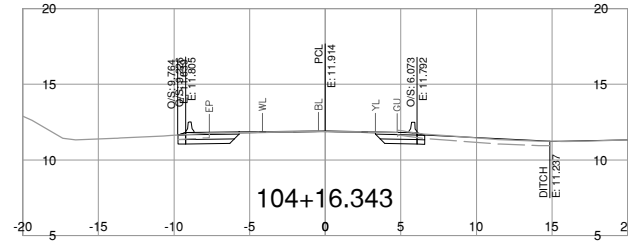
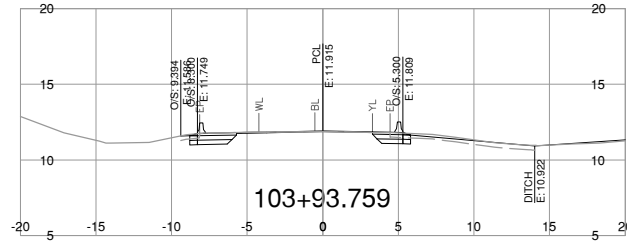
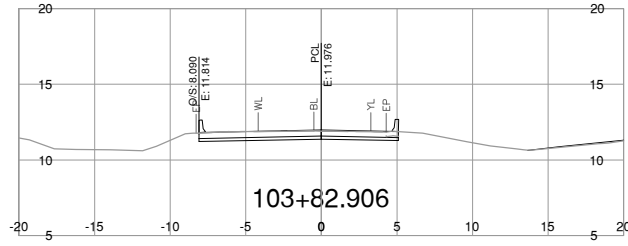
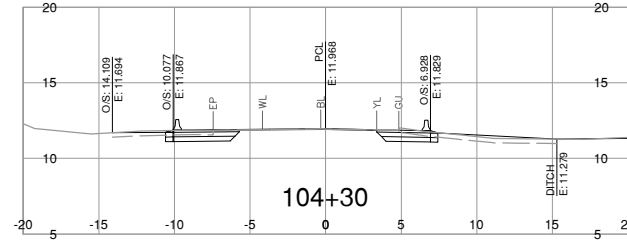
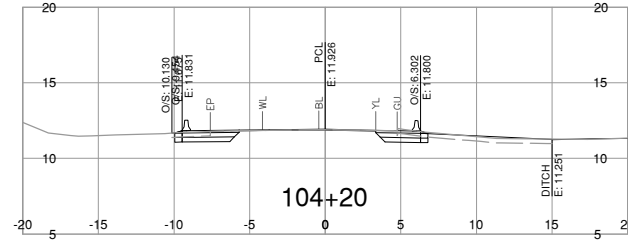
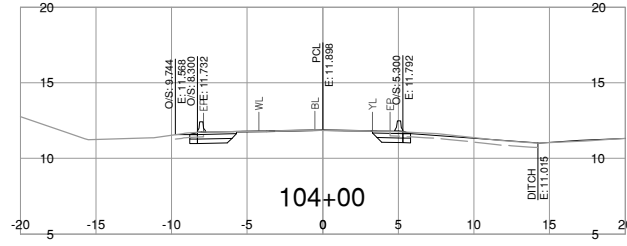
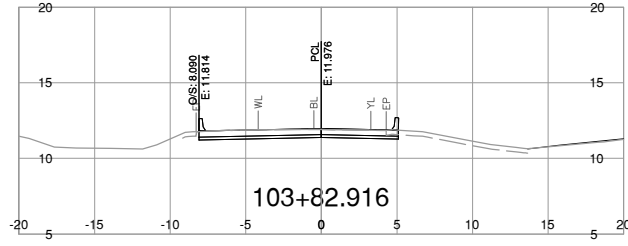
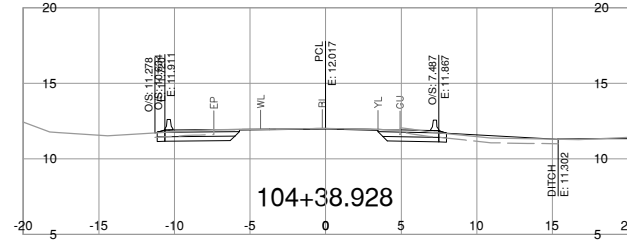
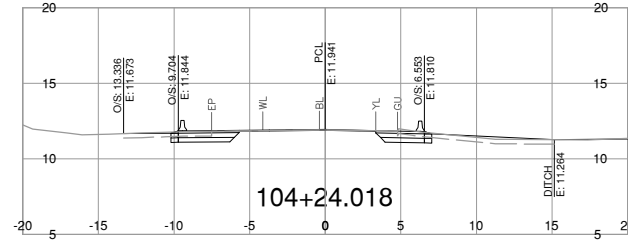
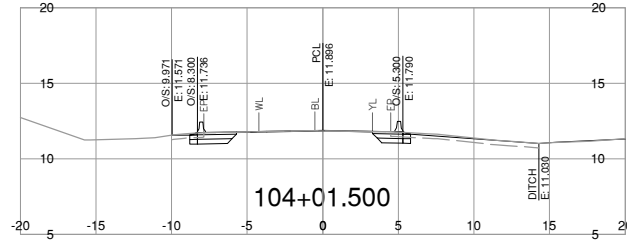
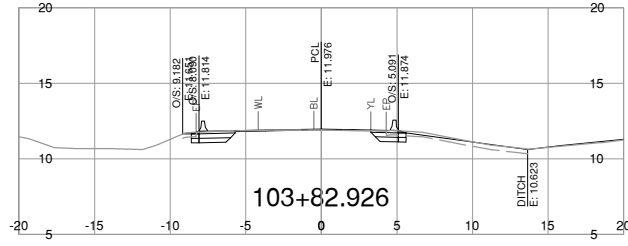
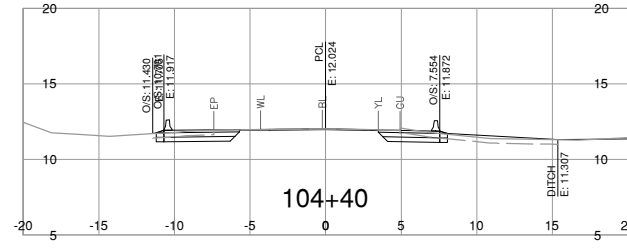
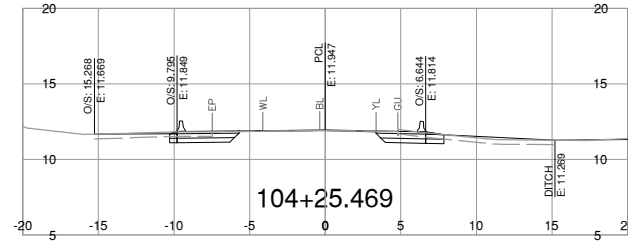
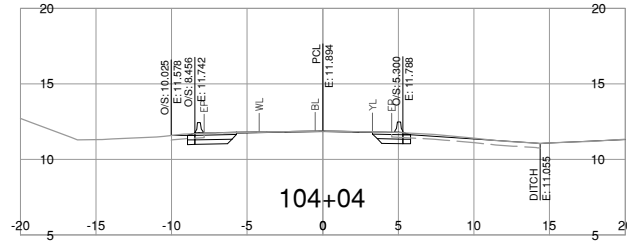
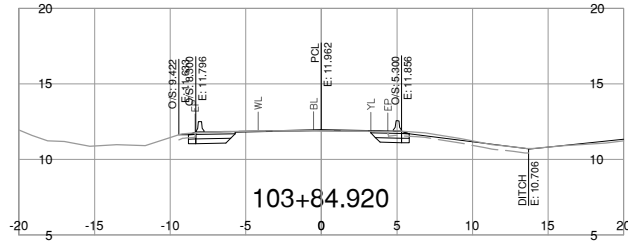
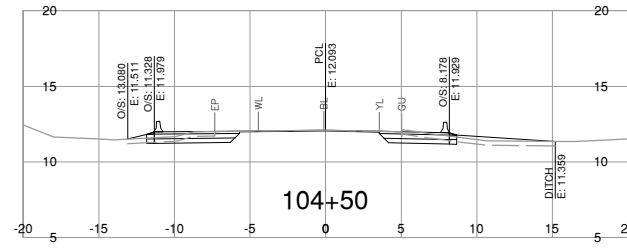
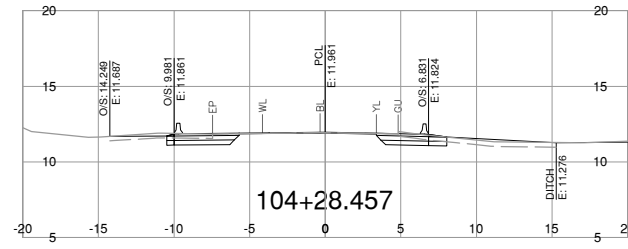
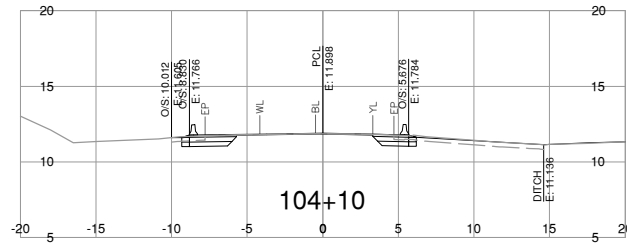
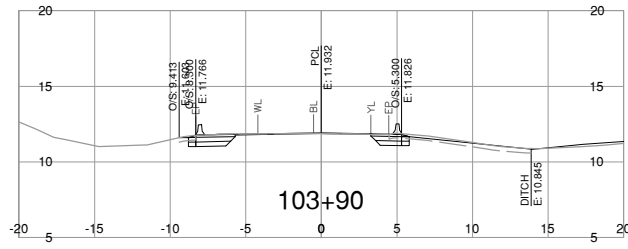

NOTE: STRIPPING REMOVAL APPLIES ONLY TO THE AREA BETWEEN SLOPE STAKE LINES (TOES & TOP OF CUT) OF PROPOSED ROADWAY TEMPLATE

FOR REFERENCE ONLY

DRAFT

R.F. BINNIE & ASSOCIATES LTD.
300 - 4940 Canada Way,
Burnaby, BC V5G 4K6
TEL 604 420 1721
BINNIE.com

BRITISH COLUMBIA
MINISTRY OF TRANSPORTATION AND INFRASTRUCTURE
SOUTH COAST REGION
HIGHWAY ENGINEERING AND GEOMATICS

L100-LINE CROSS SECTIONS
HIGHWAY No. 1
COLQUITZ BRIDGES RETROFIT AND BUS LANE EXTENSION

SCALE: 0 2 1:250 12m CAD FILENAME: SECT-L100-22-0393.DWG DATE: 2023-09-28 FILE NUMBER: 22-0393

REV	DATE	REVISIONS	SIGNATURE

DESIGNED	M.C.	DATE	OCT 2023
QUALITY CONTROL	M.C.	DATE	OCT 2023
QUALITY ASSURANCE	M.C.	DATE	OCT 2023
DRAWN	J.T.	DATE	OCT 2023

PROJECT NUMBER	REG	DRAWING NUMBER	REV
17065-0001	1	R1-1060-L100XS-4	

Sep 28, 2023 09:43 AM P:\2022\22-0393\100 - CAD Files\00-Cad\22\22-0393\100 - Design\Sections\SECT L100_22-0393

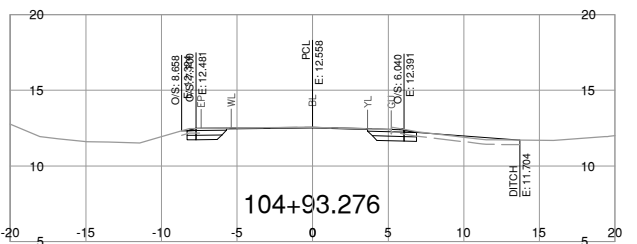
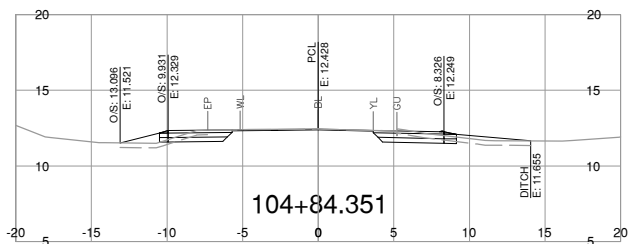
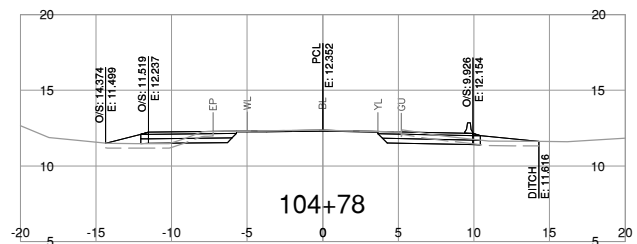
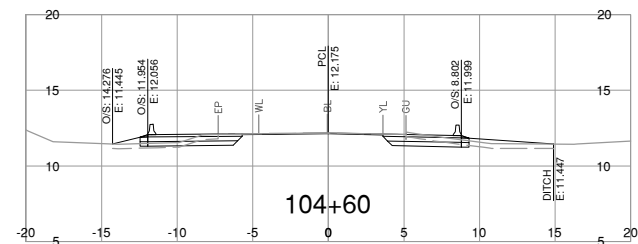
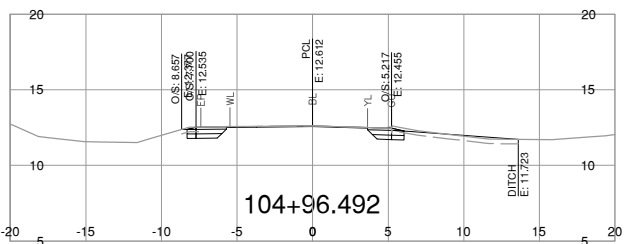
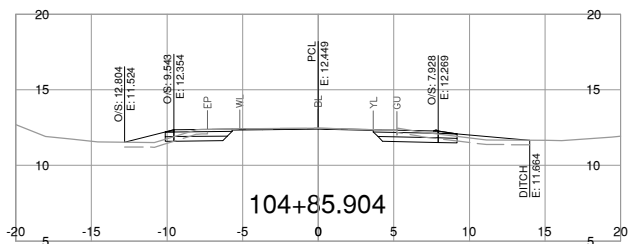
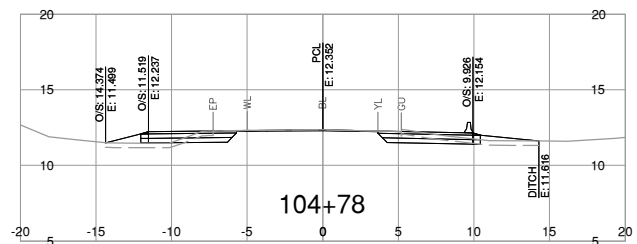
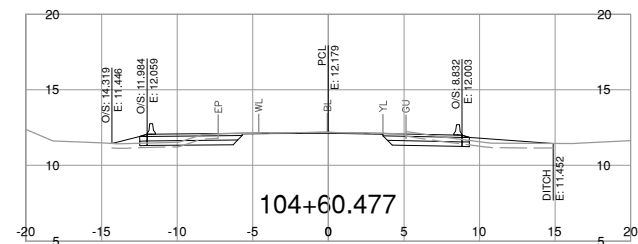
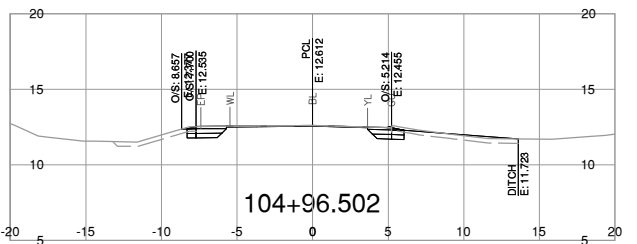
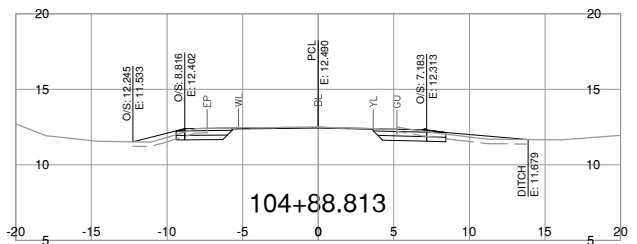
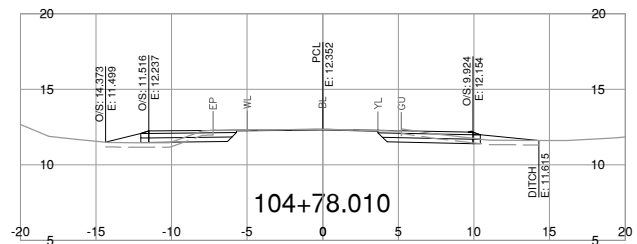
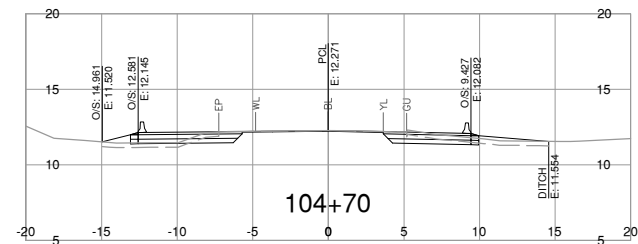
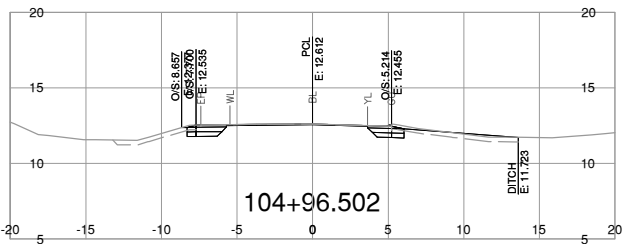
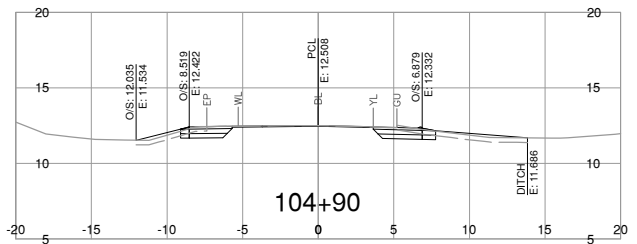
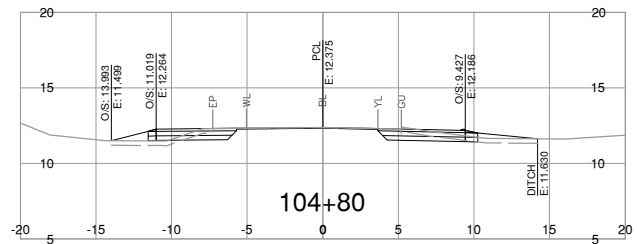
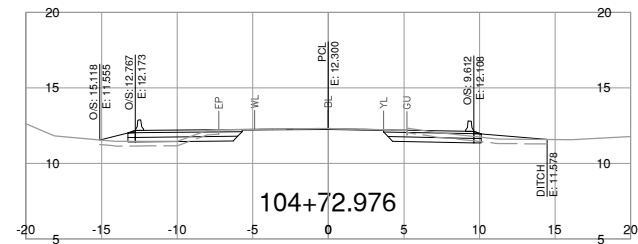
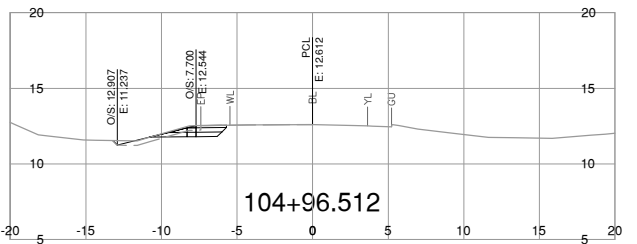
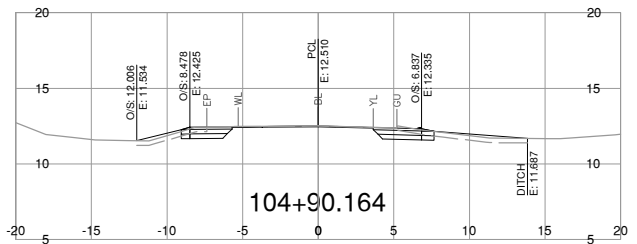
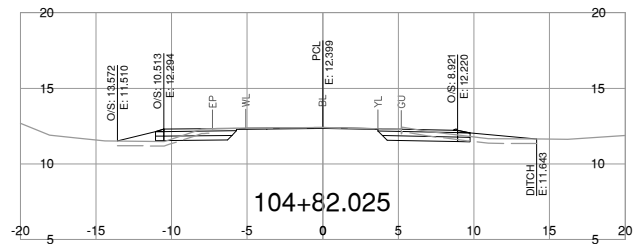
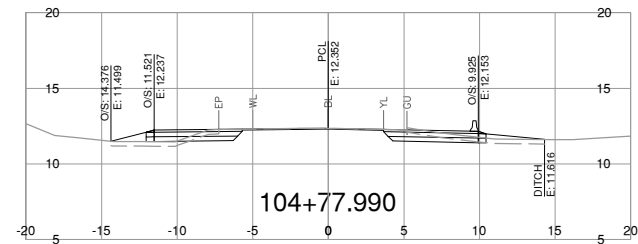

NOTE: STRIPPING REMOVAL APPLIES ONLY TO THE AREA BETWEEN SLOPE STAKE LINES (TOES & TOP OF CUT) OF PROPOSED ROADWAY TEMPLATE

FOR REFERENCE ONLY

DRAFT

BINNIE
The people behind your infrastructure.

R.F. BINNIE & ASSOCIATES LTD.
300 - 4940 Canada Way,
Burnaby, BC V5G 4K6
TEL 604 420 1721
BINNIE.com

SCALE: 0 2 1:250 12m

CAD FILENAME: SECT-L100_22-0393.DWG
DATE: 2023-09-28
FILE NUMBER: 22-0393

REV	DATE	REVISIONS	SIGNATURE

BRITISH COLUMBIA

MINISTRY OF TRANSPORTATION AND INFRASTRUCTURE
SOUTH COAST REGION
HIGHWAY ENGINEERING AND GEOMATICS

L100-LINE CROSS SECTIONS
HIGHWAY No. 1
COLQUITZ BRIDGES RETROFIT AND BUS LANE EXTENSION

DESIGNED	_____	M.C.	DATE	OCT 2023
QUALITY CONTROL	_____	M.C.	DATE	OCT 2023
QUALITY ASSURANCE	_____	M.C.	DATE	OCT 2023
DRAWN	_____	J.T.	DATE	OCT 2023
PROJECT NUMBER	17065-0001	REG	1	DRAWING NUMBER
				R1-1060-L100XS-5

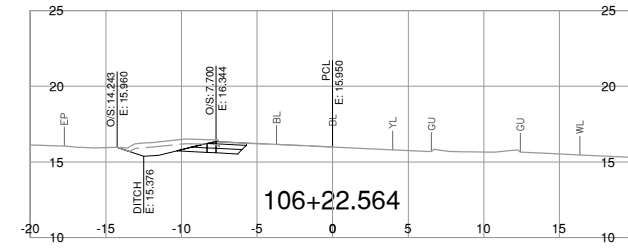
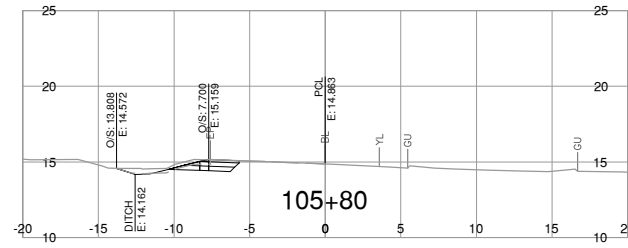
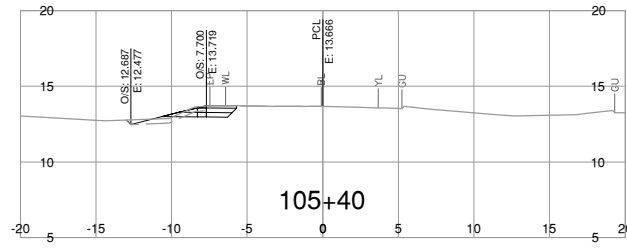
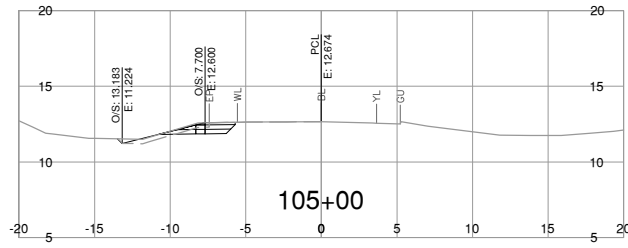
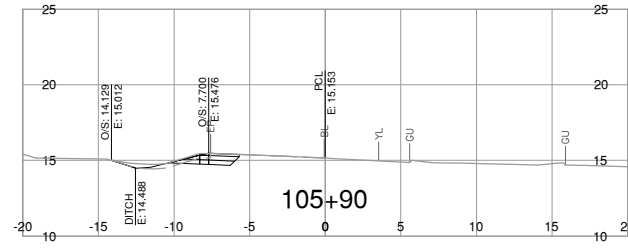
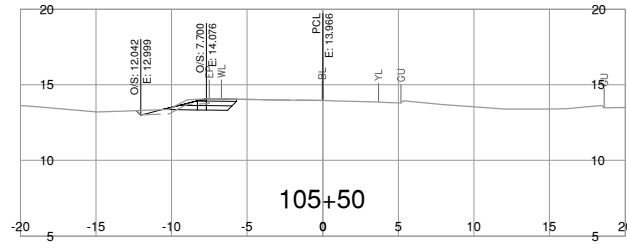
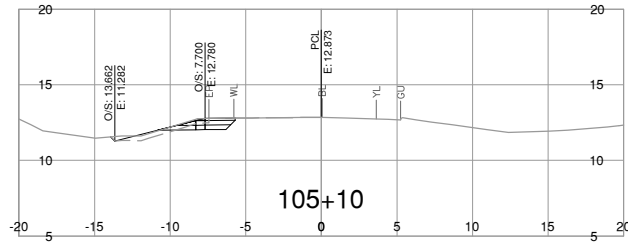
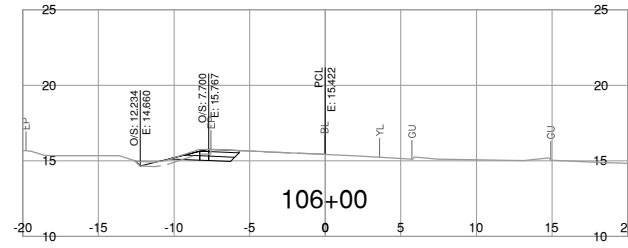
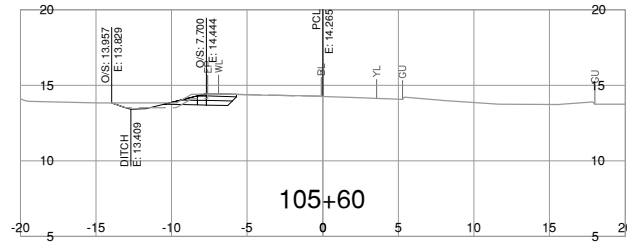
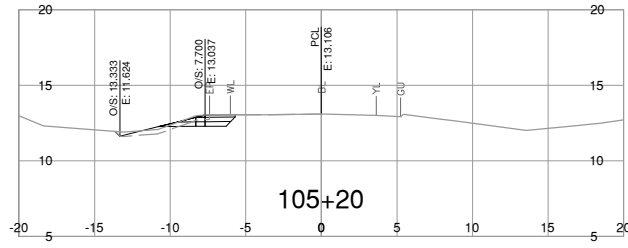
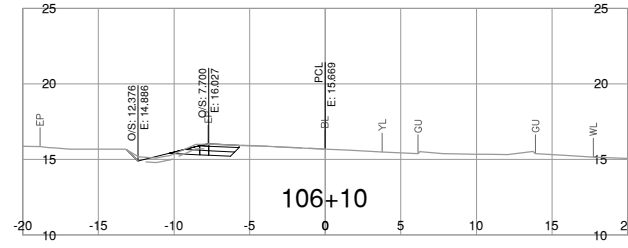
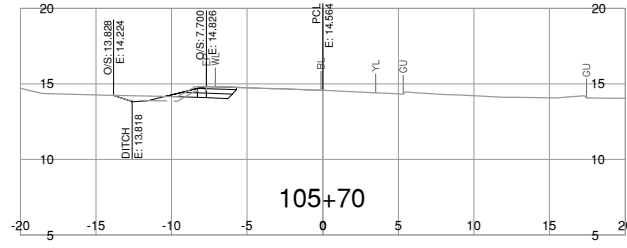
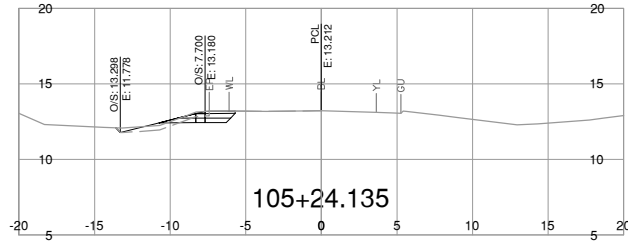
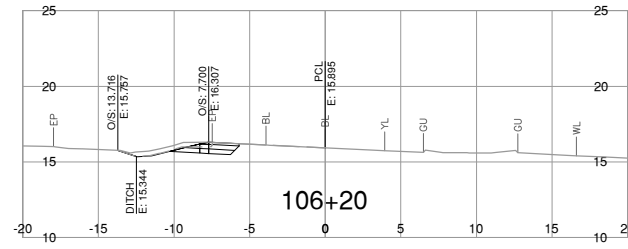
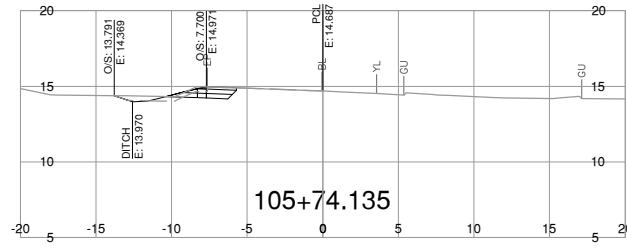
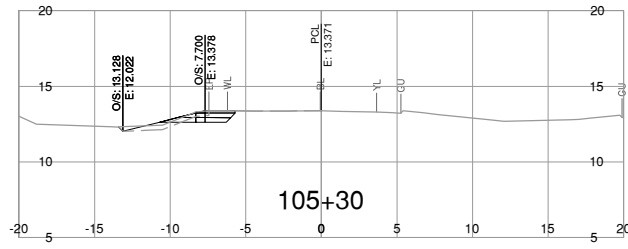

NOTE: STRIPPING REMOVAL APPLIES ONLY TO THE AREA BETWEEN SLOPE STAKE LINES (TOES & TOP OF CUT) OF PROPOSED ROADWAY TEMPLATE

FOR REFERENCE ONLY

DRAFT

BINNIE
The people behind your infrastructure.

R.F. BINNIE & ASSOCIATES LTD.
300 - 4940 Canada Way,
Burnaby, BC V5G 4K6
TEL 604 420 1721
BINNIE.com

BRITISH COLUMBIA

MINISTRY OF TRANSPORTATION AND INFRASTRUCTURE
SOUTH COAST REGION
HIGHWAY ENGINEERING AND GEOMATICS

SCALE 0 2 1:250 12m

CAD FILENAME SECT-L100-22-0393.DWG
DATE 2023-09-28
FILE NUMBER 22-0393

REV	DATE	REVISIONS	SIGNATURE

L100-LINE CROSS SECTIONS
HIGHWAY No. 1
COLQUITZ BRIDGES RETROFIT AND BUS LANE EXTENSION

DESIGNED	_____	M.C.	DATE	OCT 2023	
QUALITY CONTROL	_____	M.C.	DATE	OCT 2023	
QUALITY ASSURANCE	_____	M.C.	DATE	OCT 2023	
DRAWN	_____	J.T.	DATE	OCT 2023	
PROJECT NUMBER	17065-0001	REG	1	DRAWING NUMBER	R1-1060-L100XS-6

Oct 11, 2023 - 01:21 PM P:\2022\22-038300 - CAD Files\00-Design\Bridges\Drawings\Production\1000_Design\Sections\SECT_L200_22-0383

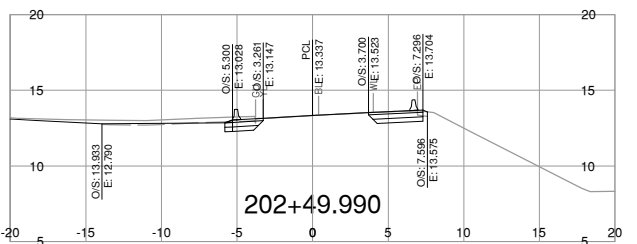
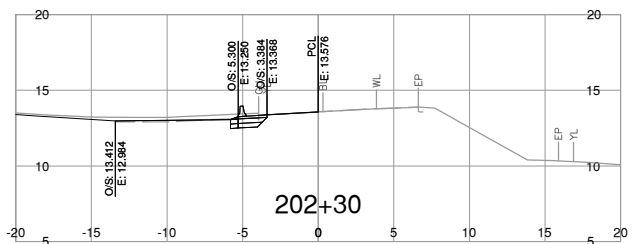
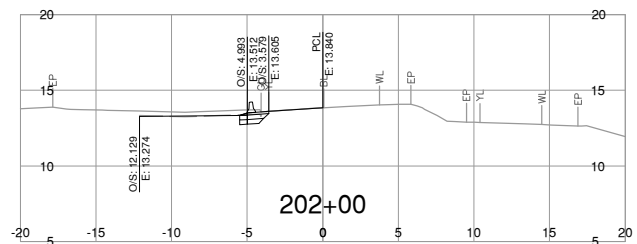
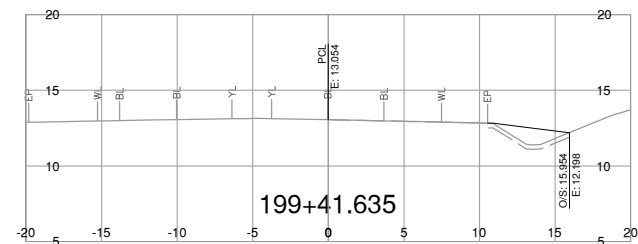
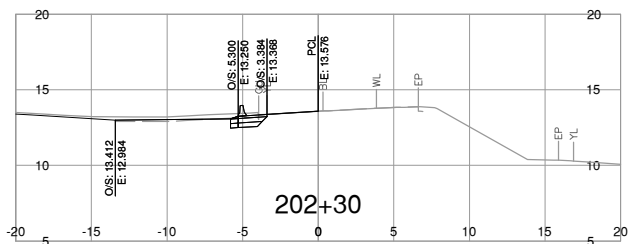
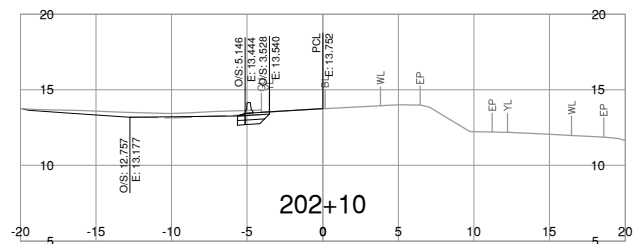
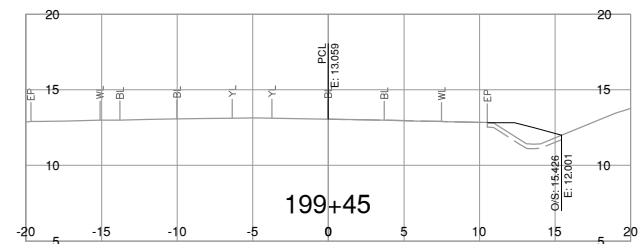
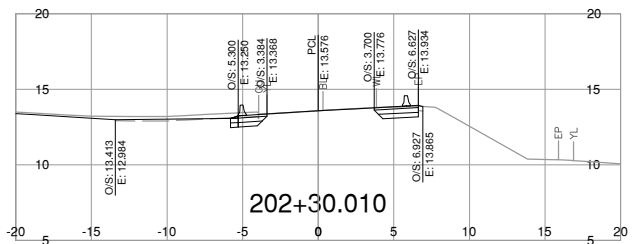
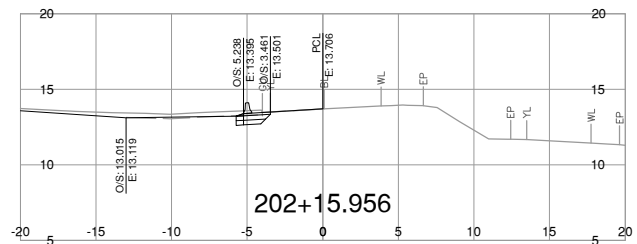
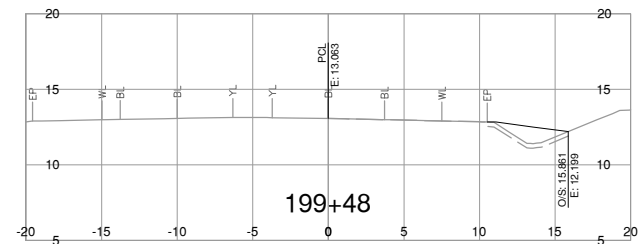
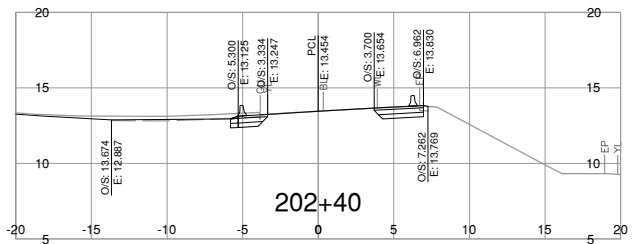
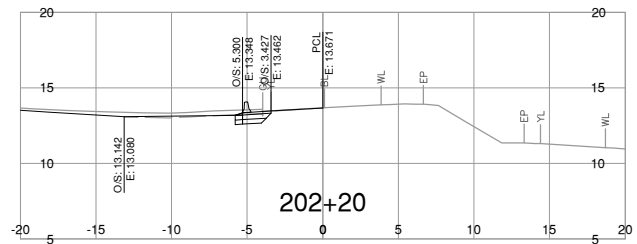
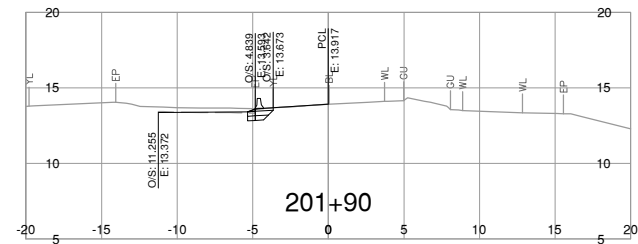
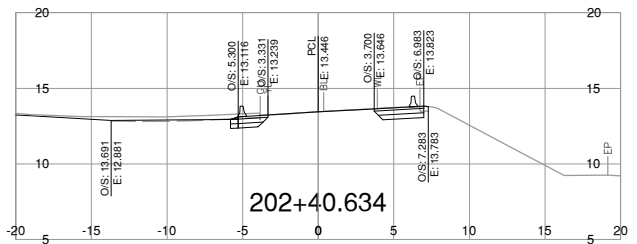
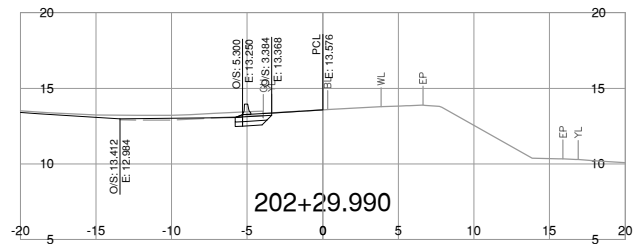
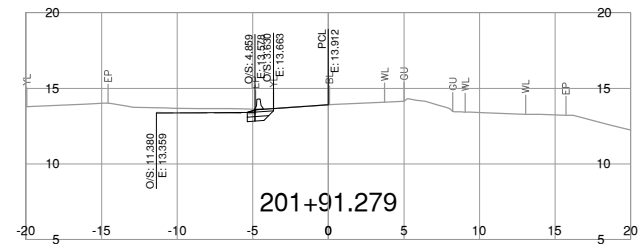

NOTE: STRIPPING REMOVAL APPLIES ONLY TO THE AREA BETWEEN SLOPE STAKE LINES (TOES & TOP OF CUT) OF PROPOSED ROADWAY TEMPLATE

FOR REFERENCE ONLY

DRAFT

		R.F. BINNIE & ASSOCIATES LTD. 300 - 4940 Canada Way, Burnaby, BC V5G 4K6 TEL 604 420 1721 BINNIE.com				MINISTRY OF TRANSPORTATION AND INFRASTRUCTURE SOUTH COAST REGION HIGHWAY ENGINEERING AND GEOMATICS	
SCALE 0 2 1:250 12m		CAD FILENAME SECT-L200_22-0383.DWG		DATE 2023-10-11		L200-LINE CROSS SECTIONS HIGHWAY No. 1 COLQUITZ BRIDGES RETROFIT AND BUS LANE EXTENSION	
FILE NUMBER 22-0383		REVISIONS		SIGNATURE		DESIGNED _____ M.C. DATE OCT 2023 QUALITY CONTROL _____ M.C. DATE OCT 2023 QUALITY ASSURANCE _____ M.C. DATE OCT 2023 DRAWN _____ J.T. DATE OCT 2023	
PROJECT NUMBER 17065-0001		REG 1		DRAWING NUMBER R1-1060-L200XS-1		REV _____	

04.11.2023 01:21 PM P:\2022\22-038300 - CAD Files\00-Design\Drawings\Production\1000 - Design\sections\SECT_L200_22-0383

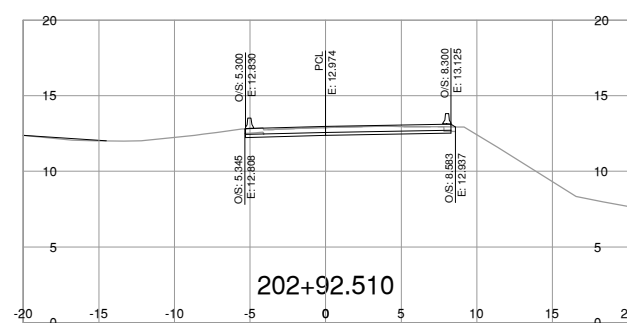
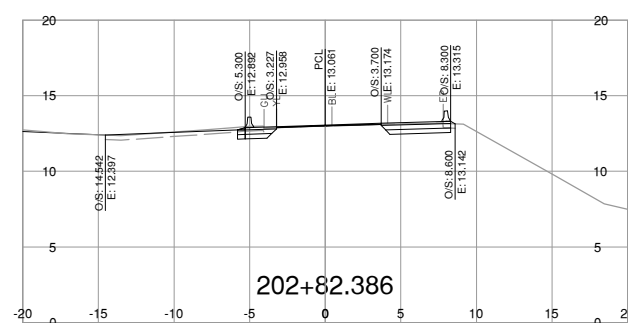
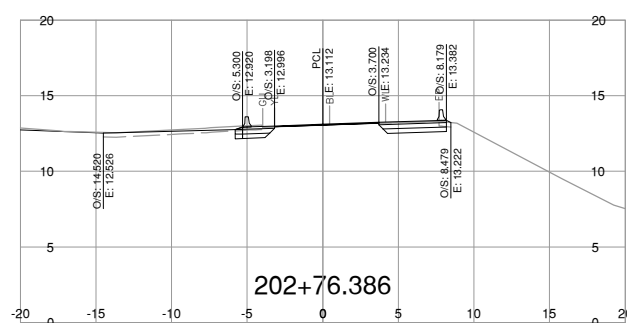
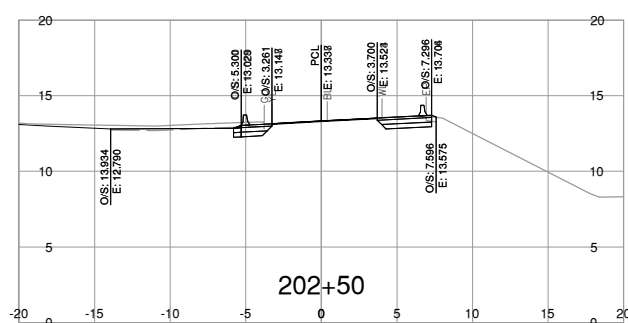
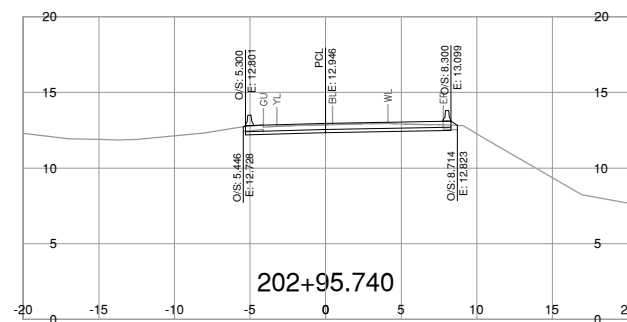
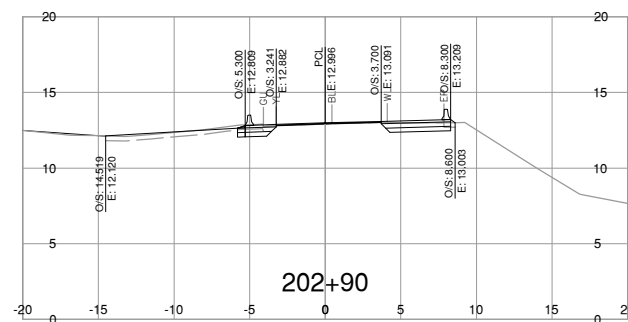
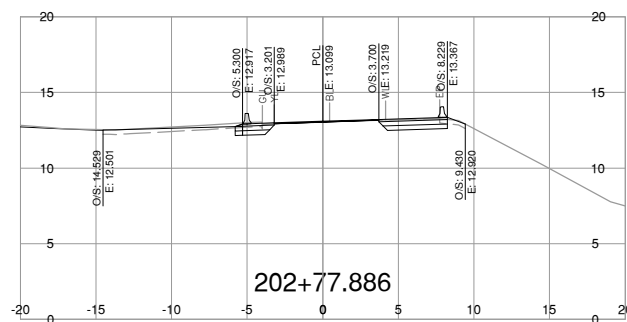
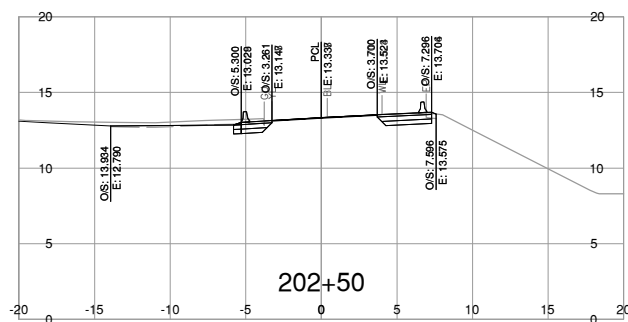
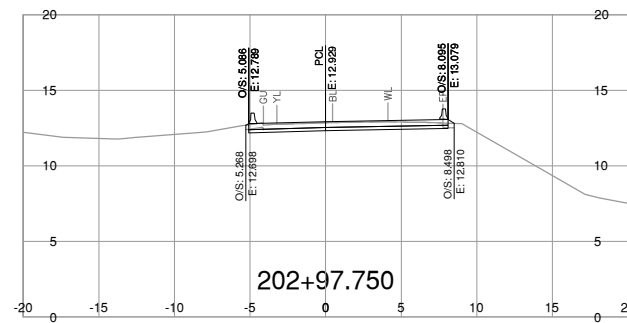
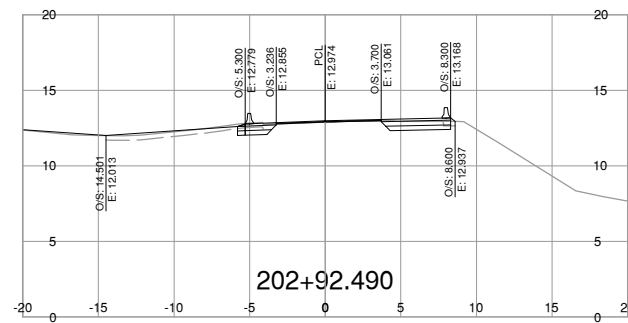
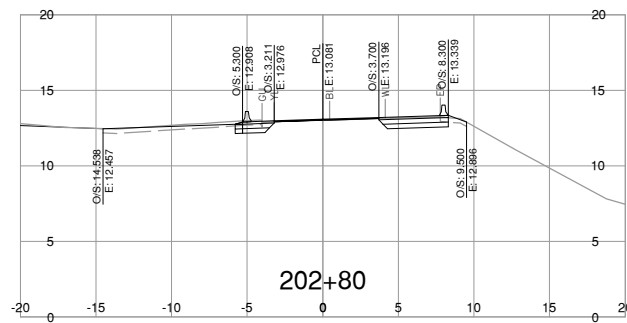
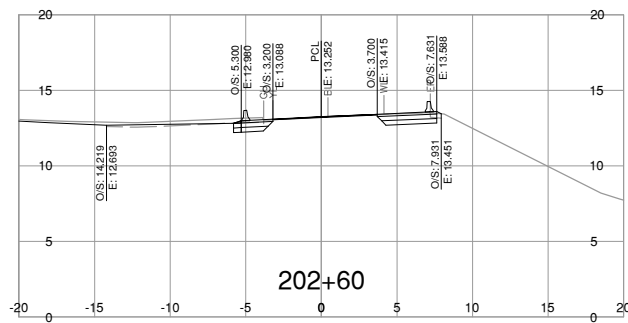
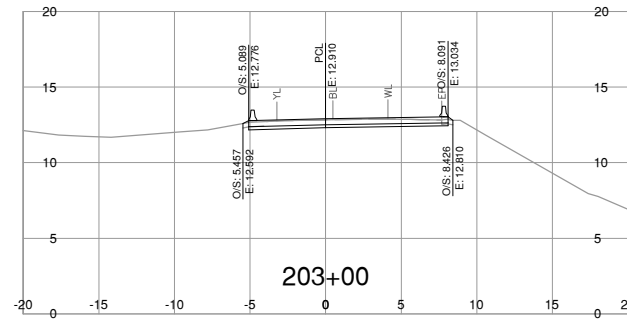
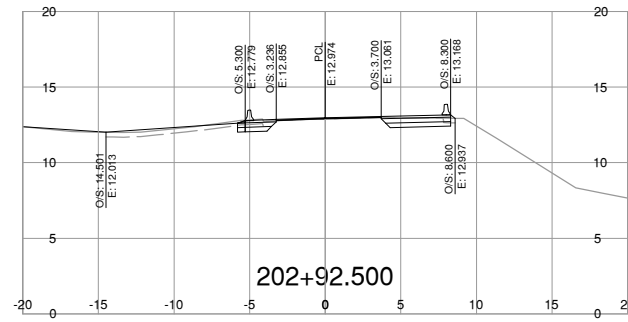
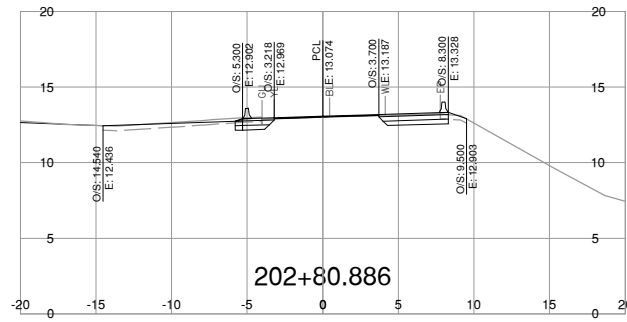
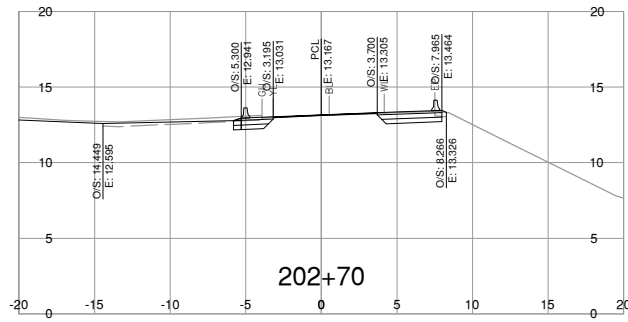

NOTE: STRIPPING REMOVAL APPLIES ONLY TO THE AREA BETWEEN SLOPE STAKE LINES (TOES & TOP OF CUT) OF PROPOSED ROADWAY TEMPLATE

FOR REFERENCE ONLY

DRAFT

<p>BINNIE The people behind your infrastructure.</p>		<p>R.F. BINNIE & ASSOCIATES LTD. 300 - 4940 Canada Way, Burnaby, BC V5G 4K6 TEL 604 420 1721 BINNIE.com</p>		<p>BRITISH COLUMBIA</p>		<p>MINISTRY OF TRANSPORTATION AND INFRASTRUCTURE SOUTH COAST REGION HIGHWAY ENGINEERING AND GEOMATICS</p>	
<p>SCALE 0 2 1:250 12m</p>		<p>CAD FILENAME SECT-L200_22-0383.DWG</p>		<p>DATE 2023-10-11</p>		<p>FILE NUMBER 22-0383</p>	
<p>REV</p>		<p>DATE</p>		<p>REVISIONS</p>		<p>SIGNATURE</p>	
<p>DESIGNED</p>		<p>M.C.</p>		<p>DATE</p>		<p>OCT 2023</p>	
<p>QUALITY CONTROL</p>		<p>M.C.</p>		<p>DATE</p>		<p>OCT 2023</p>	
<p>QUALITY ASSURANCE</p>		<p>M.C.</p>		<p>DATE</p>		<p>OCT 2023</p>	
<p>DRAWN</p>		<p>J.T.</p>		<p>DATE</p>		<p>OCT 2023</p>	
<p>PROJECT NUMBER</p>		<p>REG</p>		<p>DRAWING NUMBER</p>		<p>REV</p>	
<p>17065-0001</p>		<p>1</p>		<p>R1-1060-L200XS-2</p>		<p></p>	

L200-LINE CROSS SECTIONS
HIGHWAY No. 1
COLQUITZ BRIDGES RETROFIT AND BUS LANE EXTENSION

04.11.2023 01:21 PM P:\2022\22-0383\00 - CAD Files\00-Design\Sections\Drawing\production\1000_Design\Sections\SECT_L200_22-0383

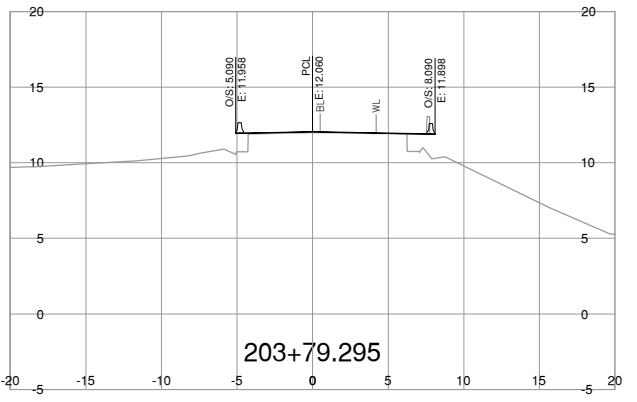
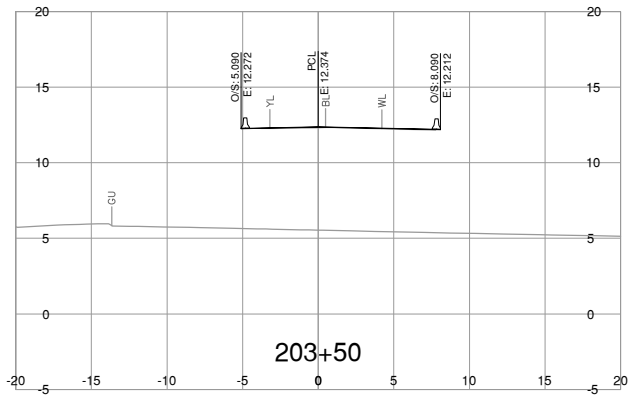
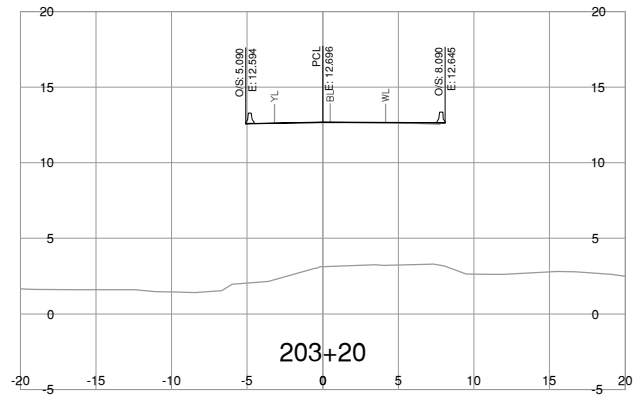
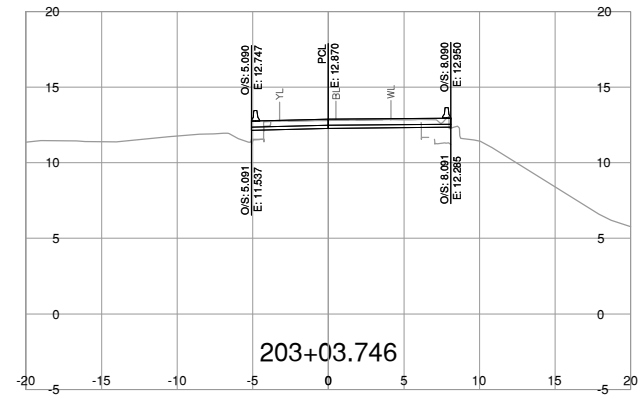
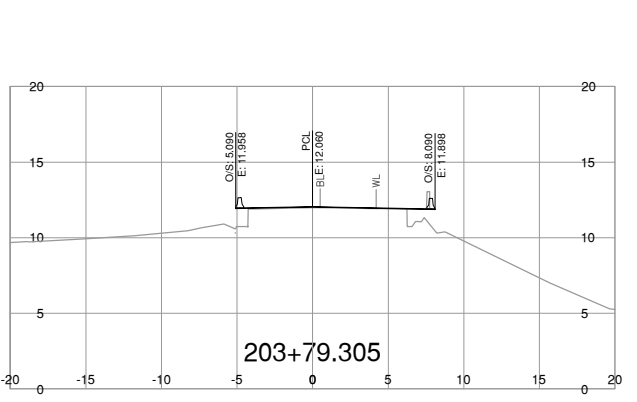
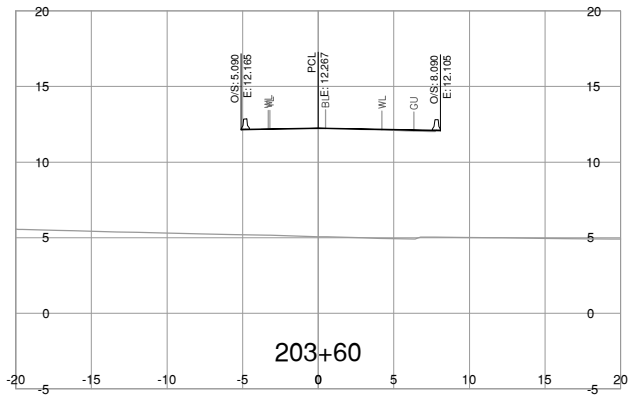
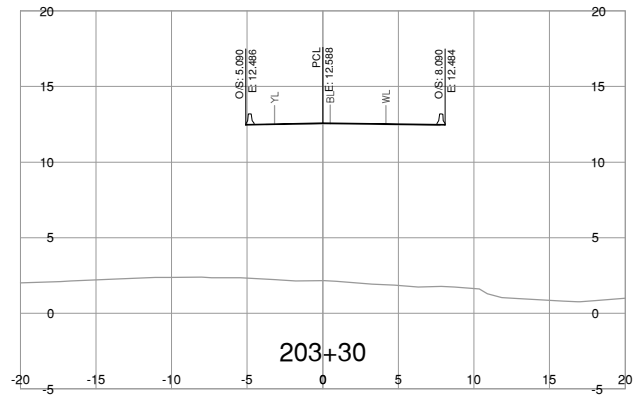
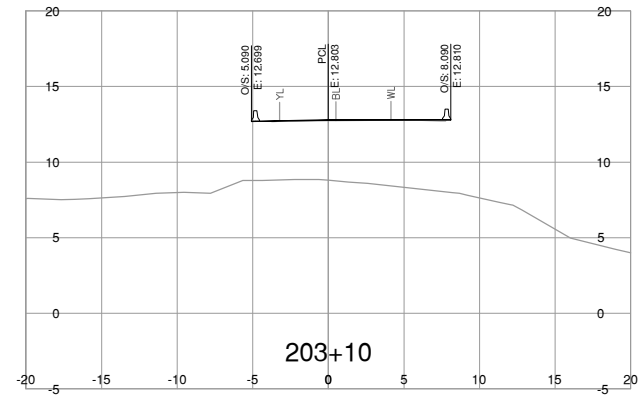
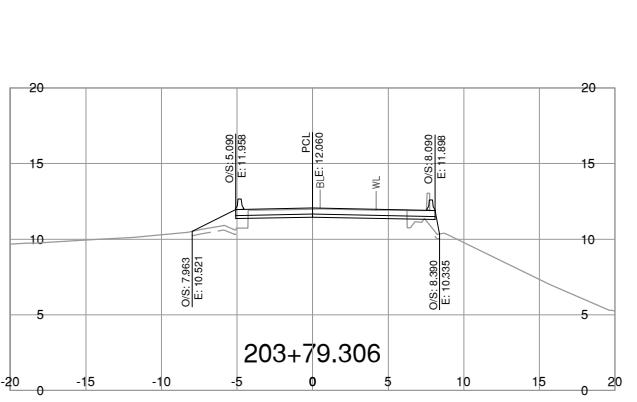
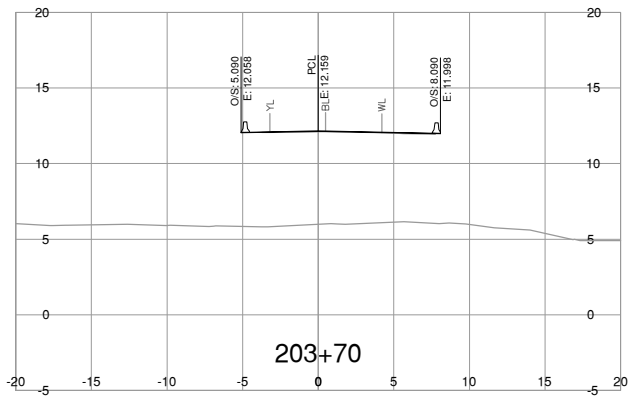
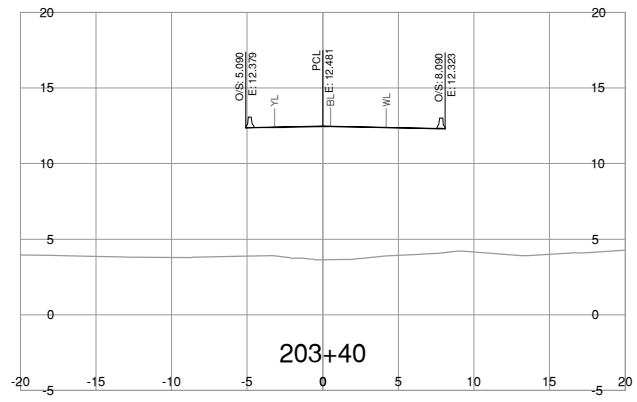
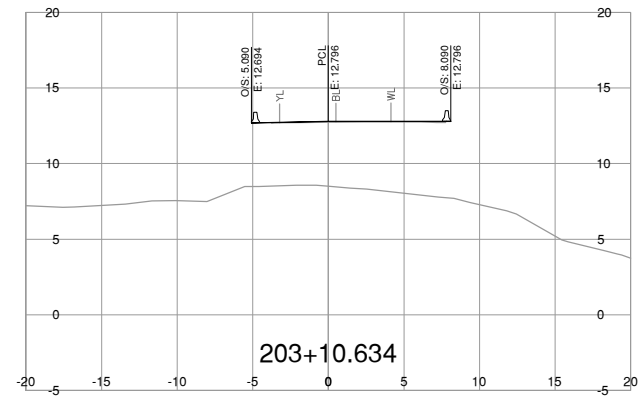

NOTE: STRIPPING REMOVAL APPLIES ONLY TO THE AREA BETWEEN SLOPE STAKE LINES (TOES & TOP OF CUT) OF PROPOSED ROADWAY TEMPLATE

FOR REFERENCE ONLY

DRAFT

<p>BINNIE The people behind your infrastructure.</p>		<p>R.F. BINNIE & ASSOCIATES LTD. 300 - 4940 Canada Way, Burnaby, BC V5G 4K6 TEL 604 420 1721 BINNIE.com</p>		<p>BRITISH COLUMBIA</p>		<p>MINISTRY OF TRANSPORTATION AND INFRASTRUCTURE SOUTH COAST REGION HIGHWAY ENGINEERING AND GEOMATICS</p>	
<p>SCALE </p>		<p>CAD FILENAME SECT-L200_22-0383.DWG</p>		<p>DATE 2023-10-11</p>		<p>FILE NUMBER 22-0383</p>	
<p>REV</p>		<p>DATE</p>		<p>REVISIONS</p>		<p>SIGNATURE</p>	
<p>DESIGNED _____ M.C. DATE OCT 2023</p>		<p>QUALITY CONTROL _____ M.C. DATE OCT 2023</p>		<p>QUALITY ASSURANCE _____ M.C. DATE OCT 2023</p>		<p>DRAWN _____ J.T. DATE OCT 2023</p>	
<p>PROJECT NUMBER 17065-0001</p>		<p>REG 1</p>		<p>DRAWING NUMBER R1-1060-L200XS-3</p>		<p>REV</p>	

L200-LINE CROSS SECTIONS
HIGHWAY No. 1
COLQUITZ BRIDGES RETROFIT AND BUS LANE EXTENSION

04_11_2023 01:21 PM P:\2022\22-038300 - CAD Files\00-Design\Drawings\Production\1000_Design\Sections\SECT-L200_22-0383

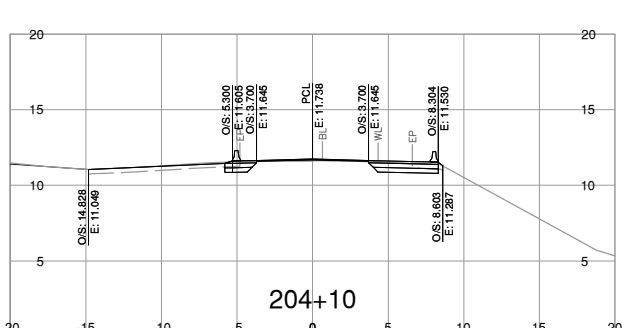
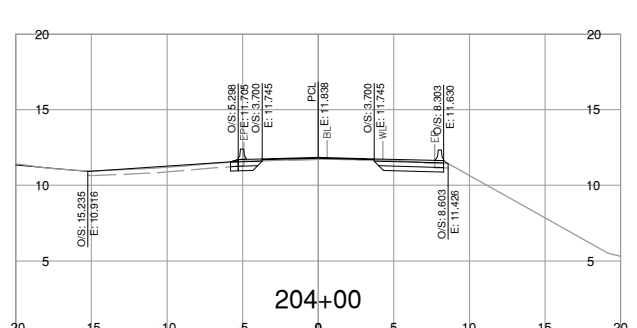
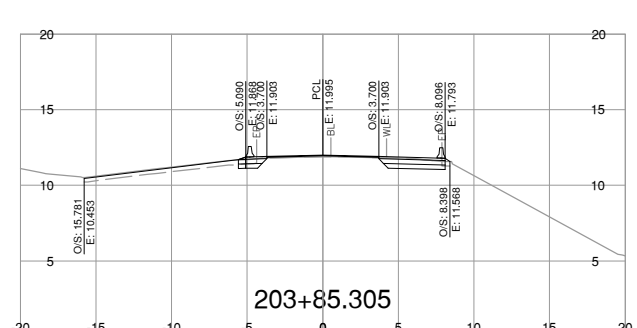
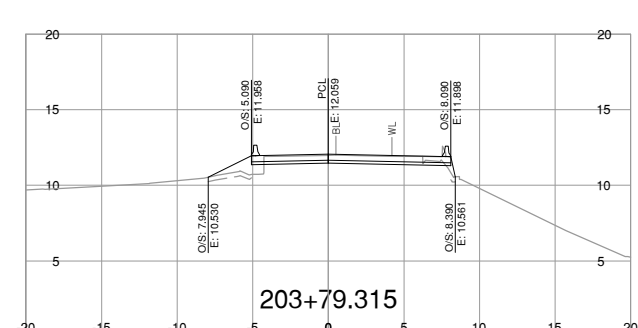
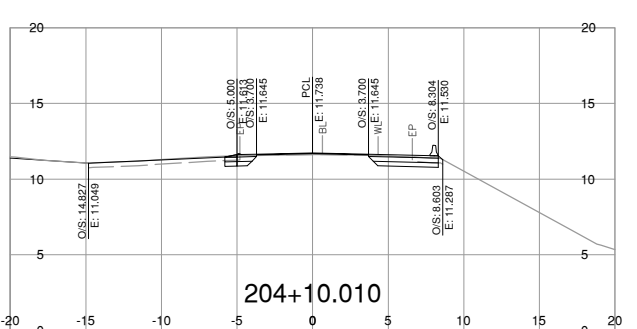
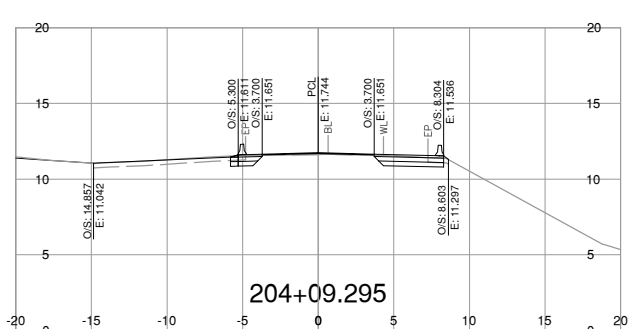
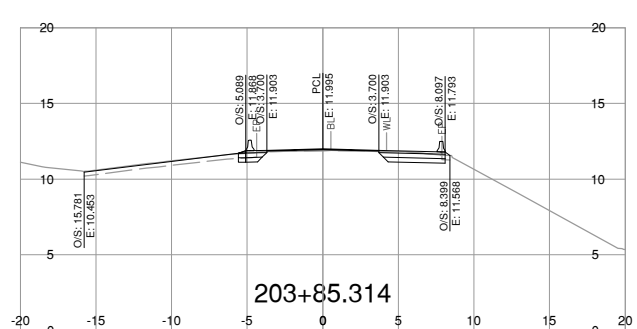
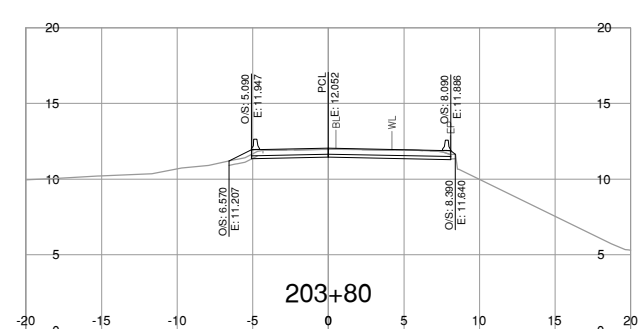
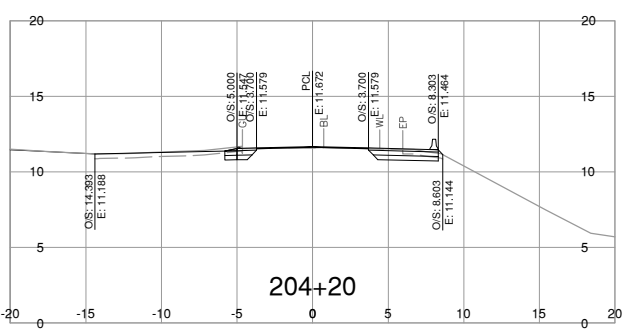
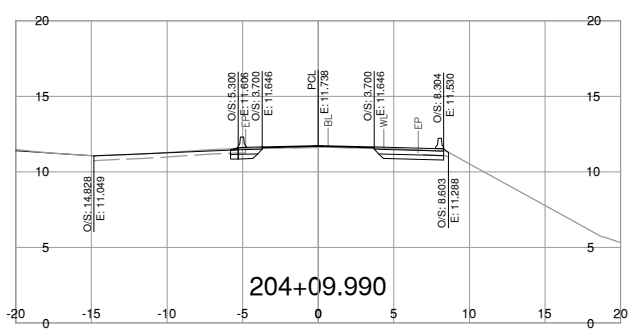
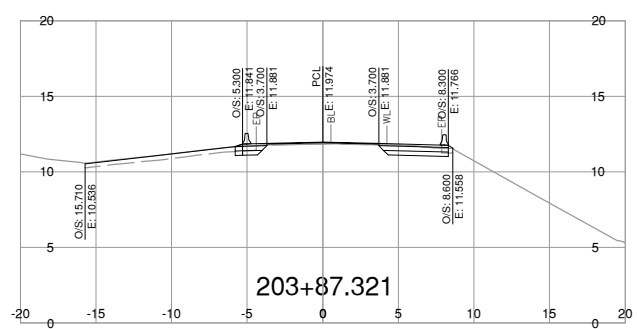
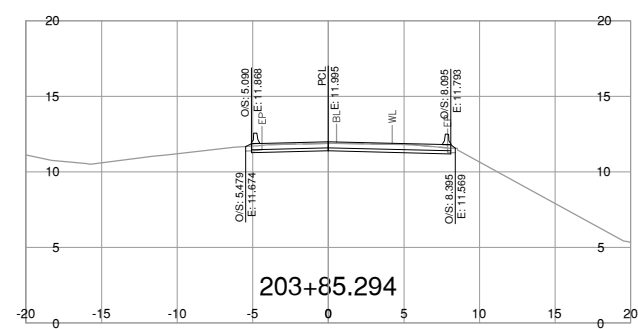
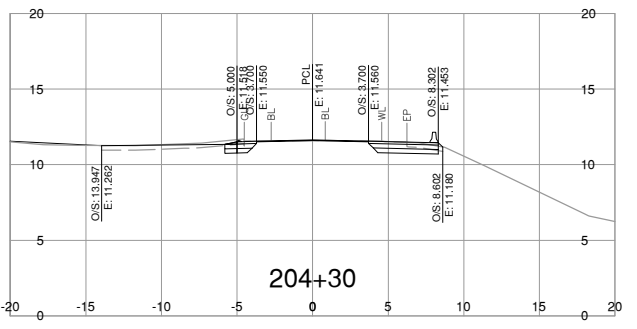
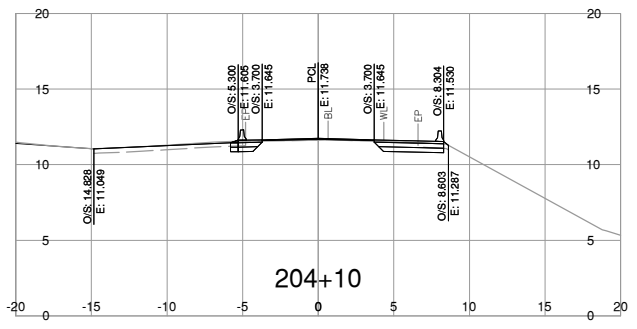
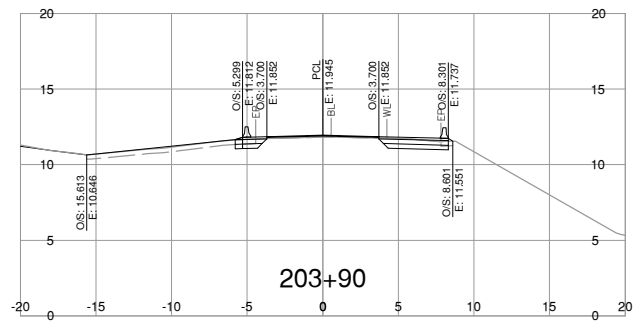
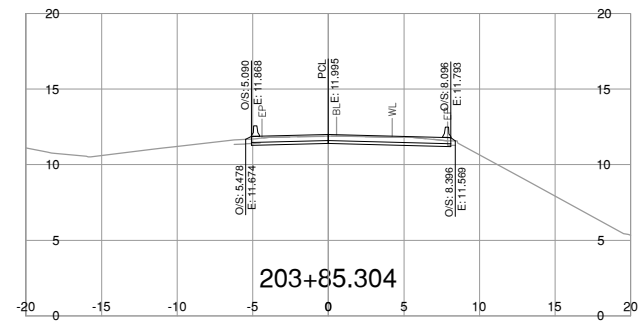

NOTE: STRIPPING REMOVAL APPLIES ONLY TO THE AREA BETWEEN SLOPE STAKE LINES (TOES & TOP OF CUT) OF PROPOSED ROADWAY TEMPLATE

FOR REFERENCE ONLY

DRAFT

BINNIE
The people behind your infrastructure.

R.F. BINNIE & ASSOCIATES LTD.
300 - 4940 Canada Way,
Burnaby, BC V5G 4K6
TEL 604 420 1721
BINNIE.com

BRITISH COLUMBIA

MINISTRY OF TRANSPORTATION AND INFRASTRUCTURE
SOUTH COAST REGION
HIGHWAY ENGINEERING AND GEOMATICS

SCALE 0 2 1:250 12m

CAD FILENAME SECT-L200_22-0383.DWG
DATE 2023-10-11
FILE NUMBER 22-0383

REV	DATE	REVISIONS	SIGNATURE

L200-LINE CROSS SECTIONS
HIGHWAY No. 1
COLQUITZ BRIDGES RETROFIT AND BUS LANE EXTENSION

DESIGNED	_____	M.C.	DATE	OCT 2023
QUALITY CONTROL	_____	M.C.	DATE	OCT 2023
QUALITY ASSURANCE	_____	M.C.	DATE	OCT 2023
DRAWN	_____	J.T.	DATE	OCT 2023
PROJECT NUMBER	17065-0001	REG	1	DRAWING NUMBER
				R1-1060-L200XS-4

04.11.2023 01:21 PM P:\2022\22-038300 - CAD Files\00-Design\Sections\Drawing\Production\1000 - Design\Sections\SECT-L200_22-0383

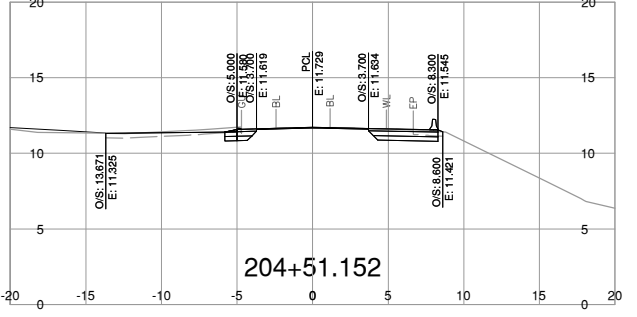
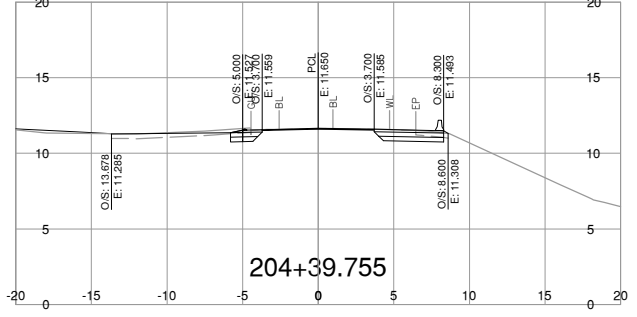
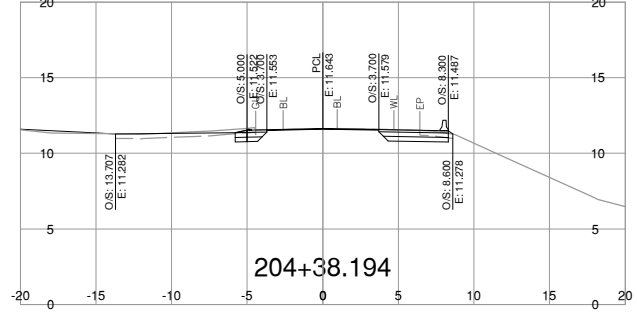
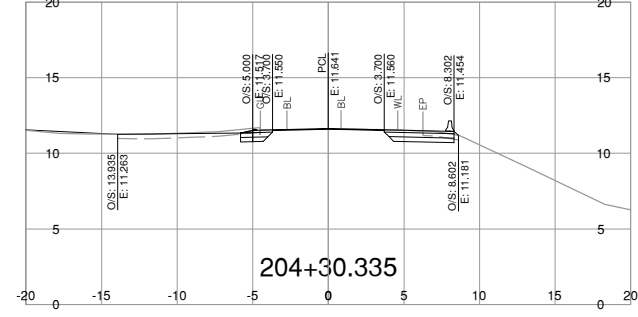
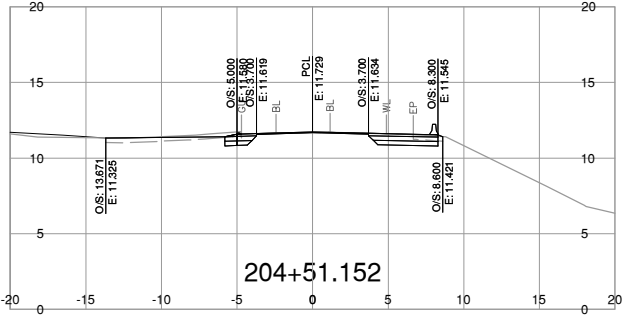
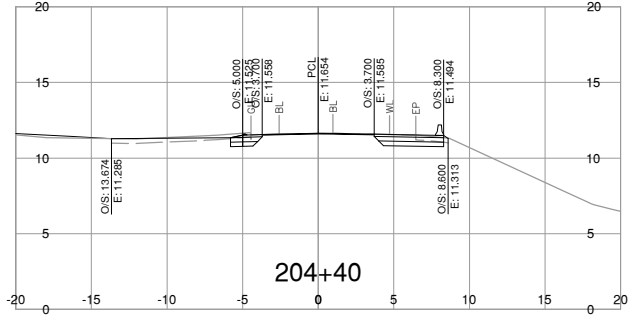
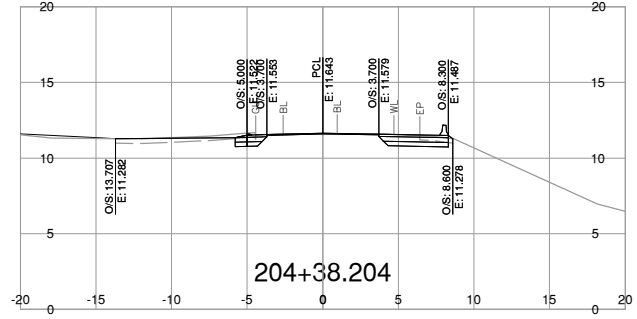
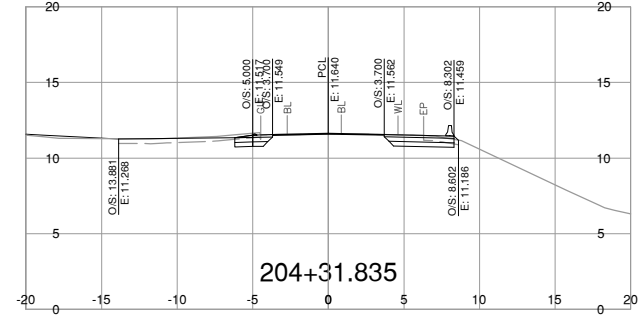
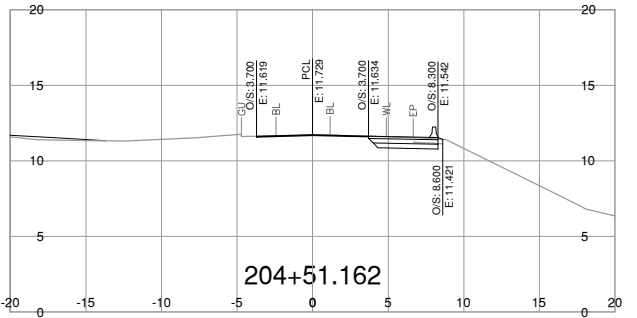
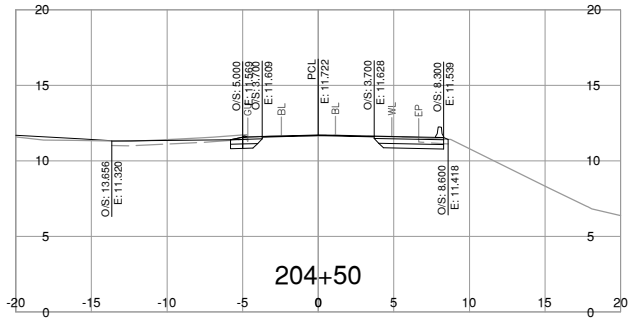
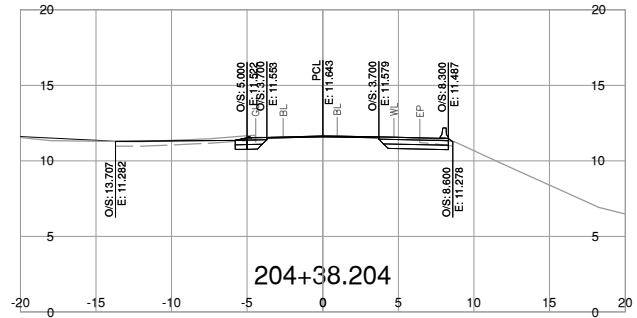
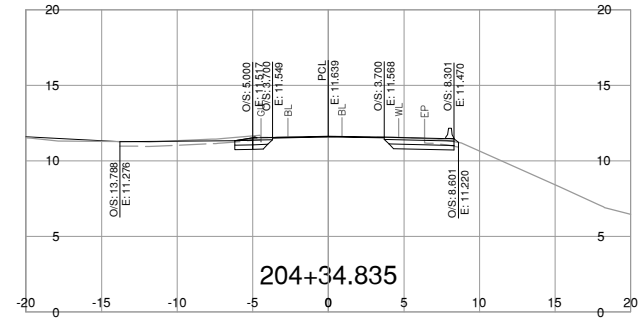
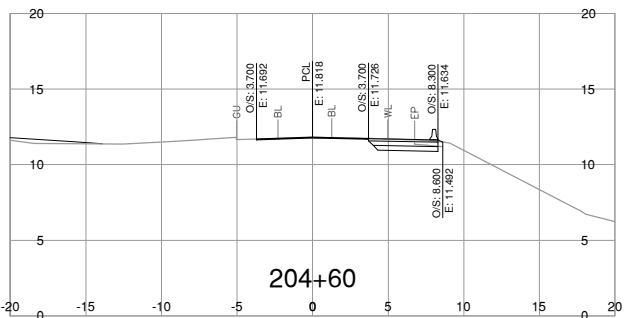
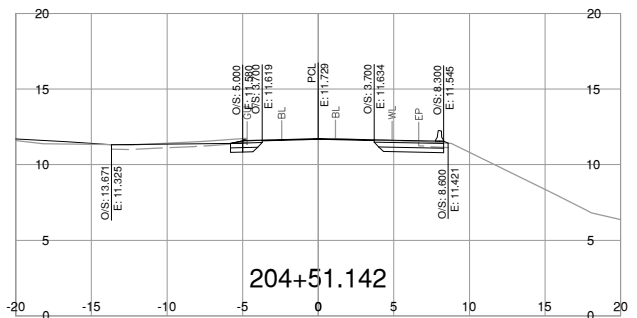
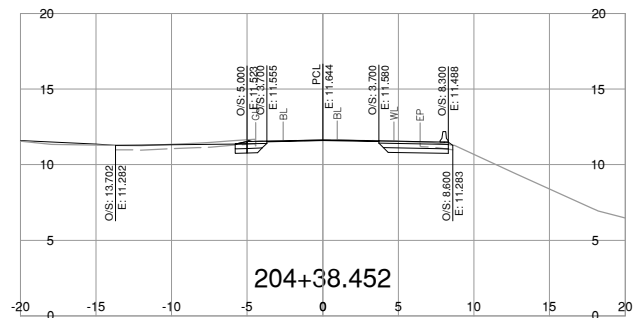
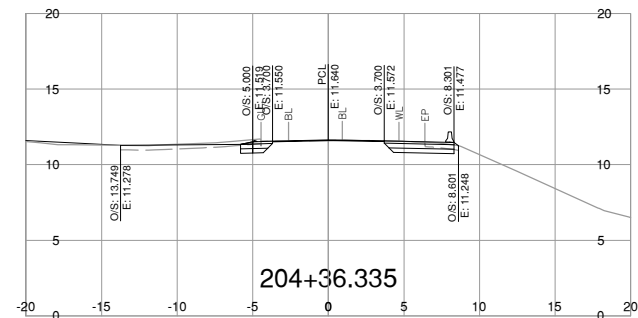

NOTE: STRIPPING REMOVAL APPLIES ONLY TO THE AREA BETWEEN SLOPE STAKE LINES (TOES & TOP OF CUT) OF PROPOSED ROADWAY TEMPLATE

FOR REFERENCE ONLY

DRAFT

BINNIE
The people behind your infrastructure.

R.F. BINNIE & ASSOCIATES LTD.
300 - 4940 Canada Way,
Burnaby, BC V5G 4K6
TEL 604 420 1721
BINNIE.com

BRITISH COLUMBIA
MINISTRY OF TRANSPORTATION AND INFRASTRUCTURE
SOUTH COAST REGION
HIGHWAY ENGINEERING AND GEOMATICS

L200-LINE CROSS SECTIONS
HIGHWAY No. 1
COLQUITZ BRIDGES RETROFIT AND BUS LANE EXTENSION

SCALE

CAD FILENAME: SECT-L200_22-0383.DWG
DATE: 2023-10-11
FILE NUMBER: 22-0383

REV	DATE	REVISIONS	SIGNATURE

DESIGNED	_____	M.C.	DATE	_____	OCT_2023
QUALITY CONTROL	_____	M.C.	DATE	_____	OCT_2023
QUALITY ASSURANCE	_____	M.C.	DATE	_____	OCT_2023
DRAWN	_____	J.T.	DATE	_____	OCT_2023
PROJECT NUMBER	17065-0001	REG	1	DRAWING NUMBER	R1-1060-L200XS-5

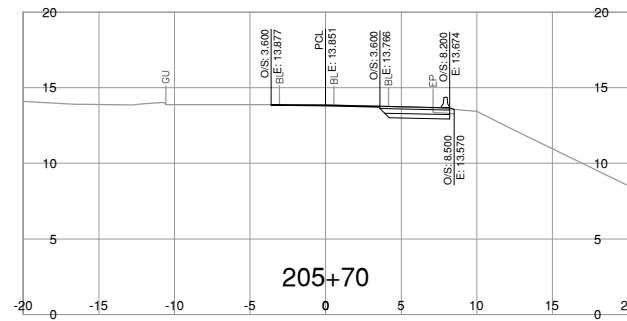
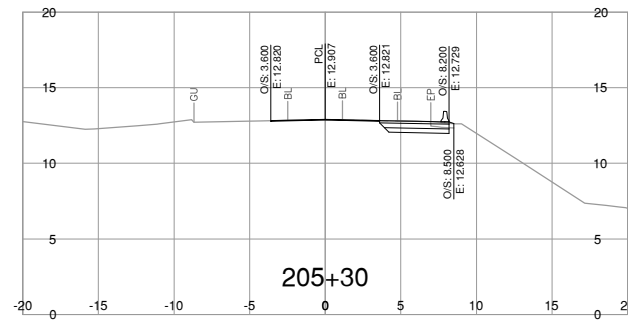
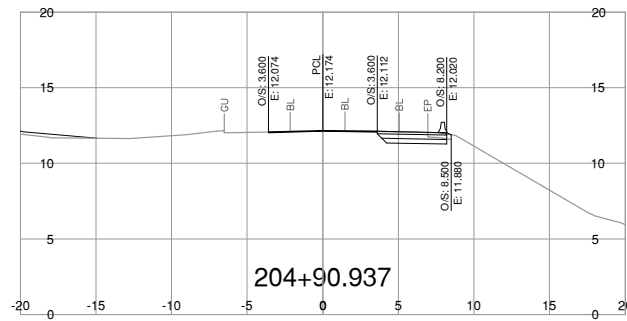
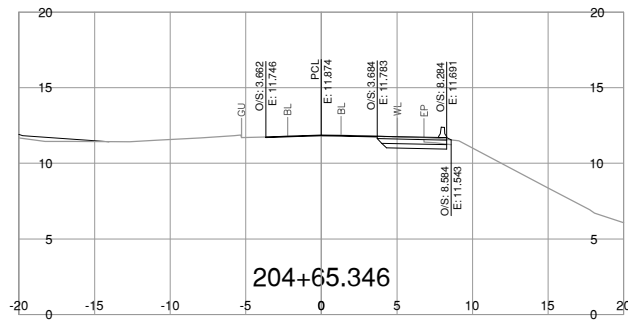
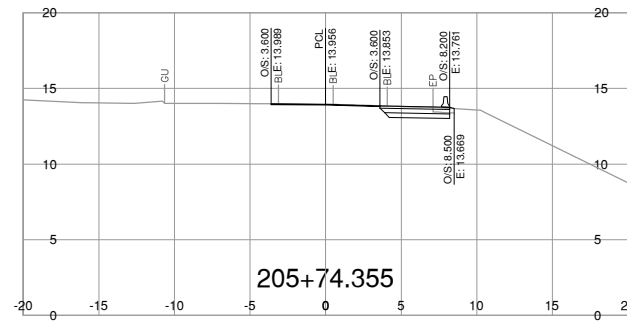
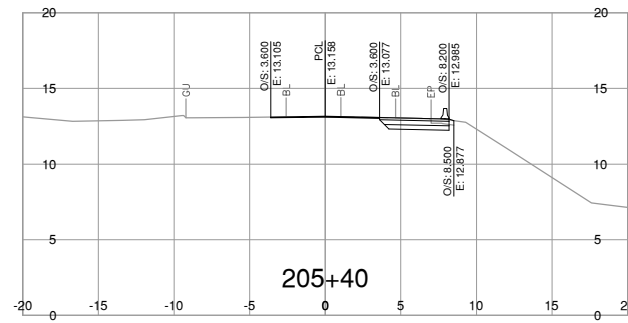
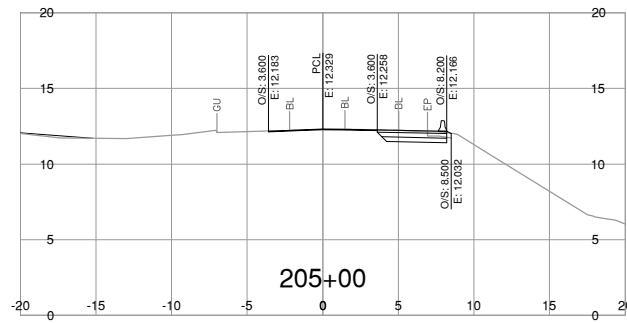
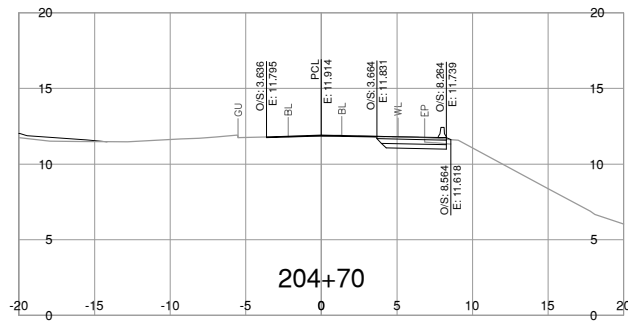
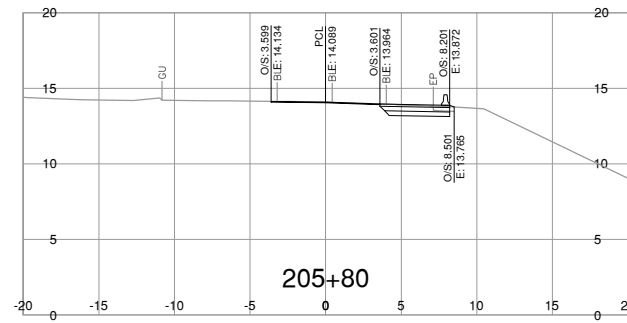
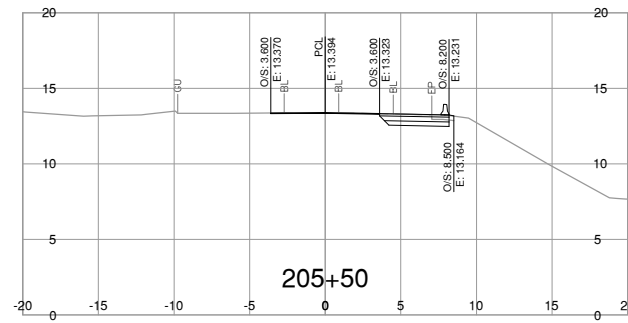
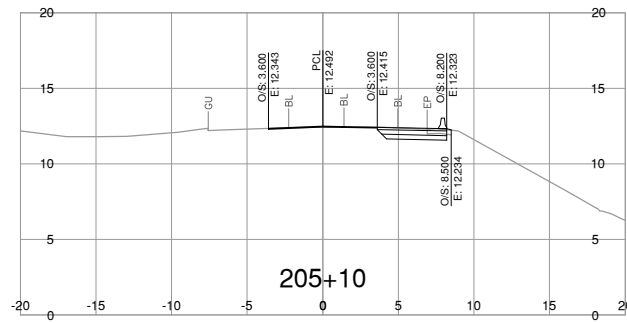
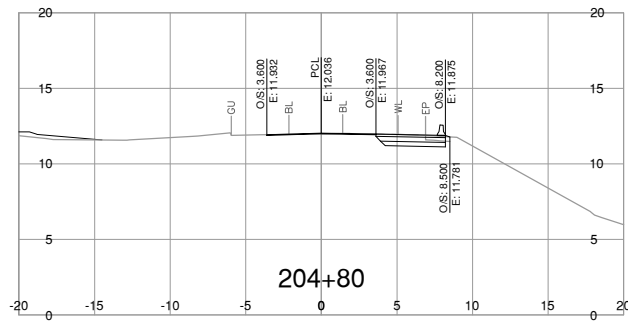
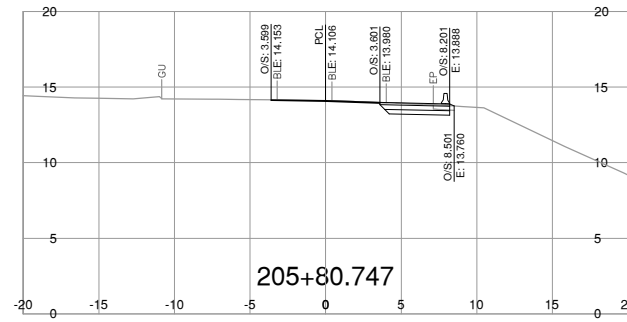
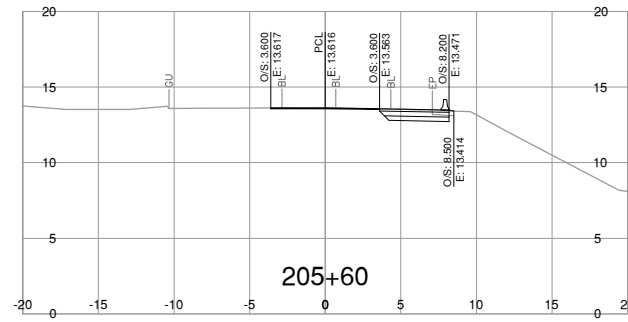
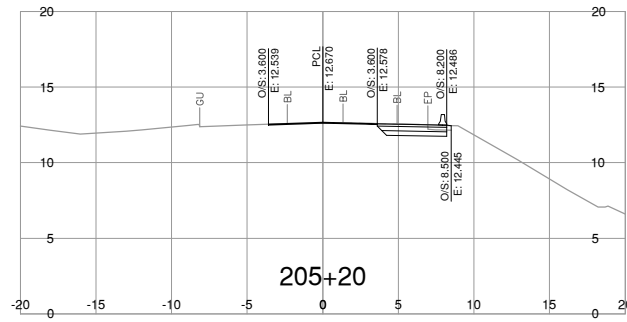
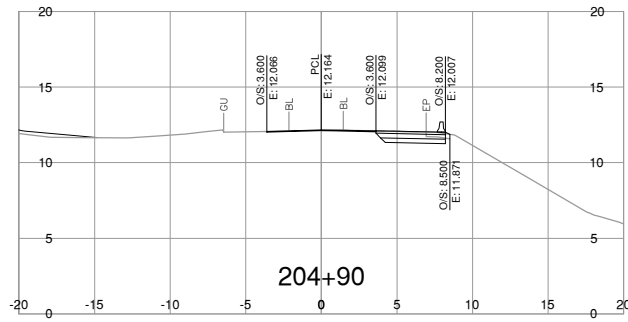

NOTE: STRIPPING REMOVAL APPLIES ONLY TO THE AREA BETWEEN SLOPE STAKE LINES (TOES & TOP OF CUT) OF PROPOSED ROADWAY TEMPLATE

FOR REFERENCE ONLY

DRAFT

BINNIE
The people behind your infrastructure.

R.F. BINNIE & ASSOCIATES LTD.
300 - 4940 Canada Way,
Burnaby, BC V5G 4K6
TEL 604 420 1721
BINNIE.com

BRITISH COLUMBIA

MINISTRY OF TRANSPORTATION AND INFRASTRUCTURE
SOUTH COAST REGION
HIGHWAY ENGINEERING AND GEOMATICS

SCALE CAD FILENAME SECT-L200-22-0393.DWG DATE 2023-10-11

FILE NUMBER 22-0393

REV	DATE	REVISIONS	SIGNATURE

L200-LINE CROSS SECTIONS
HIGHWAY No. 1
COLQUITZ BRIDGES RETROFIT AND BUS LANE EXTENSION

DESIGNED	_____	M.C.	DATE	<u>OCT 2023</u>	
QUALITY CONTROL	_____	M.C.	DATE	<u>OCT 2023</u>	
QUALITY ASSURANCE	_____	M.C.	DATE	<u>OCT 2023</u>	
DRAWN	_____	J.T.	DATE	<u>OCT 2023</u>	
PROJECT NUMBER	<u>17065-0001</u>	REG	<u>1</u>	DRAWING NUMBER	<u>R1-1060-L200XS-6</u>

C:\11_2023_0121_PM_P\2022\22-0393\00 - CAD Files\00-Comp\Bridges\Drawings\Production\1000_Design\Sections\SECT-L200_22-0393

C:\11_2023_0121 PM P:\2022\22-038300 - CAD Files\00-Design\Drawings\Production\1000_Design\Sections\SECT_L200_22-0383

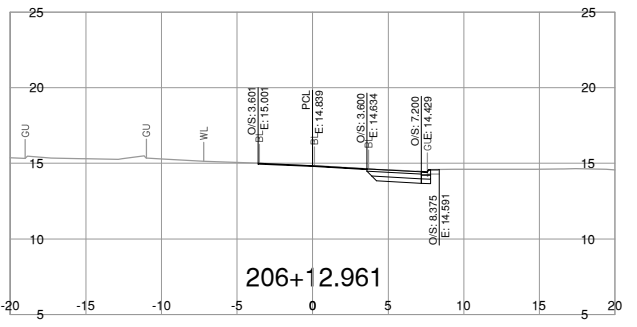
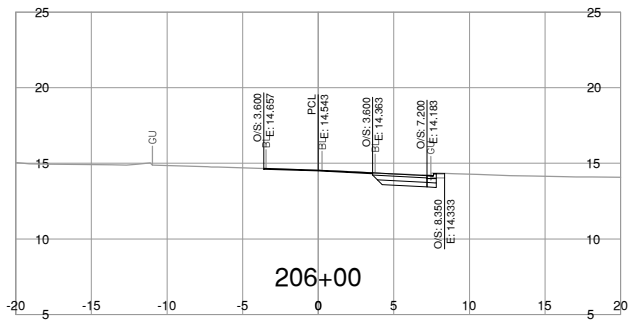
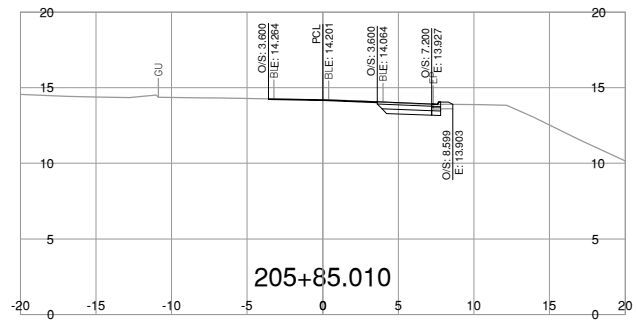
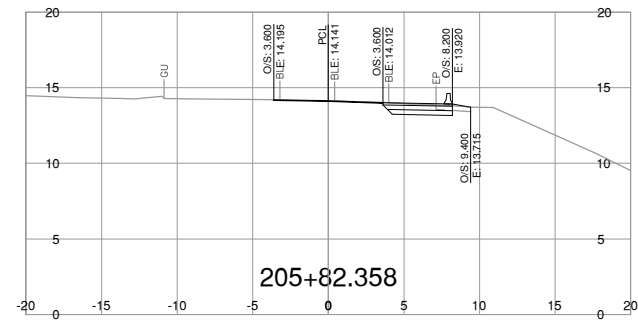
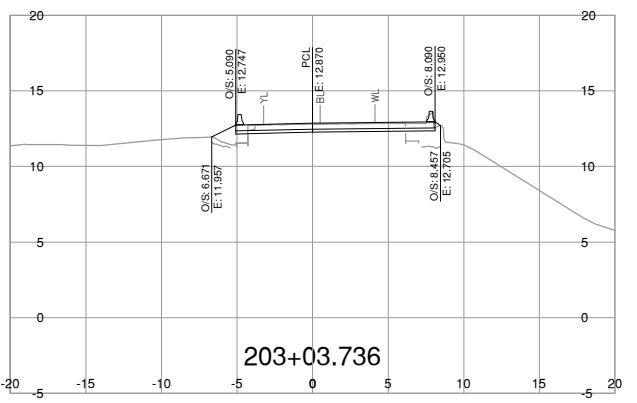
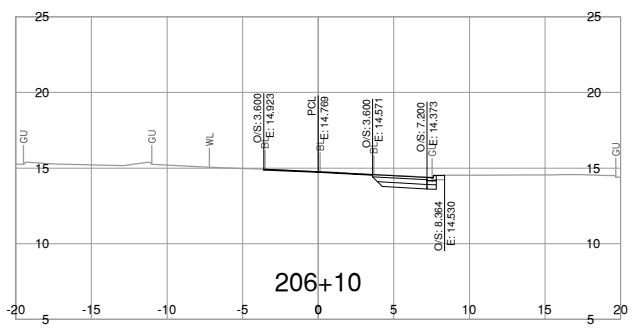
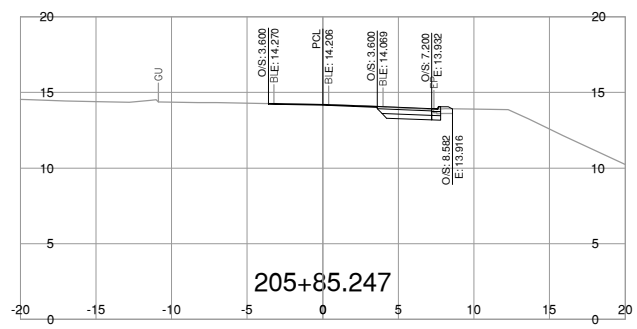
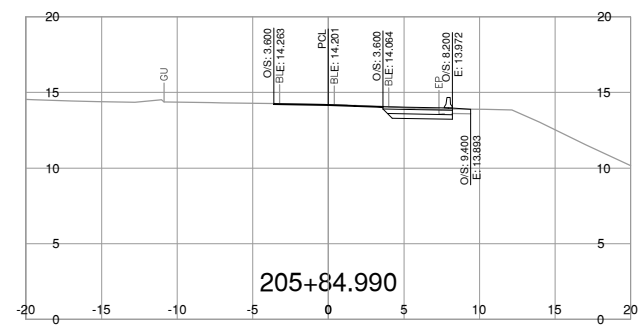
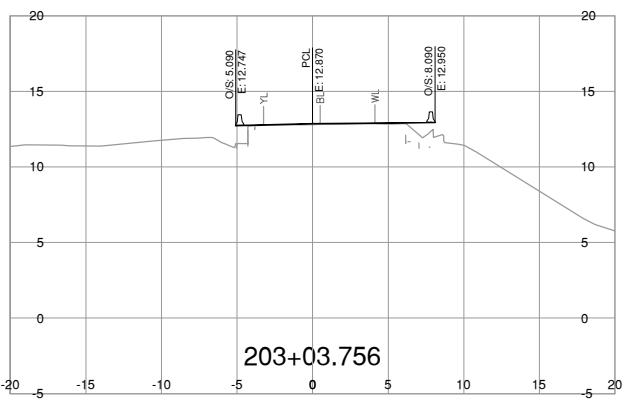
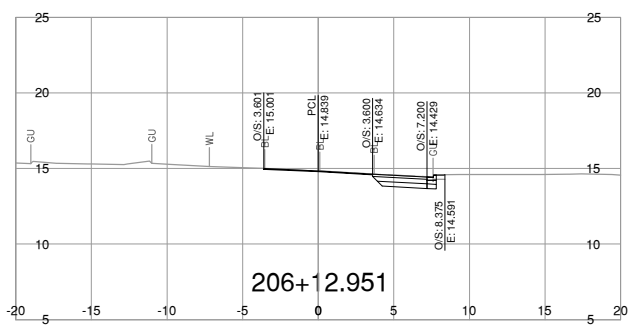
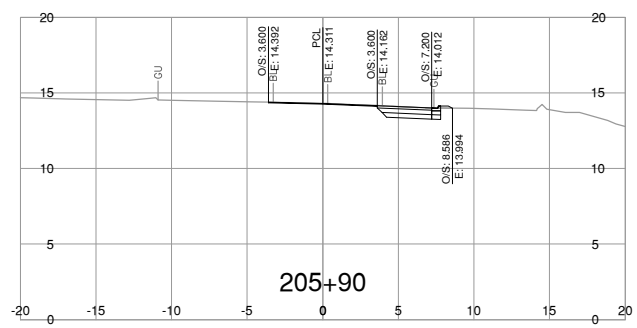
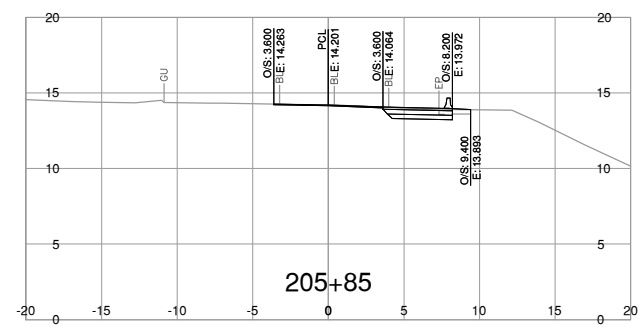

NOTE: STRIPPING REMOVAL APPLIES ONLY TO THE AREA BETWEEN SLOPE STAKE LINES (TOES & TOP OF CUT) OF PROPOSED ROADWAY TEMPLATE

FOR REFERENCE ONLY

DRAFT



BINNIE
The people behind your infrastructure.

R.F. BINNIE & ASSOCIATES LTD.
300 - 4940 Canada Way,
Burnaby, BC V5G 4K6
TEL 604 420 1721
BINNIE.com



BRITISH COLUMBIA
MINISTRY OF TRANSPORTATION AND INFRASTRUCTURE
SOUTH COAST REGION
HIGHWAY ENGINEERING AND GEOMATICS

L200-LINE CROSS SECTIONS
HIGHWAY No. 1
COLQUITZ BRIDGES RETROFIT AND BUS LANE EXTENSION

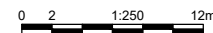
SCALE  CAD FILENAME SECT-L200_22-0383.DWG
DATE 2023-10-11
FILE NUMBER 22-0383

REV	DATE	REVISIONS	SIGNATURE

DESIGNED	_____	M.C.	DATE	_____	OCT 2023
QUALITY CONTROL	_____	M.C.	DATE	_____	OCT 2023
QUALITY ASSURANCE	_____	M.C.	DATE	_____	OCT 2023
DRAWN	_____	J.T.	DATE	_____	OCT 2023
PROJECT NUMBER	17065-0001	REG	1	DRAWING NUMBER	R1-1060-L200XS-7

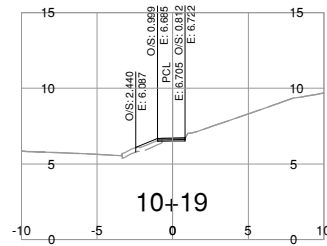
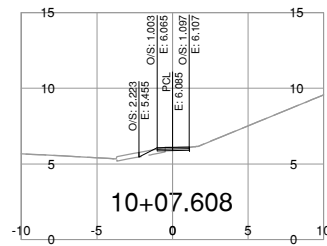
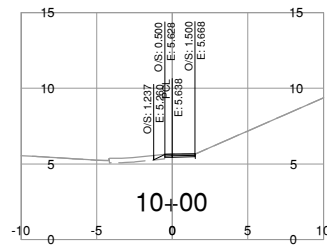
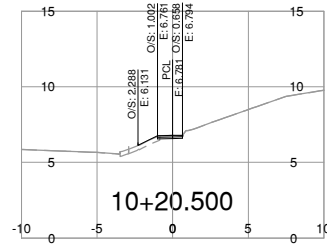
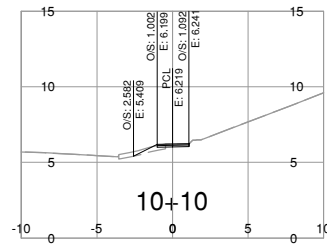
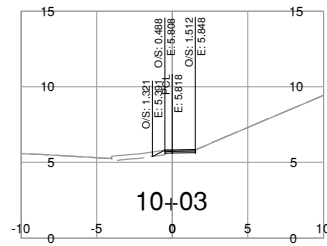
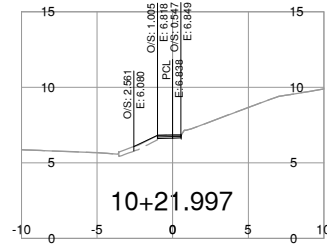
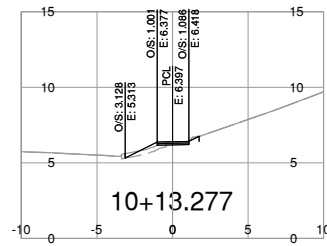
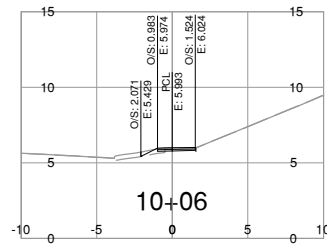
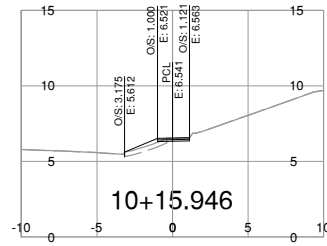
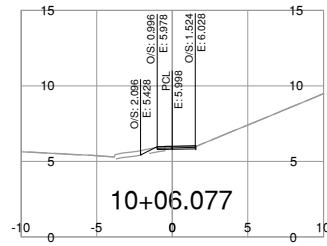
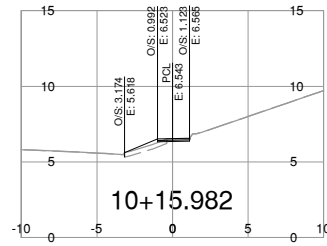
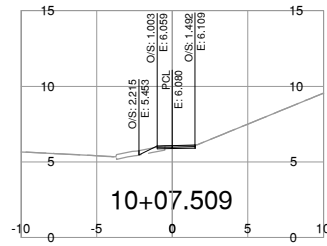

NOTE: STRIPPING REMOVAL APPLIES ONLY TO THE AREA BETWEEN SLOPE STAKE LINES (TOES & TOP OF CUT) OF PROPOSED ROADWAY TEMPLATE

FOR REFERENCE ONLY

DRAFT

		R.F. BINNIE & ASSOCIATES LTD. 300 - 4940 Canada Way, Burnaby, BC V5G 4K6 TEL 604 420 1721 BINNIE.com		BRITISH COLUMBIA		MINISTRY OF TRANSPORTATION AND INFRASTRUCTURE SOUTH COAST REGION HIGHWAY ENGINEERING AND GEOMATICS																																											
SCALE 0 2 1:250 12m		CAD FILENAME SECT-L10-22-0393.DWG		DATE 2023-09-28		L10-LINE CROSS SECTIONS HIGHWAY No. 1 COLQUITZ BRIDGES RETROFIT AND BUS LANE EXTENSION																																											
FILE NUMBER 22-0393		<table border="1"> <thead> <tr> <th>REV</th> <th>DATE</th> <th>REVISIONS</th> <th>SIGNATURE</th> </tr> </thead> <tbody> <tr><td> </td><td> </td><td> </td><td> </td></tr> <tr><td> </td><td> </td><td> </td><td> </td></tr> <tr><td> </td><td> </td><td> </td><td> </td></tr> <tr><td> </td><td> </td><td> </td><td> </td></tr> <tr><td> </td><td> </td><td> </td><td> </td></tr> <tr><td> </td><td> </td><td> </td><td> </td></tr> <tr><td> </td><td> </td><td> </td><td> </td></tr> <tr><td> </td><td> </td><td> </td><td> </td></tr> <tr><td> </td><td> </td><td> </td><td> </td></tr> <tr><td> </td><td> </td><td> </td><td> </td></tr> </tbody> </table>		REV	DATE	REVISIONS	SIGNATURE																																									DESIGNED _____ M.C. DATE OCT 2023 QUALITY CONTROL _____ M.C. DATE OCT 2023 QUALITY ASSURANCE _____ M.C. DATE OCT 2023 DRAWN _____ J.T. DATE OCT 2023	
REV	DATE	REVISIONS	SIGNATURE																																														
PROJECT NUMBER 17065-0001		REG 1		DRAWING NUMBER R1-1060-L10XS-1		REV _____																																											

Oct 18, 2023 03:38 PM P:\2022\22-0393\00 - CAD Files\00-Design\Drawings\Production\1000 - Design\Sections\SECT-L30_22-0393

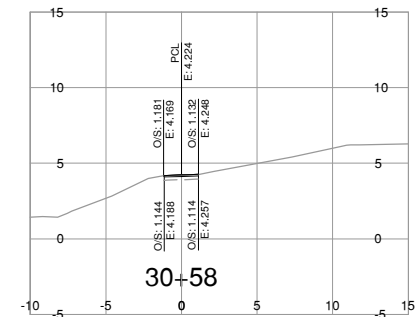
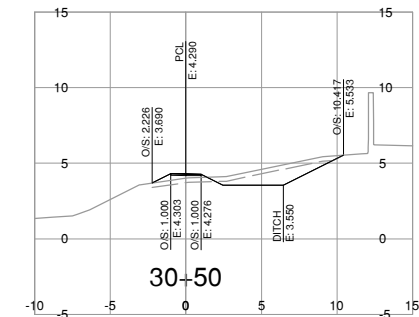
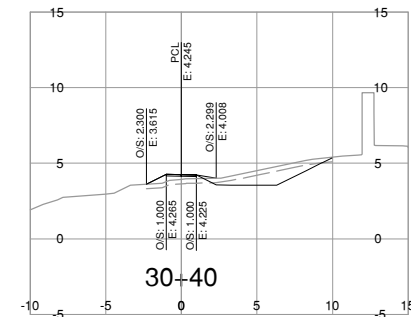
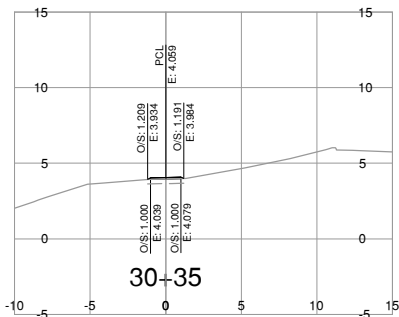
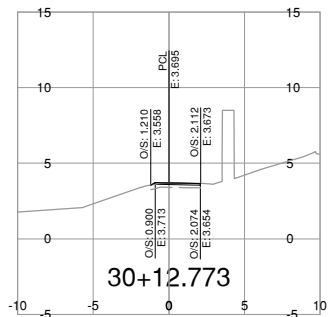
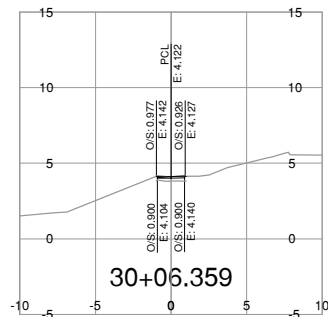
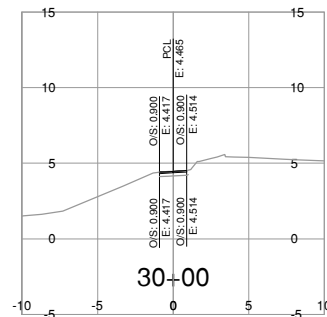
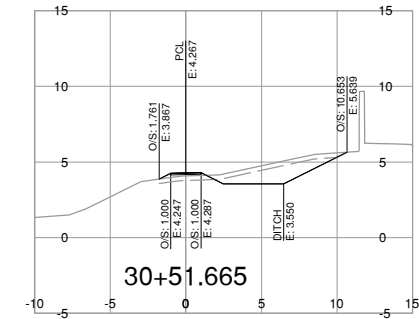
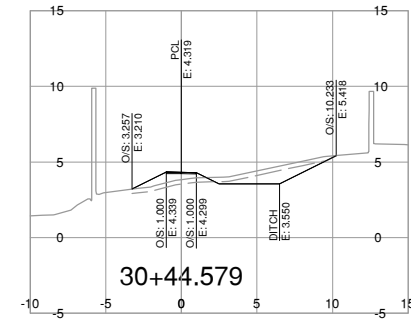
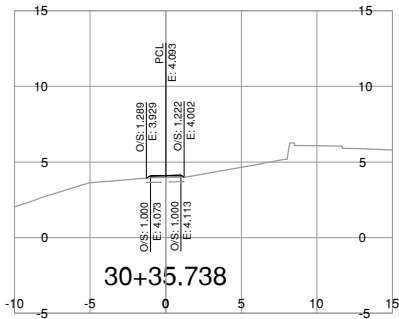
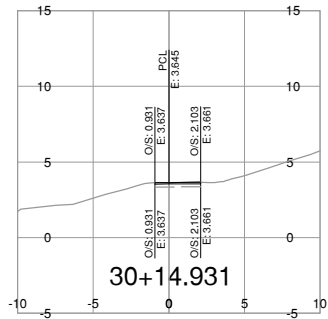
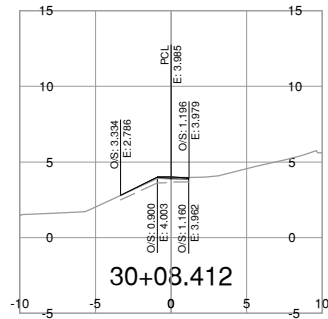
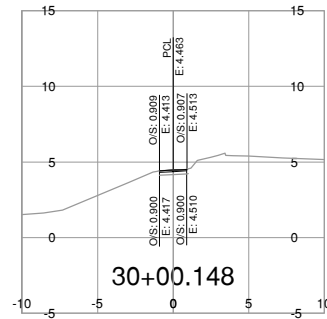
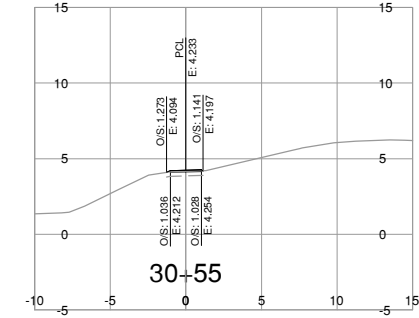
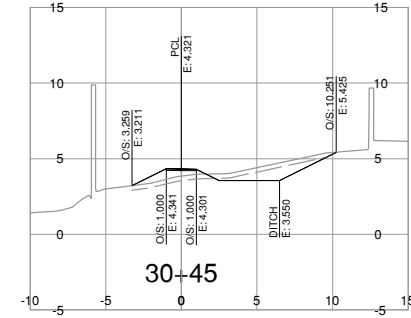
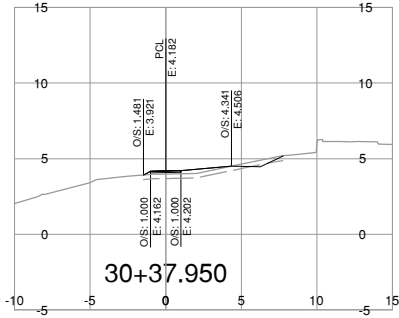
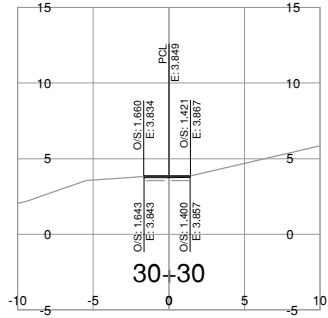
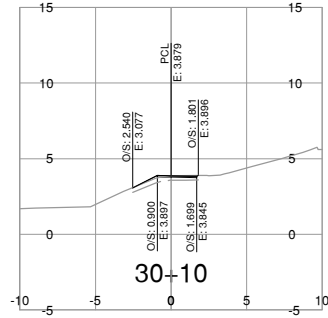
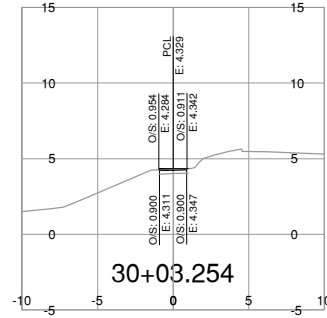
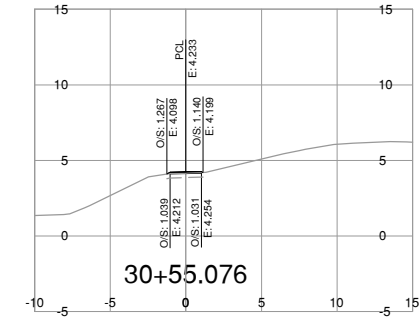
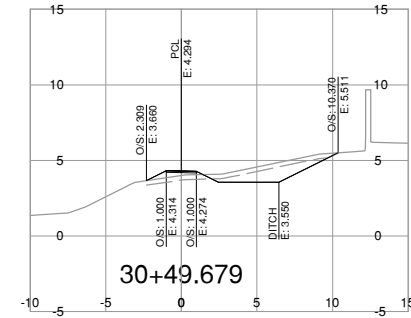
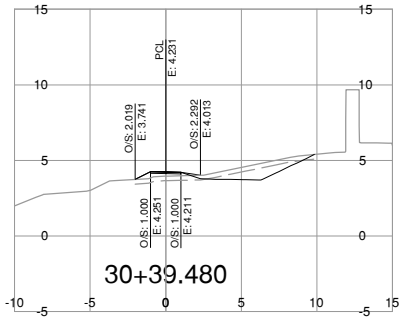
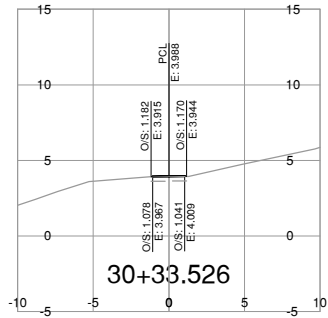
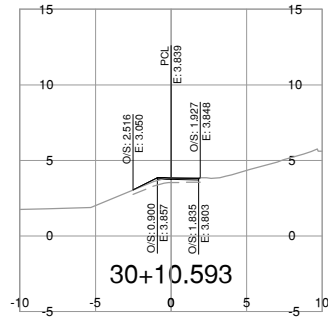
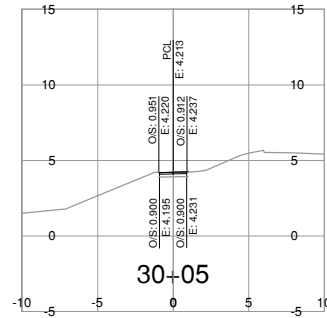

NOTE: STRIPPING REMOVAL APPLIES ONLY TO THE AREA BETWEEN SLOPE STAKE LINES (TOES & TOP OF CUT) OF PROPOSED ROADWAY TEMPLATE

FOR REFERENCE ONLY

DRAFT



BINNIE
The people behind your infrastructure.

R.F. BINNIE & ASSOCIATES LTD.
300 - 4940 Canada Way,
Burnaby, BC V5G 4K6
TEL 604 420 1721
BINNIE.com



BRITISH COLUMBIA
MINISTRY OF TRANSPORTATION AND INFRASTRUCTURE
SOUTH COAST REGION
HIGHWAY ENGINEERING AND GEOMATICS

L30-LINE CROSS SECTIONS
HIGHWAY No. 1
COLQUITZ BRIDGES RETROFIT AND BUS LANE EXTENSION

SCALE  0 2 1:250 12m

CAD FILENAME: SECT-L30_22-0393.DWG
DATE: 2023-10-16
FILE NUMBER: 22-0393

REV	DATE	REVISIONS	SIGNATURE

DESIGNED	_____	M.C.	DATE	_____	OCT 2023
QUALITY CONTROL	_____	M.C.	DATE	_____	OCT 2023
QUALITY ASSURANCE	_____	M.C.	DATE	_____	OCT 2023
DRAWN	_____	J.T.	DATE	_____	OCT 2023
PROJECT NUMBER	17065-0001	REG	1	DRAWING NUMBER	R1-1060-L30XS-1