

PLOT DATE: 2024/03/01 G:\Projects\32000\32800\32836_MoTI_Fulford_Conges_Road_Widening\02_CADD\DrawingProduction\1000_DesignSections\R1-989-1000.dwg

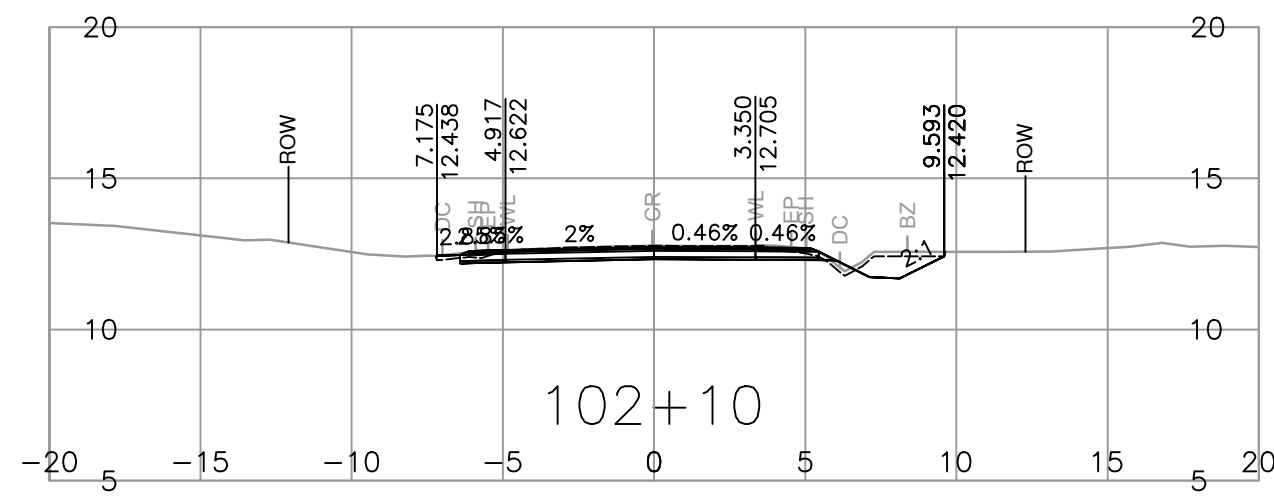
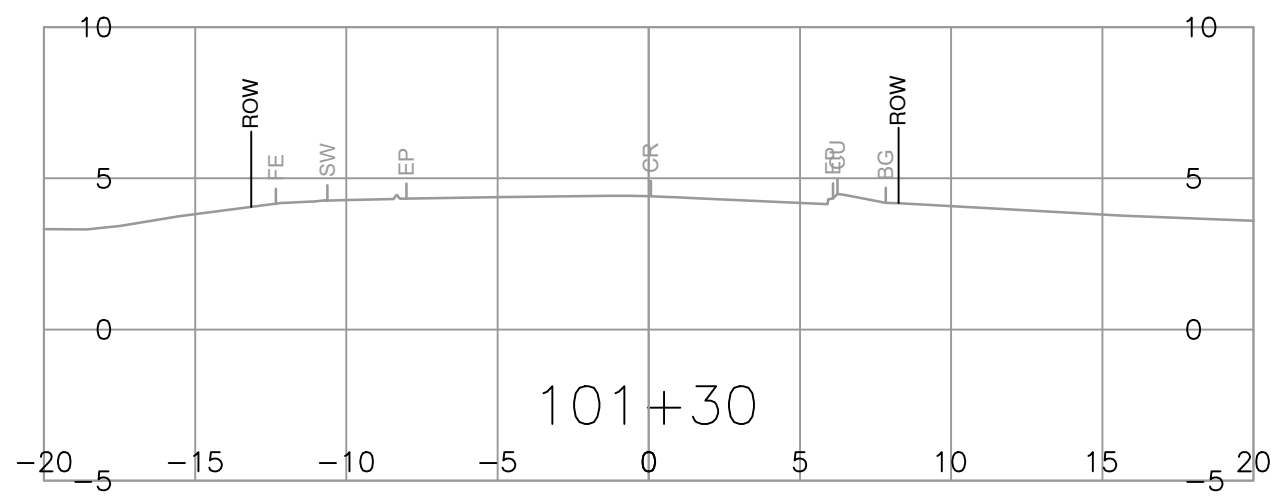
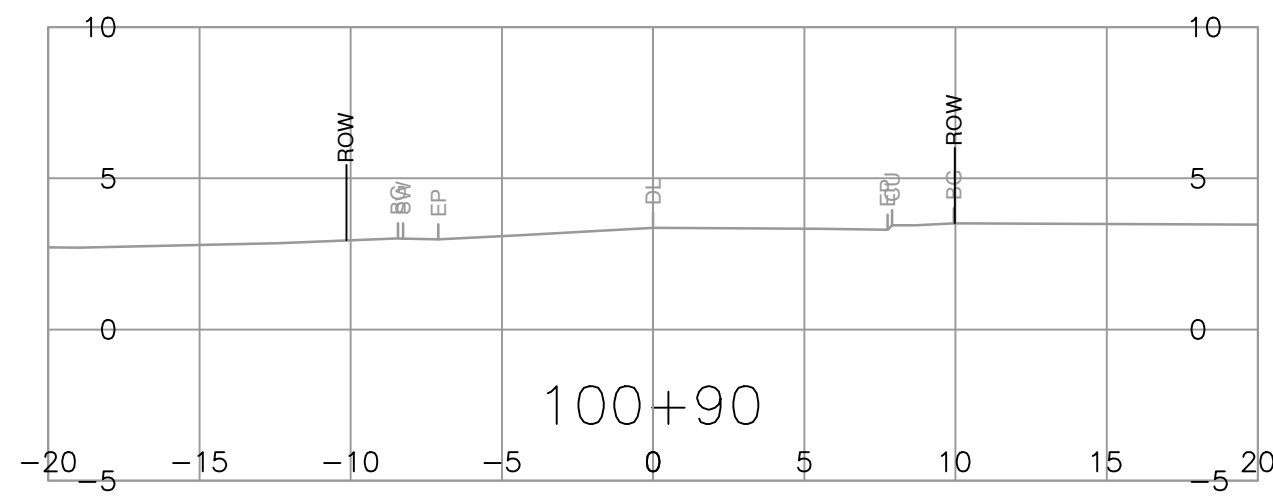
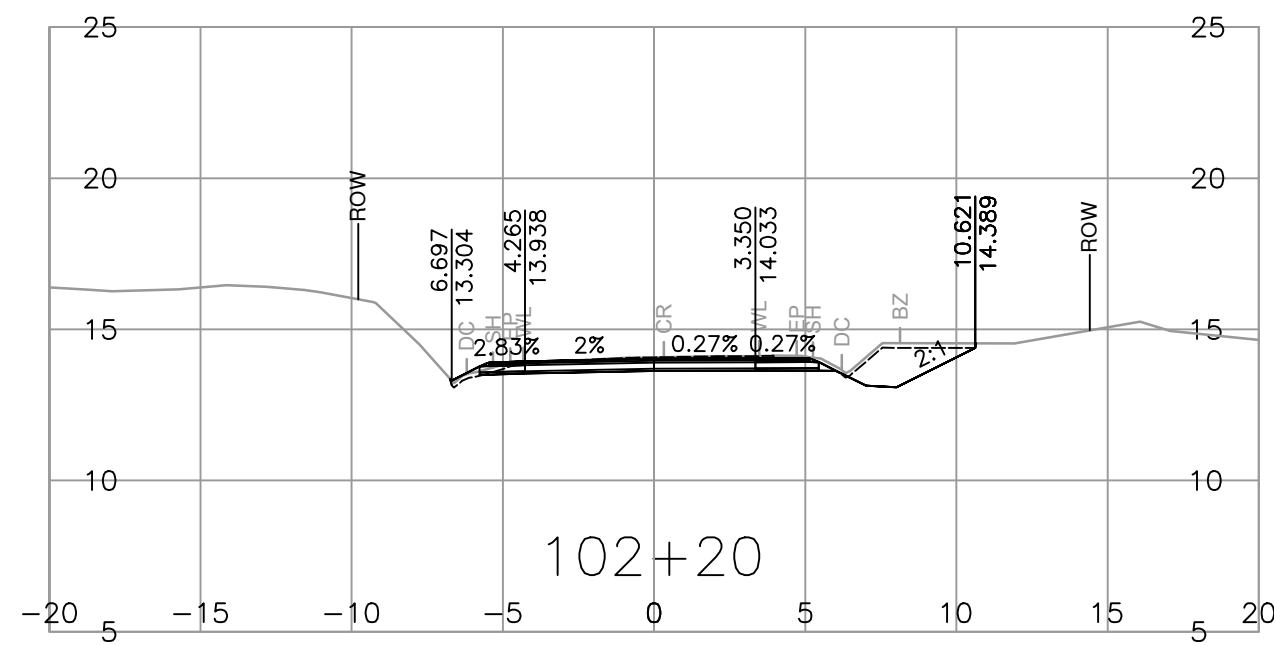
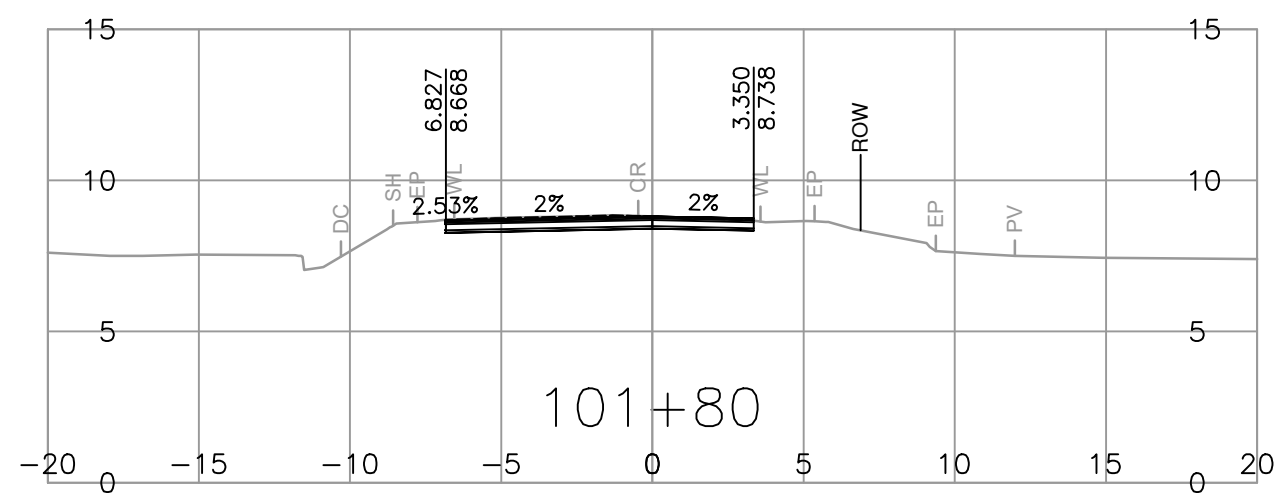
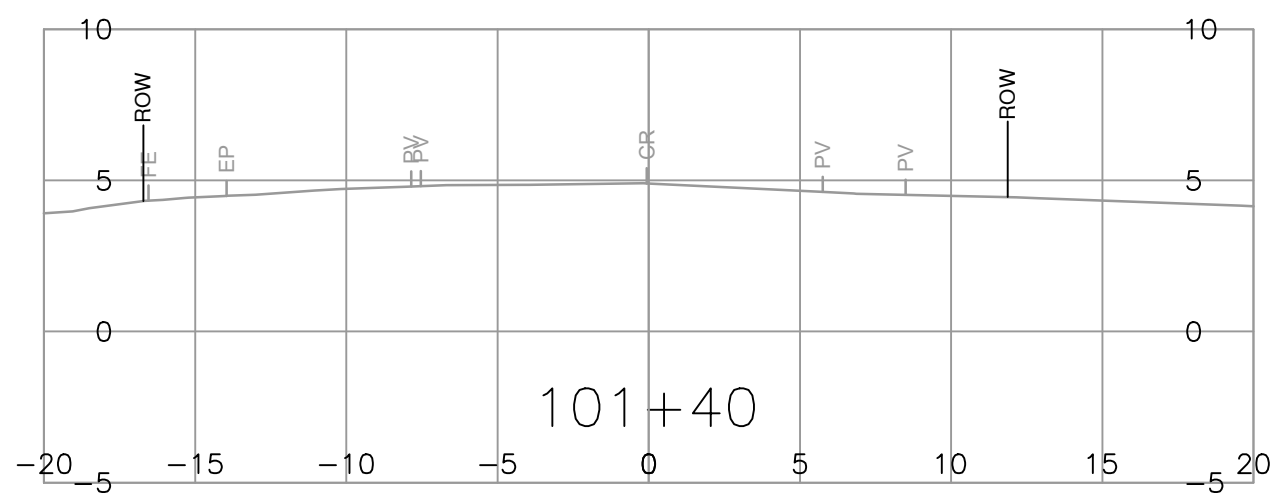
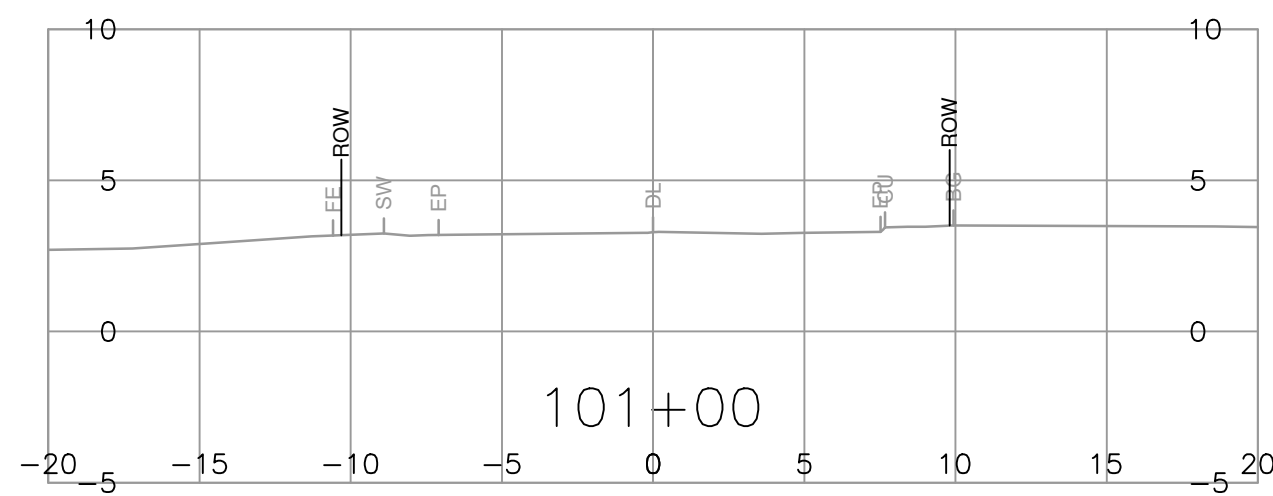
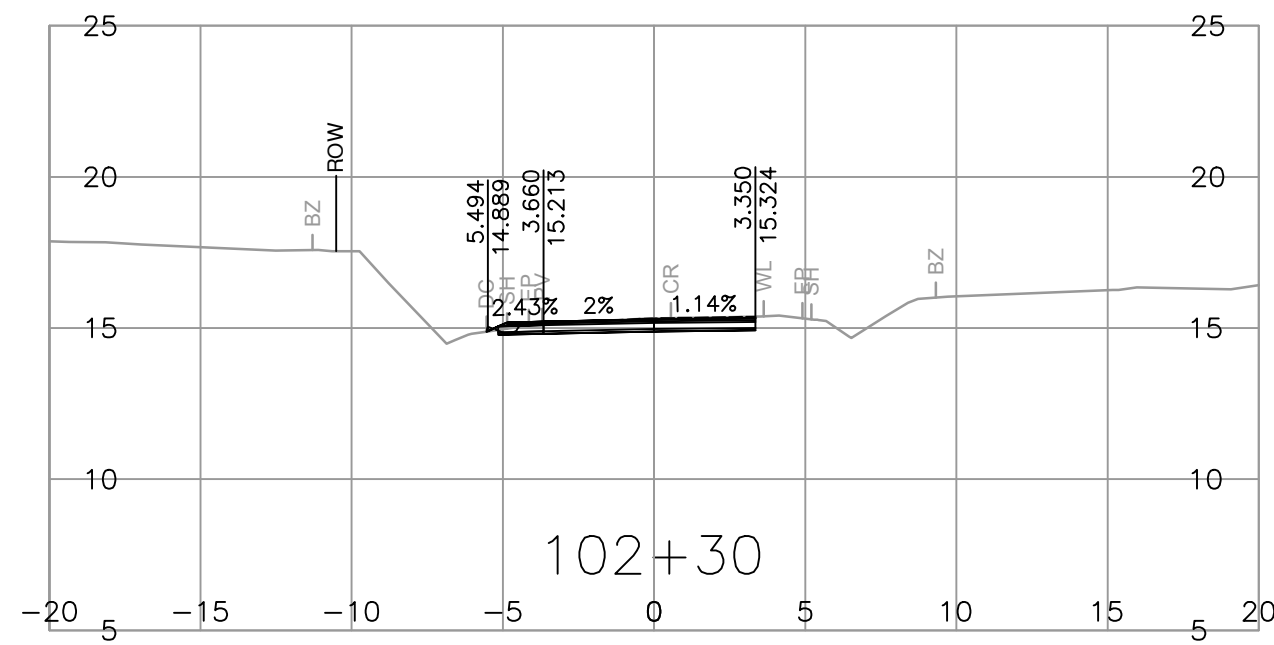
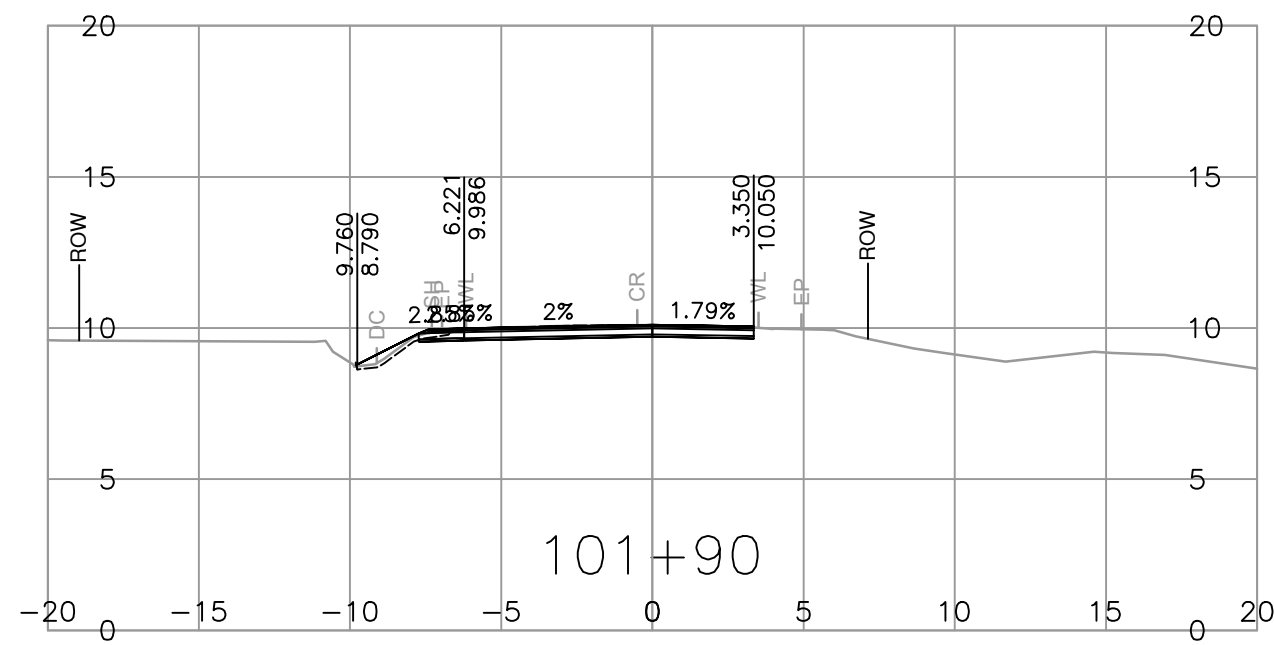
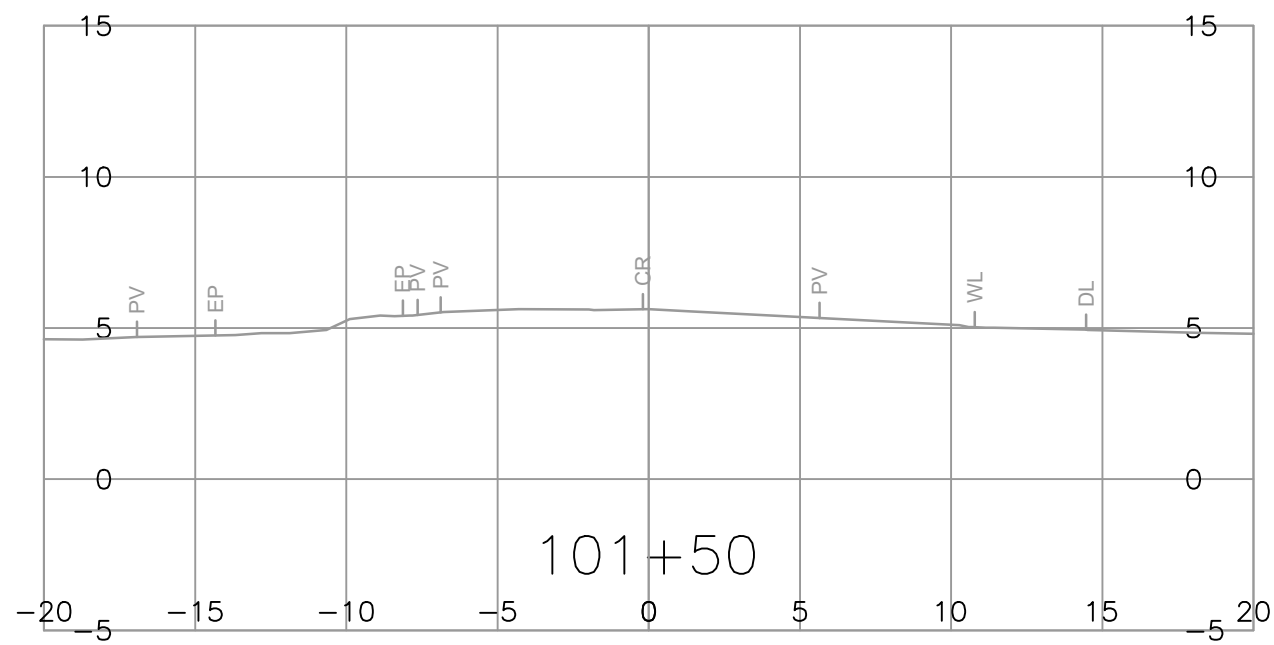
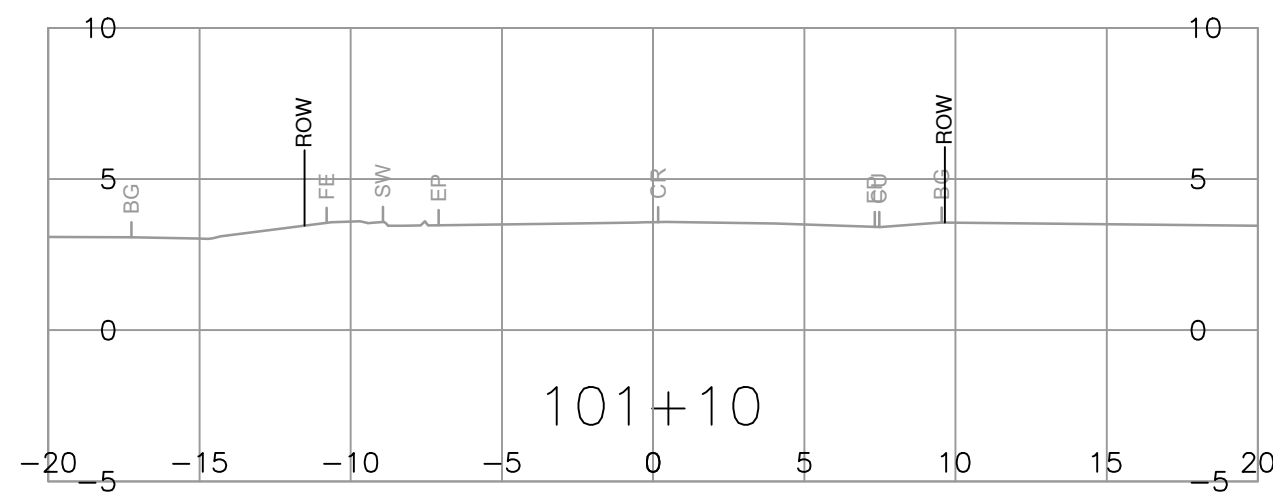
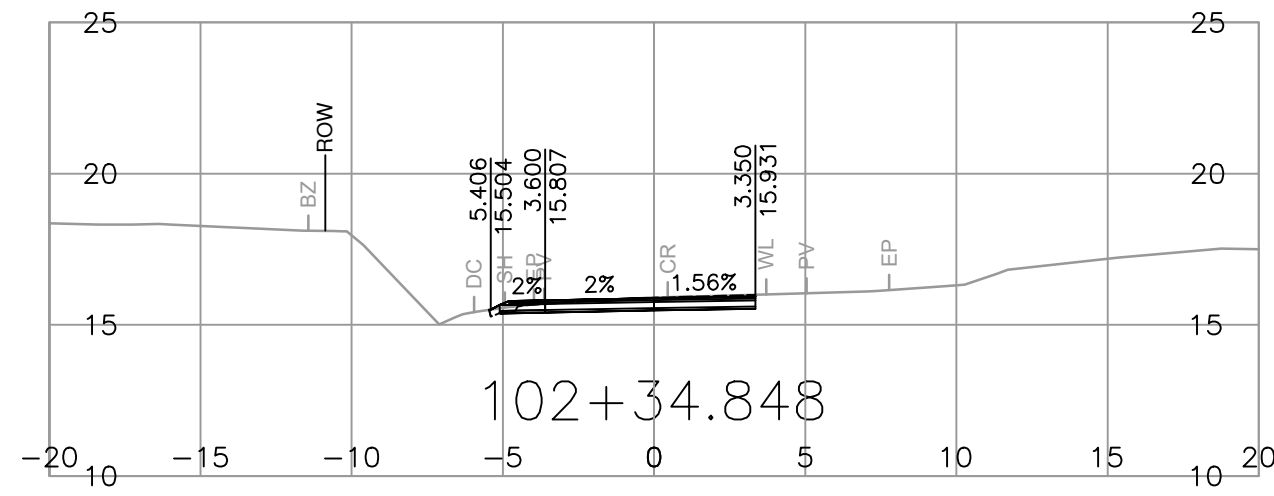
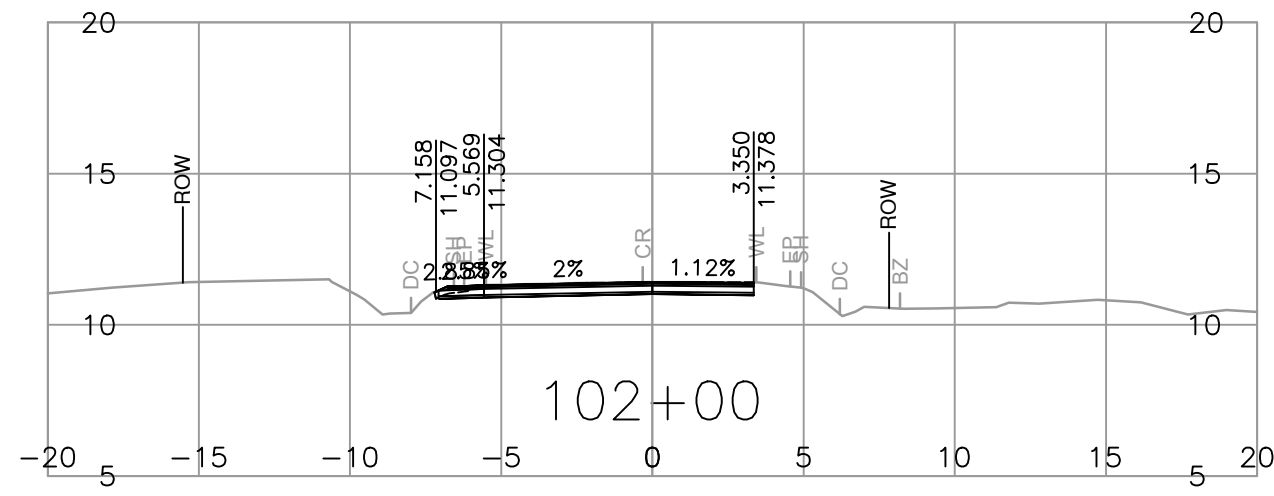
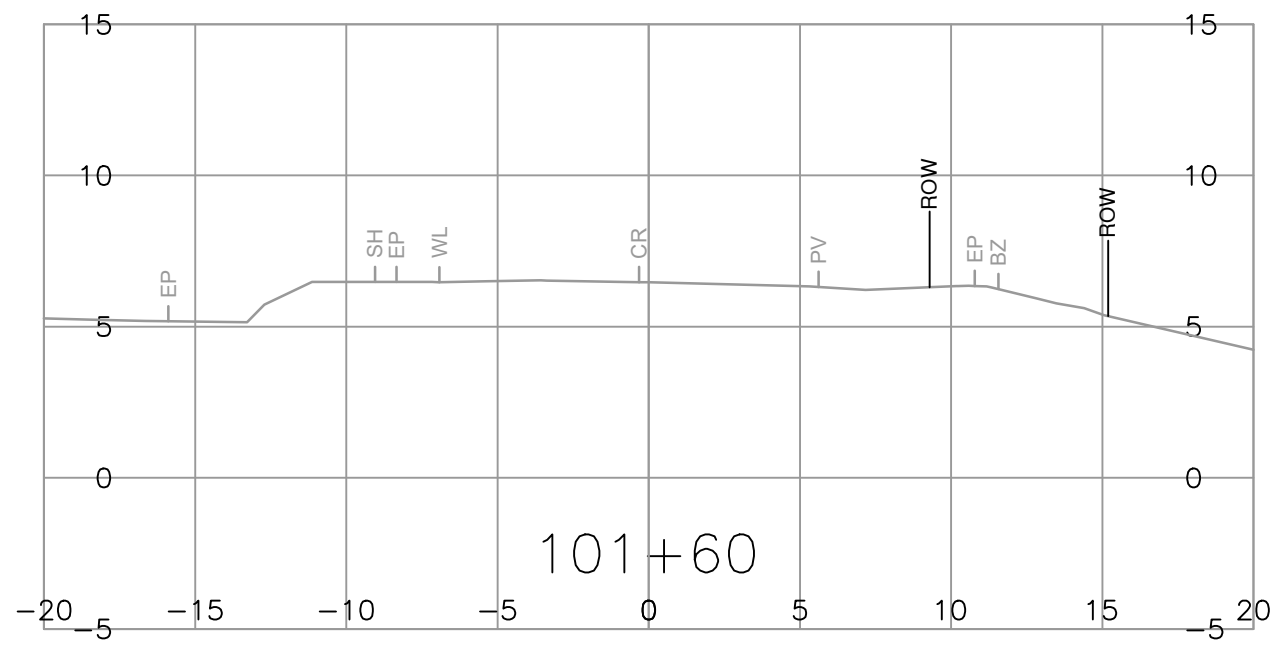
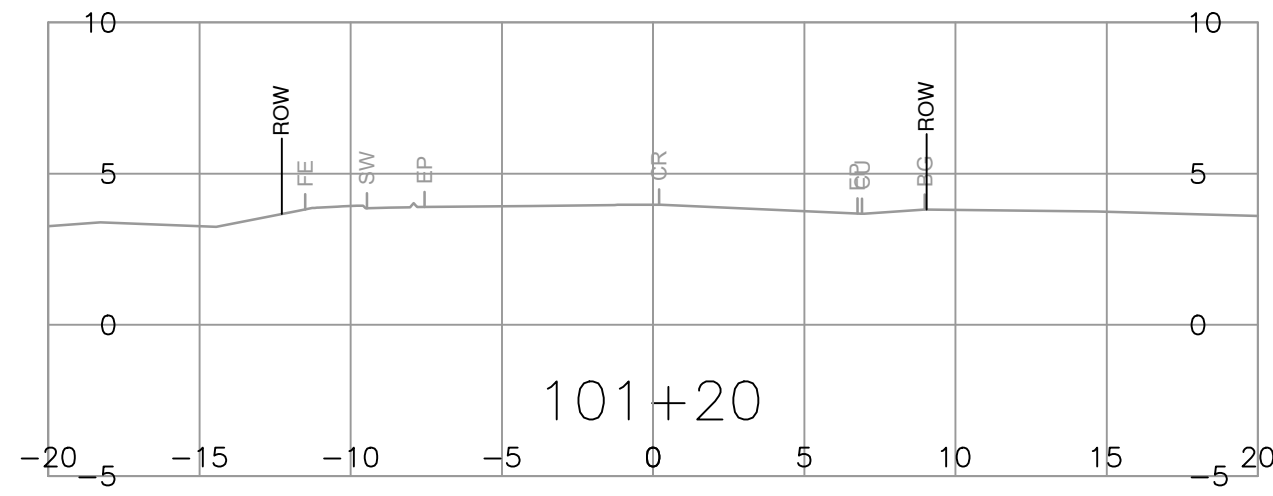

SUITE 201, 8506 - 200 STREET
LANGLEY, BRITISH COLUMBIA, V2Y 0M1
PH : 604.371.0091 FAX : 604.371.0098

SCALE 0 2 1:250 12m

CAD FILENAME R1-989-1000
PLOT DATE 2024-03-01



MINISTRY OF TRANSPORTATION AND INFRASTRUCTURE

SOUTH COAST REGION
VANCOUVER ISLAND DISTRICT



REV	DATE	REVISIONS	NAME

SENIOR DESIGNER
DATE

DESIGNED B. PEEBLES DATE 2024-02-01
QUALITY CONTROL Z. PENDON DATE 2024-02-01
QUALITY ASSURANCE A. SANTOS DATE 2024-02-01
DRAWN J. SHIM DATE 2024-02-01

TEMPLATE CROSS SECTIONS
FULFORD-GANGES ROAD IMPROVEMENT
SEAVIEW AVENUE TO CRANBERRY ROAD

L100

FILE NUMBER	PROJECT NUMBER	REG	DRAWING NUMBER	REV
32836	16873-0001	1	R1-989-1001	

PLOT DATE: 2024/03/01 G:\Projects\32000\32800\MoTL_Fulford_Ganges_Road_Widening\02_CADD\DrawingProduction\1000_DesignSections\R1-989-1000.dwg

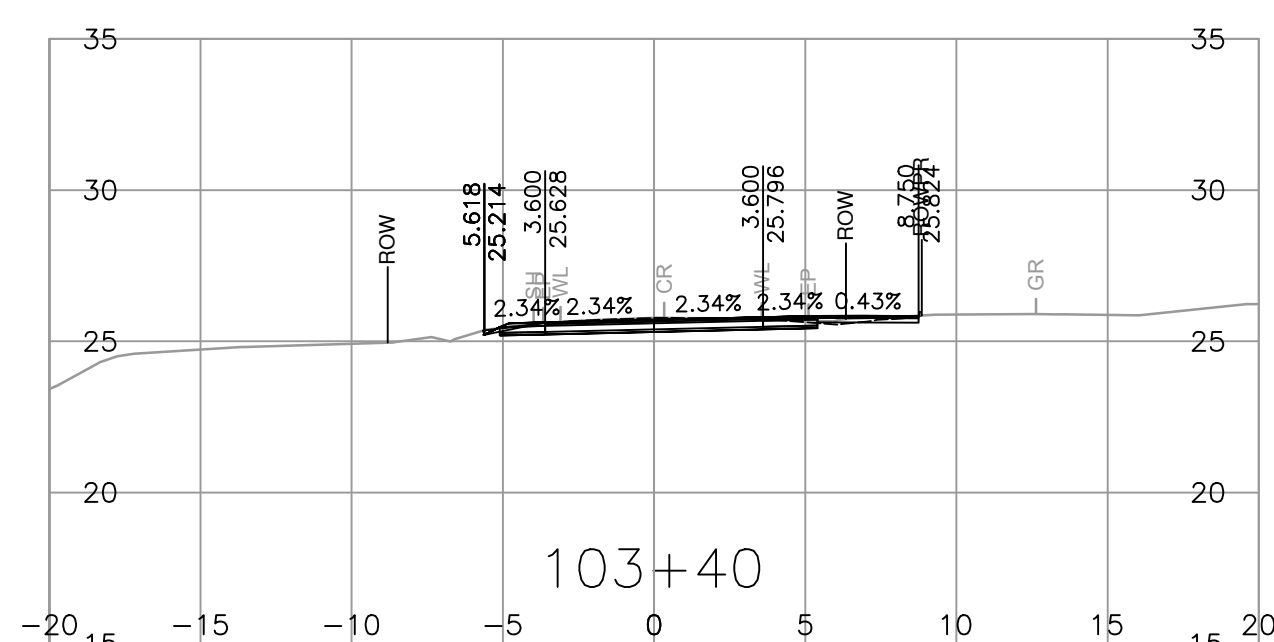
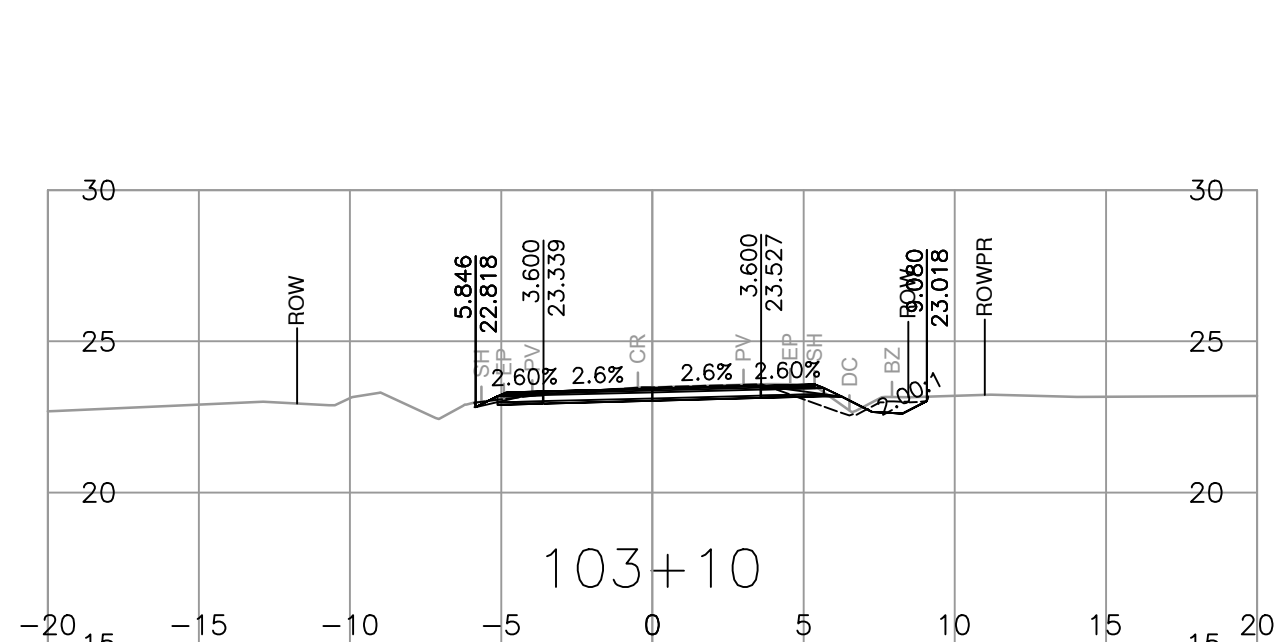
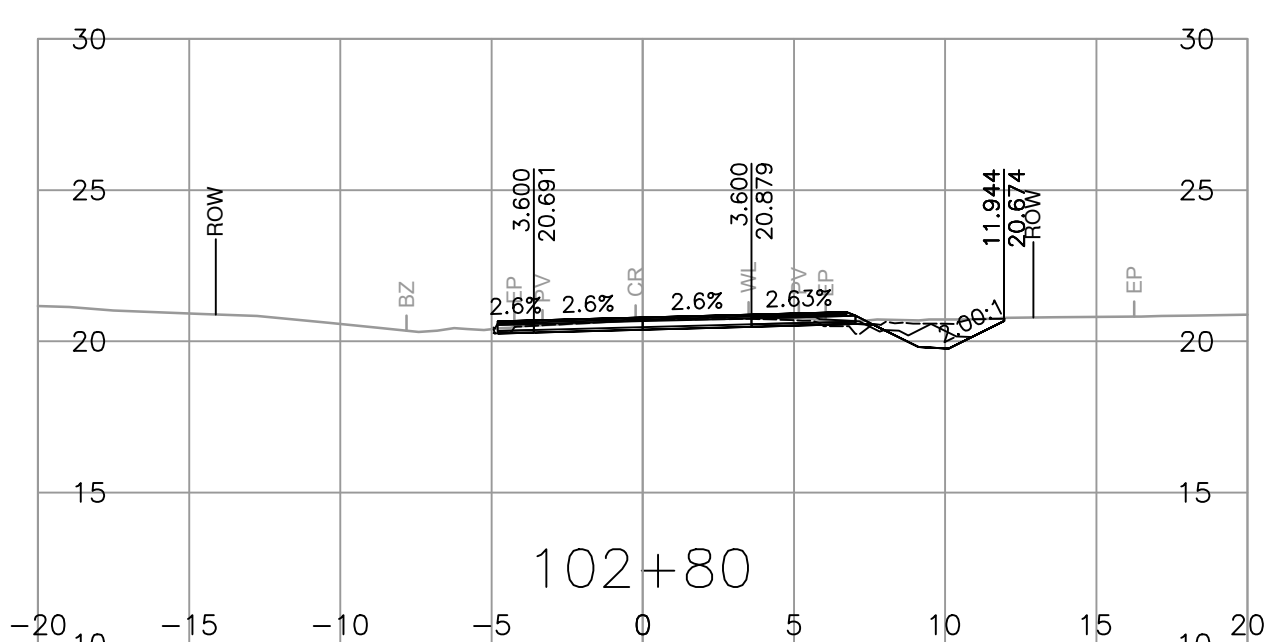
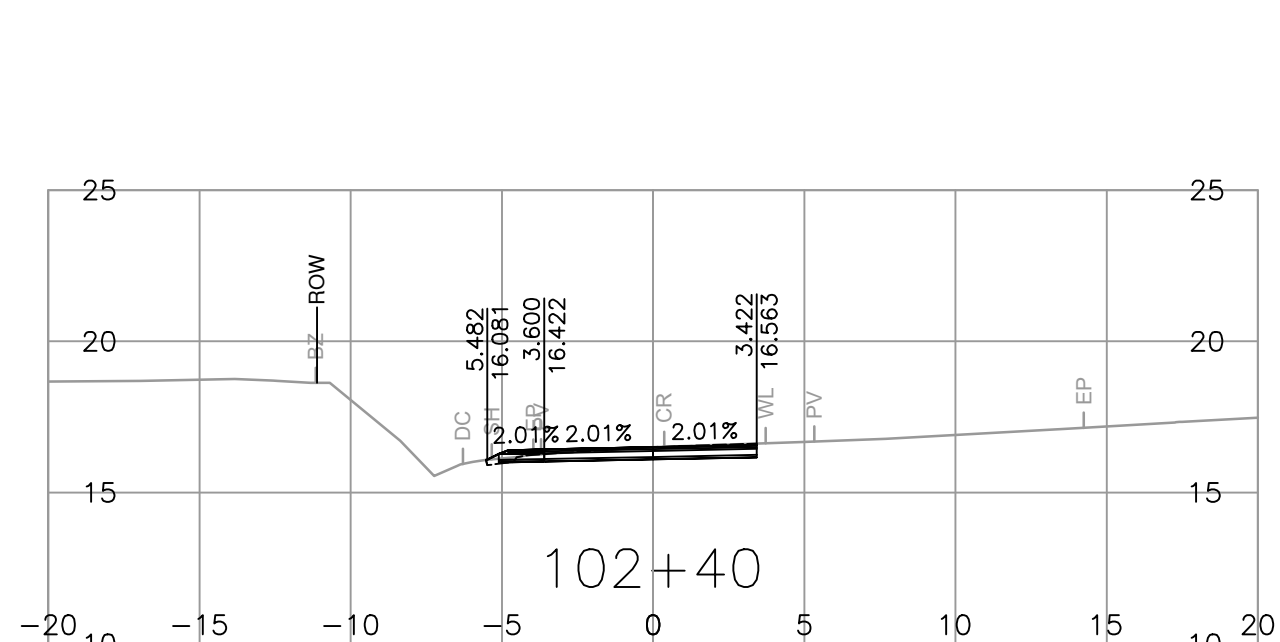
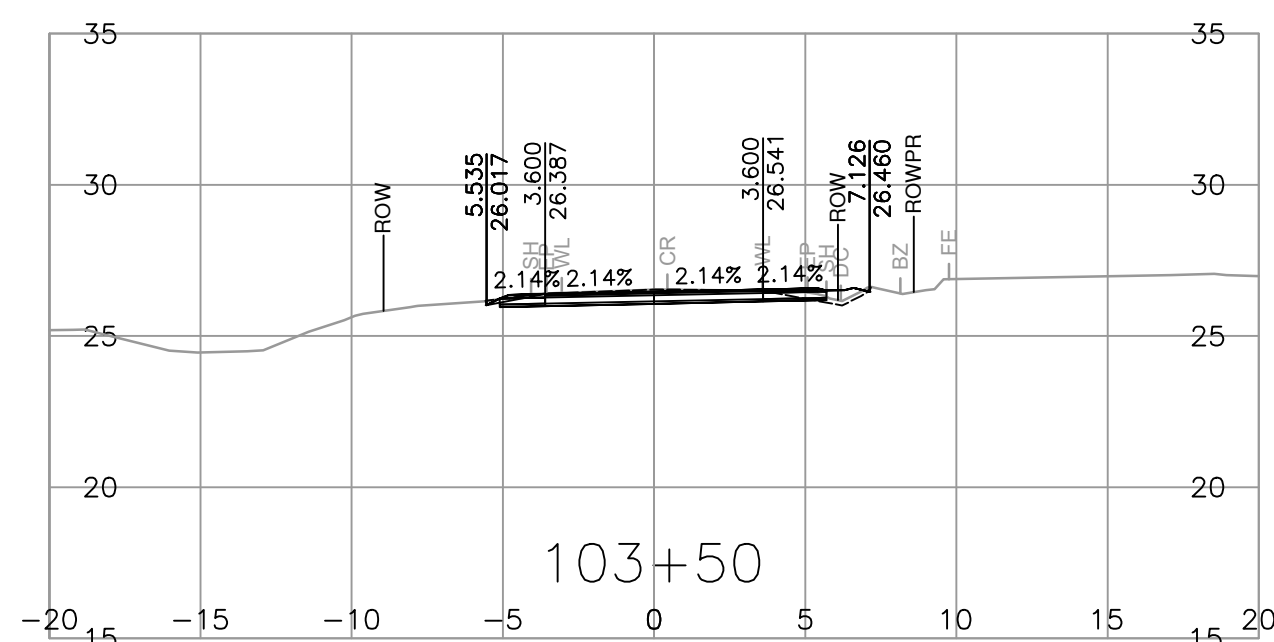
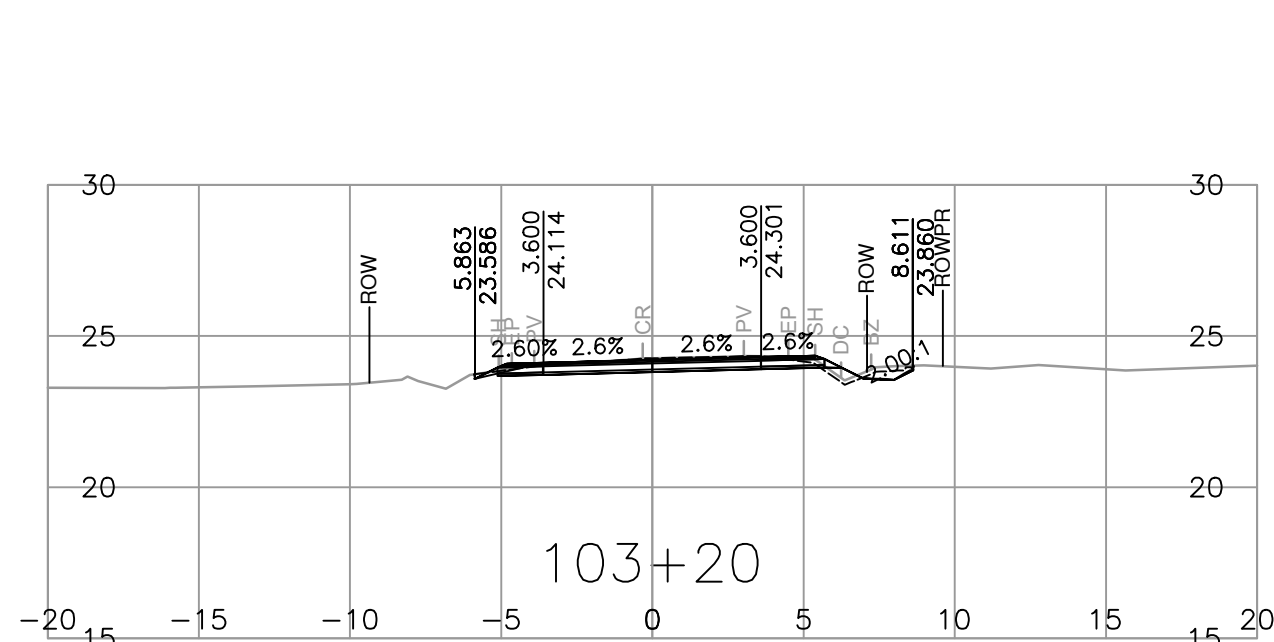
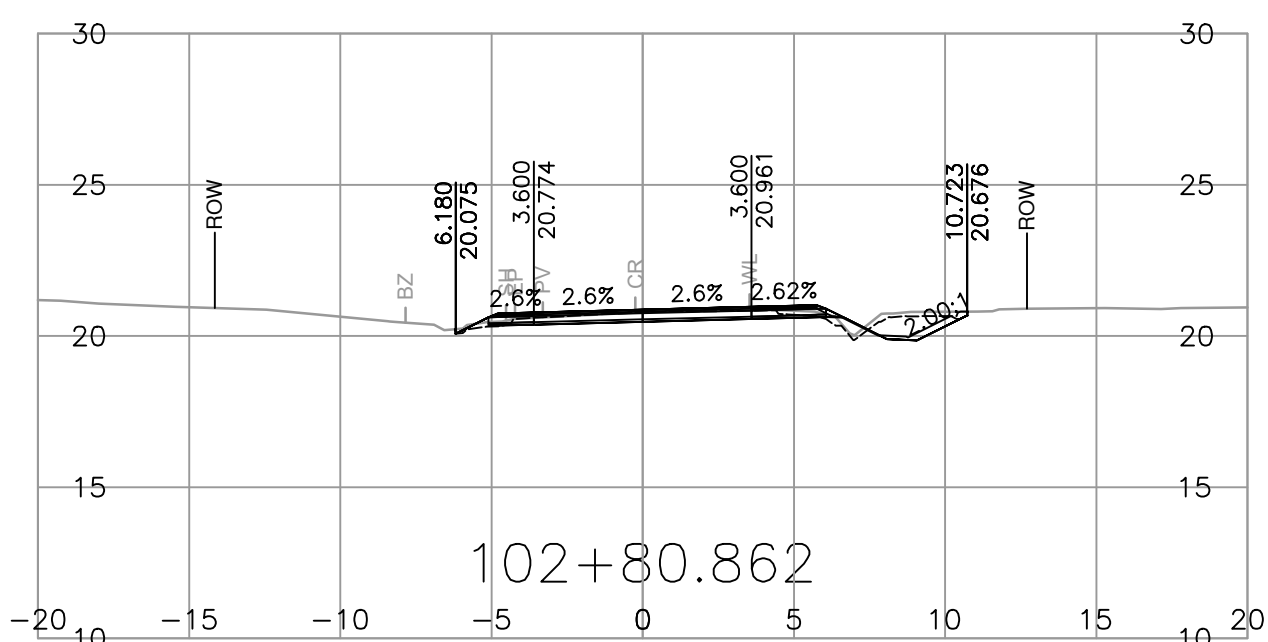
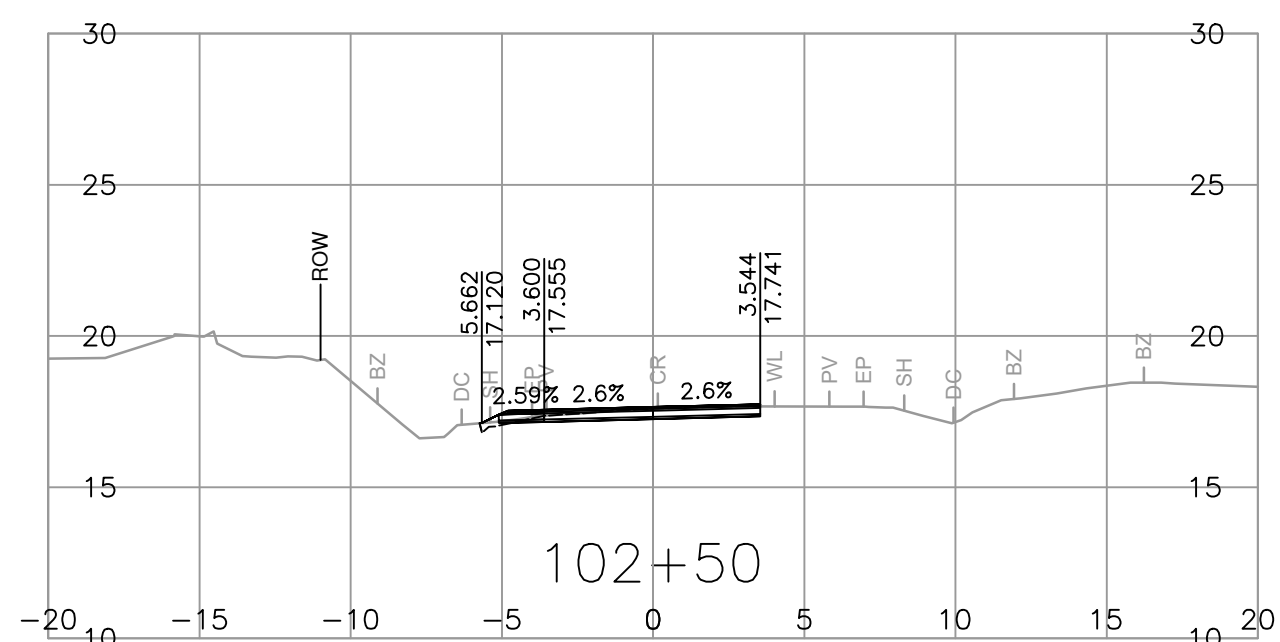
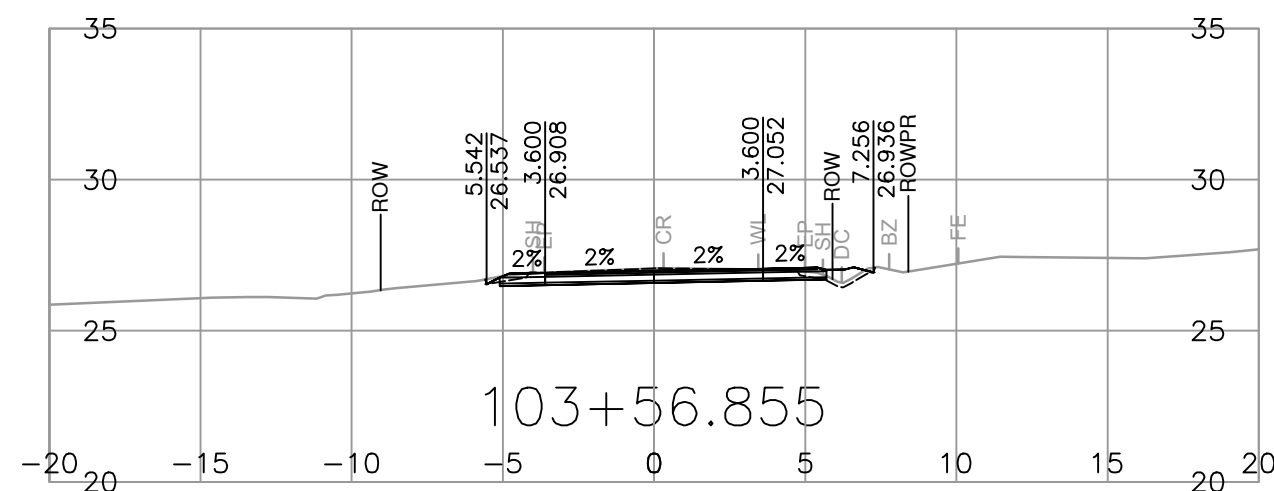
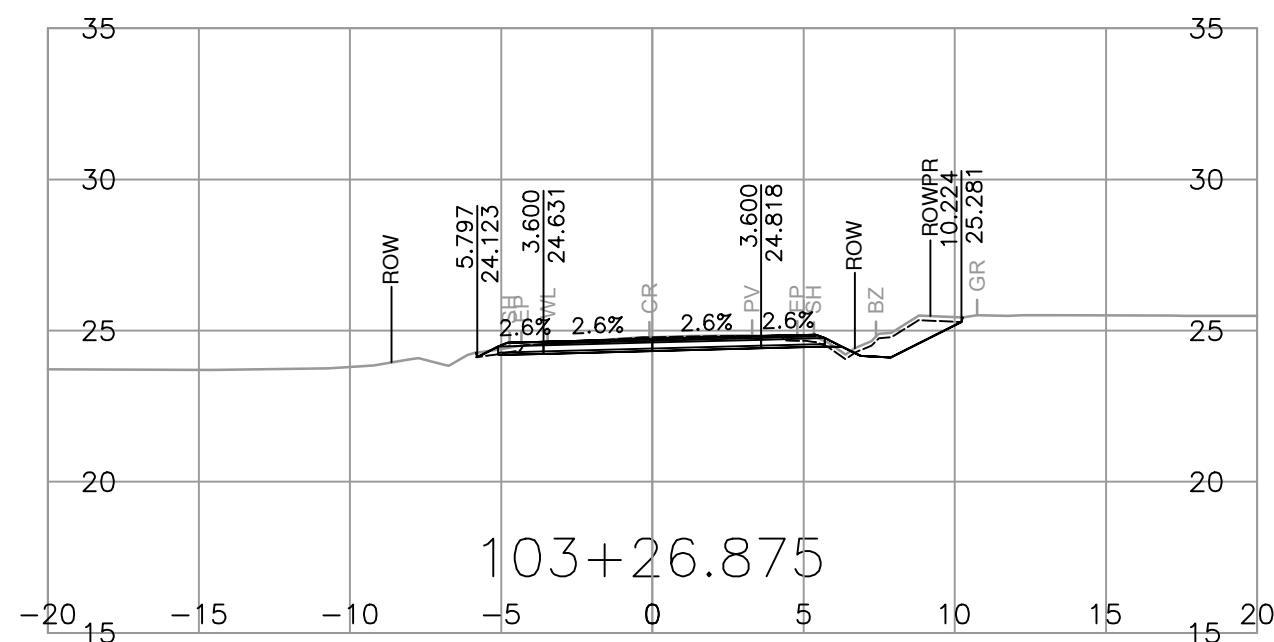
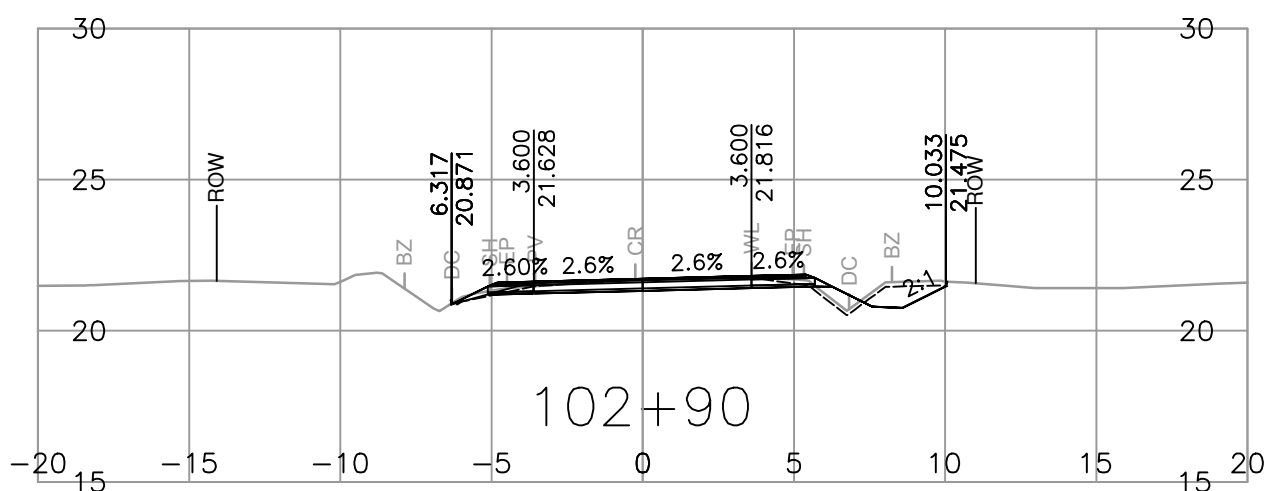
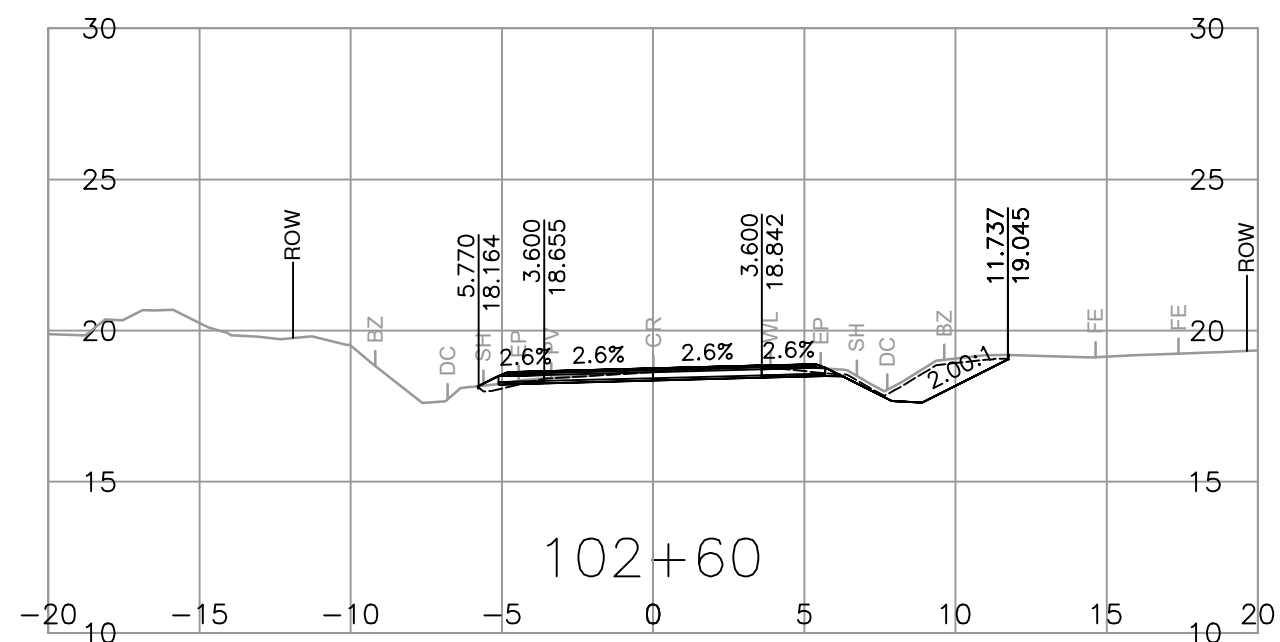
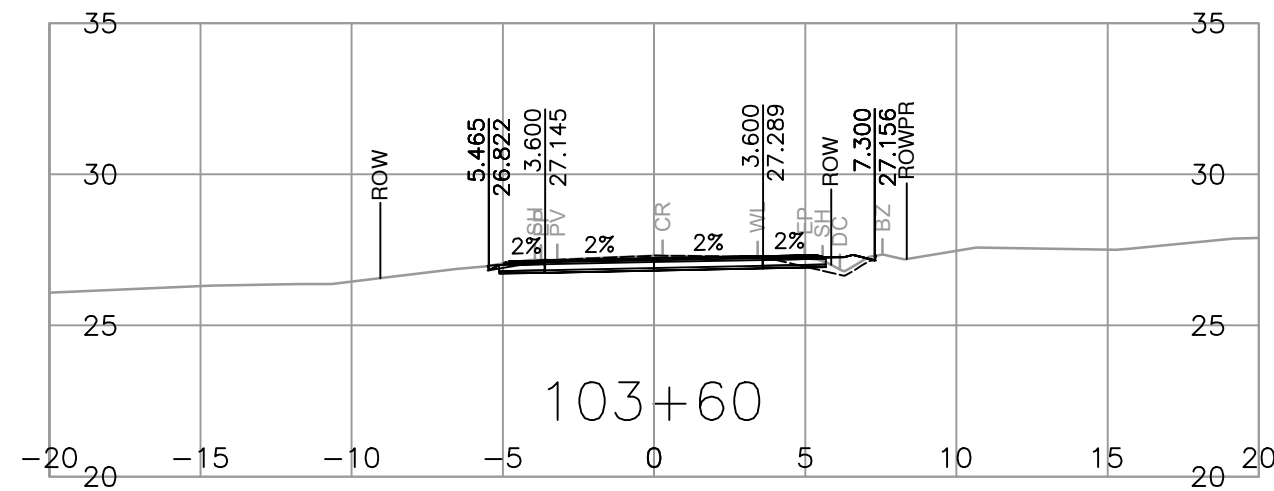
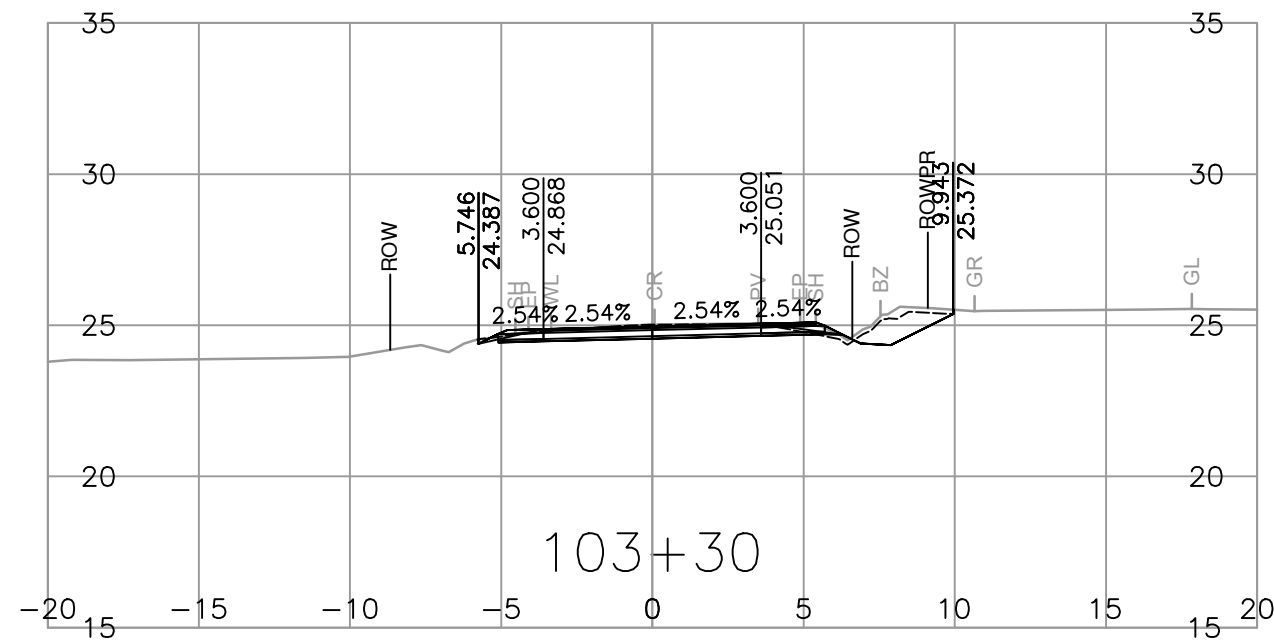
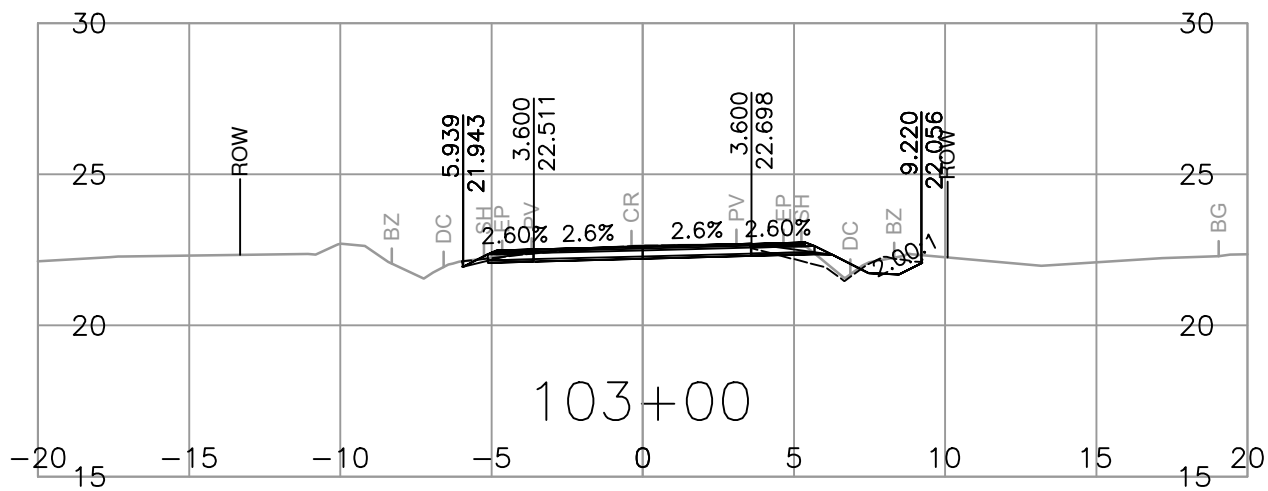
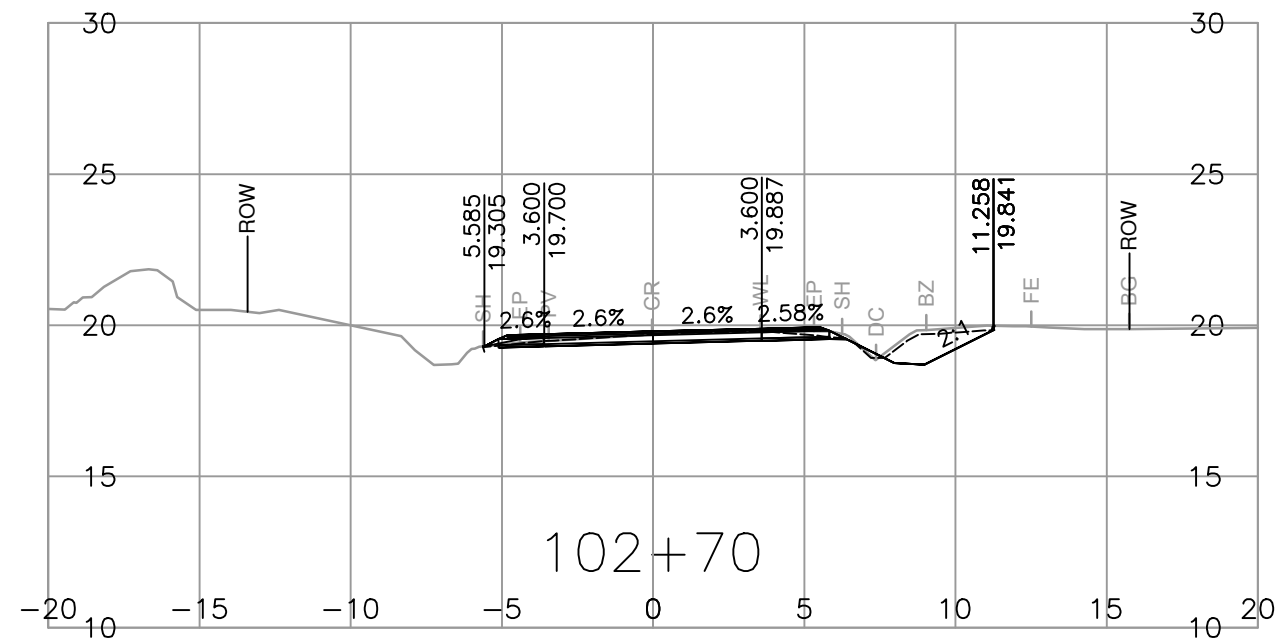

<p>SUITE 201, 8506 - 200 STREET LANGLEY, BRITISH COLUMBIA, V2Y 0M1 PH : 604.371.0091 FAX : 604.371.0098</p>	<p>SCALE 0 2 1:250 12m</p>	<p>CAD FILENAME: R1-989-1000 PLOT DATE: 2024-03-01</p>	<p>MINISTRY OF TRANSPORTATION AND INFRASTRUCTURE SOUTH COAST REGION VANCOUVER ISLAND DISTRICT</p>	<p>DESIGNED: B. PEEBLES DATE: 2024-02-01 QUALITY CONTROL: Z. PENDON DATE: 2024-02-01 QUALITY ASSURANCE: A. SANTOS DATE: 2024-02-01 DRAWN: J. SHIM DATE: 2024-02-01</p>	<p>FILE NUMBER: 32836 PROJECT NUMBER: 16873-0001 REG: 1 DRAWING NUMBER: R1-989-1002 REV: PD</p>																	
	<table border="1"> <thead> <tr> <th>REV</th> <th>DATE</th> <th>REVISIONS</th> <th>NAME</th> </tr> </thead> <tbody> <tr> <td>PA</td> <td>2021-06-14</td> <td>REVISED 70% DETAILED DESIGN</td> <td>Z. PENDON</td> </tr> <tr> <td>PB</td> <td>2022-06-30</td> <td>100% FUNCTIONAL DESIGN</td> <td>Z. PENDON</td> </tr> <tr> <td>PC</td> <td>2022-10-07</td> <td>75% DETAILED DESIGN</td> <td>Z. PENDON</td> </tr> <tr> <td>PD</td> <td>2023-06-08</td> <td>90% DETAILED DESIGN</td> <td>Z. PENDON</td> </tr> </tbody> </table>	REV	DATE	REVISIONS	NAME	PA	2021-06-14	REVISED 70% DETAILED DESIGN	Z. PENDON	PB	2022-06-30	100% FUNCTIONAL DESIGN	Z. PENDON	PC	2022-10-07	75% DETAILED DESIGN	Z. PENDON	PD	2023-06-08	90% DETAILED DESIGN	Z. PENDON	<p>SENIOR DESIGNER: _____ DATE: _____</p>
REV	DATE	REVISIONS	NAME																			
PA	2021-06-14	REVISED 70% DETAILED DESIGN	Z. PENDON																			
PB	2022-06-30	100% FUNCTIONAL DESIGN	Z. PENDON																			
PC	2022-10-07	75% DETAILED DESIGN	Z. PENDON																			
PD	2023-06-08	90% DETAILED DESIGN	Z. PENDON																			

PLOT DATE: 2024/03/01 G:\Projects\32000\32836_MoTI_Fulford_Ganges_Road_Widening\02_CADD\DrawingProduction\1000_DesignSections\R1-989-1000.dwg

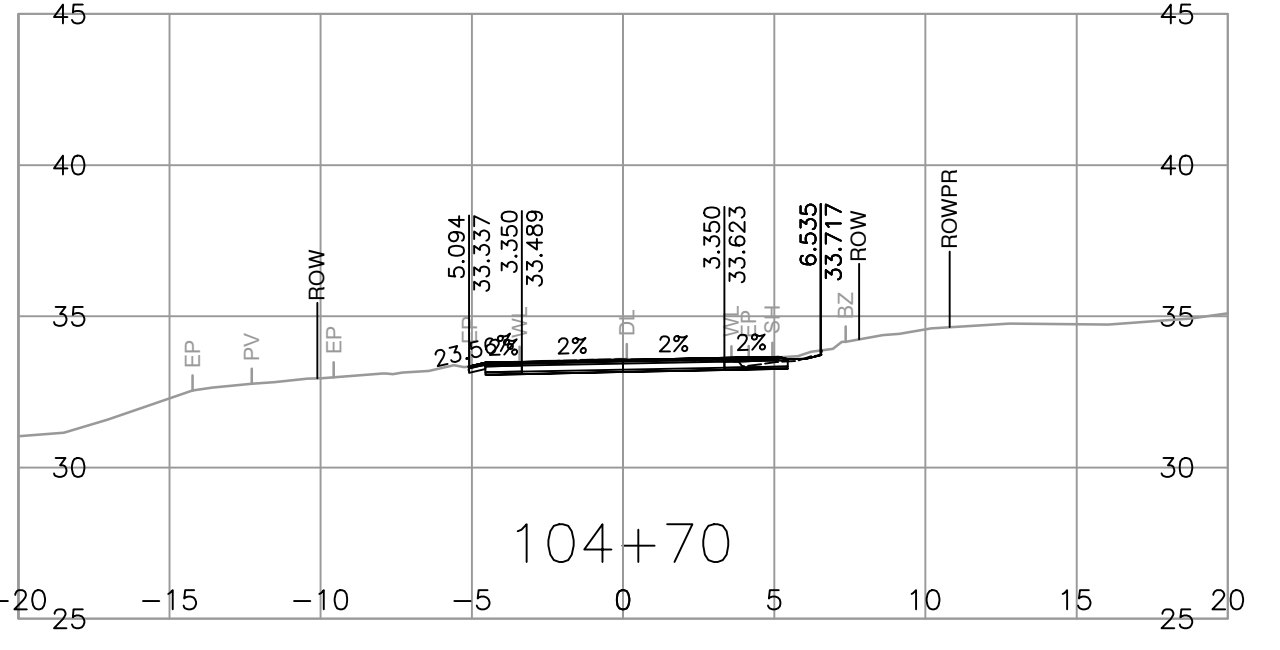
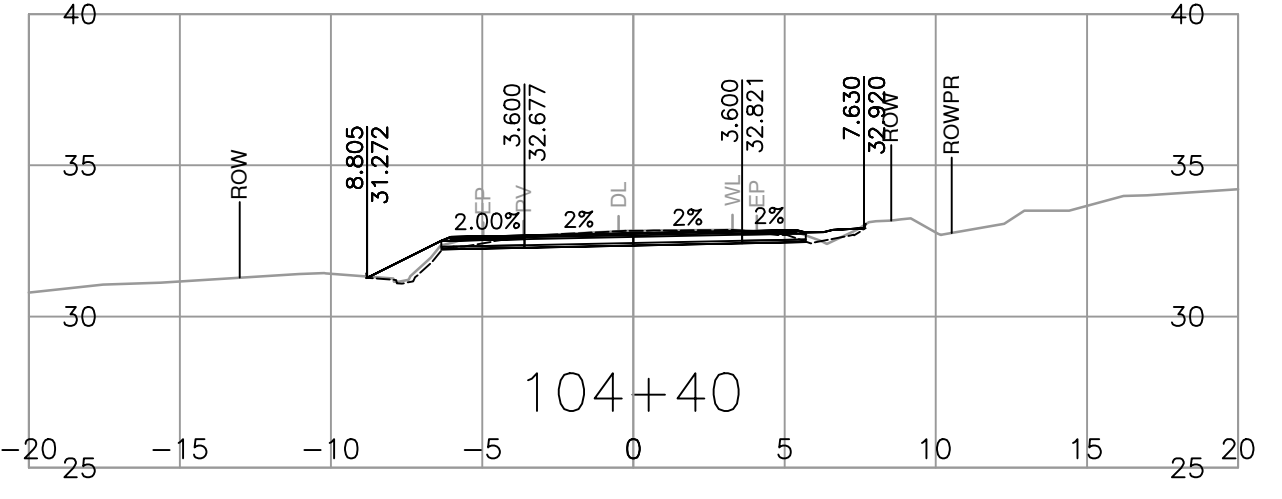
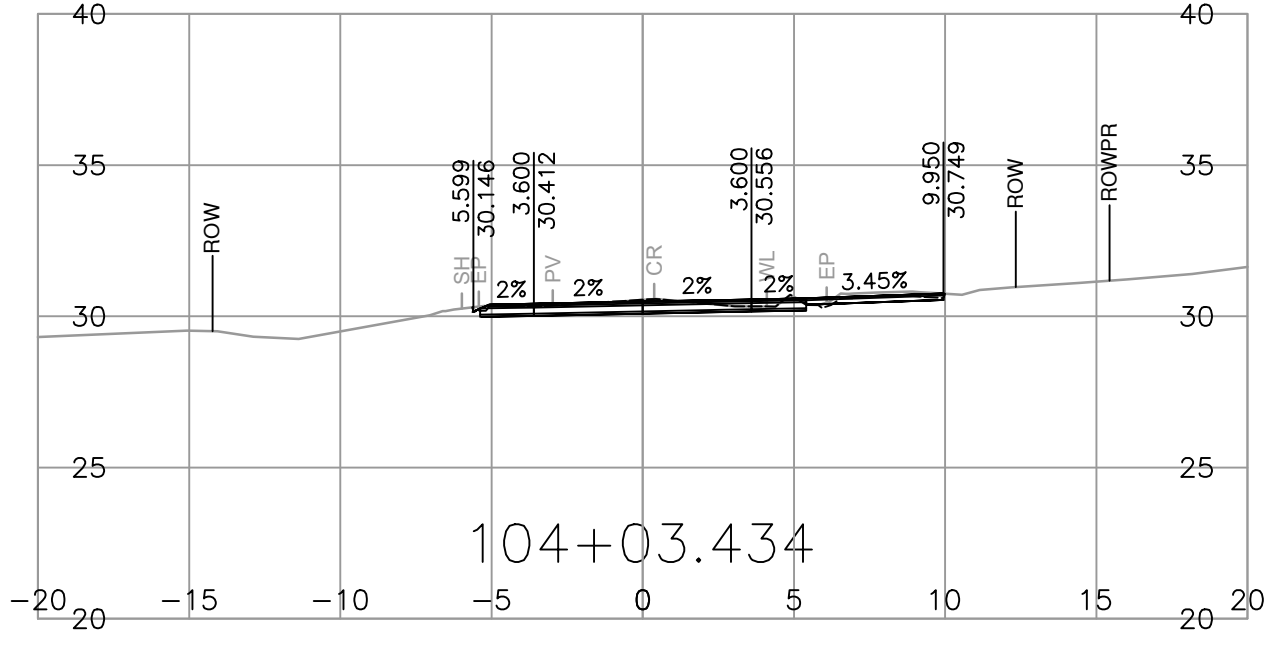
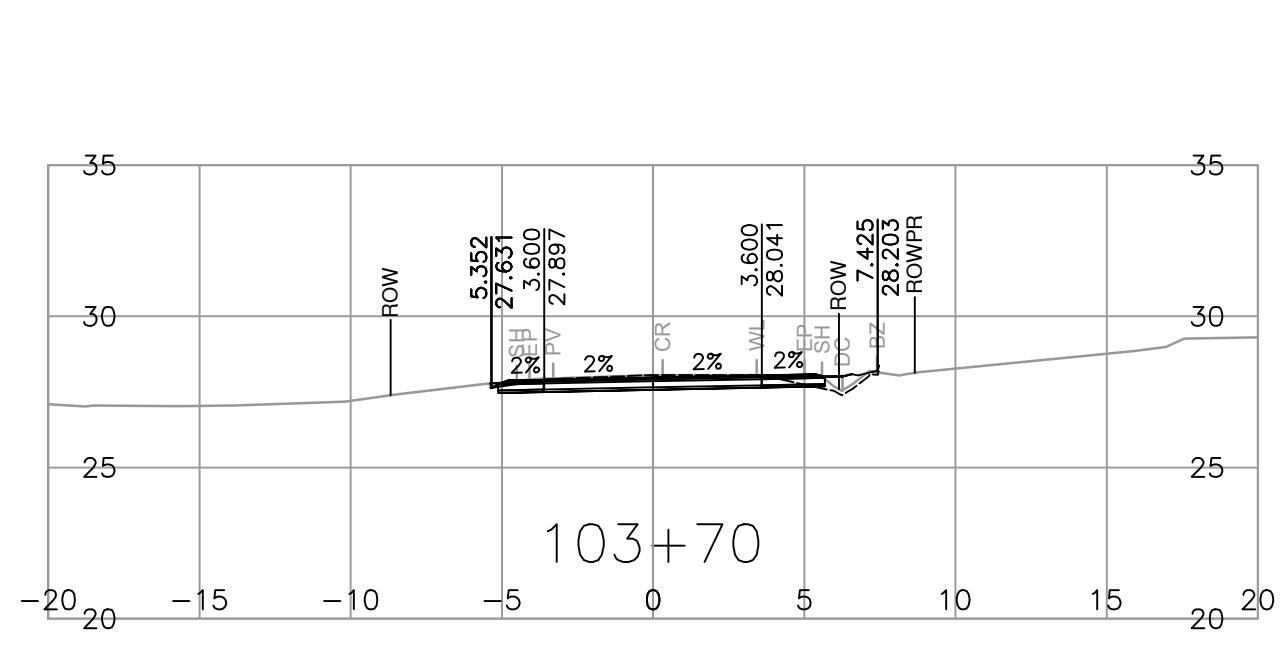
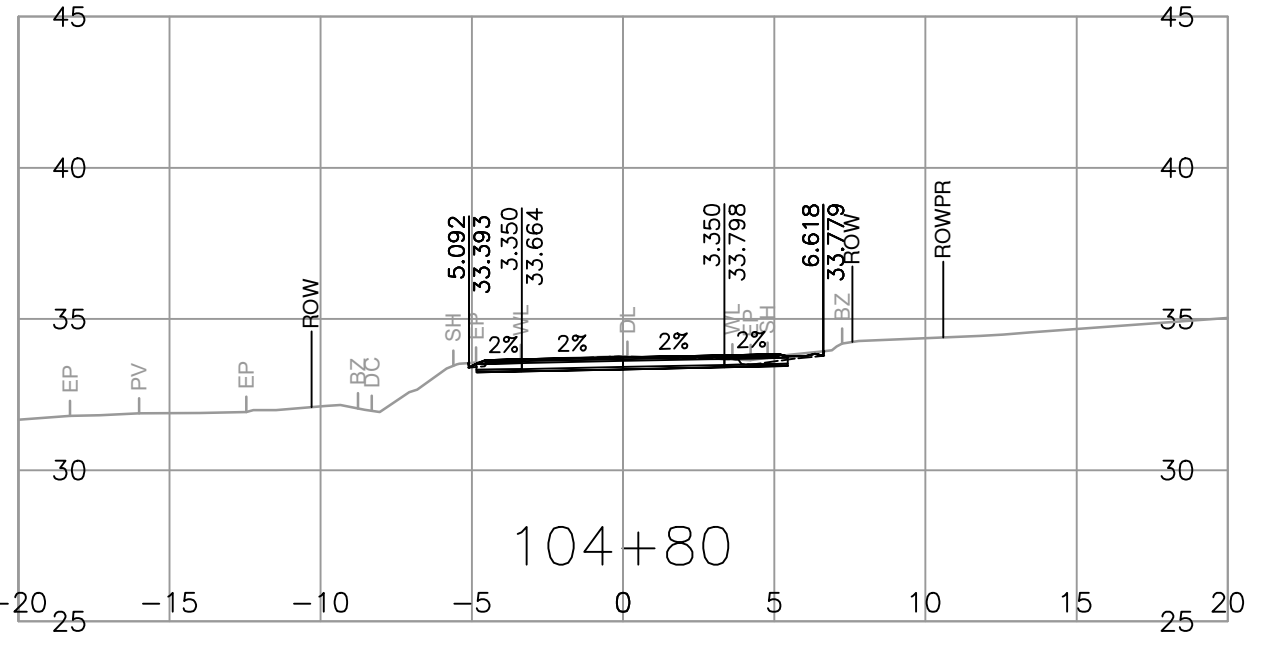
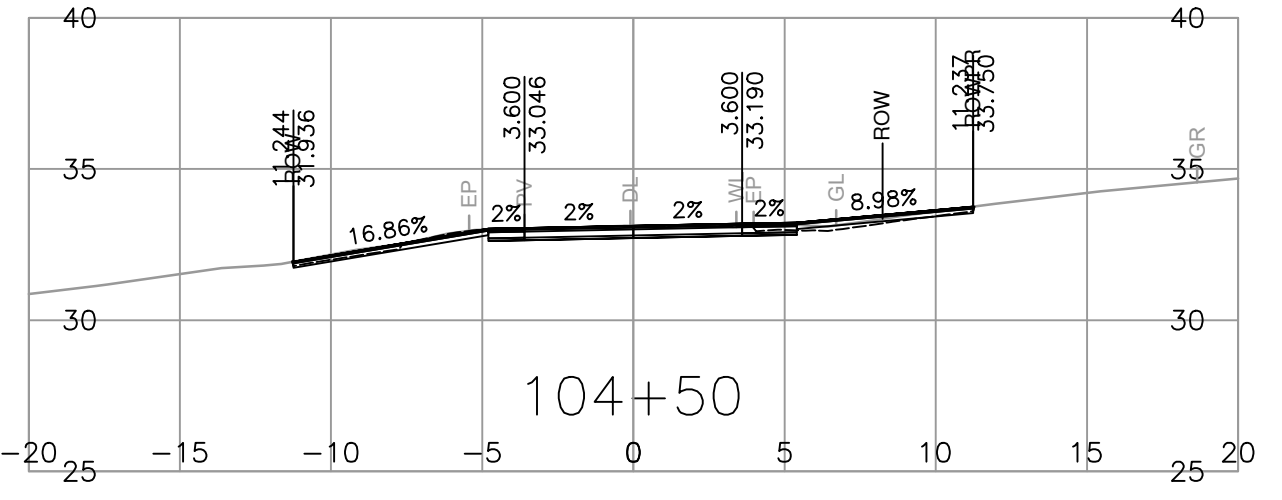
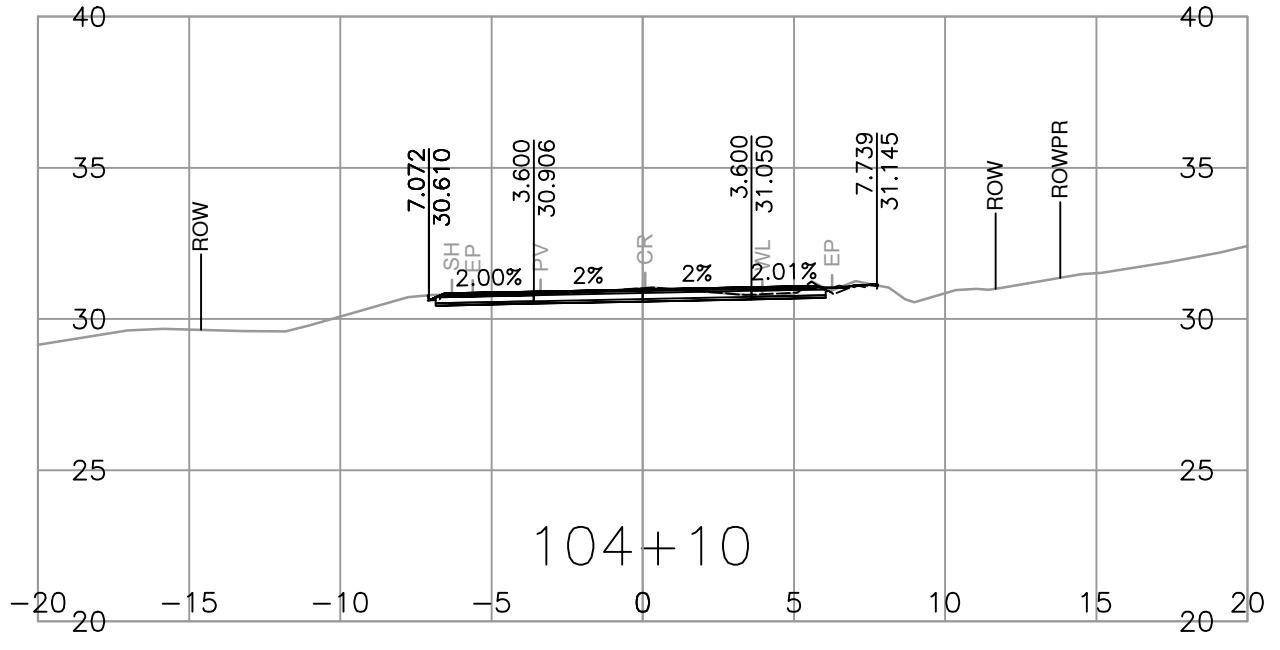
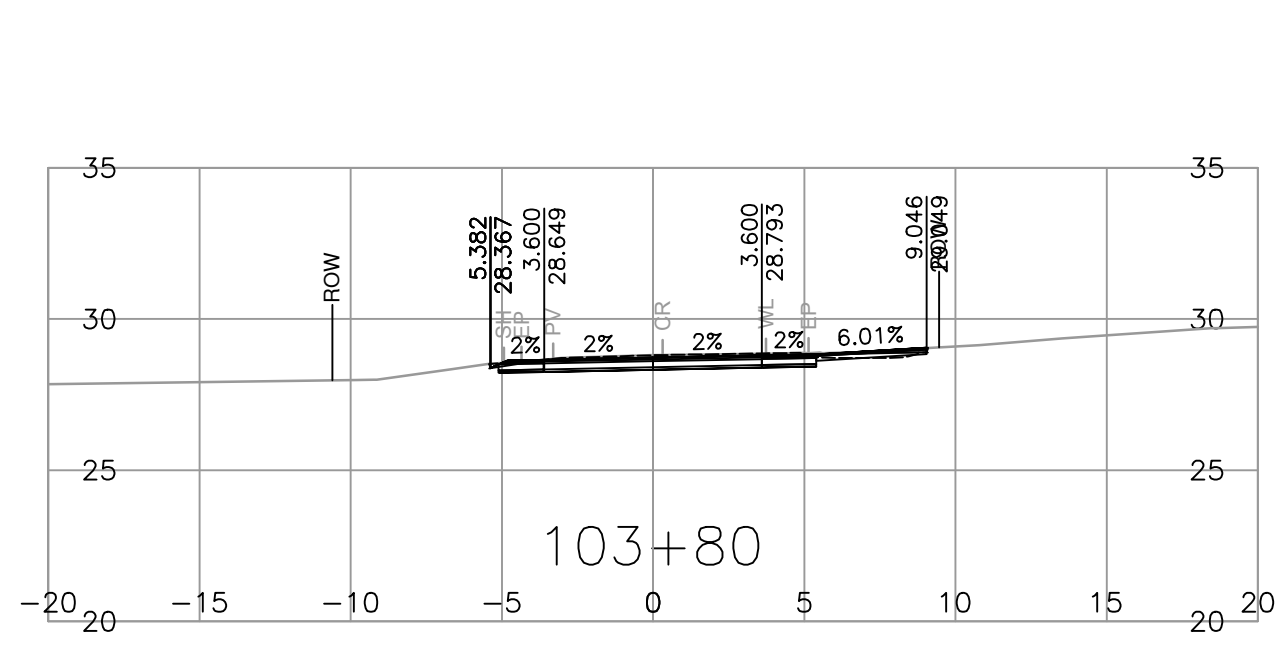
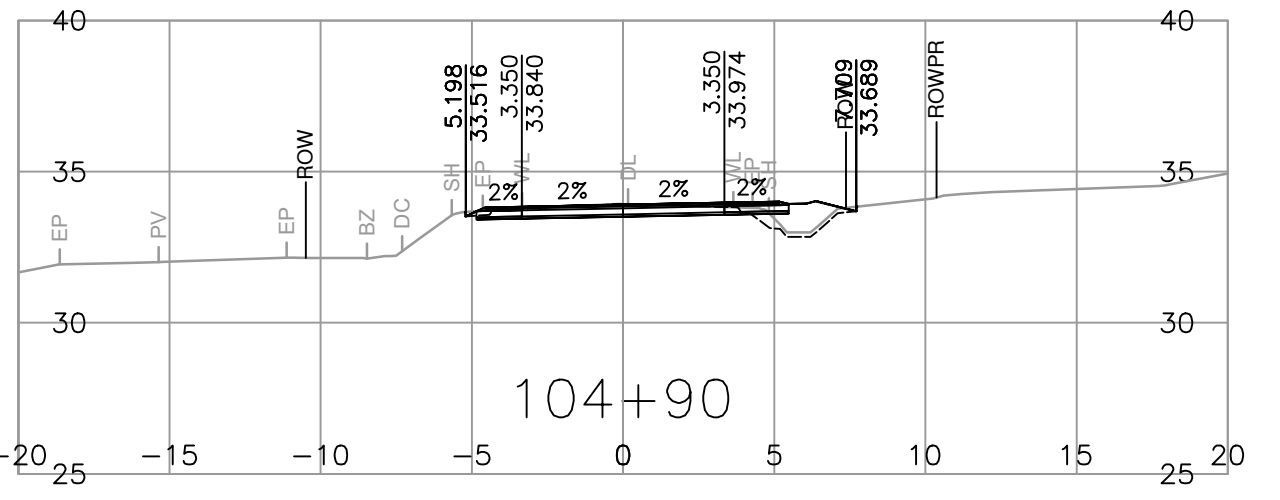
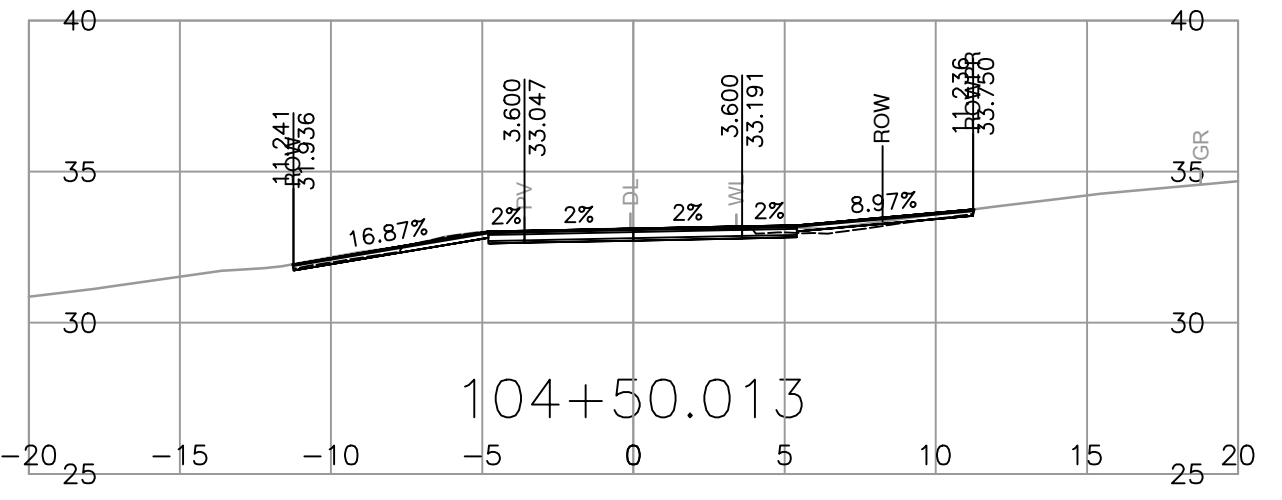
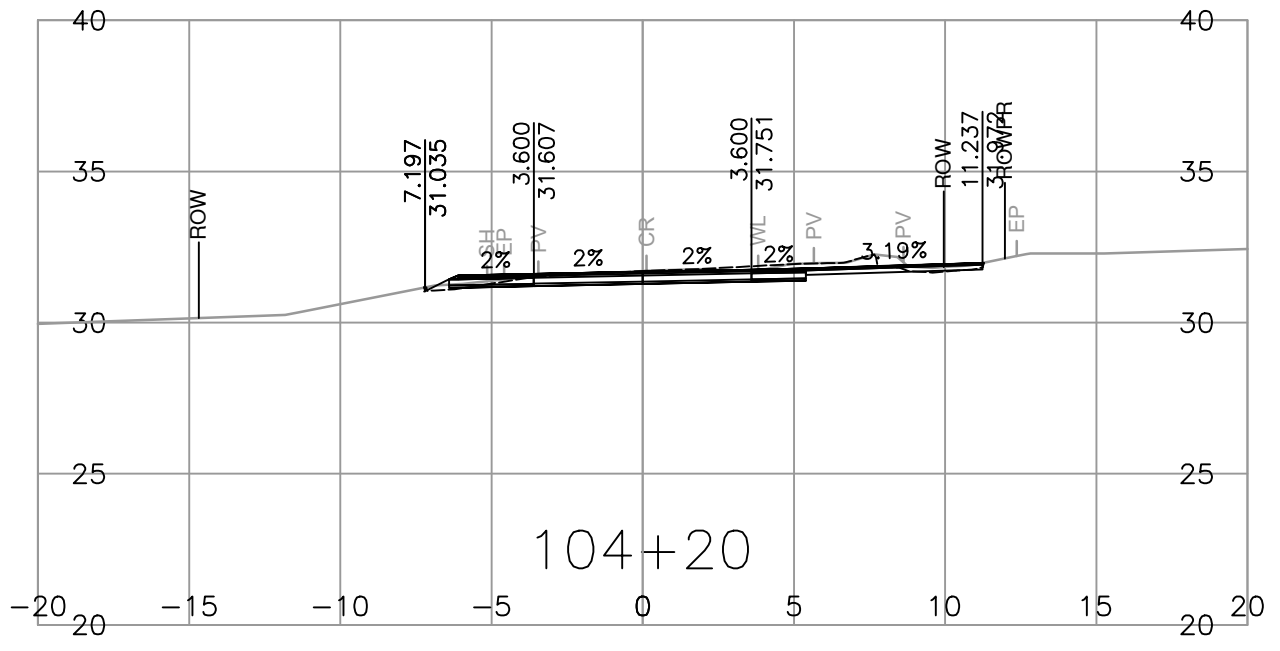
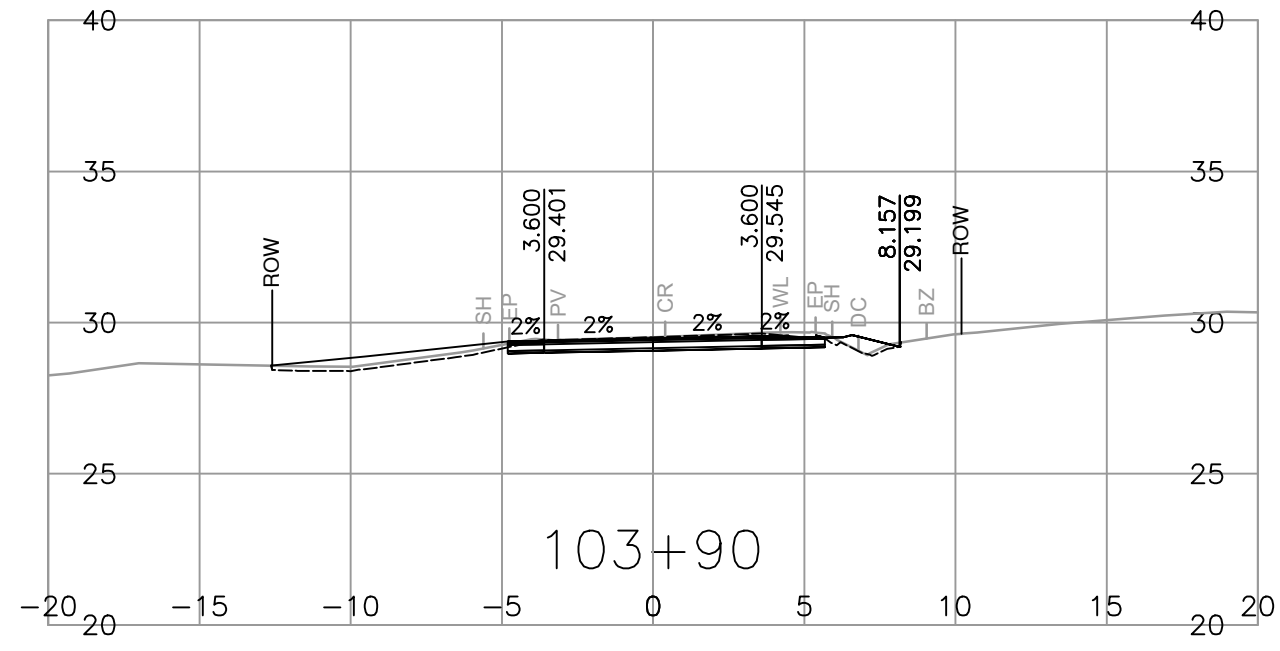
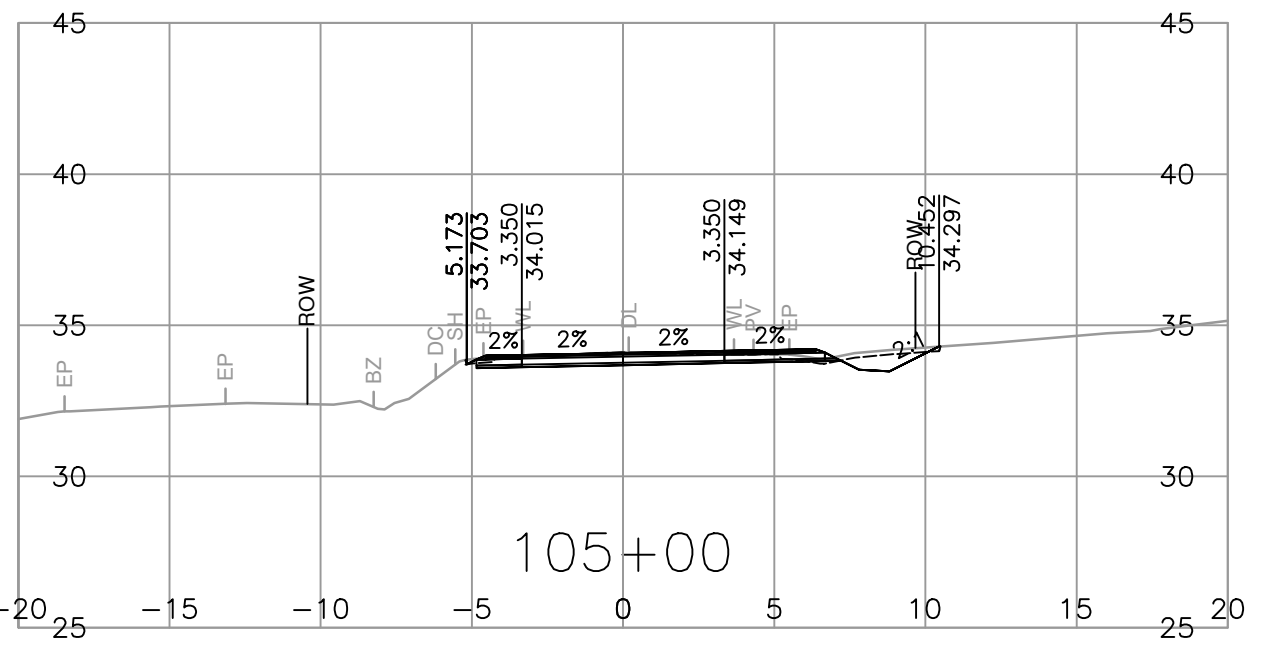
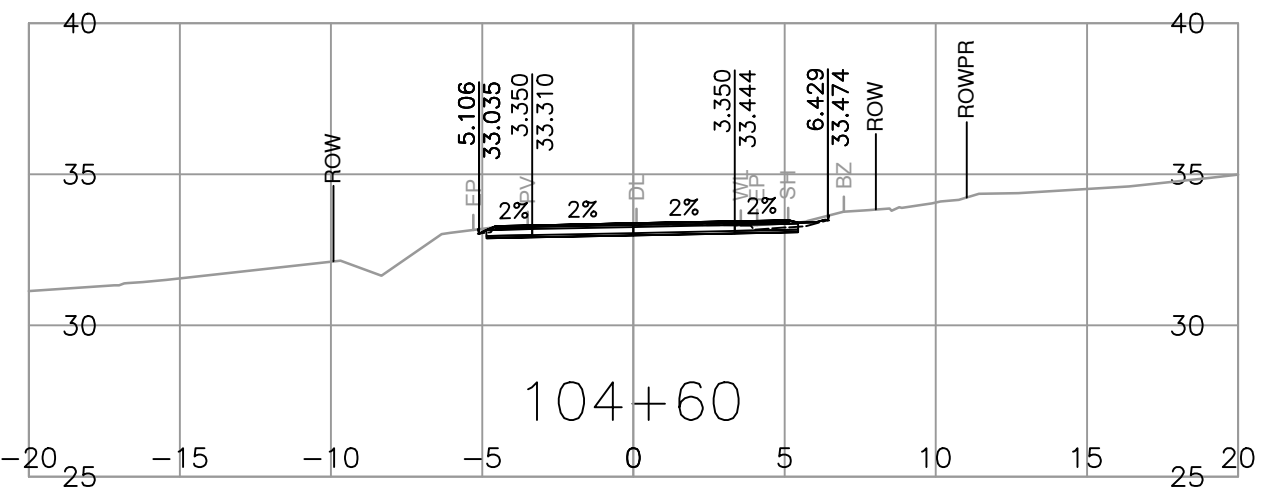
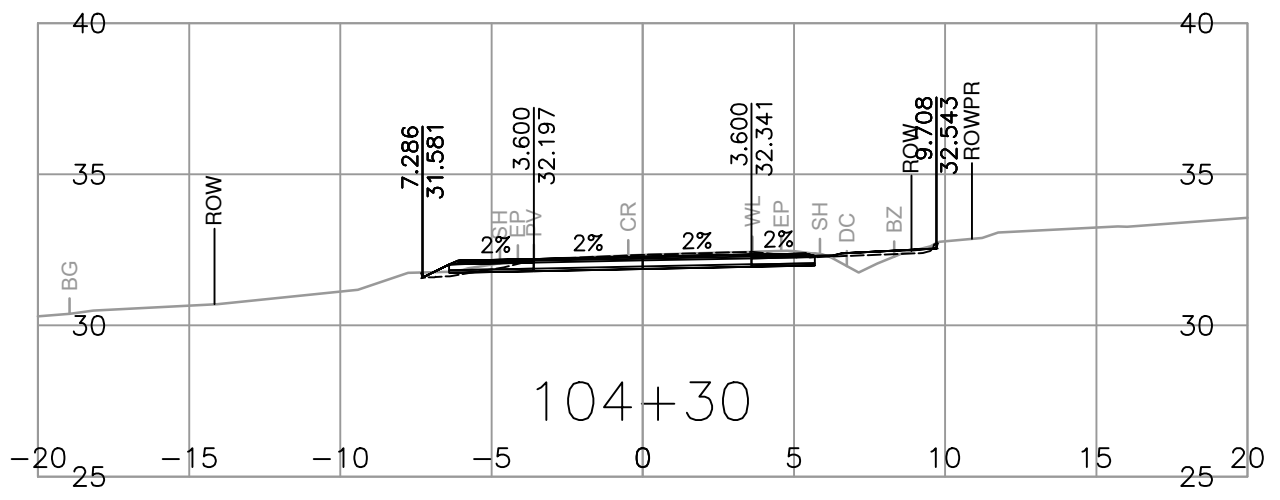
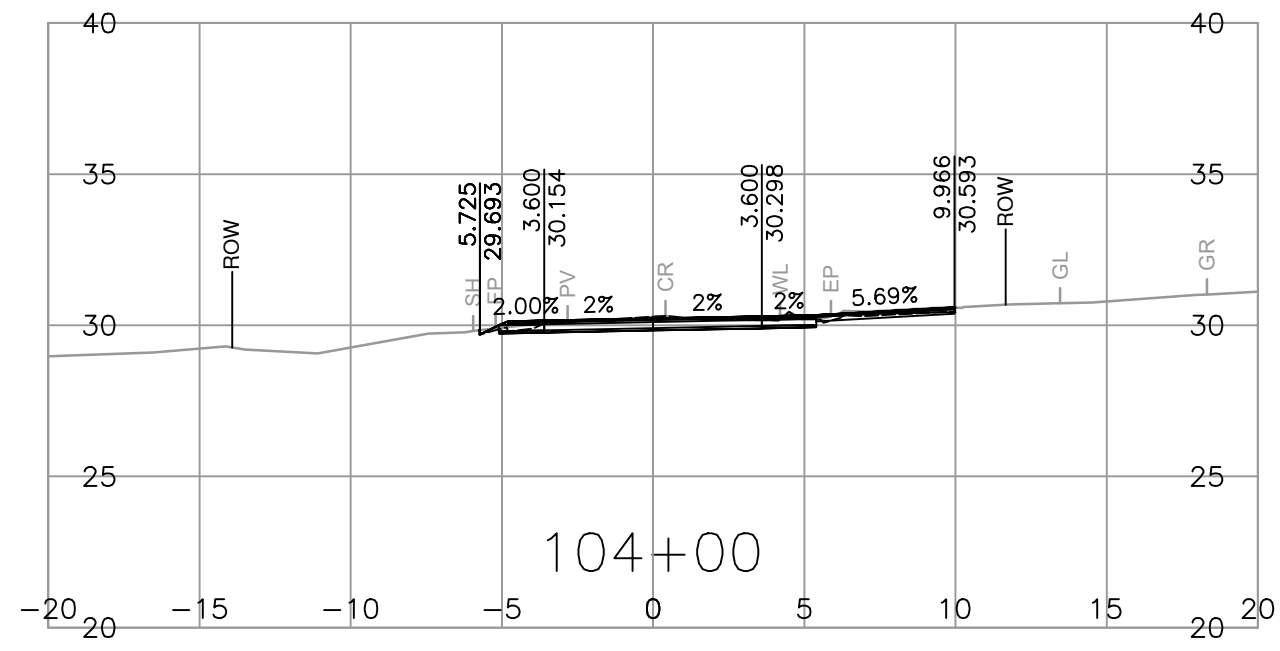

<p>SUITE 201, 8506 - 200 STREET LANGLEY, BRITISH COLUMBIA, V2Y 0M1 PH : 604.371.0091 FAX : 604.371.0098</p>	<p>SCALE: 0 2 1:250 12m</p>	<p>CAD FILENAME: R1-989-1000 PLOT DATE: 2024-03-01</p>	<p>MINISTRY OF TRANSPORTATION AND INFRASTRUCTURE SOUTH COAST REGION VANCOUVER ISLAND DISTRICT</p>	<p>DESIGNED: B. PEEBLES DATE: 2024-02-01 QUALITY CONTROL: Z. PENDON DATE: 2024-02-01 QUALITY ASSURANCE: A. SANTOS DATE: 2024-02-01 DRAWN: J. SHIM DATE: 2024-02-01</p>	<p>FILE NUMBER: 32836 PROJECT NUMBER: 16873-0001 REG: 1 DRAWING NUMBER: R1-989-1003</p>														
	<table border="1"> <thead> <tr> <th>REV</th> <th>DATE</th> <th>REVISIONS</th> <th>NAME</th> </tr> </thead> <tbody> <tr><td> </td><td> </td><td> </td><td> </td></tr> <tr><td> </td><td> </td><td> </td><td> </td></tr> <tr><td> </td><td> </td><td> </td><td> </td></tr> </tbody> </table>	REV	DATE	REVISIONS	NAME													<p>SENIOR DESIGNER: _____ DATE: _____</p>	<p>L100</p>
REV	DATE	REVISIONS	NAME																

PLOT DATE: 2024/03/01 G:\Projects\32000\32836_MoTI_Fulford_Ganges_Road_Widening\02_CADD\DrawingProduction\1000_DesignSections\R1-989-1000.dwg

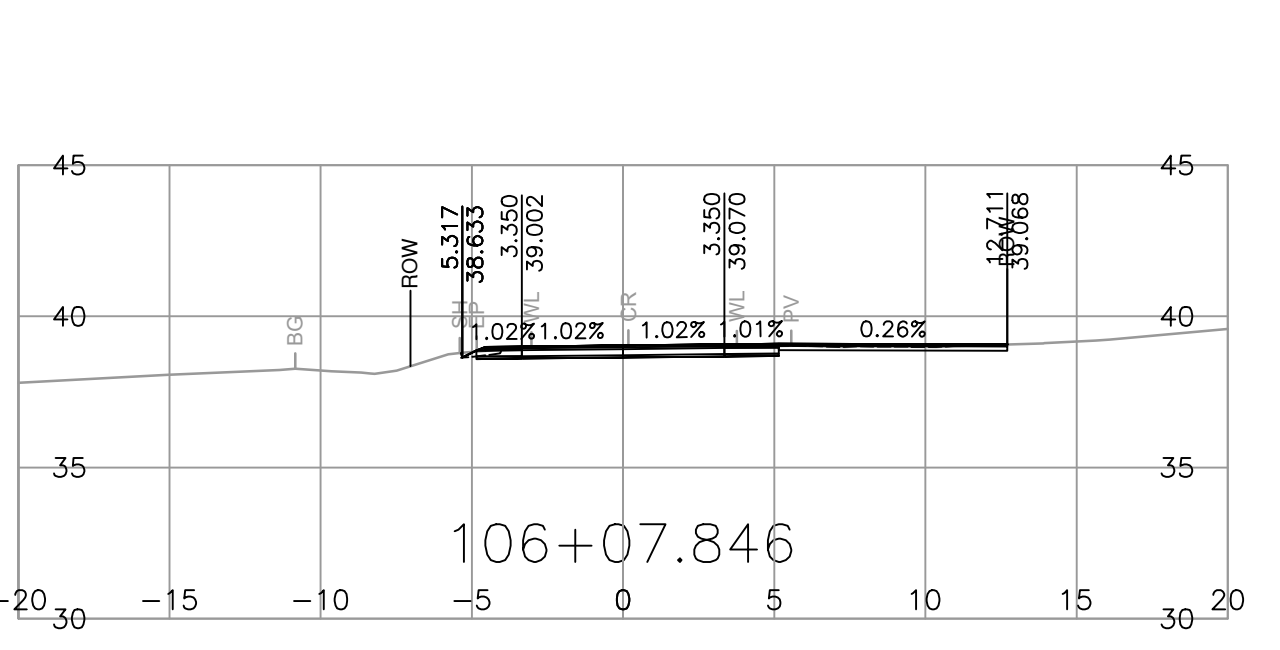
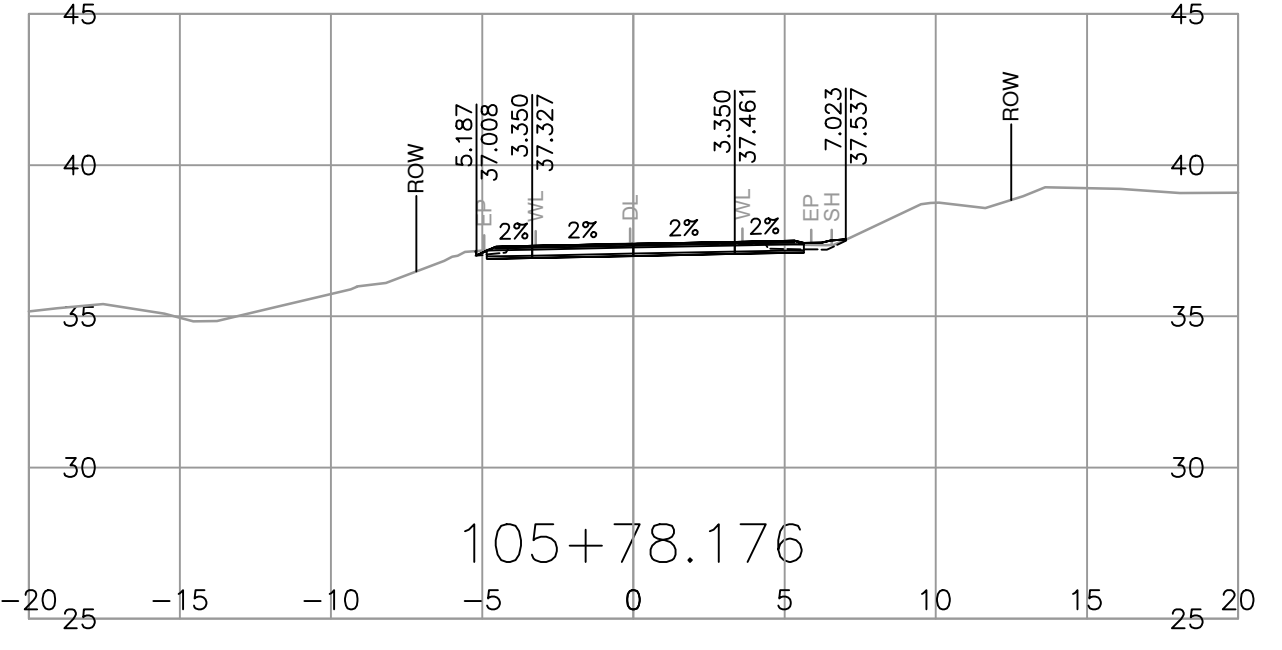
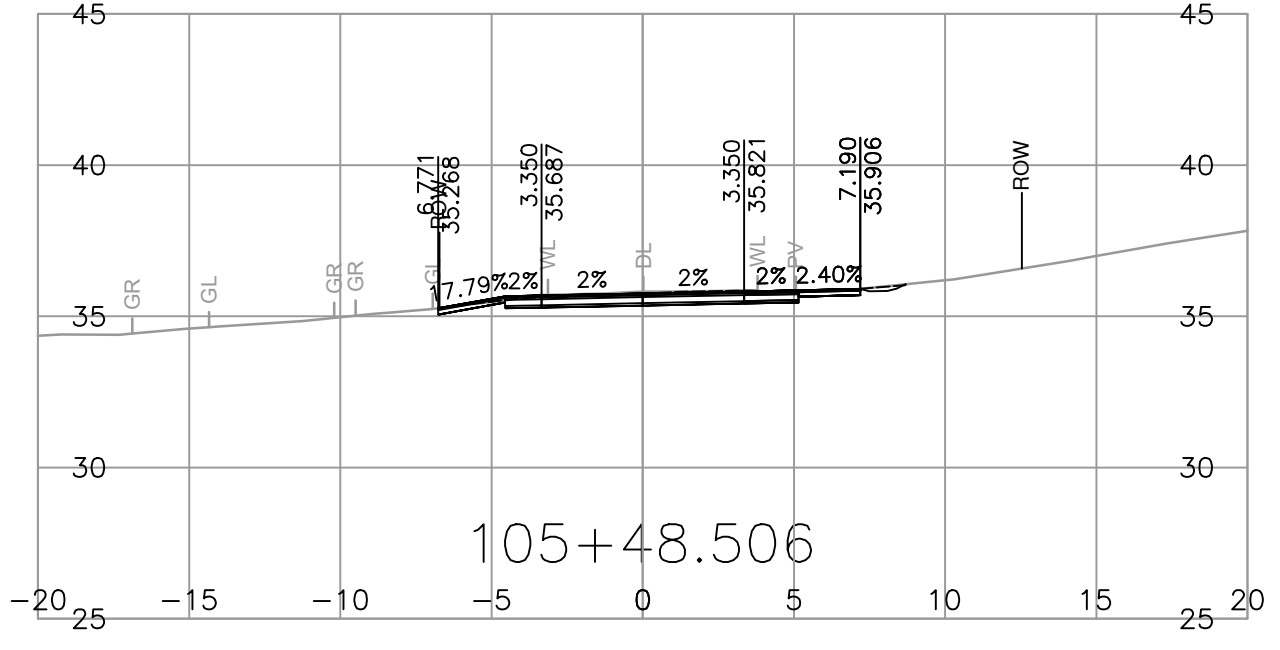
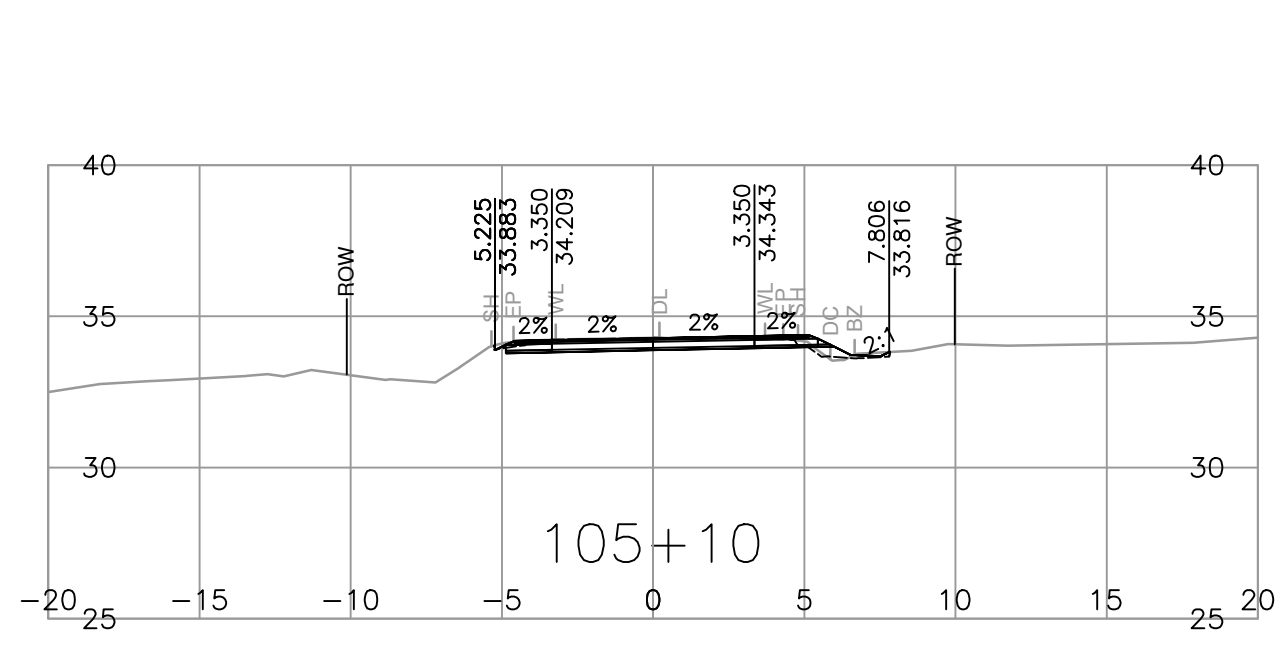
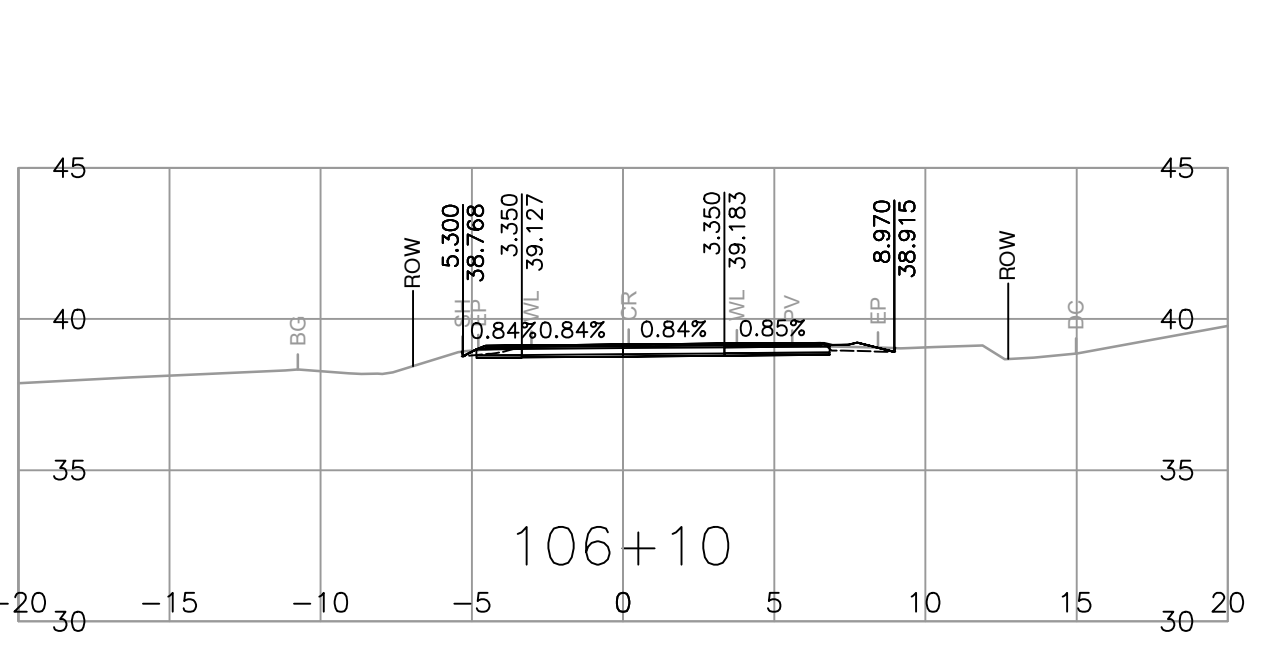
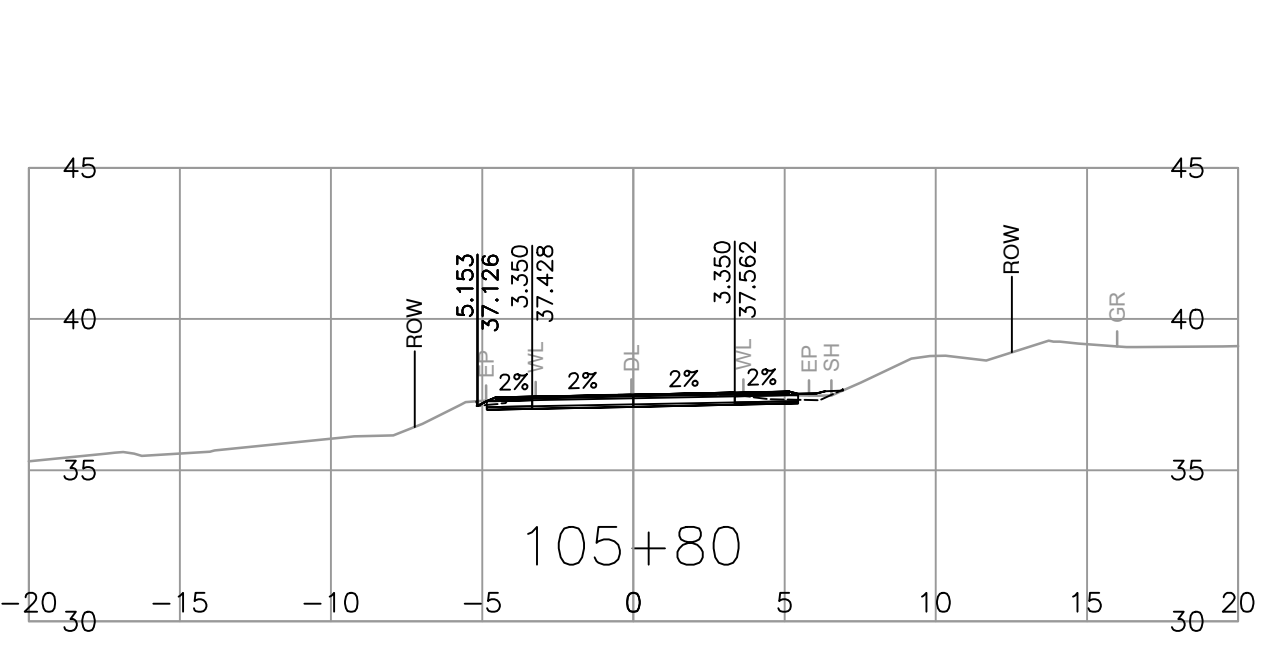
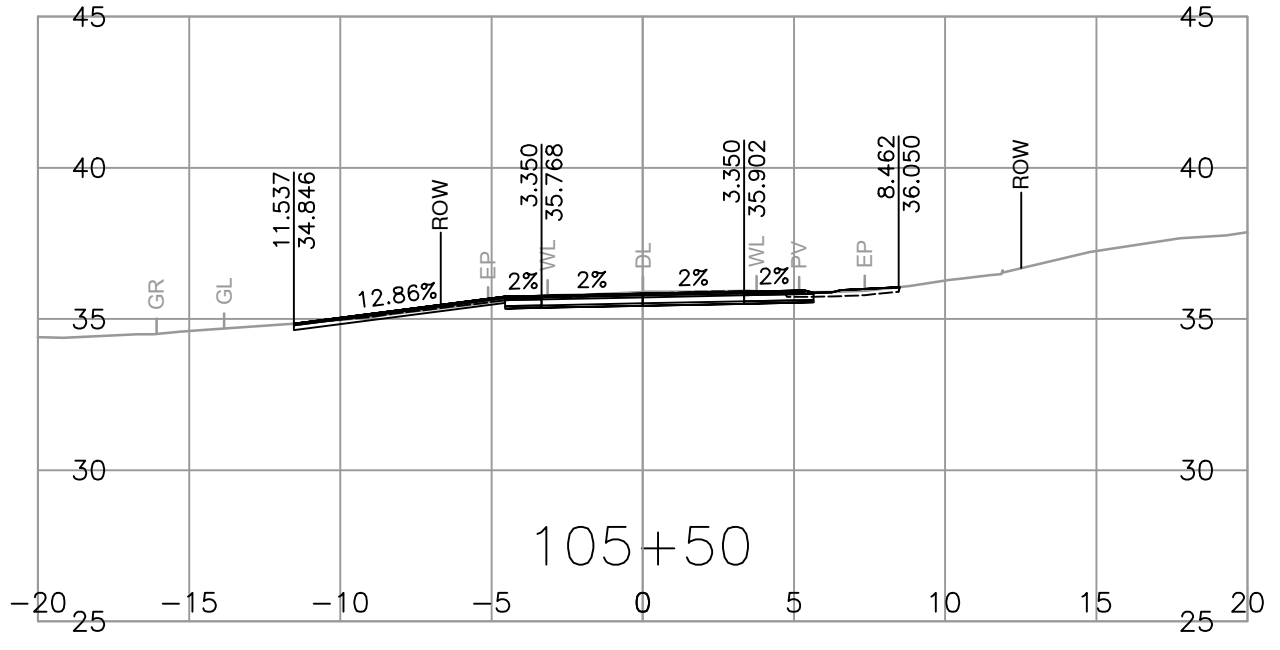
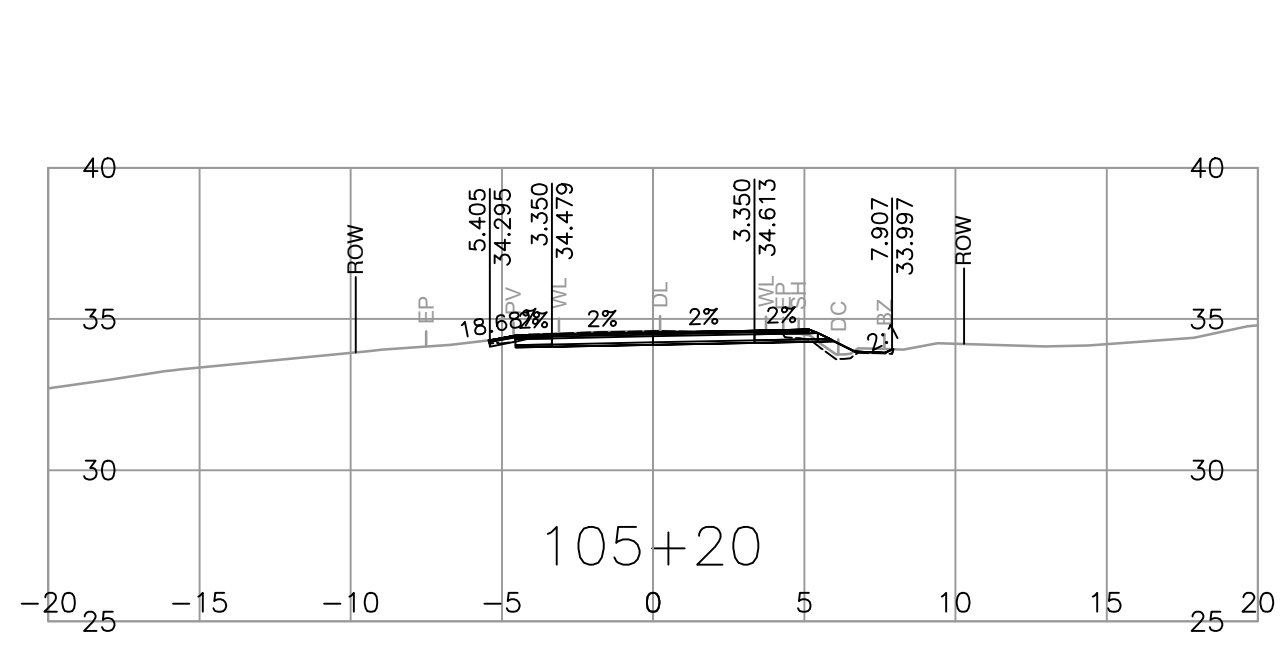
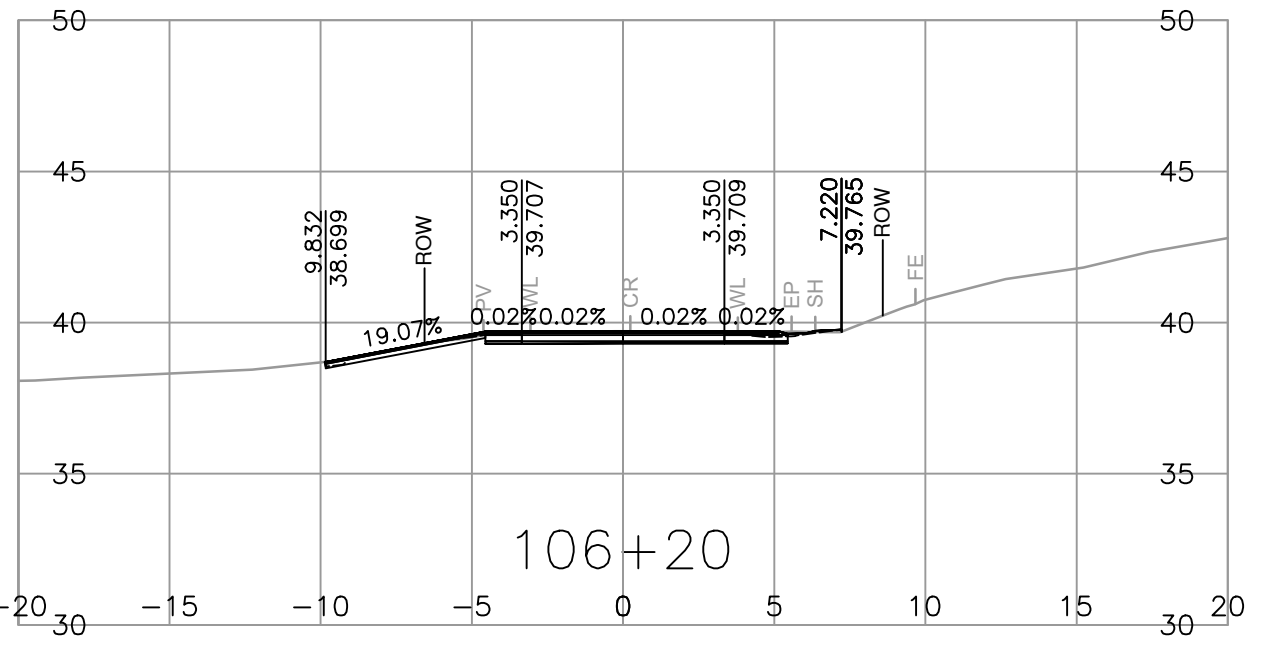
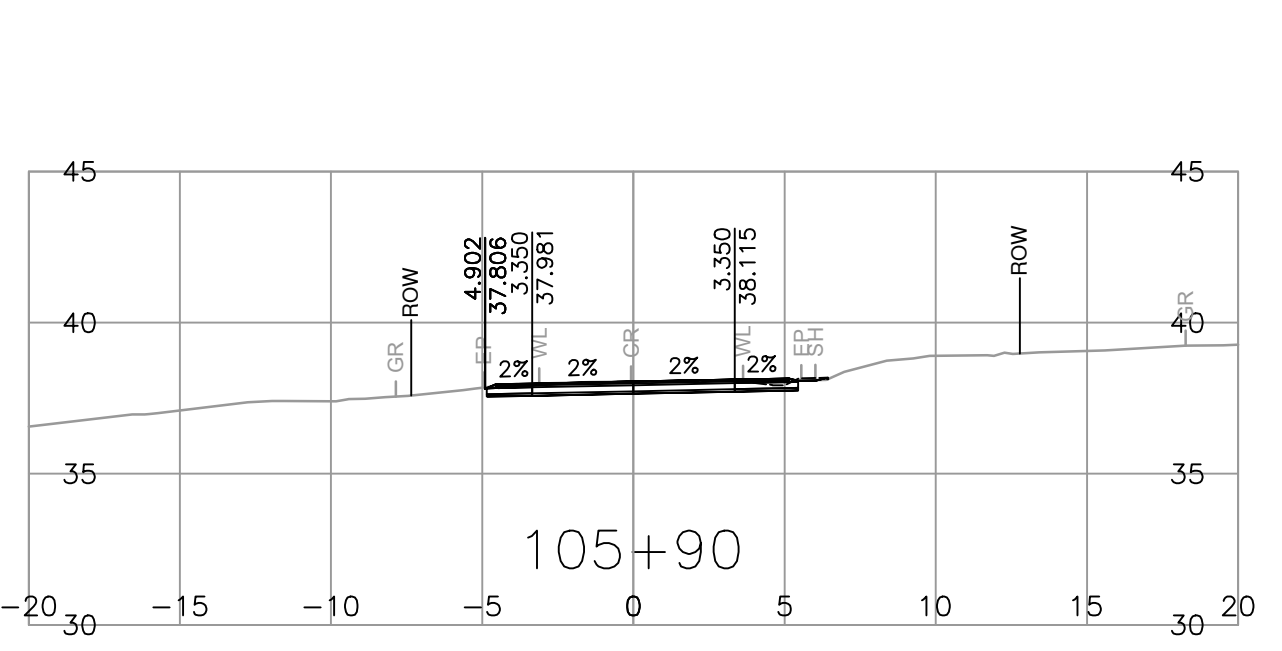
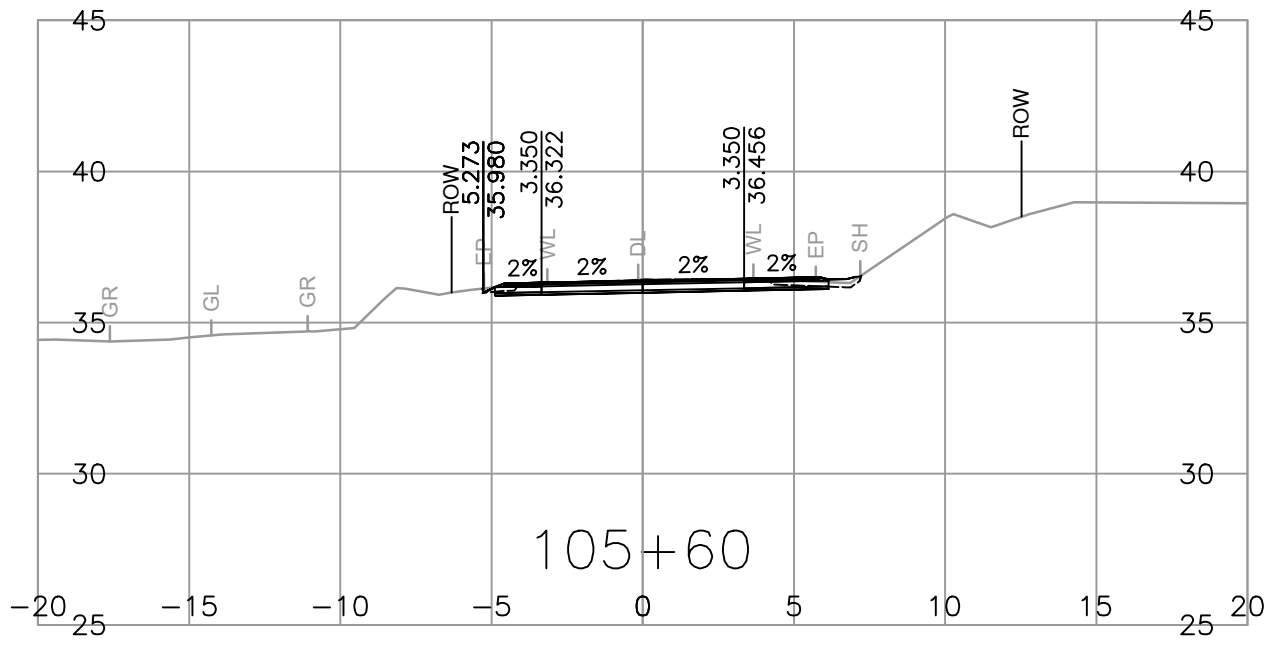
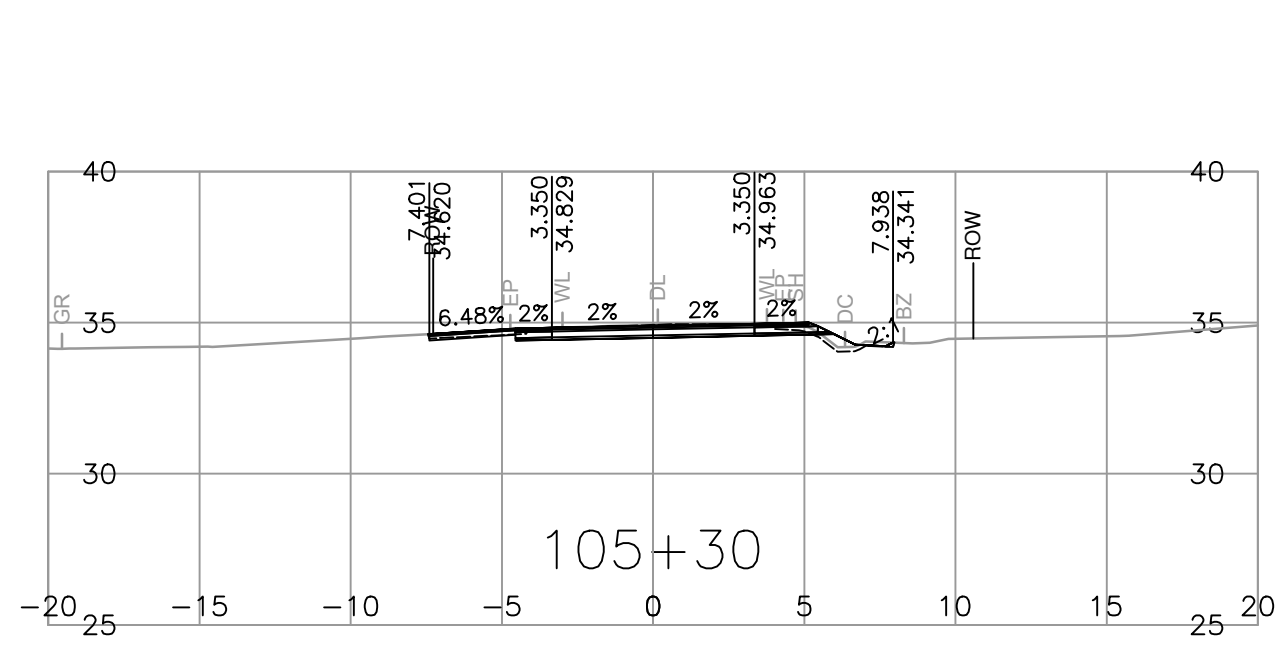
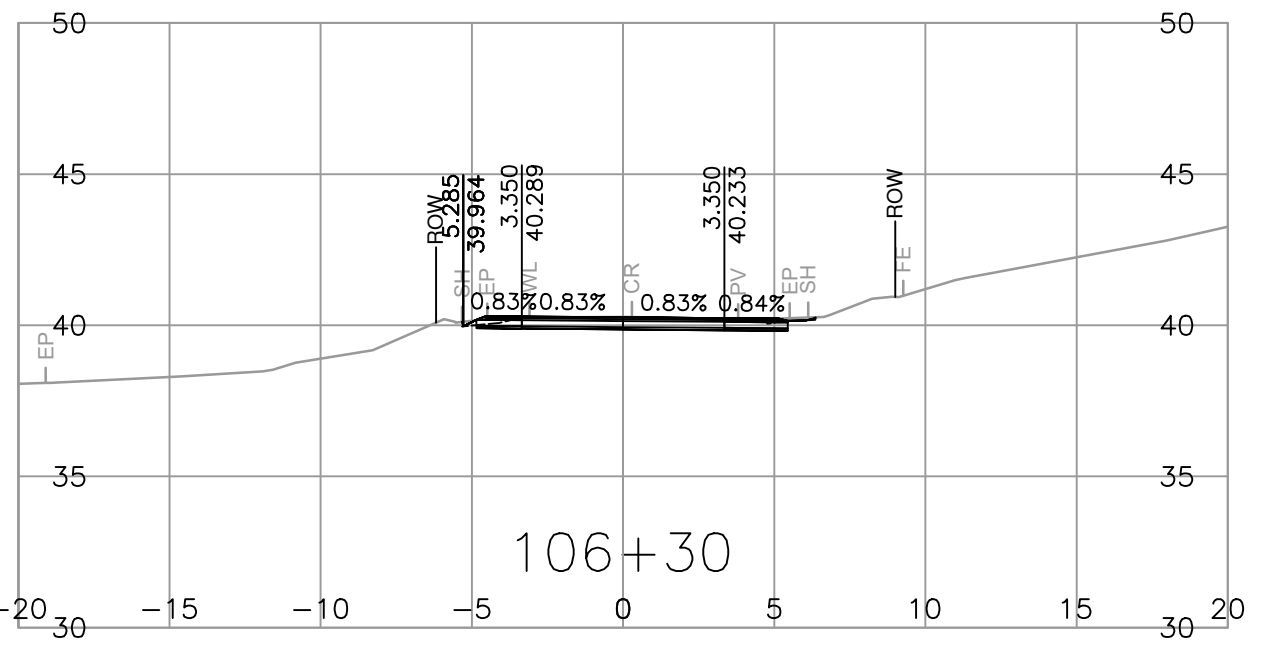
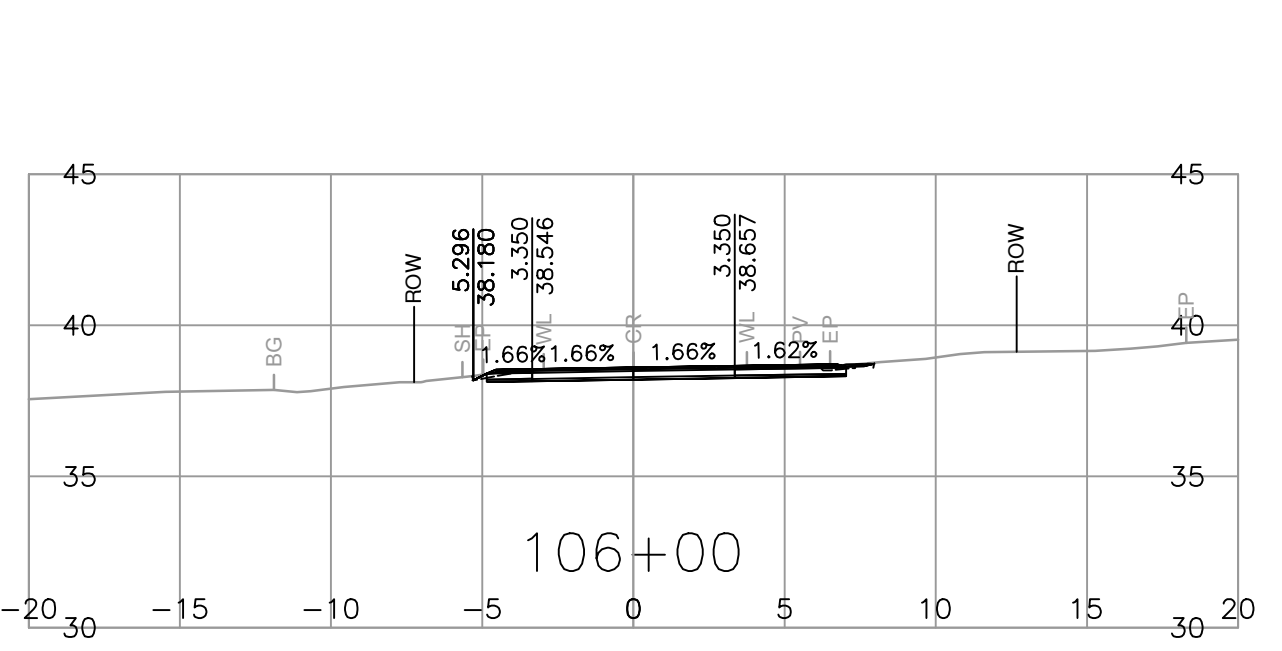
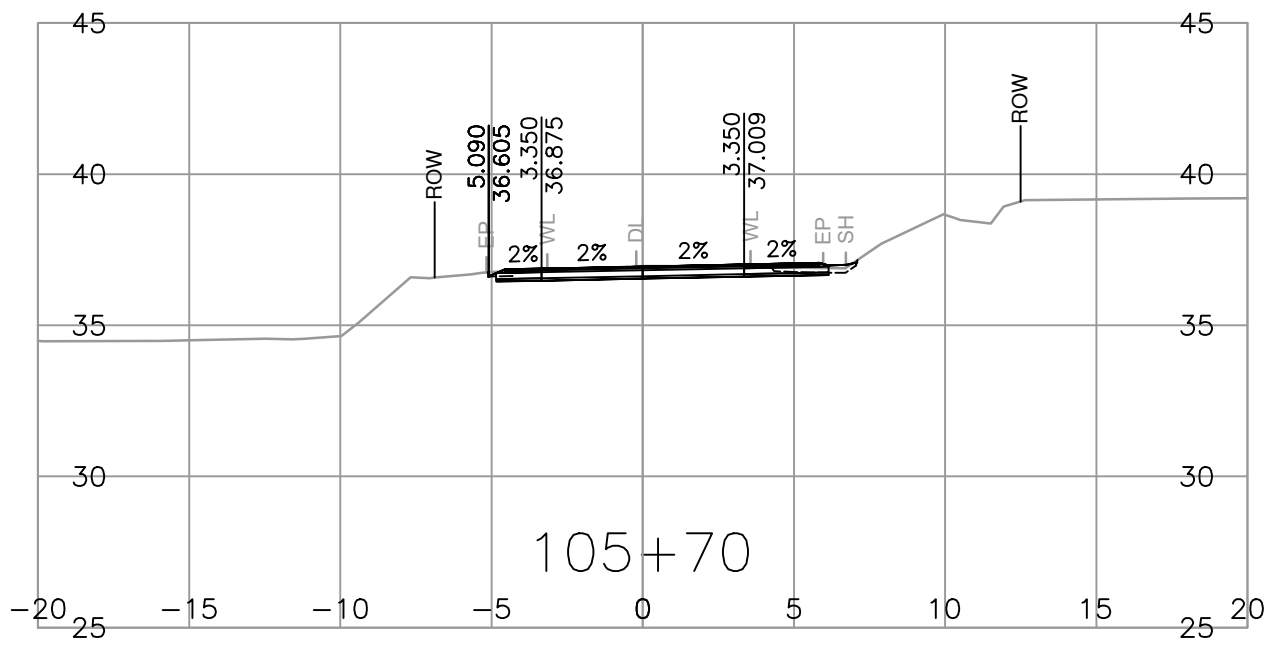
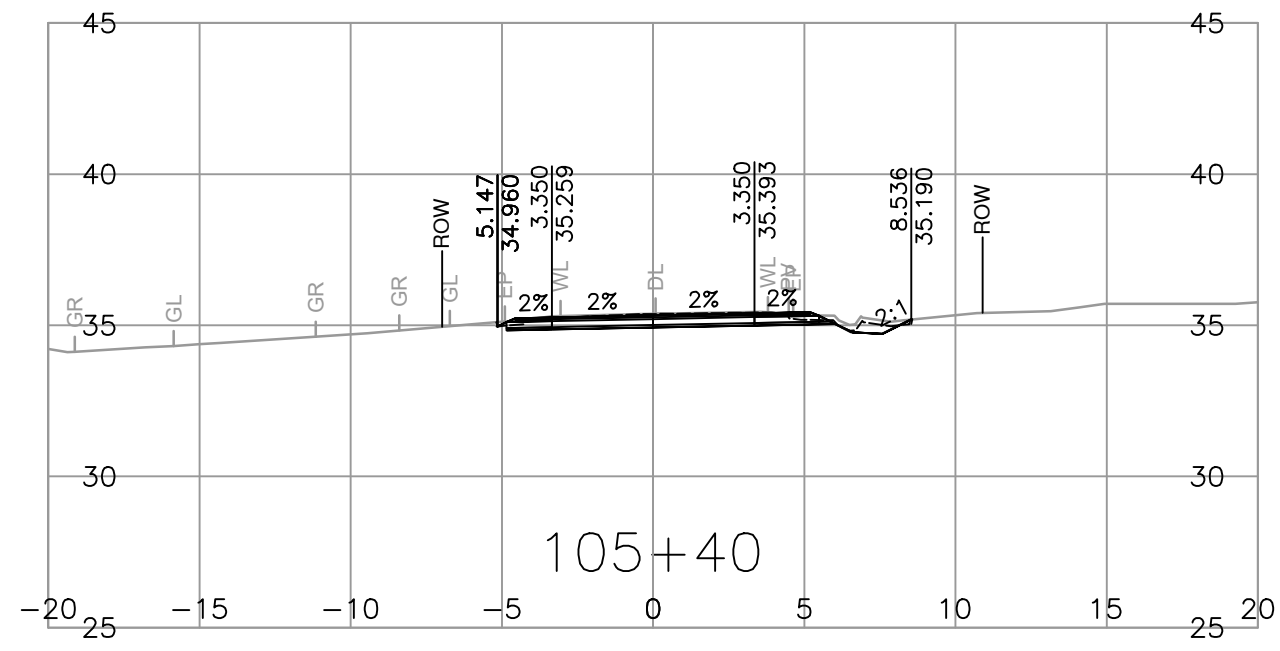

<p>SUITE 201, 8506 - 200 STREET LANGLEY, BRITISH COLUMBIA, V2Y 0M1 PH : 604.371.0091 FAX : 604.371.0098</p>	<p>SCALE 0 2 1:250 12m</p>	<p>CAD FILENAME R1-989-1000 PLOT DATE 2024-03-01</p>	<p>MINISTRY OF TRANSPORTATION AND INFRASTRUCTURE SOUTH COAST REGION VANCOUVER ISLAND DISTRICT</p>	<p>TEMPLATE CROSS SECTIONS FULFORD-GANGES ROAD IMPROVEMENT SEAVIEW AVENUE TO CRANBERRY ROAD</p>																										
	<table border="1"> <thead> <tr> <th>REV</th> <th>DATE</th> <th>REVISIONS</th> <th>NAME</th> </tr> </thead> <tbody> <tr><td> </td><td> </td><td> </td><td> </td></tr> <tr><td> </td><td> </td><td> </td><td> </td></tr> <tr><td> </td><td> </td><td> </td><td> </td></tr> </tbody> </table>	REV	DATE	REVISIONS	NAME													<p>DESIGNED <u>B. PEEBLES</u> DATE 2024-02-01 QUALITY CONTROL <u>Z. PENDON</u> DATE 2024-02-01 QUALITY ASSURANCE <u>A. SANTOS</u> DATE 2024-02-01 DRAWN <u>J. SHIM</u> DATE 2024-02-01</p>	<p>SENIOR DESIGNER _____ DATE _____</p>	<p>L100</p>	<table border="1"> <tr> <th>FILE NUMBER</th> <th>PROJECT NUMBER</th> <th>REG</th> <th>DRAWING NUMBER</th> <th>REV</th> </tr> <tr> <td>32836</td> <td>16873-0001</td> <td>1</td> <td>R1-989-1004</td> <td> </td> </tr> </table>	FILE NUMBER	PROJECT NUMBER	REG	DRAWING NUMBER	REV	32836	16873-0001	1	R1-989-1004
REV	DATE	REVISIONS	NAME																											
FILE NUMBER	PROJECT NUMBER	REG	DRAWING NUMBER	REV																										
32836	16873-0001	1	R1-989-1004																											

PLOT DATE: 2024/03/01 G:\Projects\32000\32836_MoTI_Fulford_Ganges_Road_Widening\02_CADD\DrawingProduction\1000_DesignSections\R1-989-1000.dwg

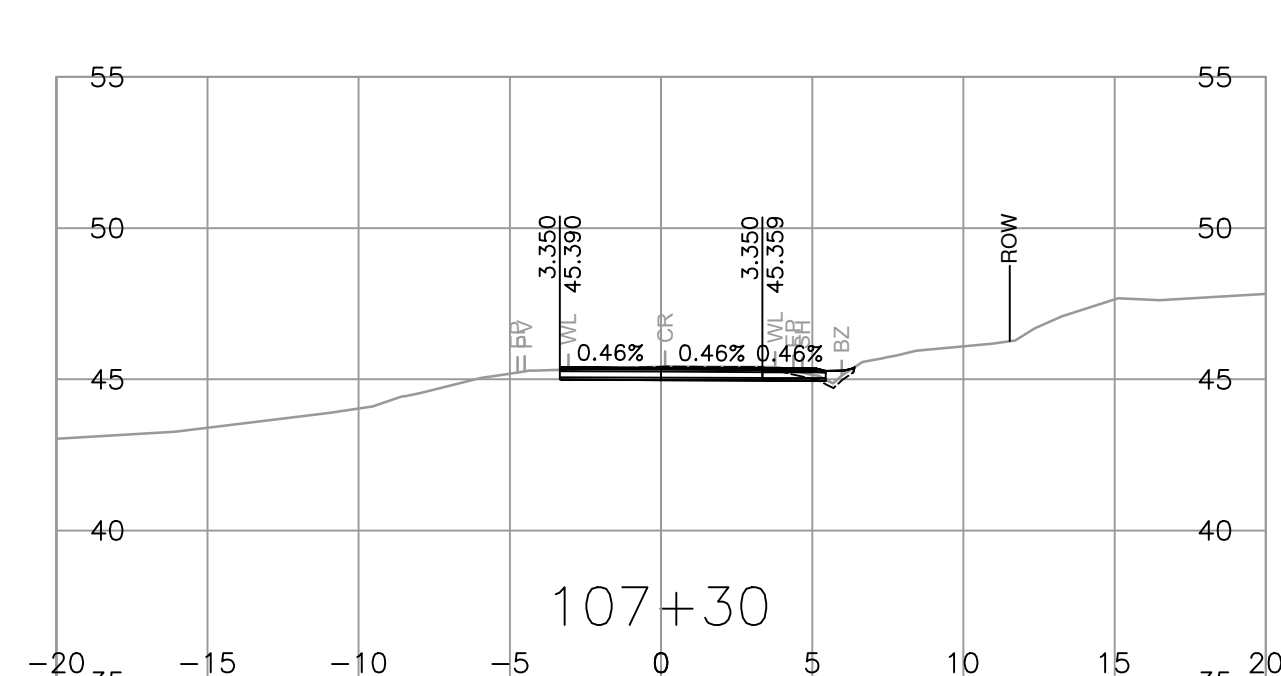
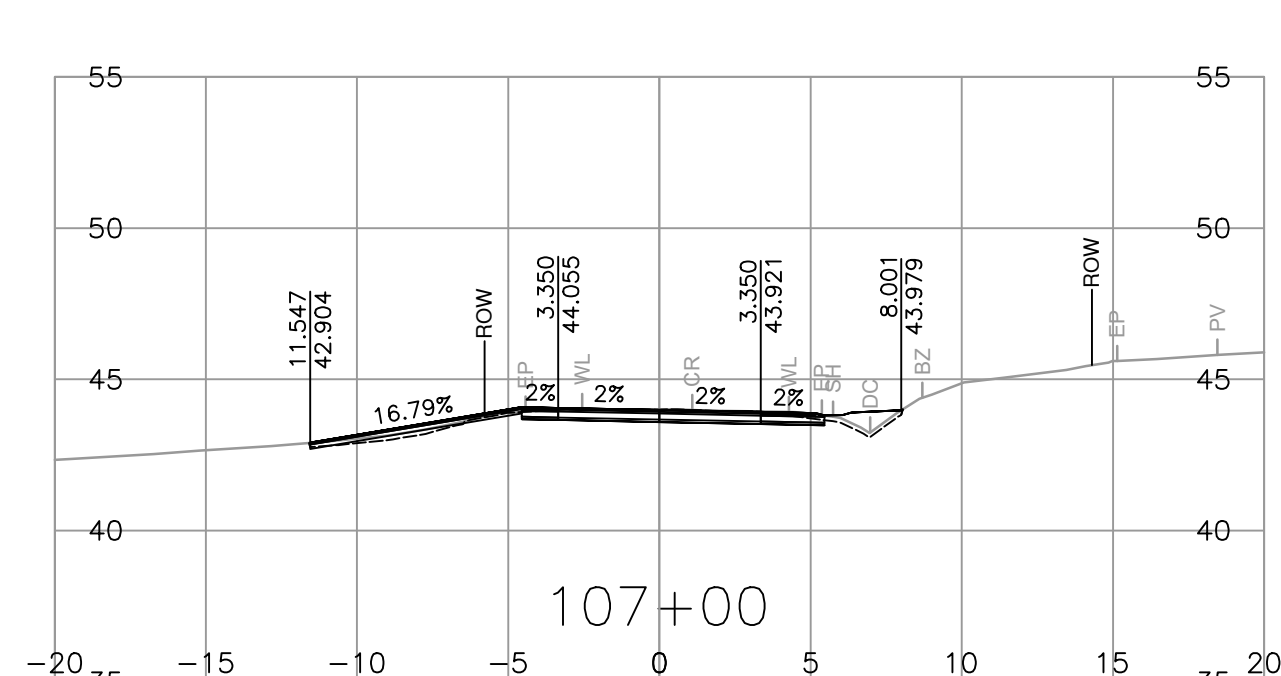
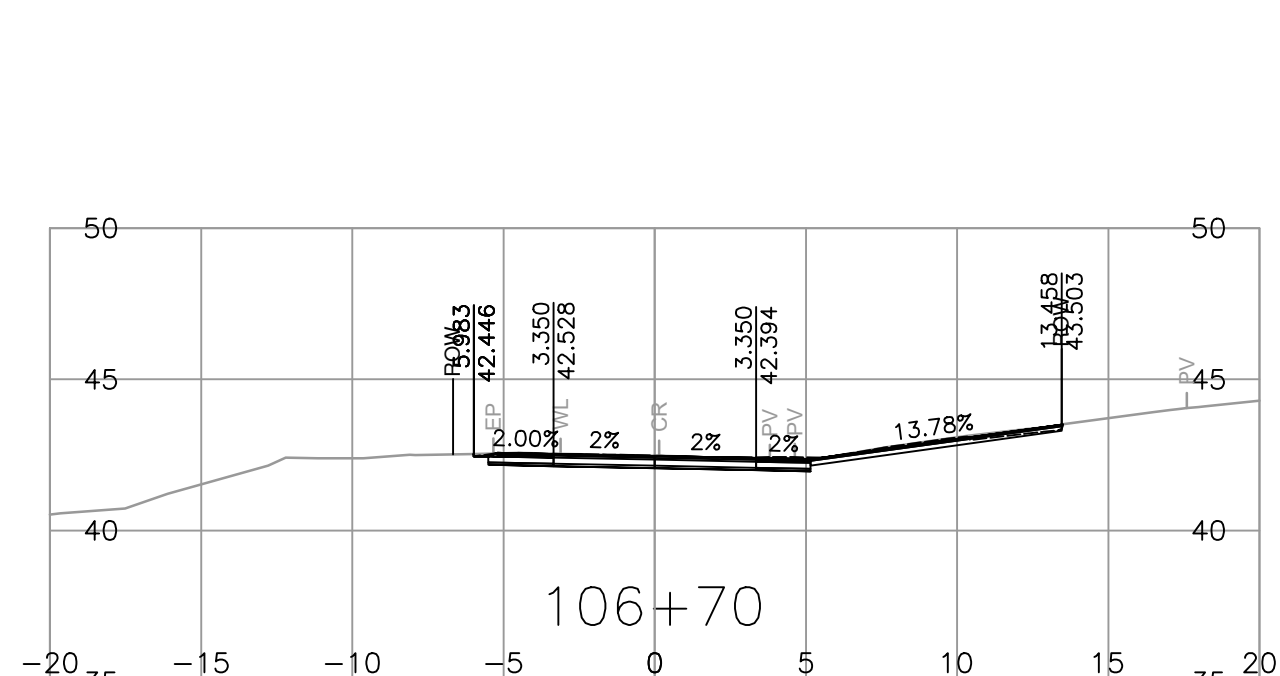
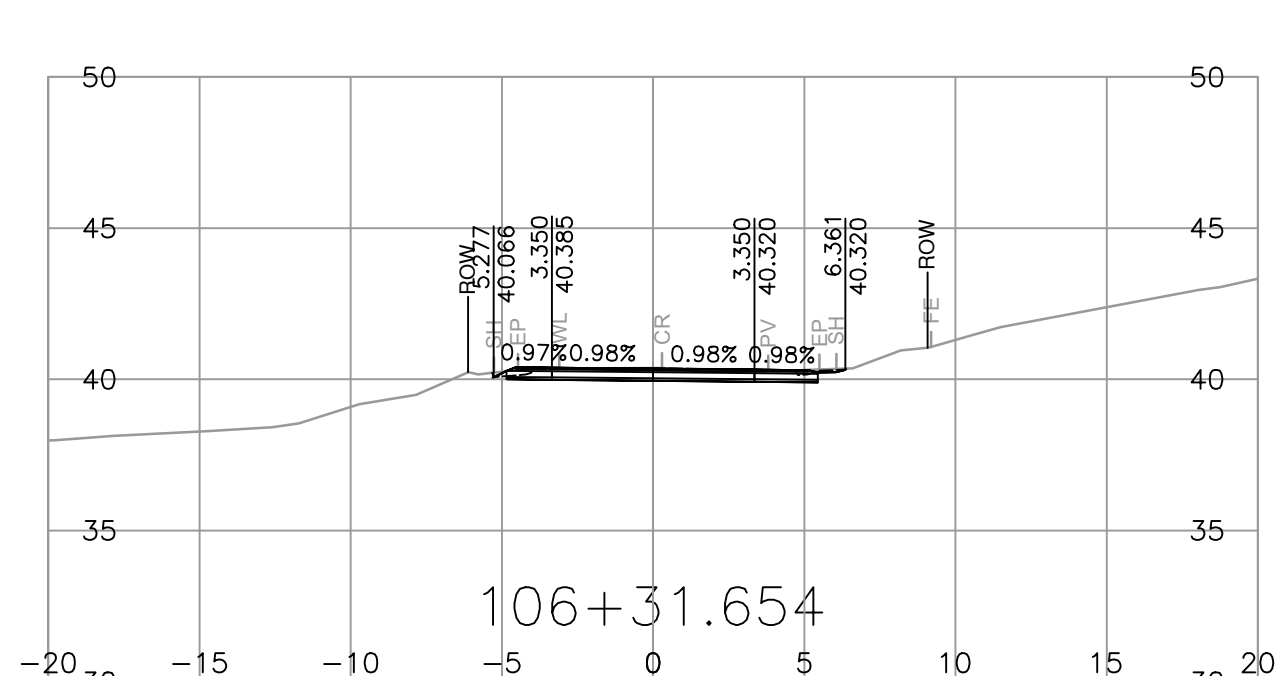
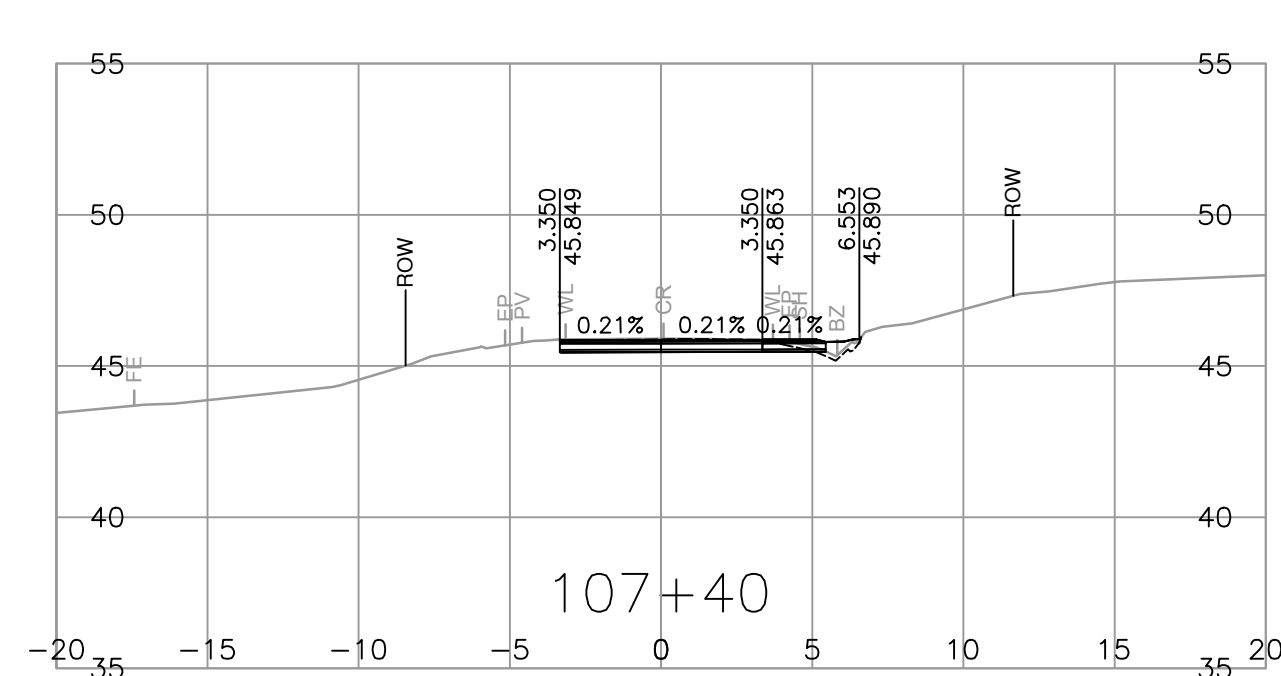
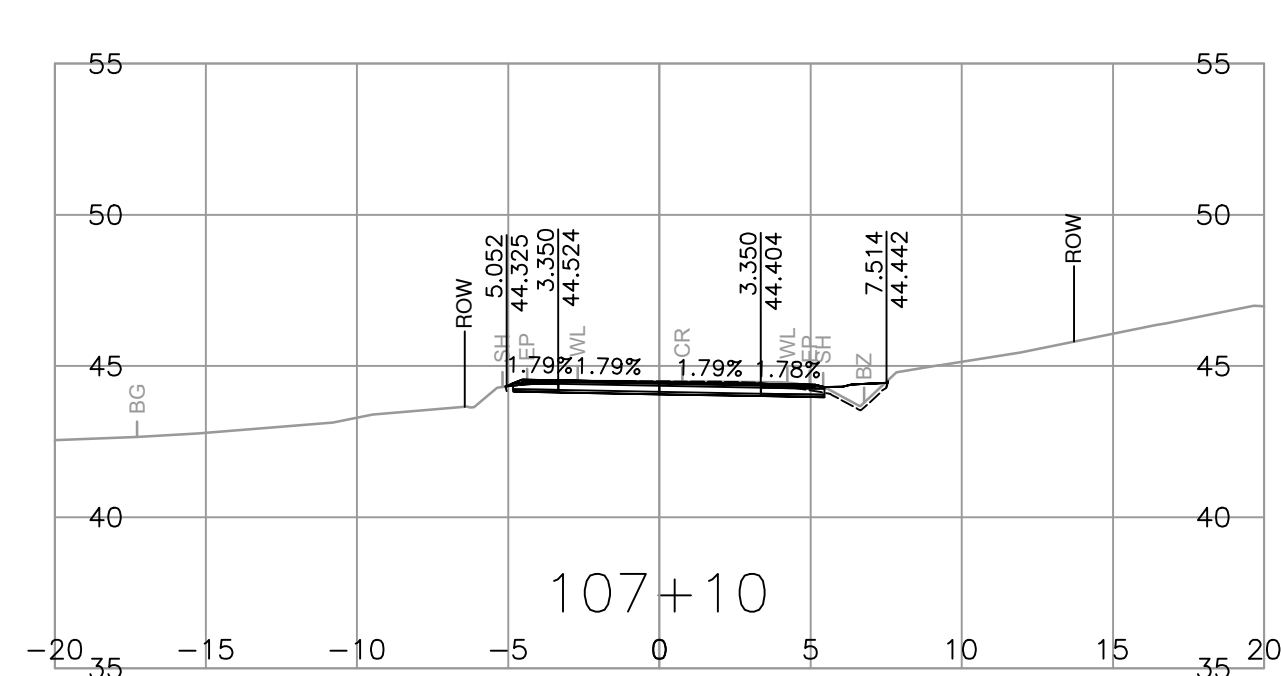
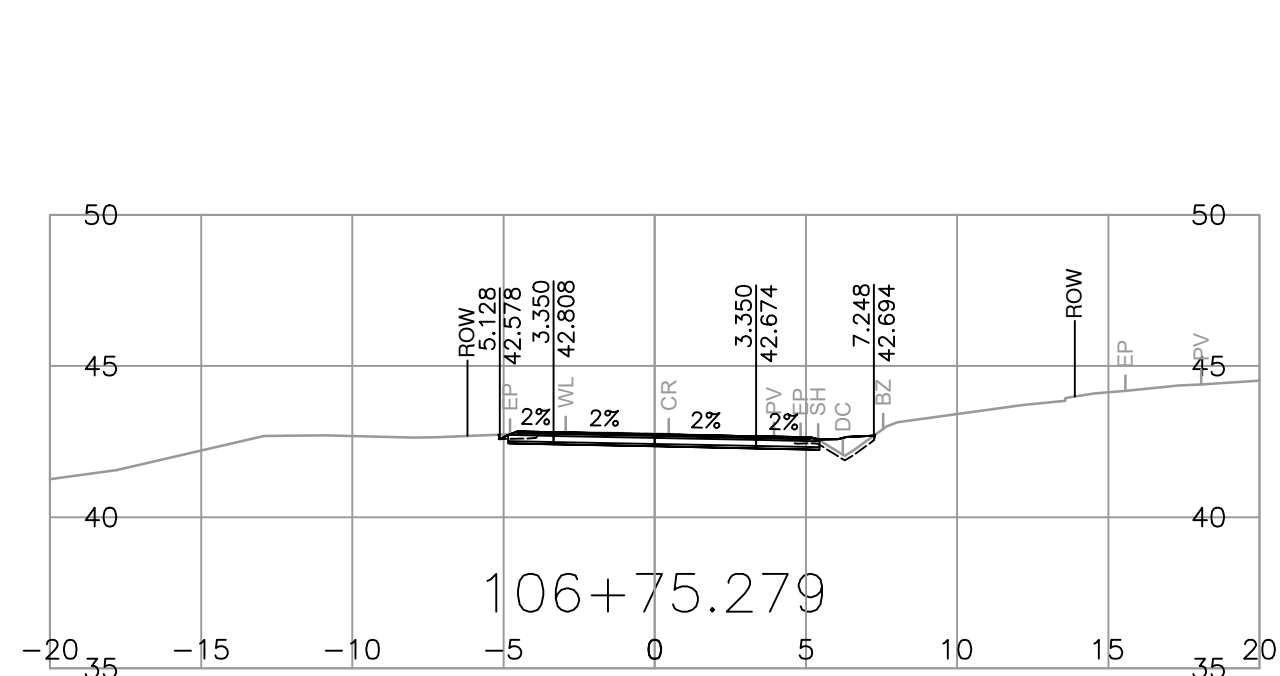
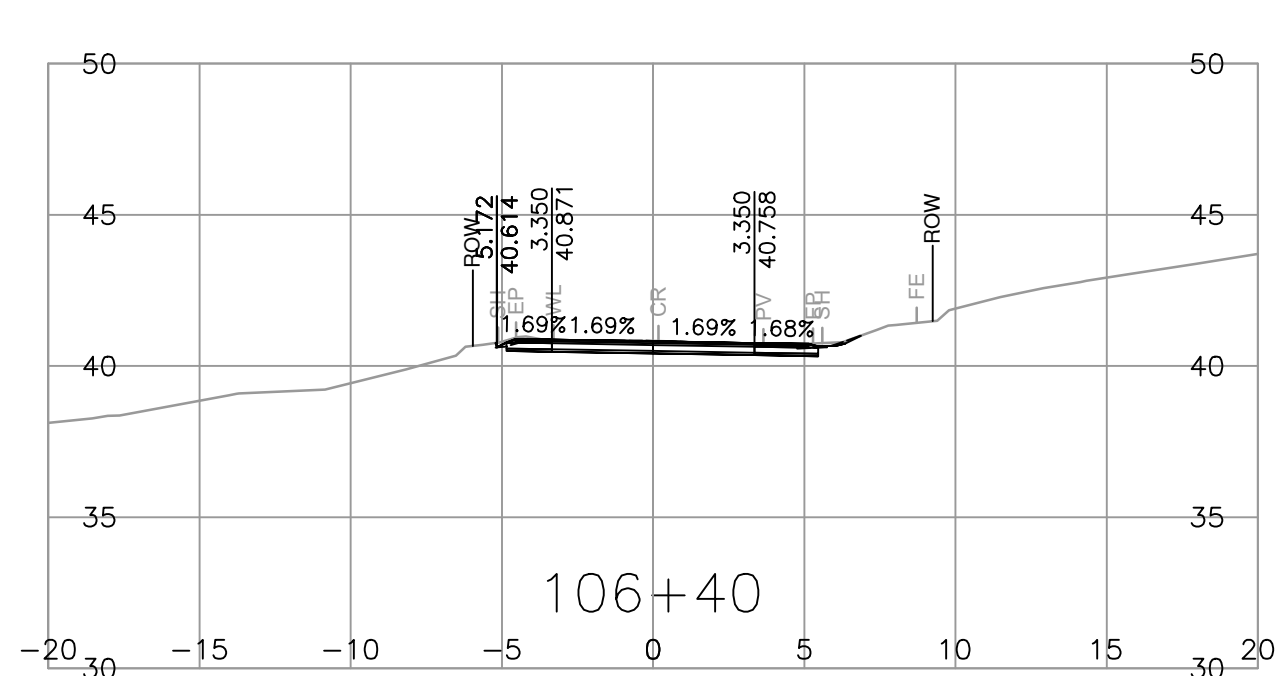
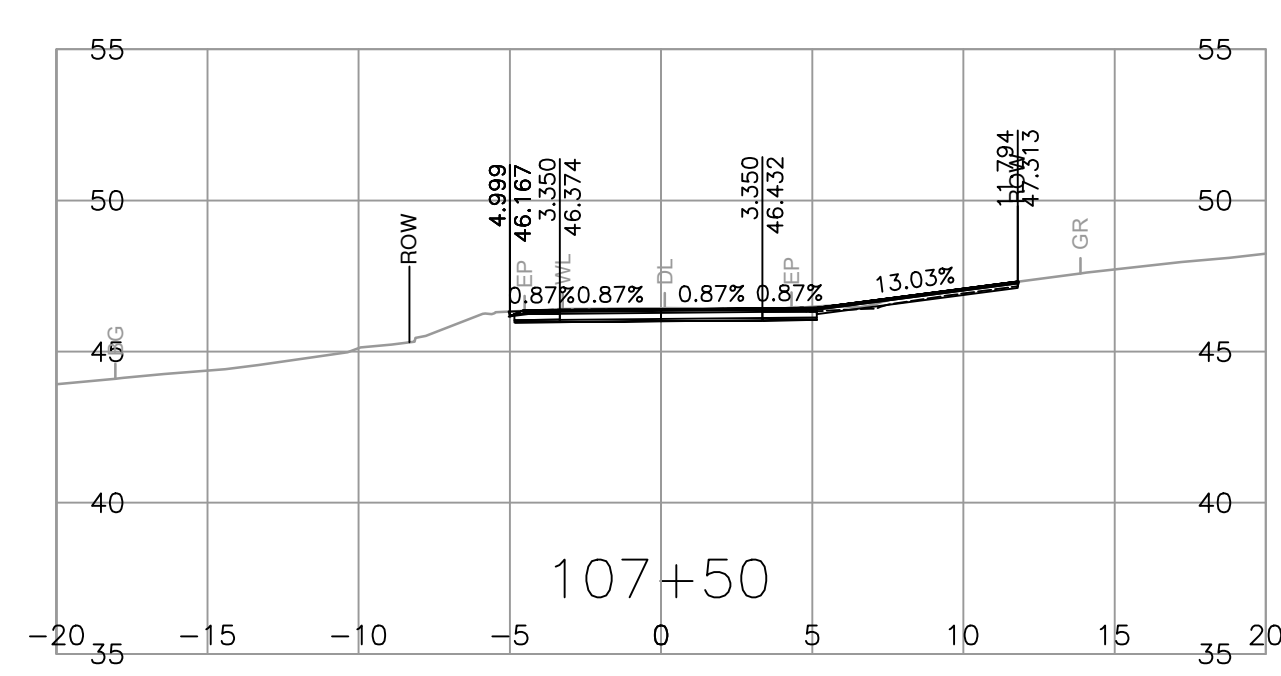
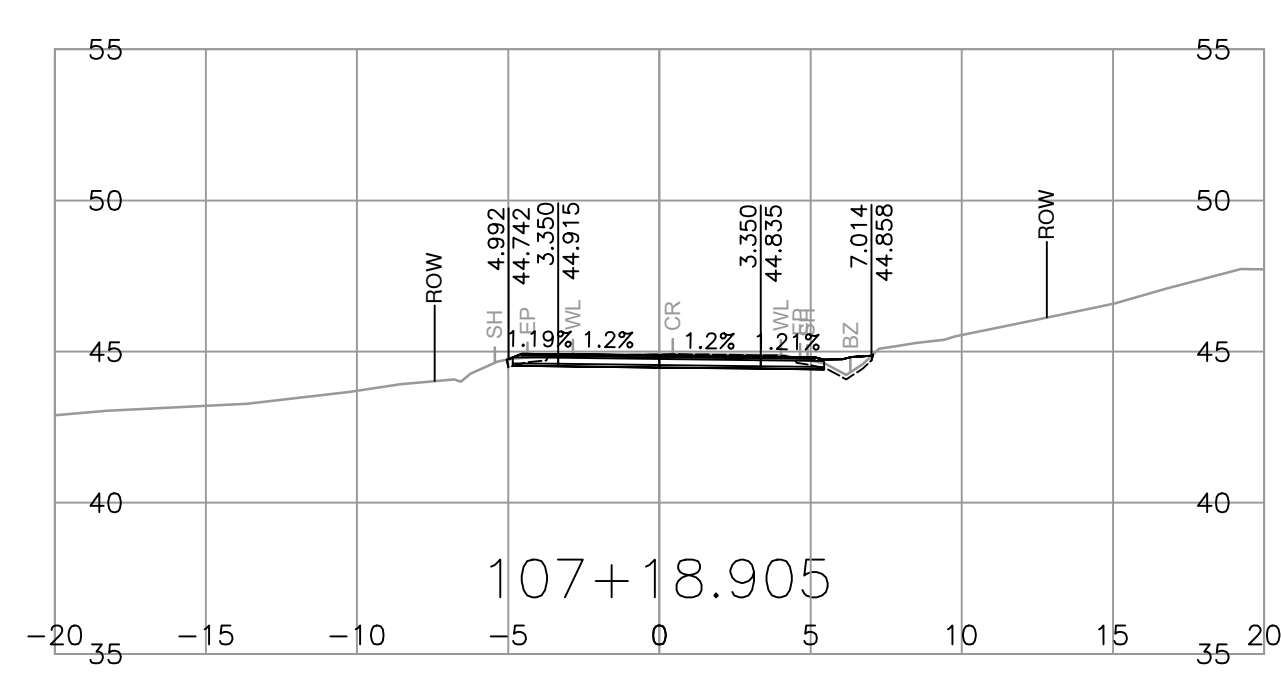
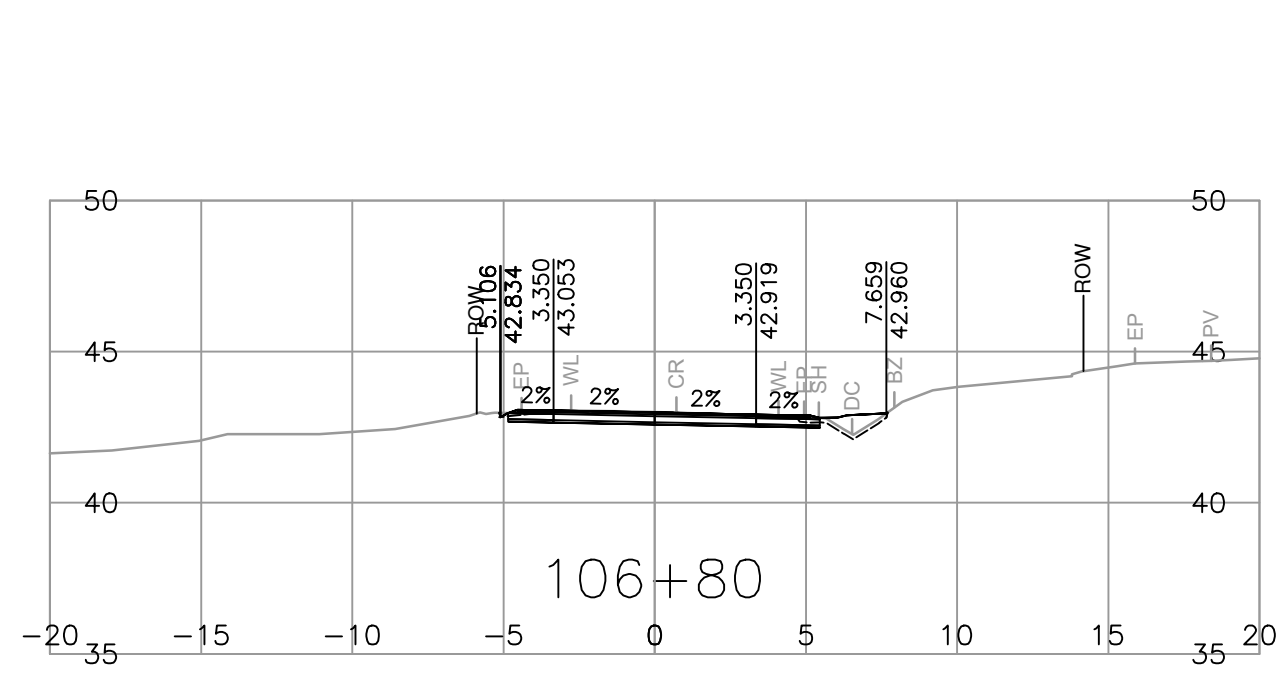
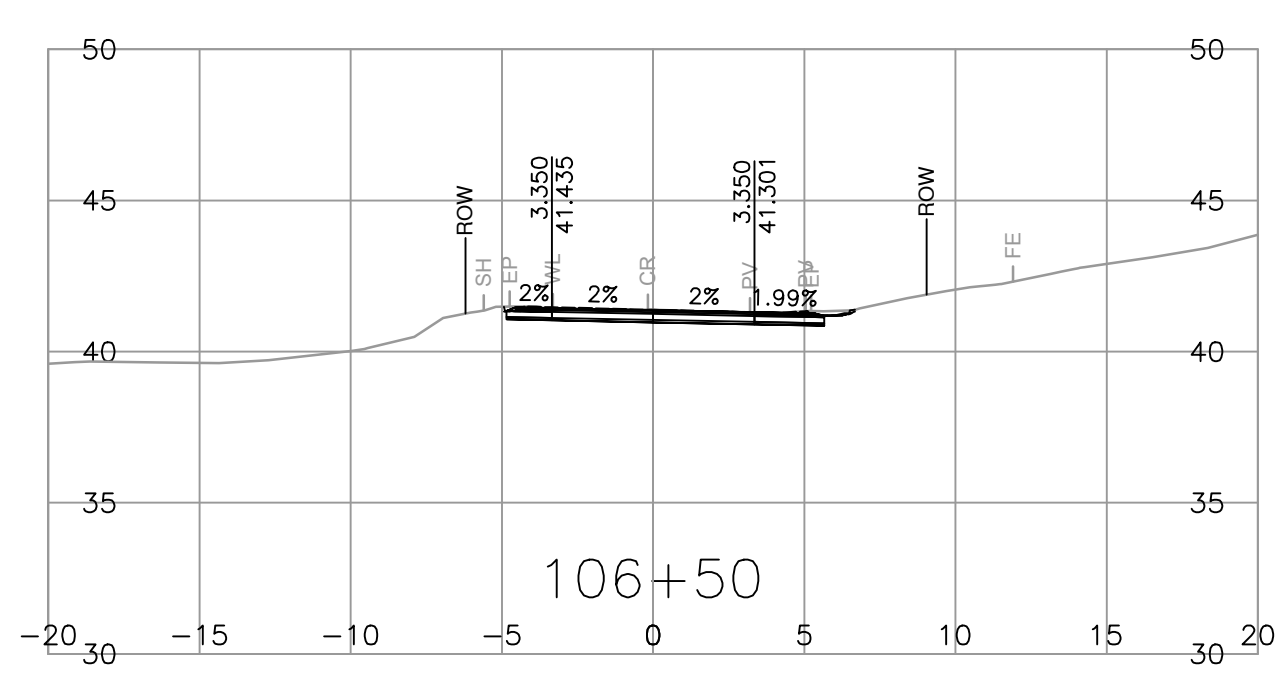
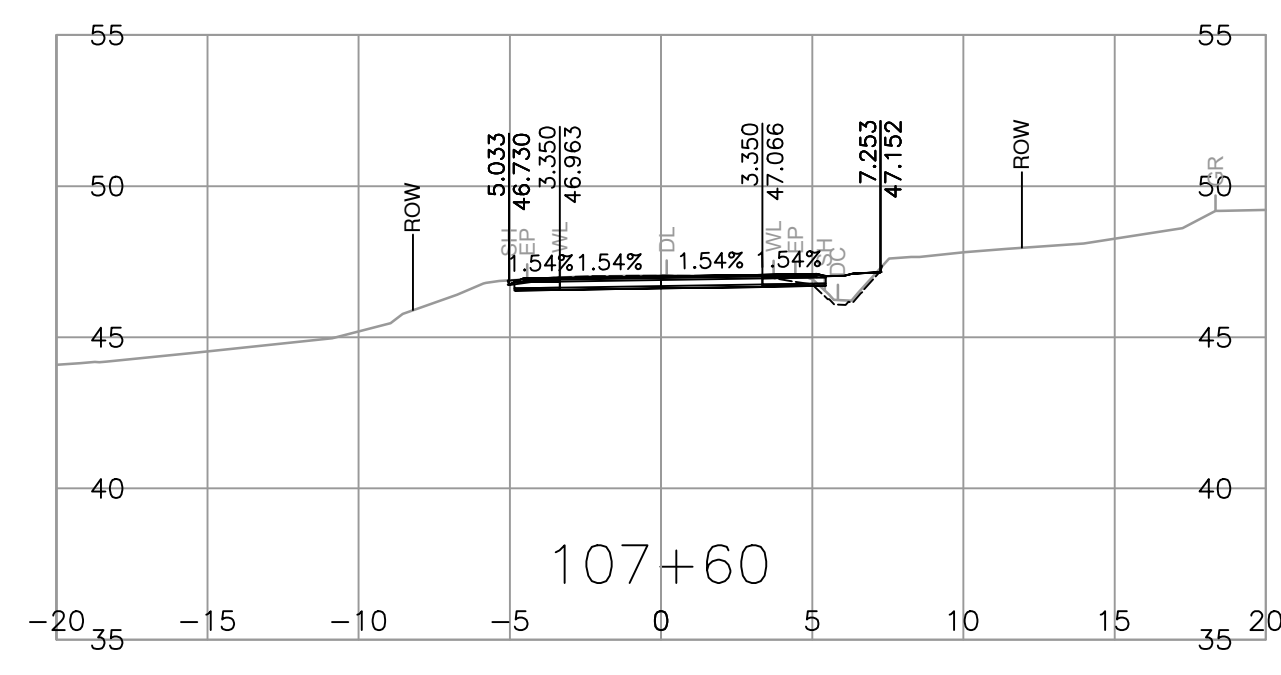
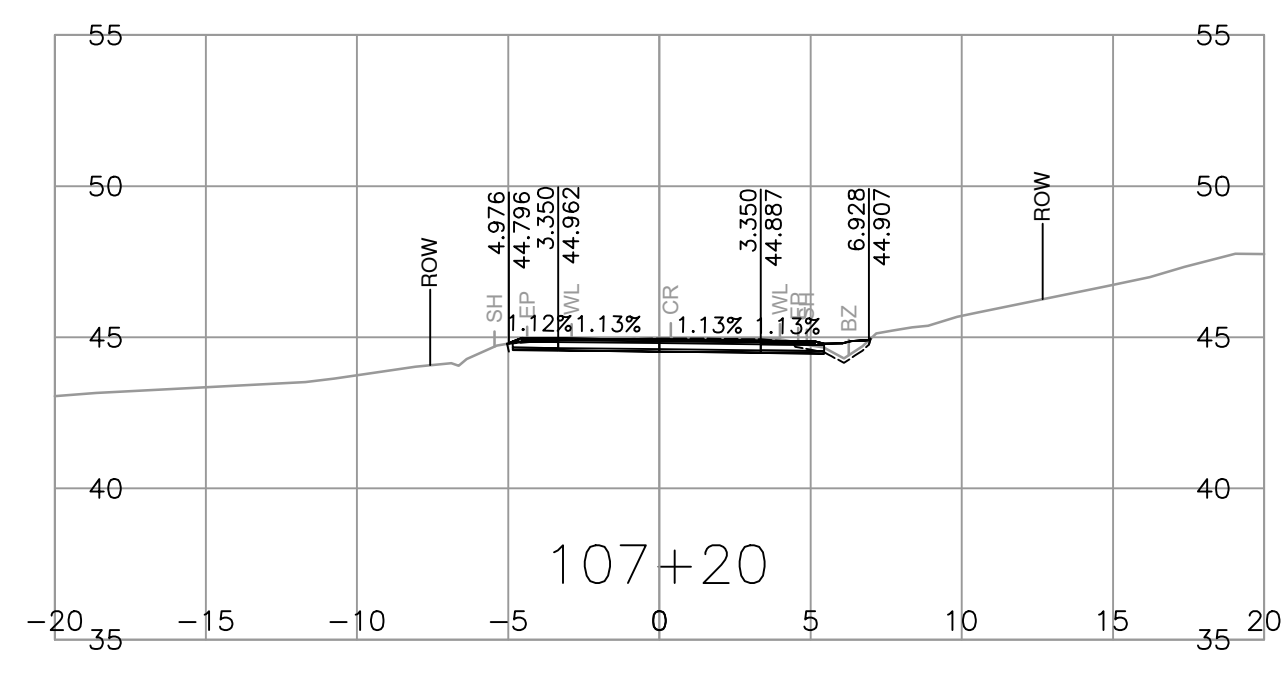
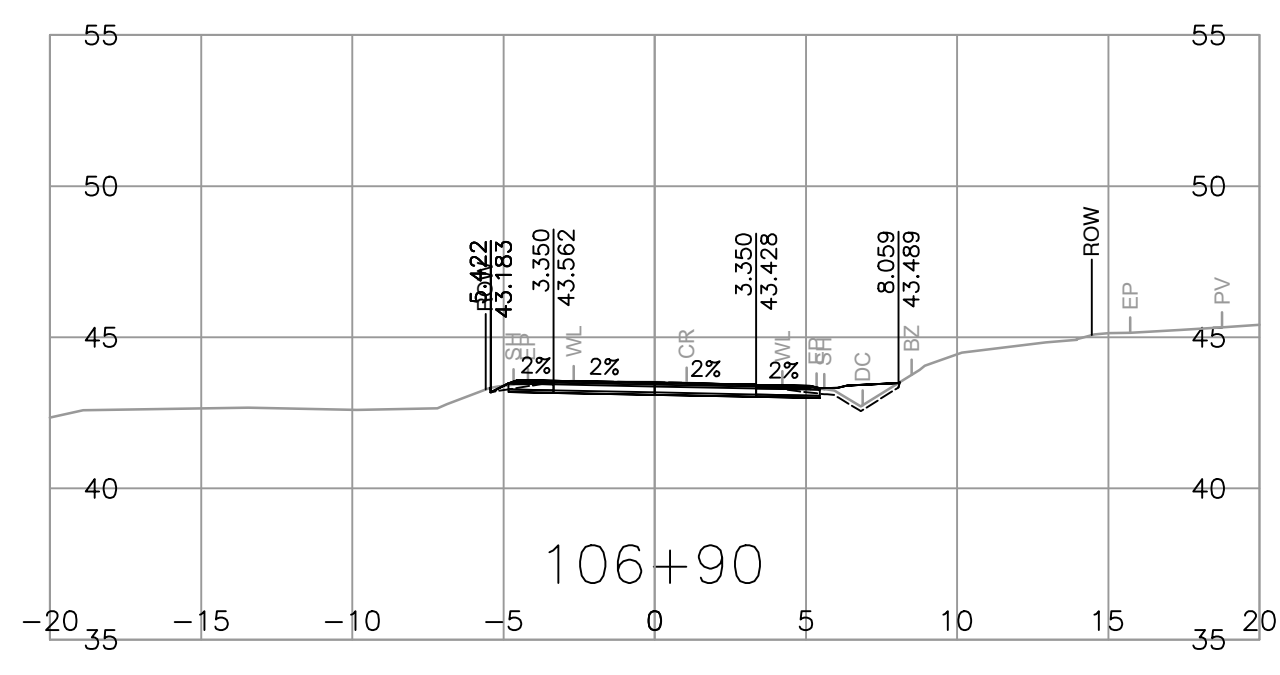
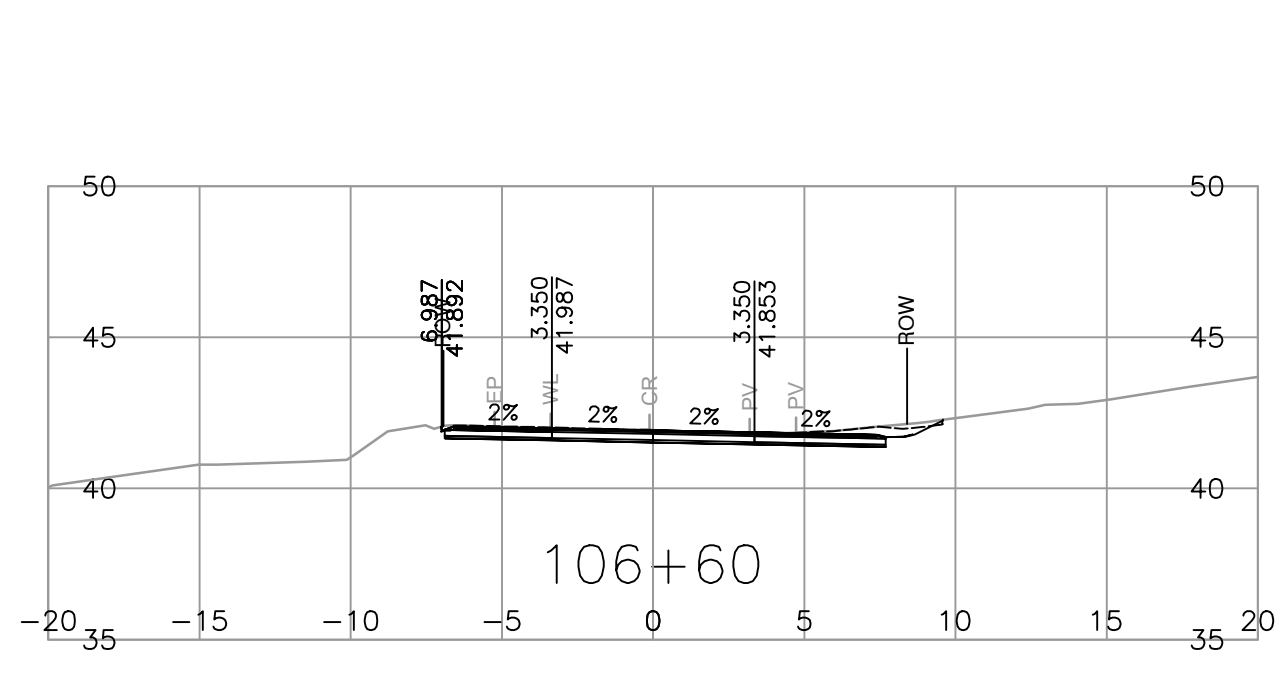

<p>SUITE 201, 8506 - 200 STREET LANGLEY, BRITISH COLUMBIA, V2Y 0M1 PH : 604.371.0091 FAX : 604.371.0098</p>	<p>SCALE 0 2 1:250 12m</p>	<p>CAD FILENAME R1-989-1000 PLOT DATE 2024-03-01</p>	<p>MINISTRY OF TRANSPORTATION AND INFRASTRUCTURE SOUTH COAST REGION VANCOUVER ISLAND DISTRICT</p>	<p>TEMPLATE CROSS SECTIONS FULFORD-GANGES ROAD IMPROVEMENT SEAVIEW AVENUE TO CRANBERRY ROAD</p>																		
	<table border="1"> <thead> <tr> <th>REV</th> <th>DATE</th> <th>REVISIONS</th> <th>NAME</th> </tr> </thead> <tbody> <tr> <td> </td> <td> </td> <td> </td> <td> </td> </tr> </tbody> </table>	REV	DATE	REVISIONS	NAME					<p>DESIGNED B. PEEBLES DATE 2024-02-01 QUALITY CONTROL Z. PENDON DATE 2024-02-01 QUALITY ASSURANCE A. SANTOS DATE 2024-02-01 DRAWN J. SHIM DATE 2024-02-01</p>	<p>L100</p> <table border="1"> <tr> <td>FILE NUMBER</td> <td>PROJECT NUMBER</td> <td>REG</td> <td>DRAWING NUMBER</td> <td>REV</td> </tr> <tr> <td>32836</td> <td>16873-0001</td> <td>1</td> <td>R1-989-1005</td> <td> </td> </tr> </table>		FILE NUMBER	PROJECT NUMBER	REG	DRAWING NUMBER	REV	32836	16873-0001	1	R1-989-1005	
	REV	DATE	REVISIONS	NAME																		
FILE NUMBER	PROJECT NUMBER	REG	DRAWING NUMBER	REV																		
32836	16873-0001	1	R1-989-1005																			
<p>SENIOR DESIGNER _____ DATE _____</p>	<p> </p>																					

PLOT DATE: 2024/03/01 G:\Projects\32000\32836_MoTI_Fulford_Ganges_Road_Widening\02_CADD\DrawingProduction\1000_DesignSections\R1-989-1000.dwg

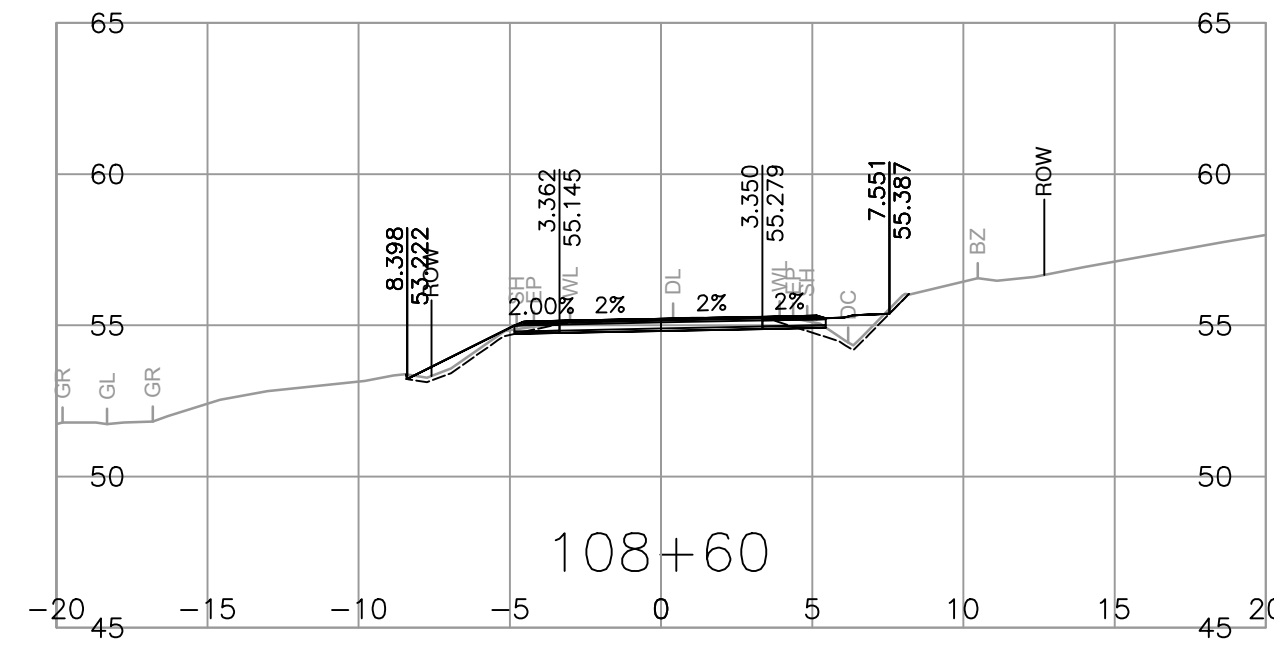
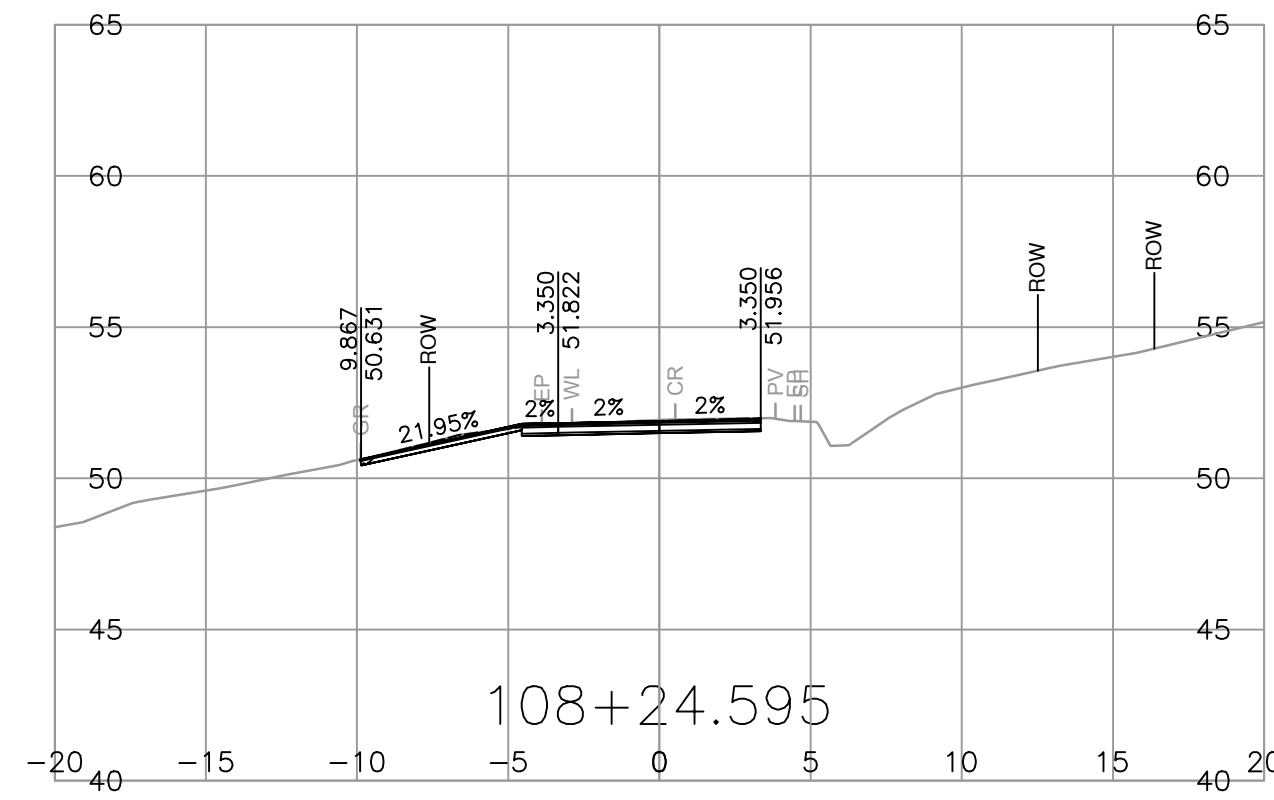
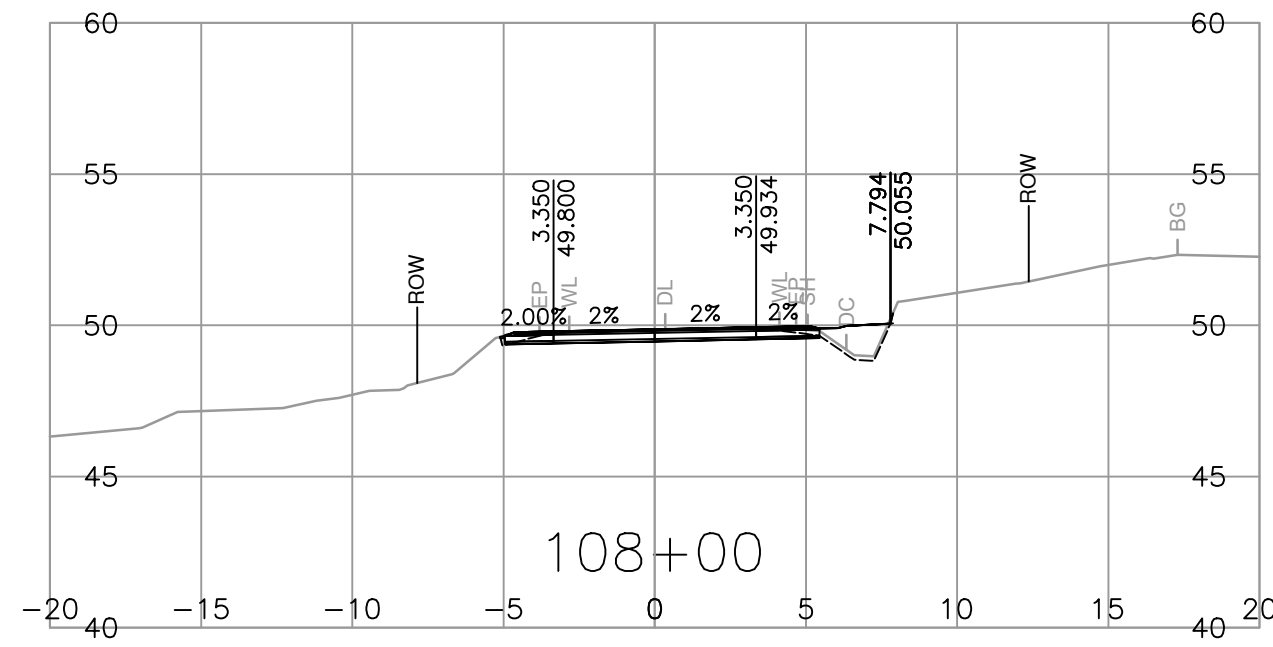
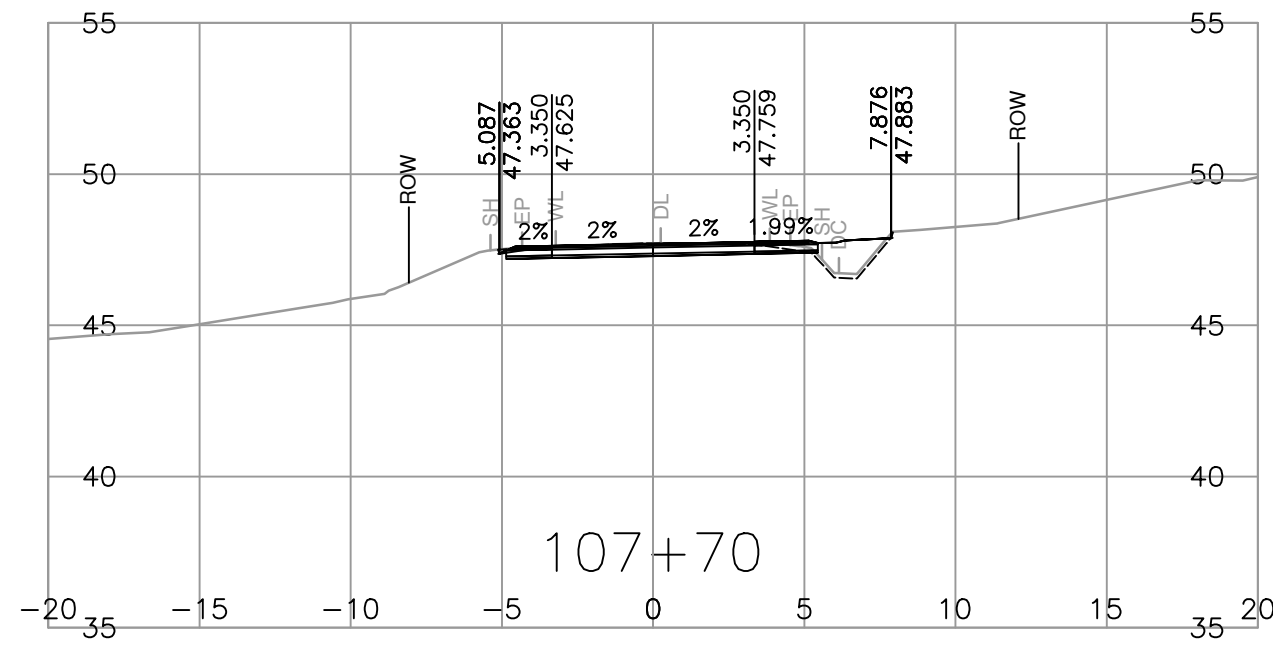
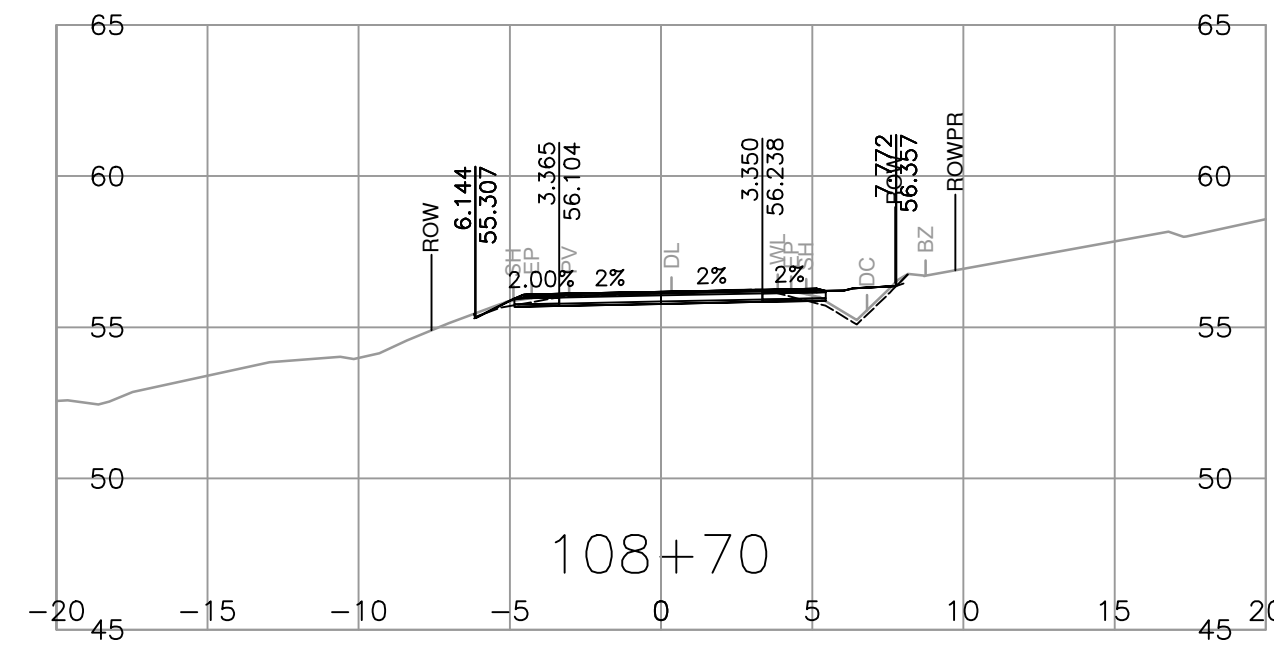
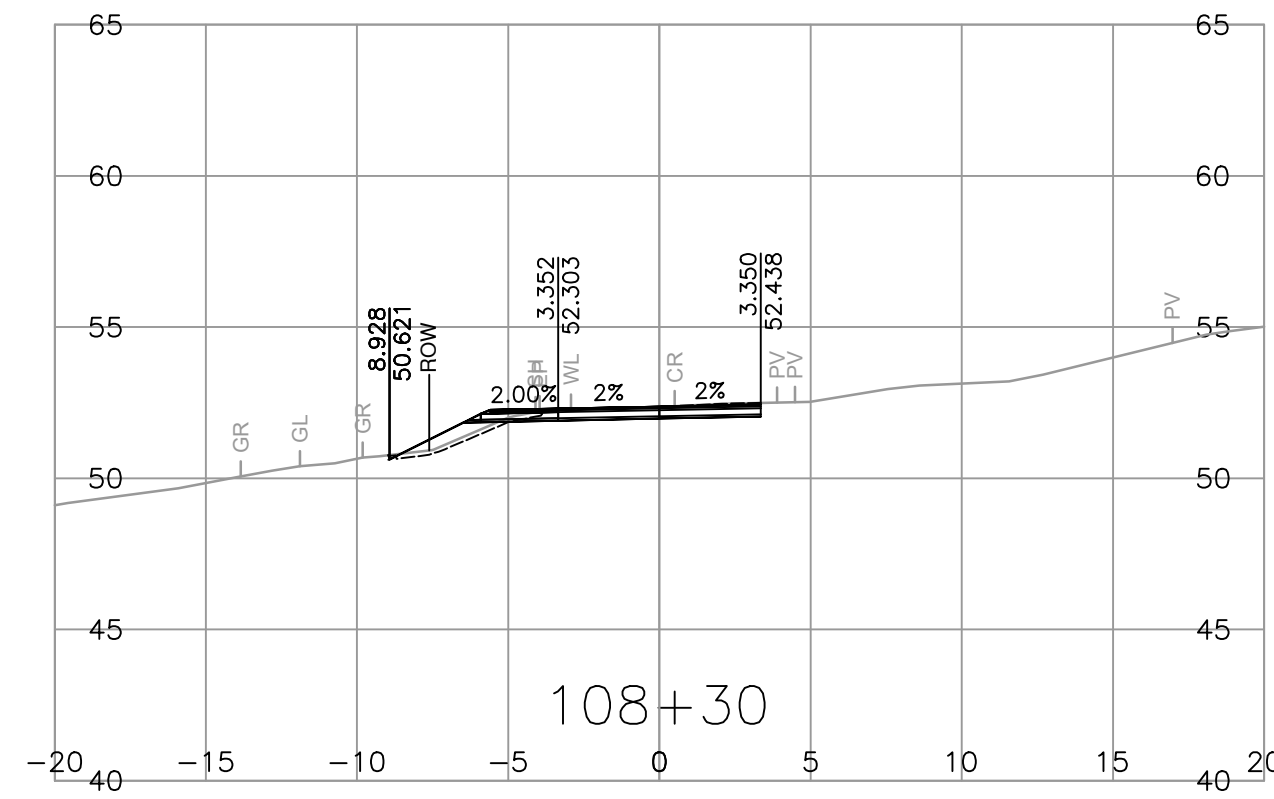
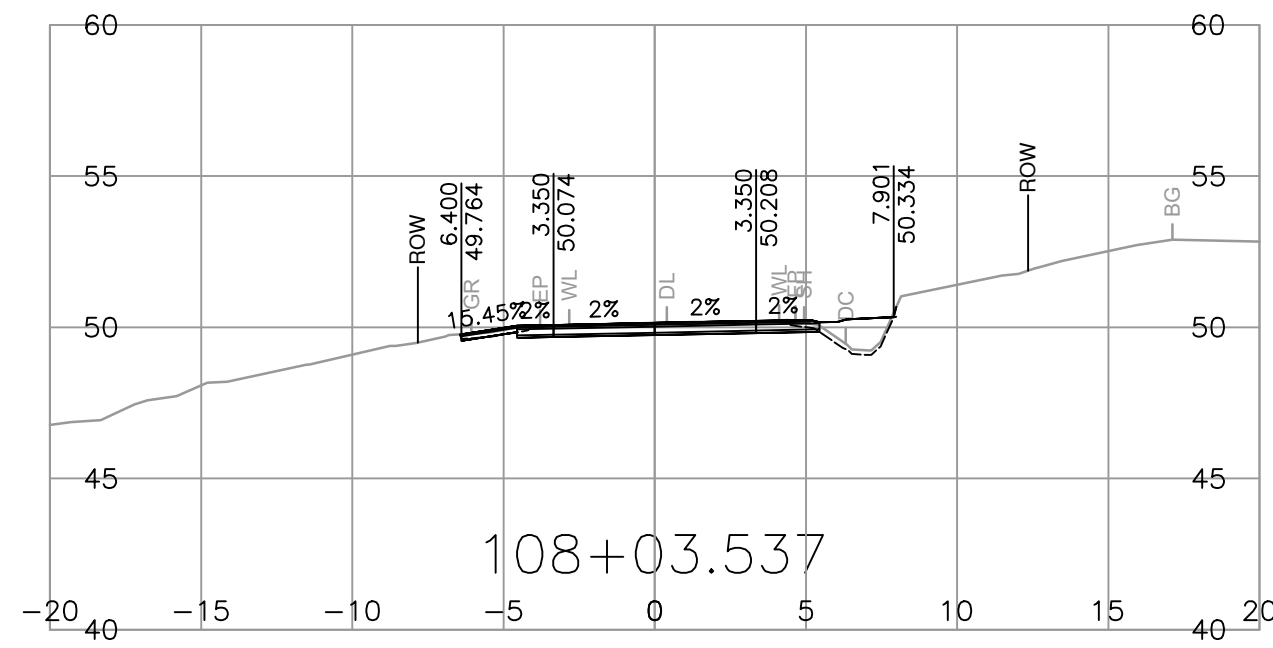
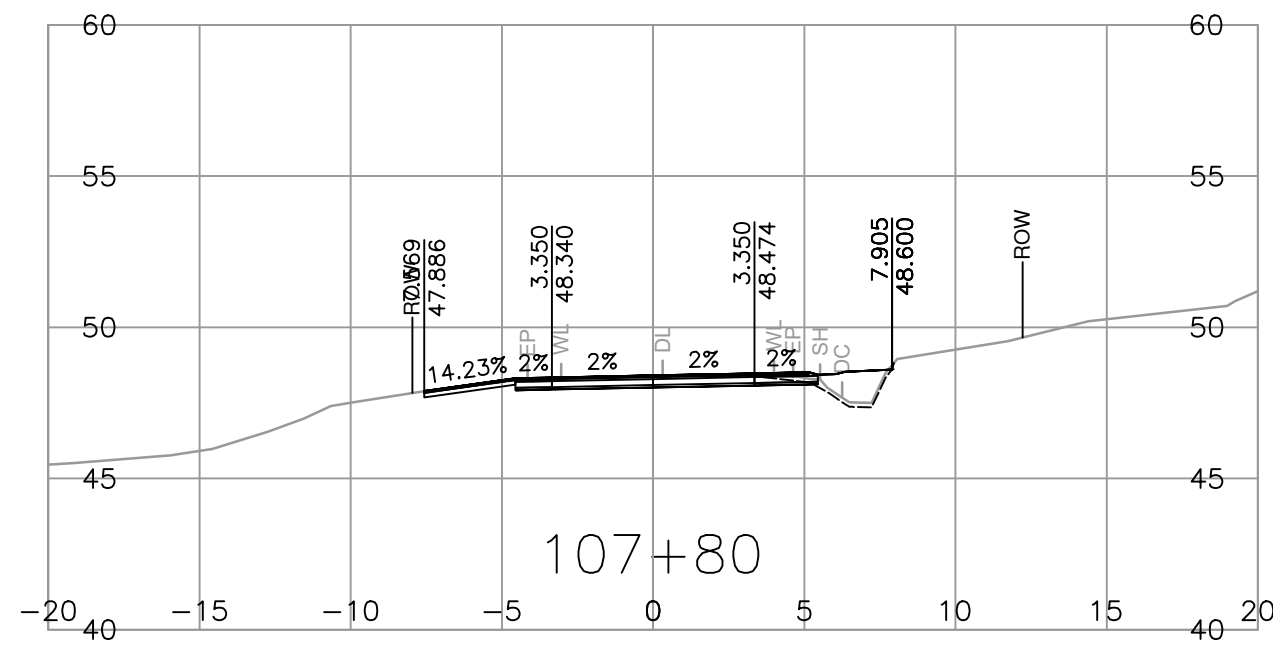
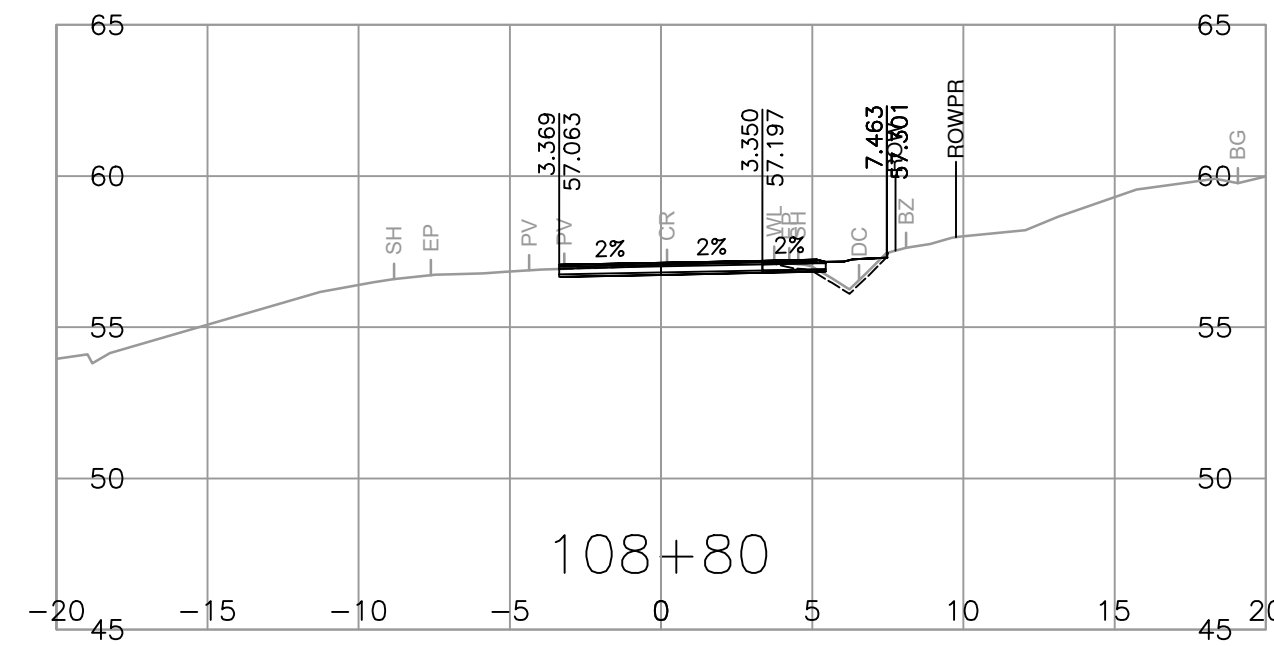
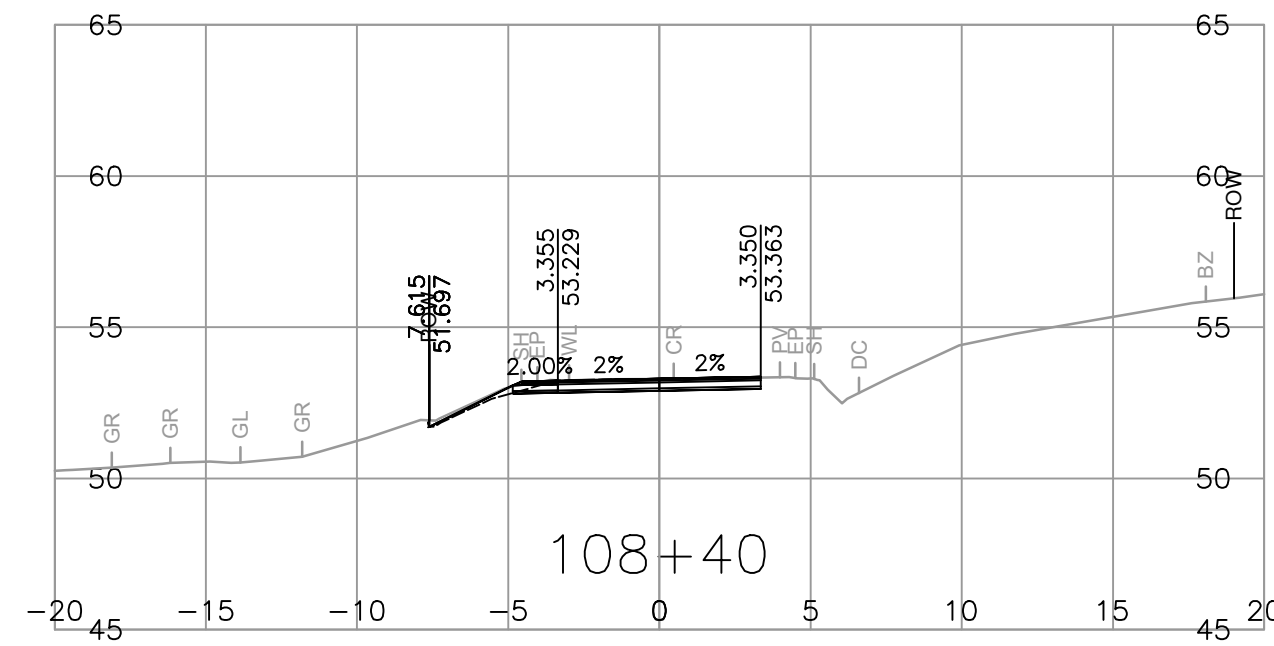
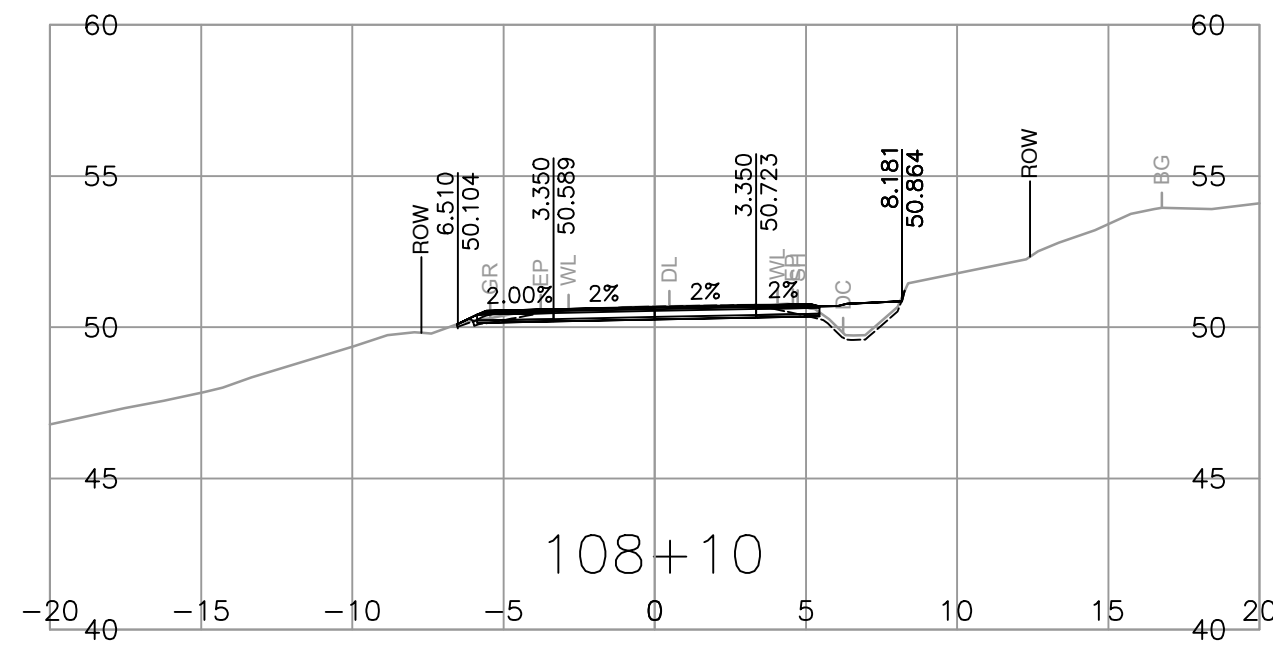
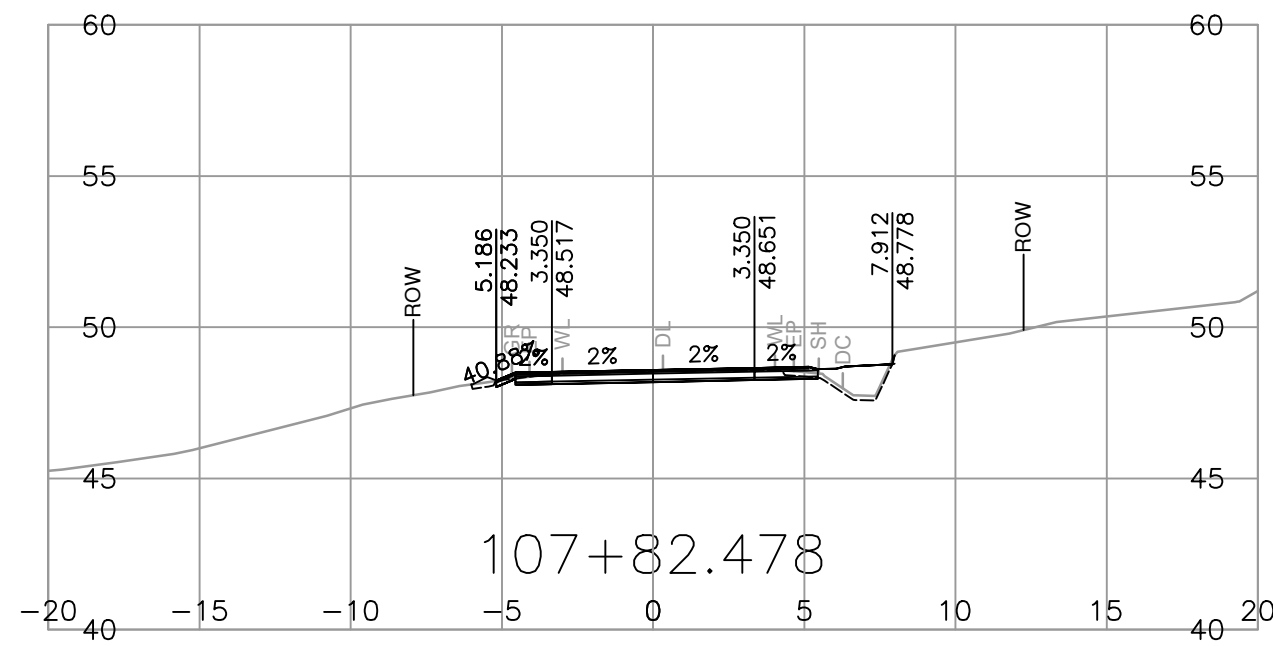
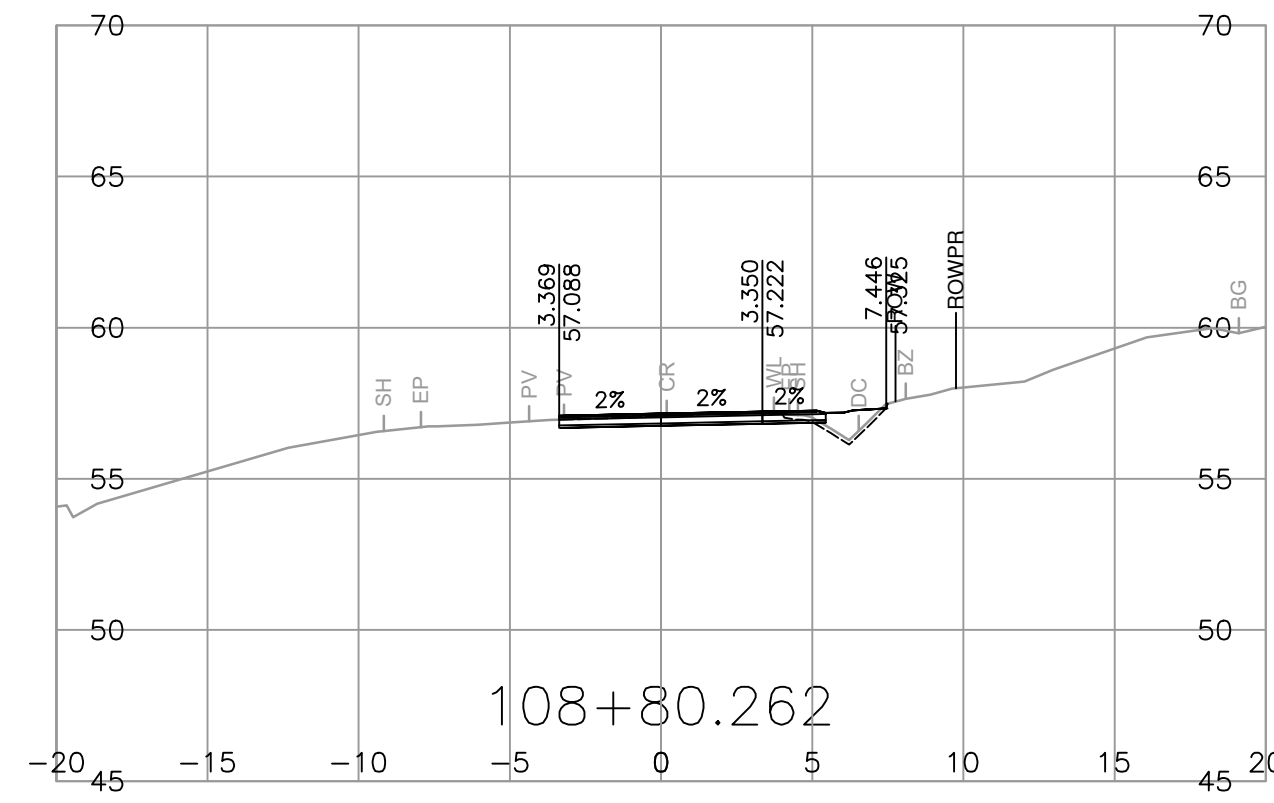
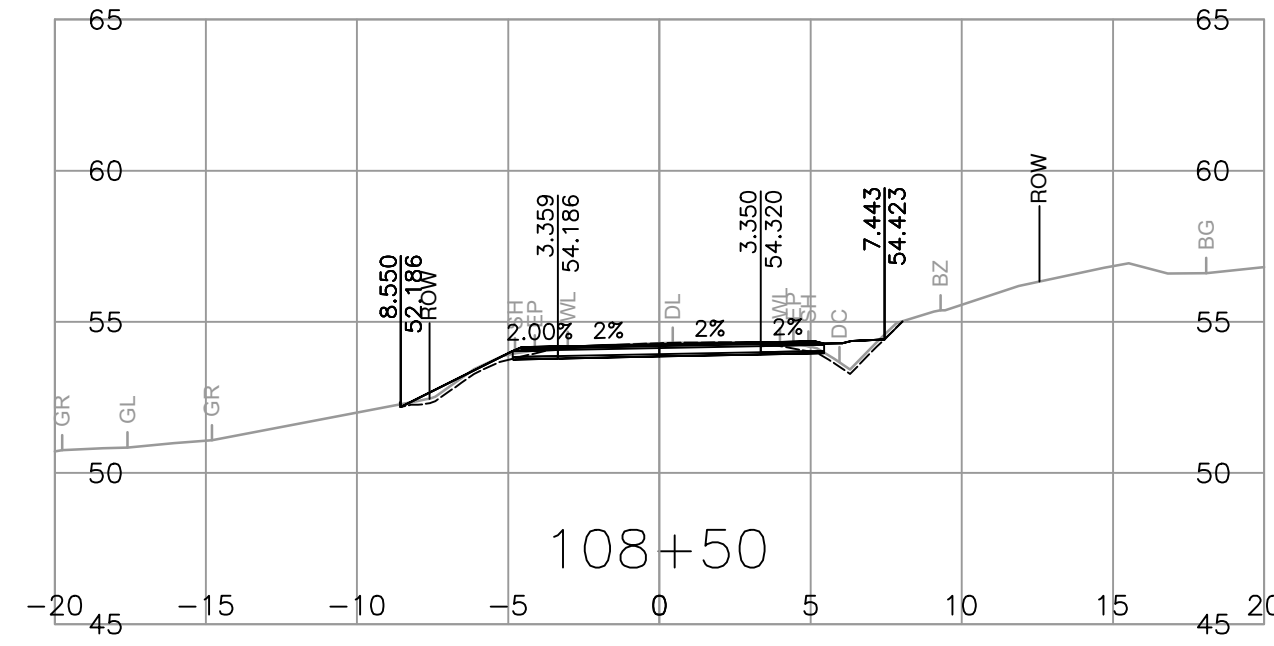
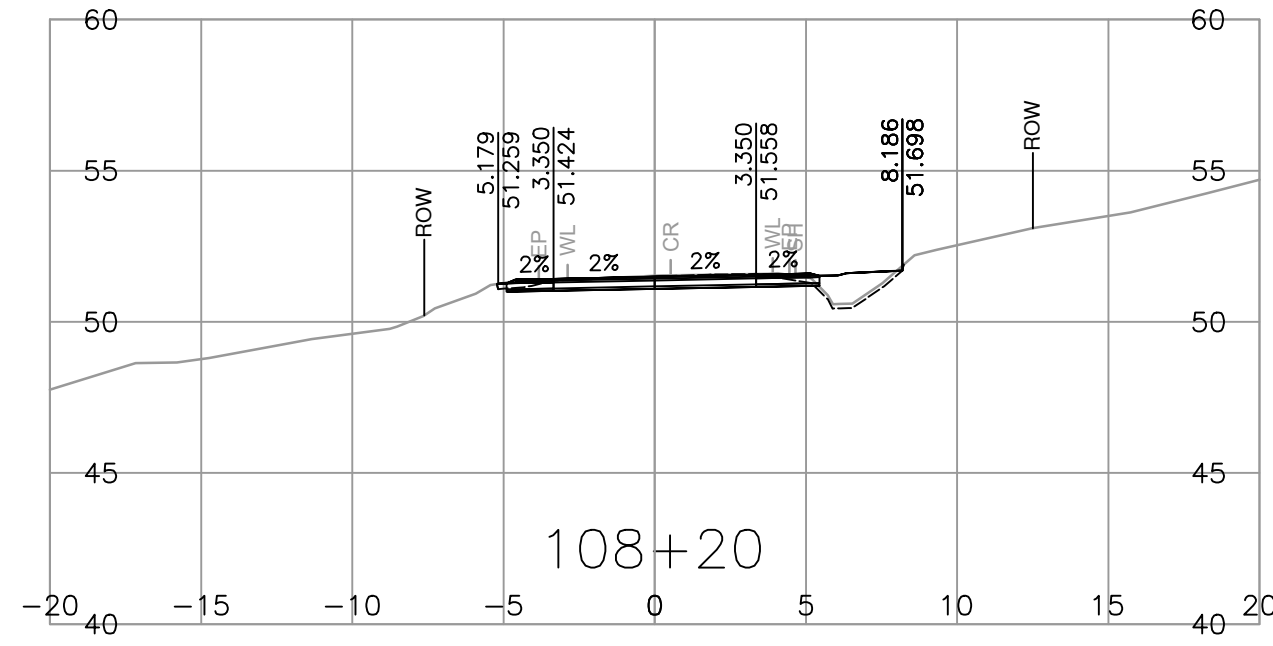
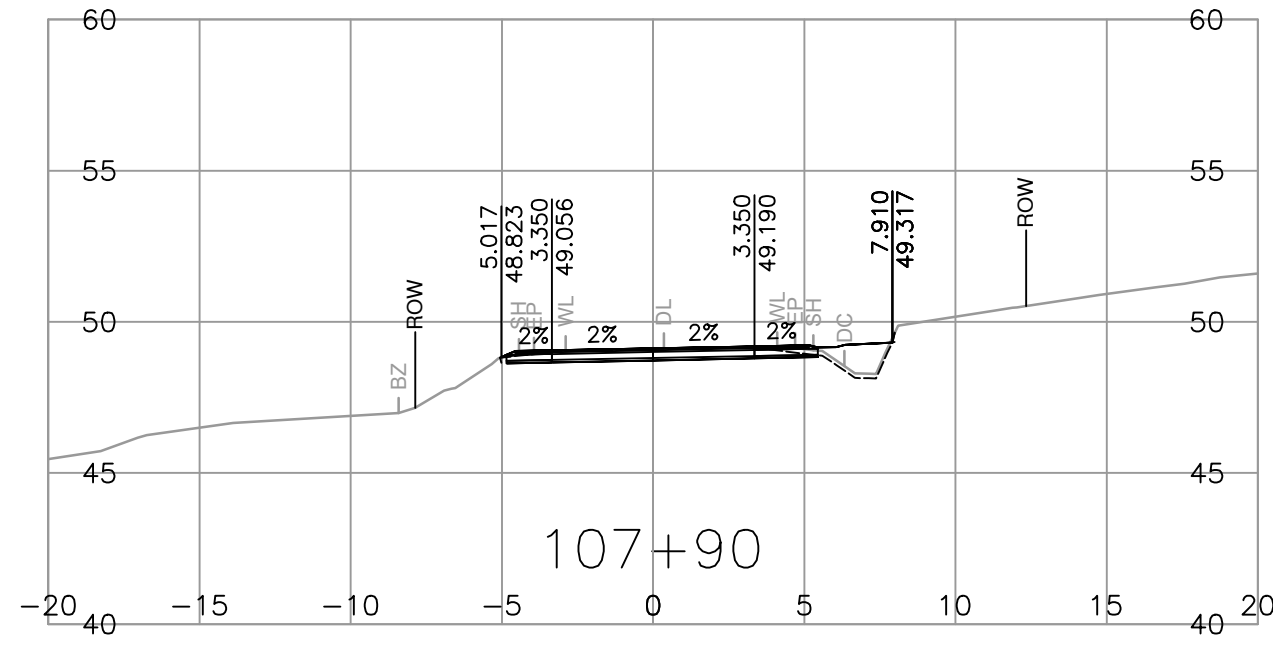

<p>SUITE 201, 8506 - 200 STREET LANGLEY, BRITISH COLUMBIA, V2Y 0M1 PH : 604.371.0091 FAX : 604.371.0098</p>	<p>SCALE 0 2 1:250 12m</p>	<p>CAD FILENAME R1-989-1000 PLOT DATE 2024-03-01</p>	<p>MINISTRY OF TRANSPORTATION AND INFRASTRUCTURE SOUTH COAST REGION VANCOUVER ISLAND DISTRICT</p>	<p>TEMPLATE CROSS SECTIONS FULFORD-GANGES ROAD IMPROVEMENT SEAVIEW AVENUE TO CRANBERRY ROAD</p>															
	<table border="1"> <thead> <tr> <th>REV</th> <th>DATE</th> <th>REVISIONS</th> <th>NAME</th> </tr> </thead> <tbody> <tr><td> </td><td> </td><td> </td><td> </td></tr> <tr><td> </td><td> </td><td> </td><td> </td></tr> <tr><td> </td><td> </td><td> </td><td> </td></tr> </tbody> </table>	REV	DATE	REVISIONS	NAME													<p>DESIGNED B. PEEBLES DATE 2024-02-01 QUALITY CONTROL Z. PENDON DATE 2024-02-01 QUALITY ASSURANCE A. SANTOS DATE 2024-02-01 DRAWN J. SHIM DATE 2024-02-01</p>	<p>FILE NUMBER 32836 PROJECT NUMBER 16873-0001 REG 1 DRAWING NUMBER R1-989-1006</p>
REV	DATE	REVISIONS	NAME																

PLOT DATE: 2024/03/01 G:\Projects\32000\32800\Fulford_Ganges_Road_Widening\02_CADD\DrawingProduction\1000_DesignSections\R1-989-1000.dwg

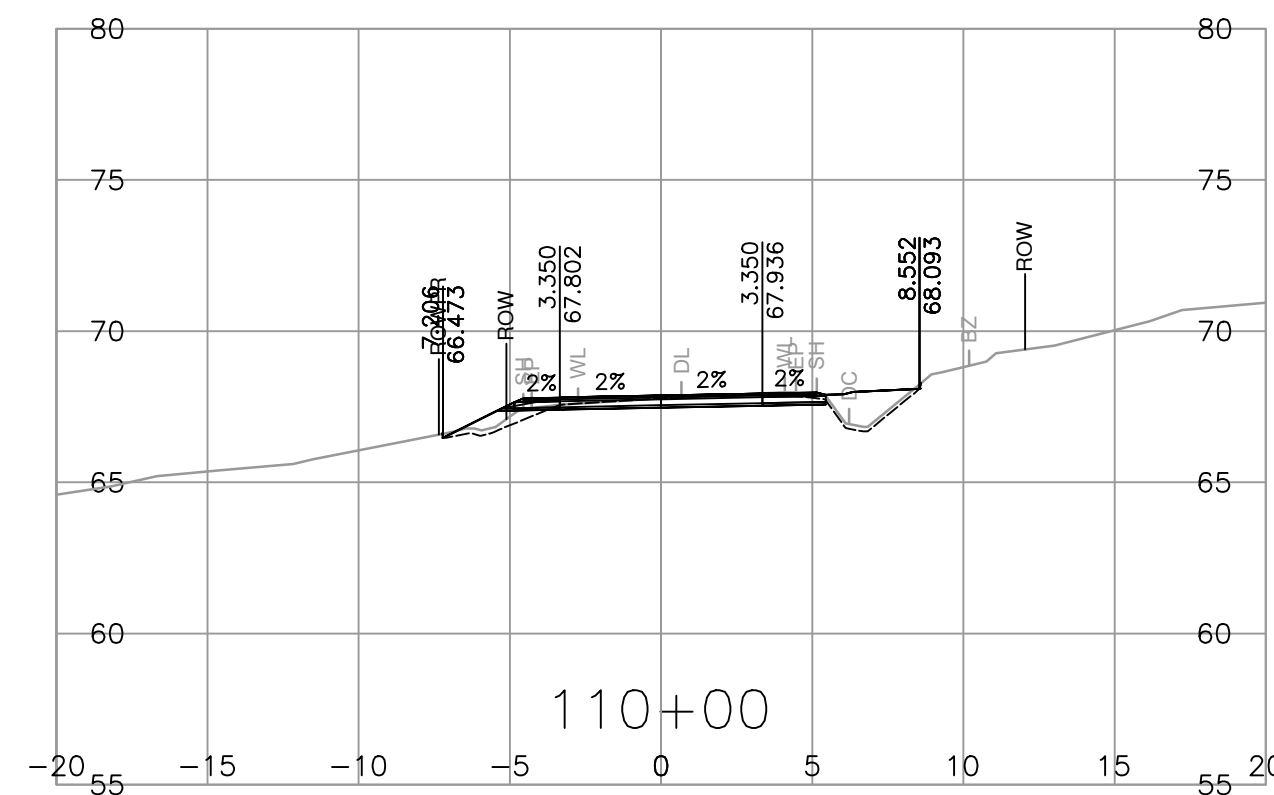
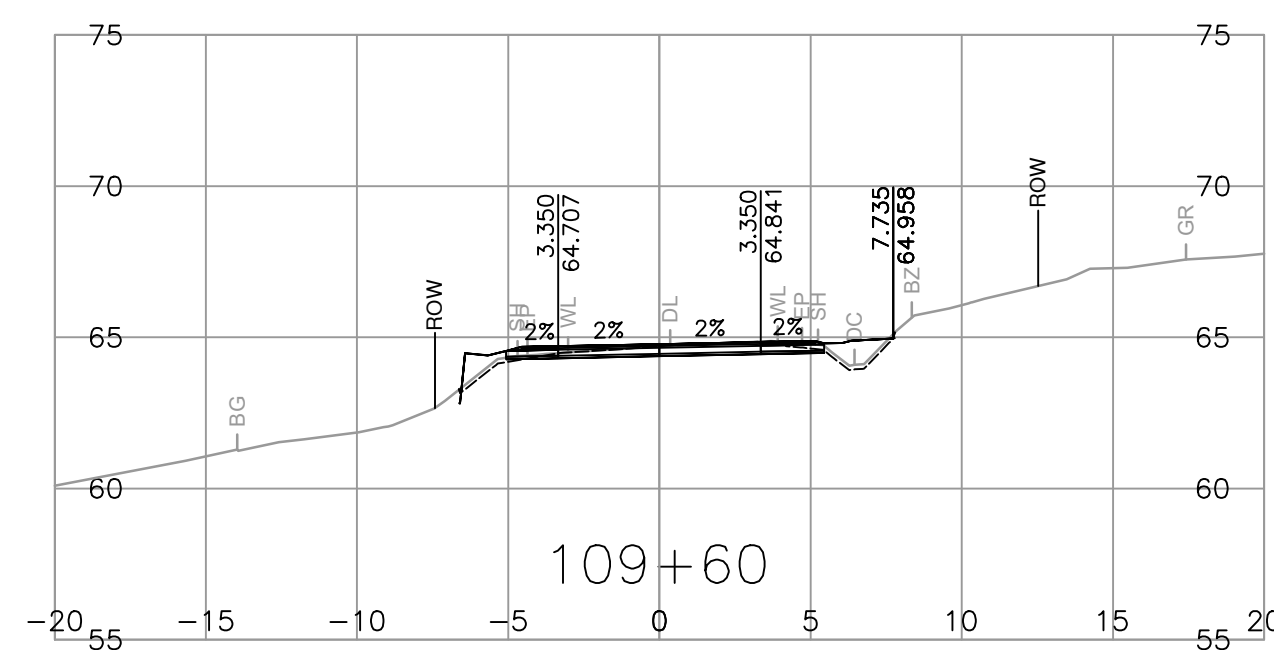
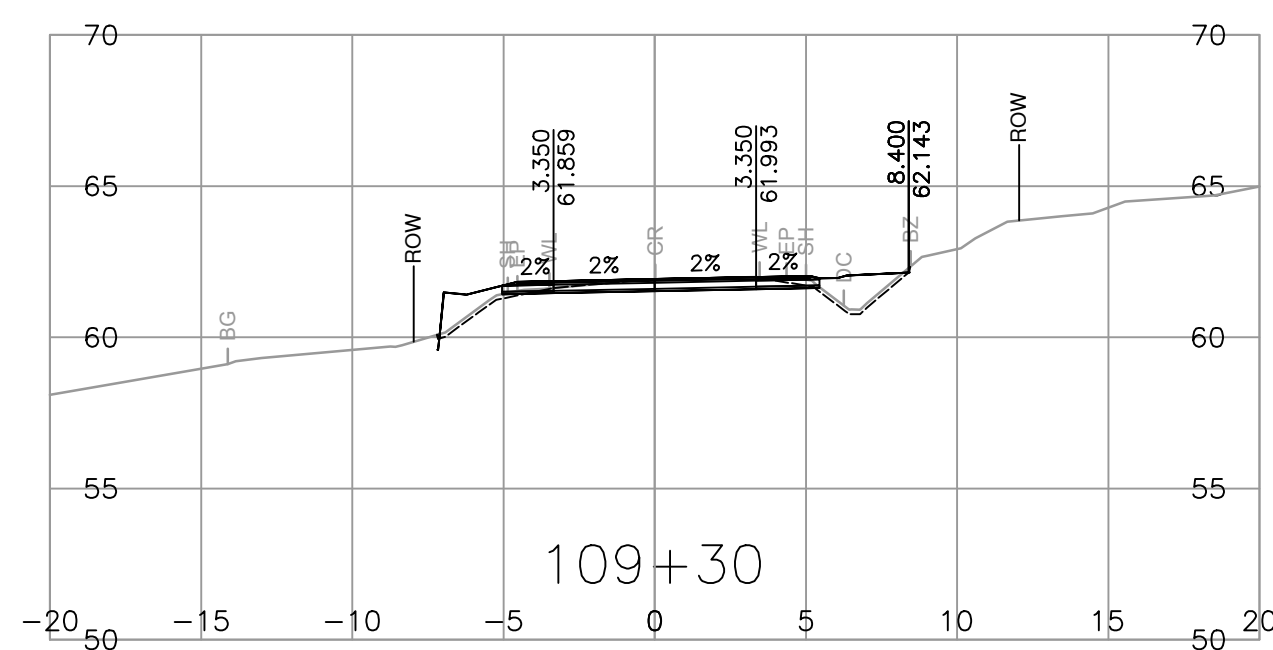
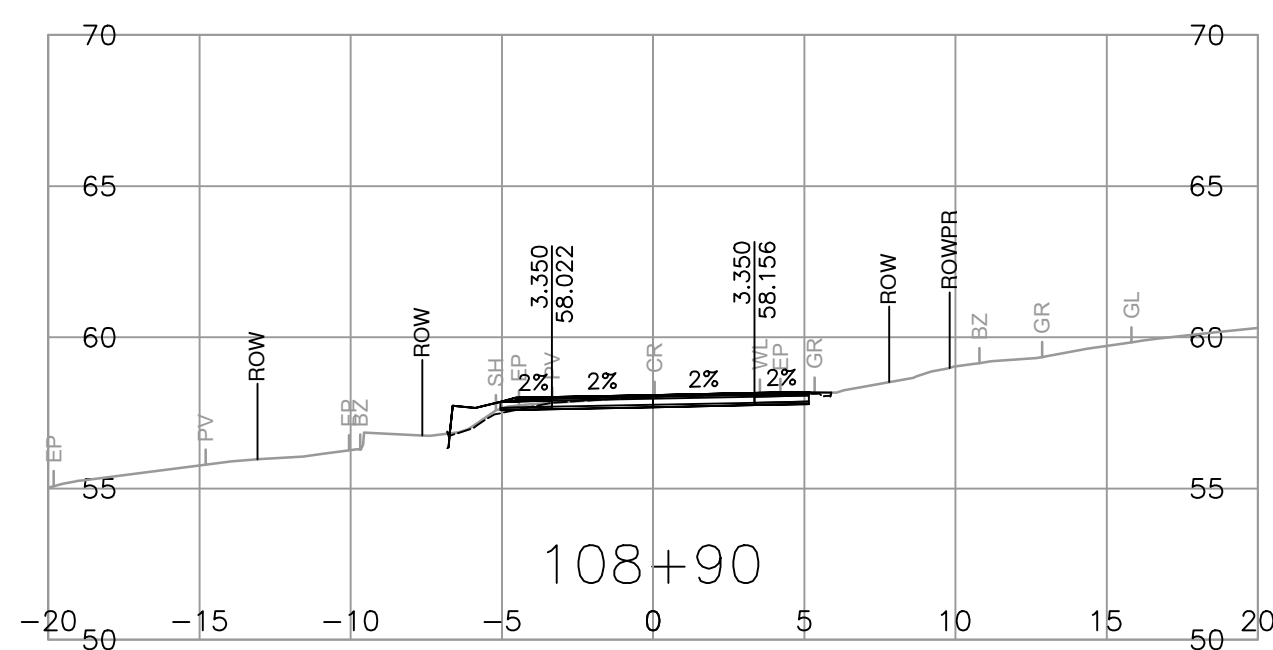
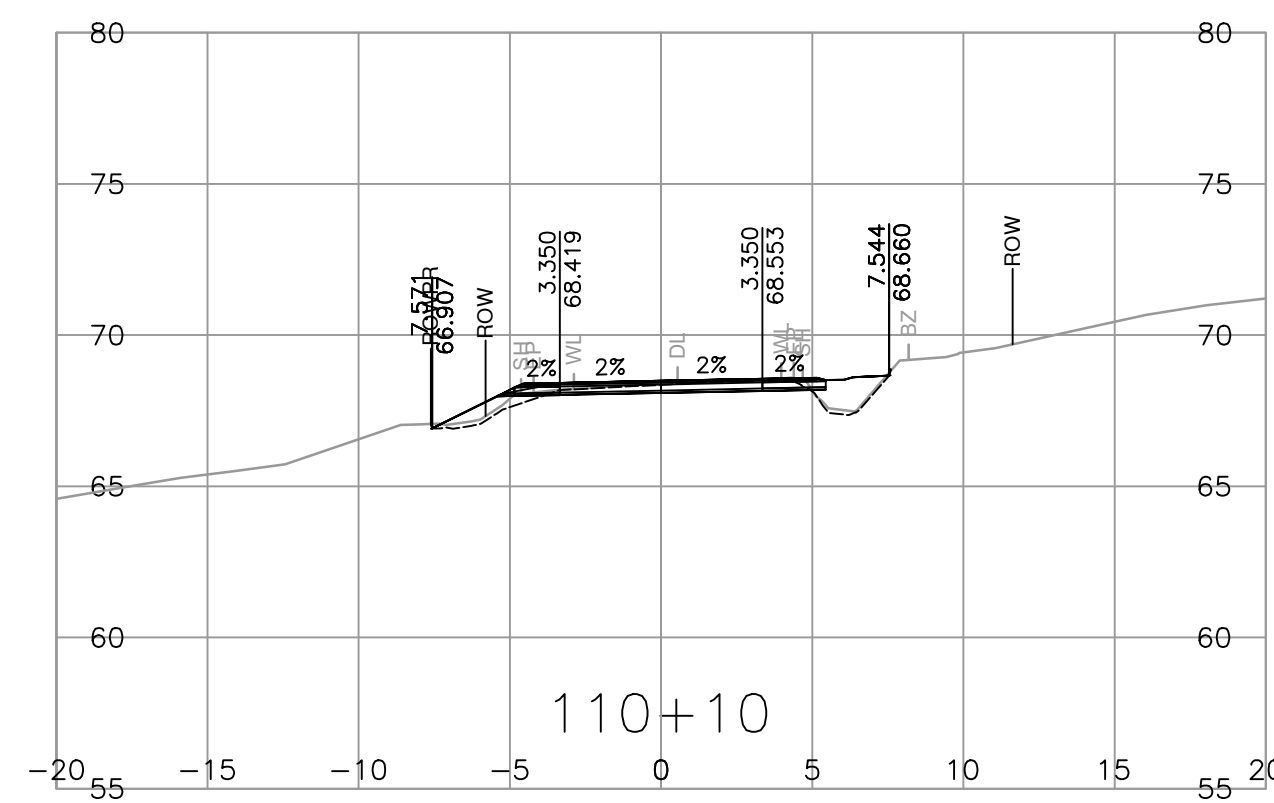
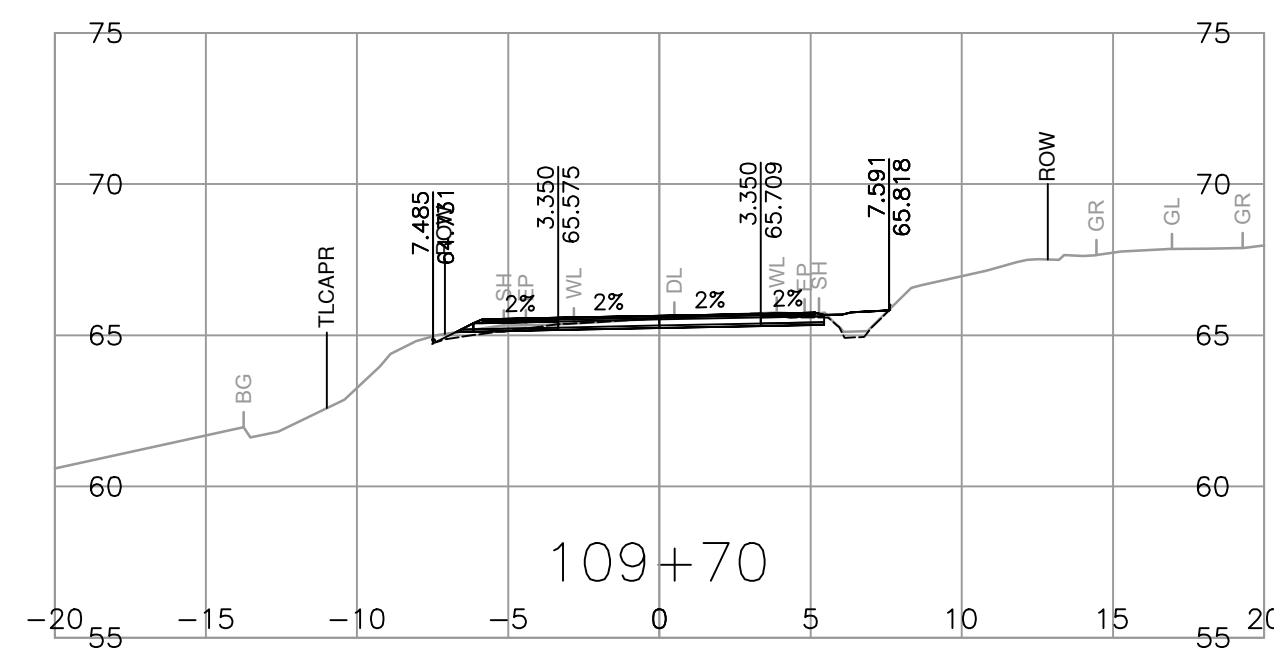
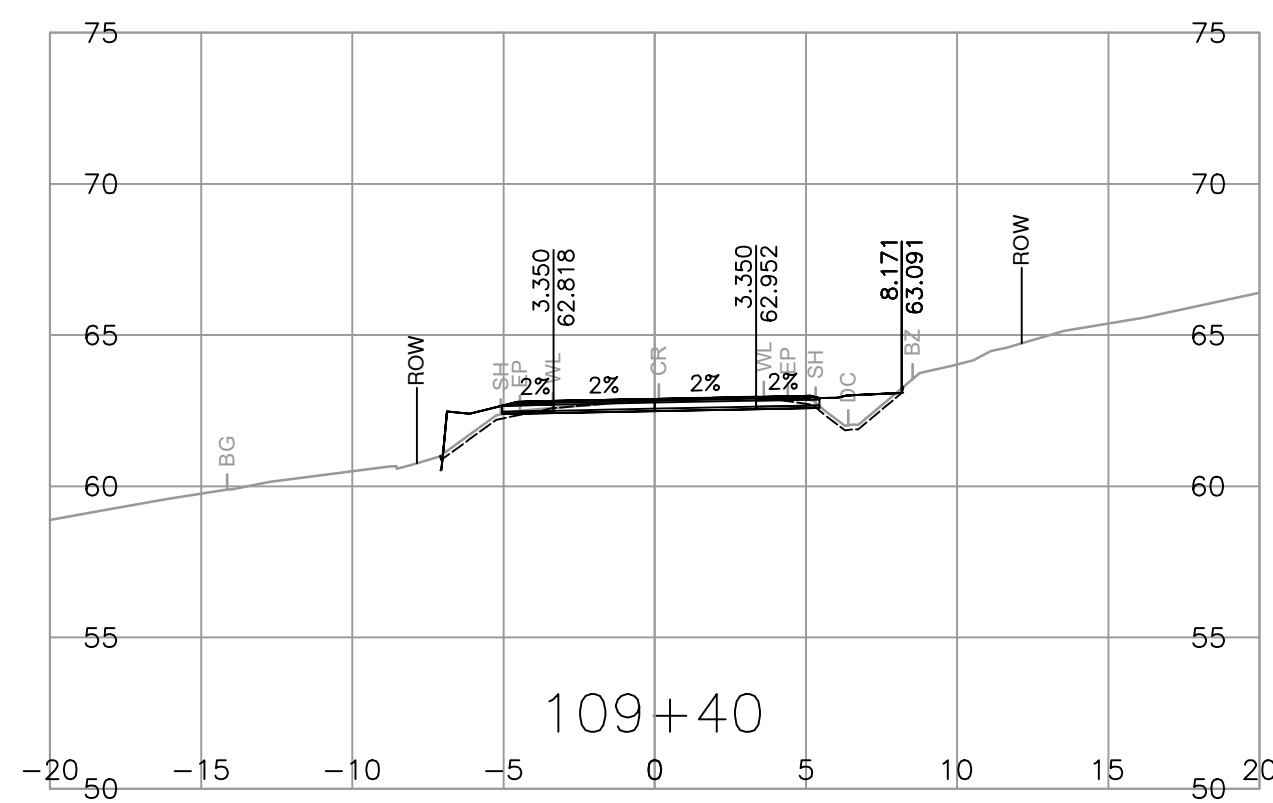
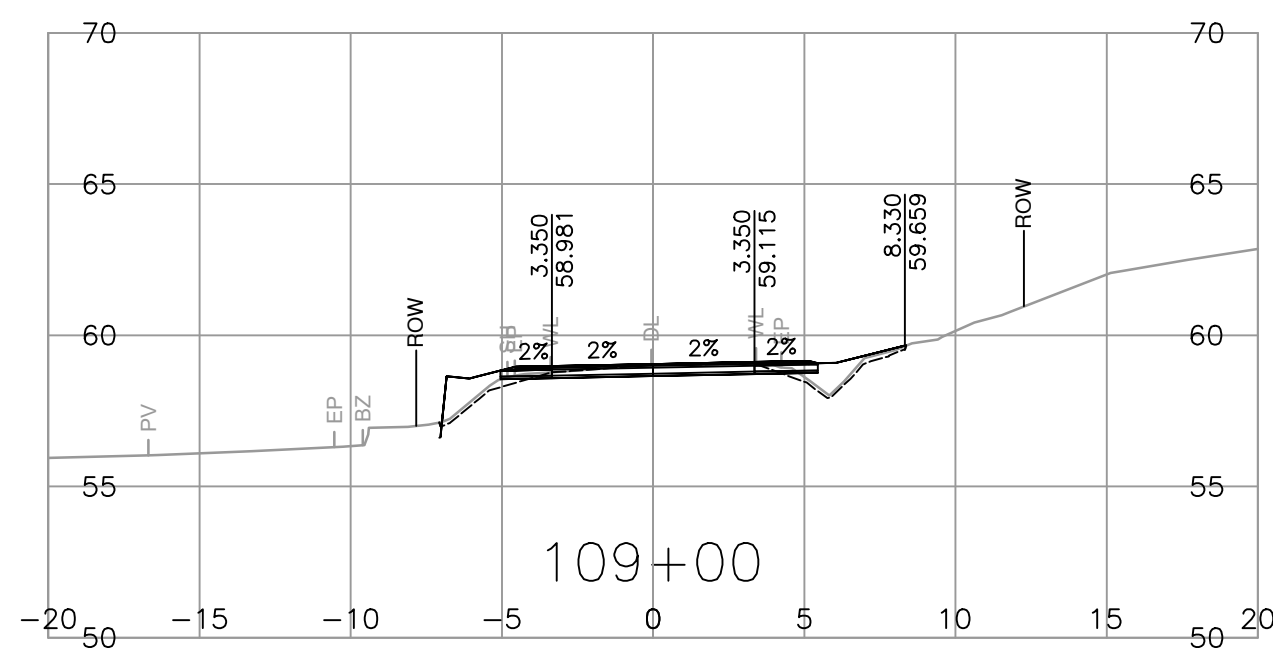
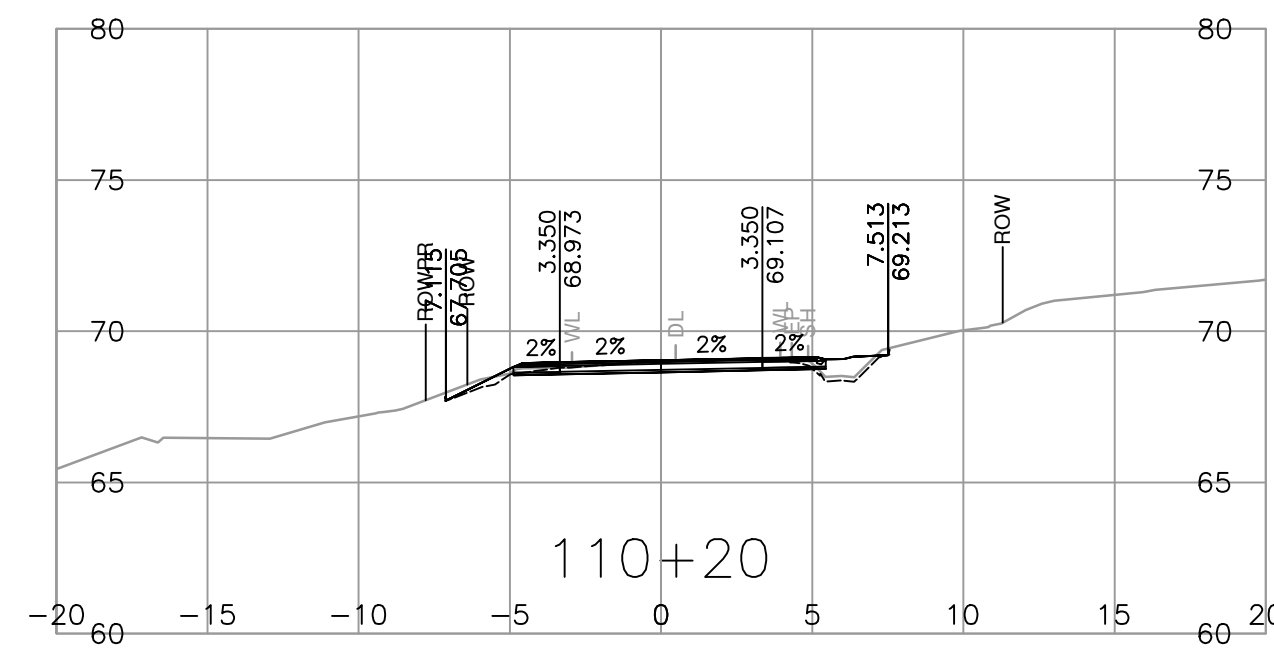
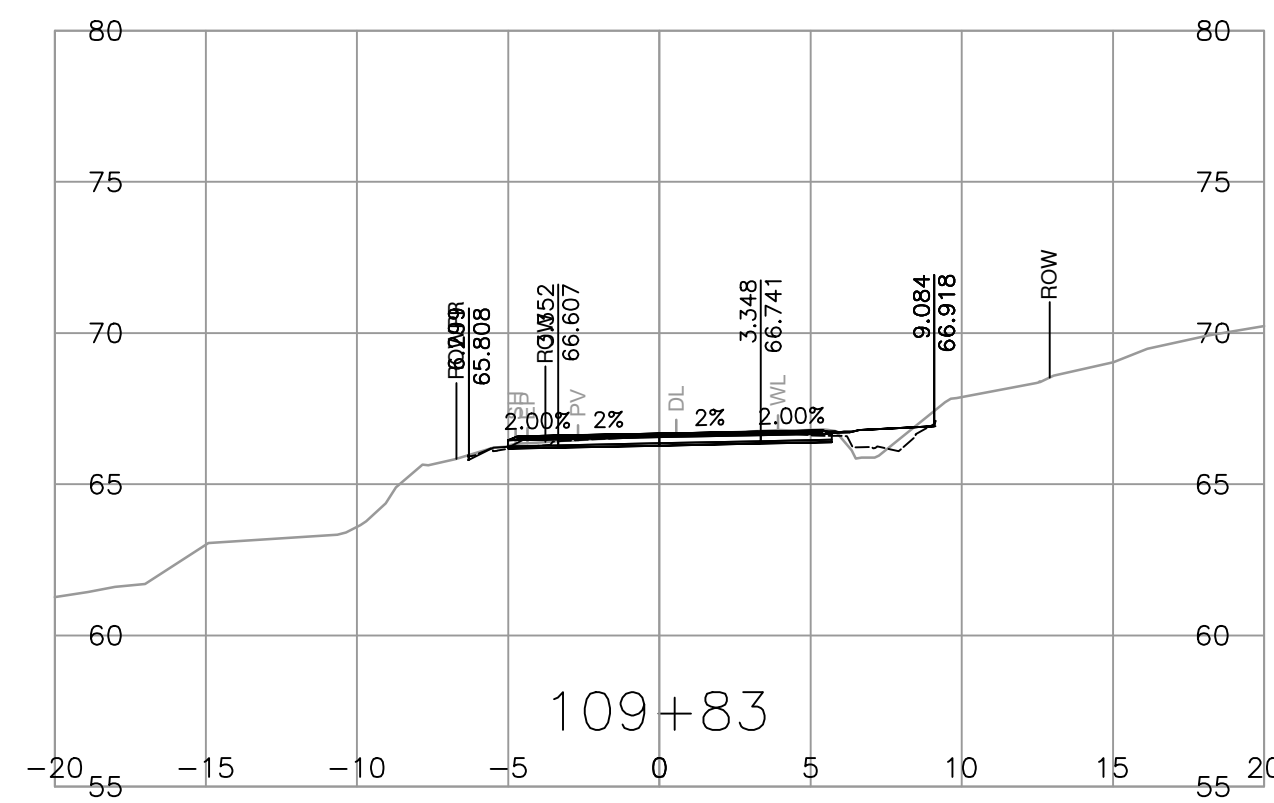
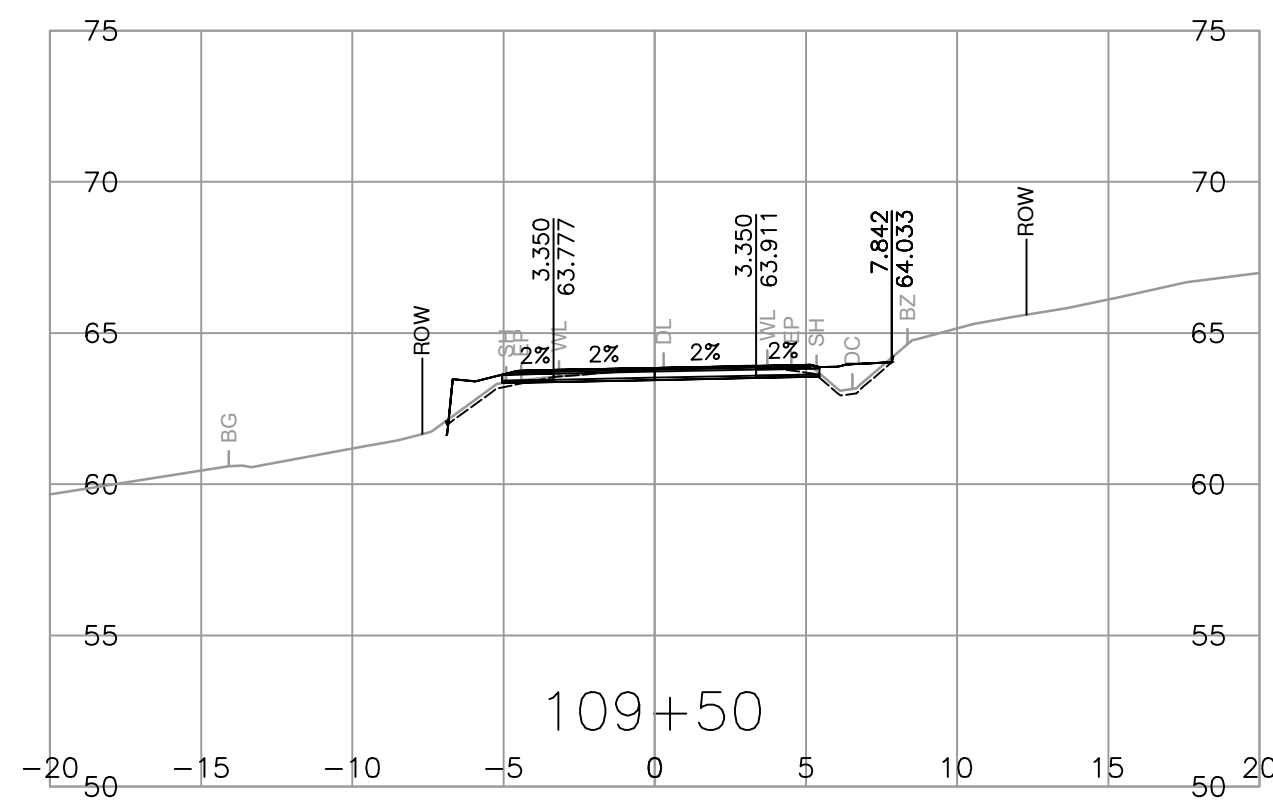
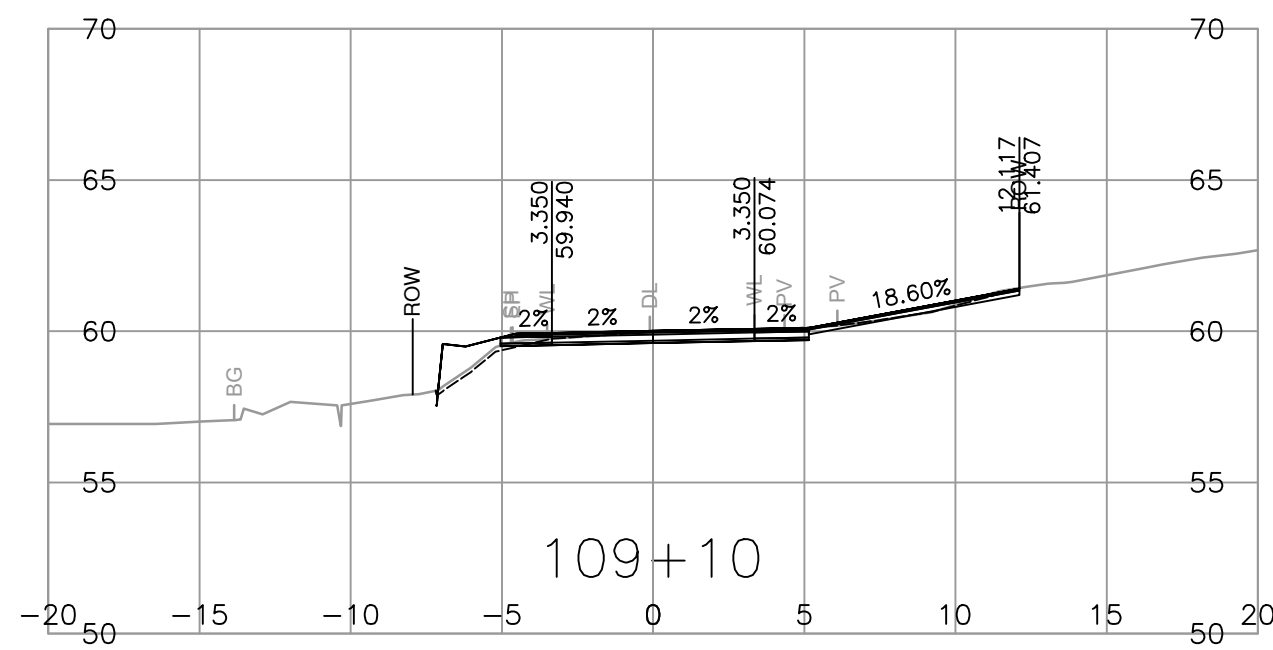
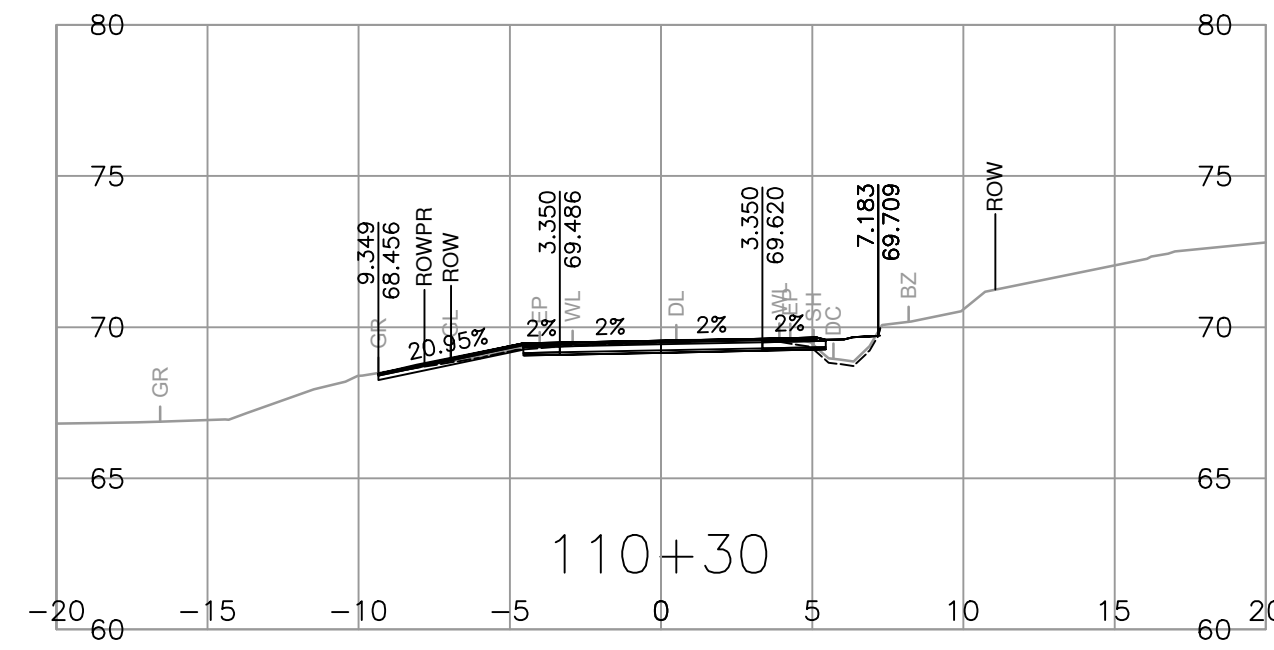
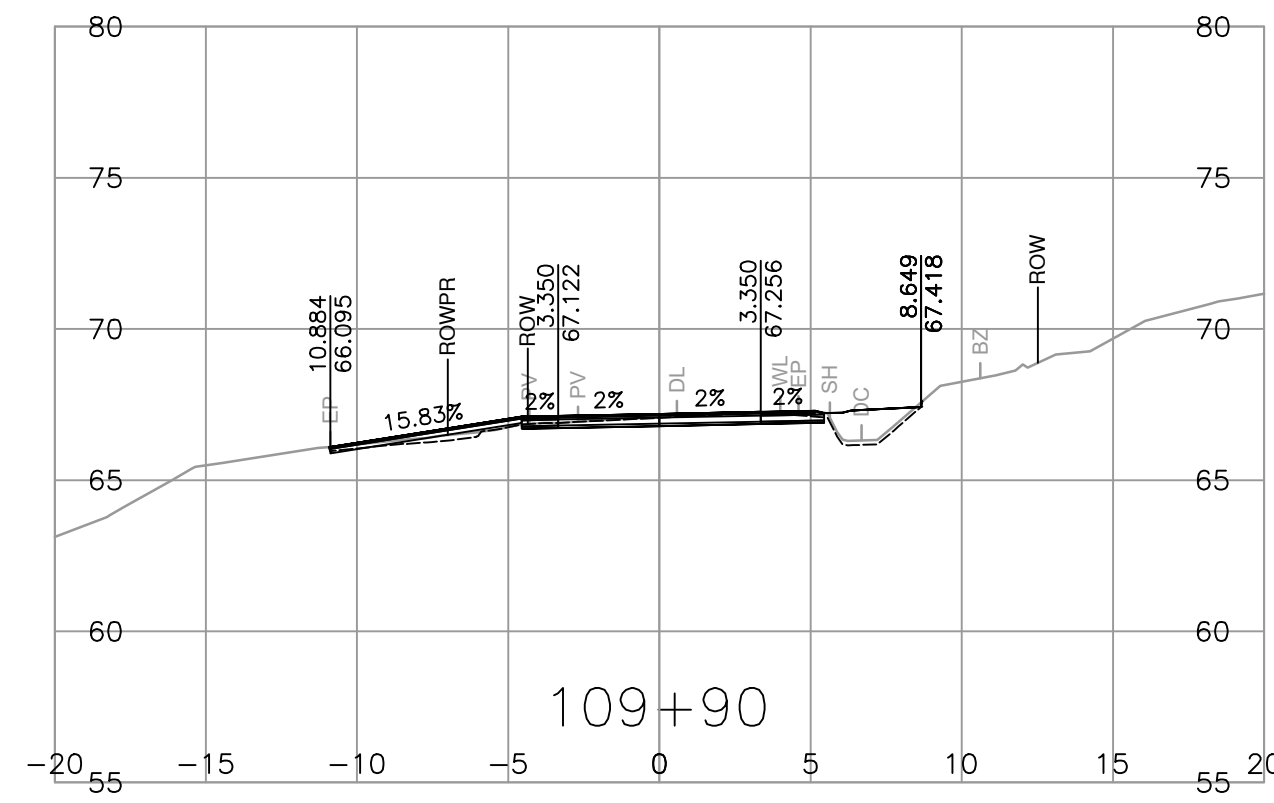
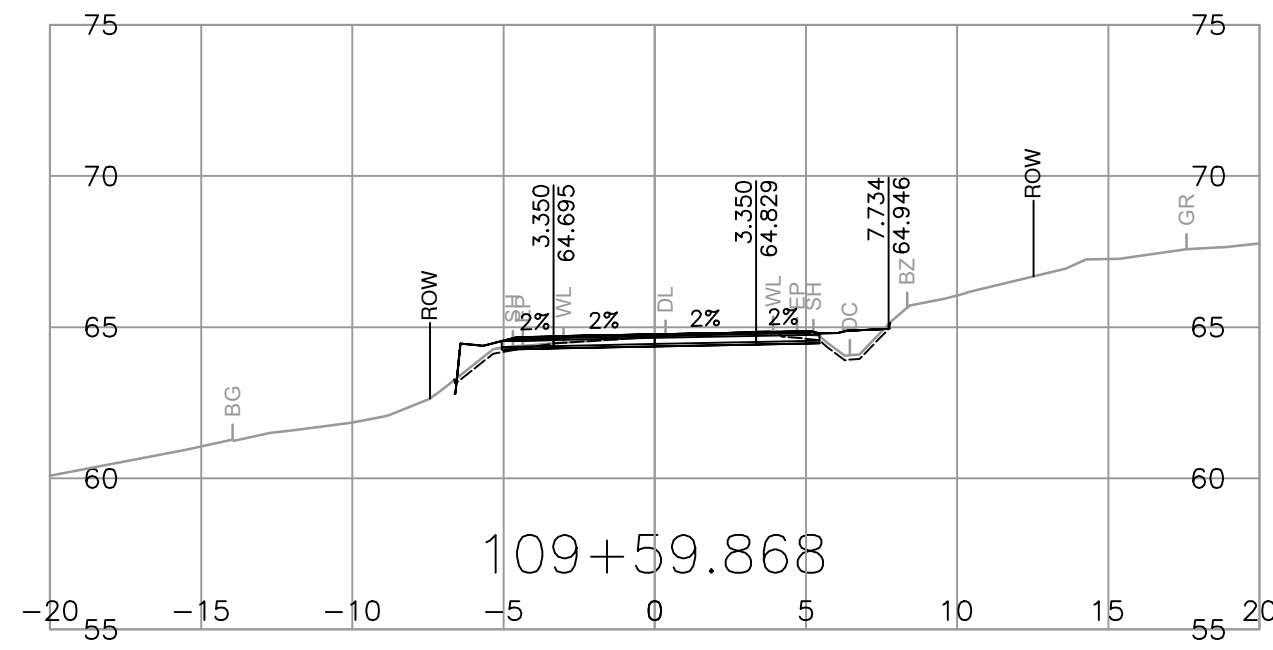
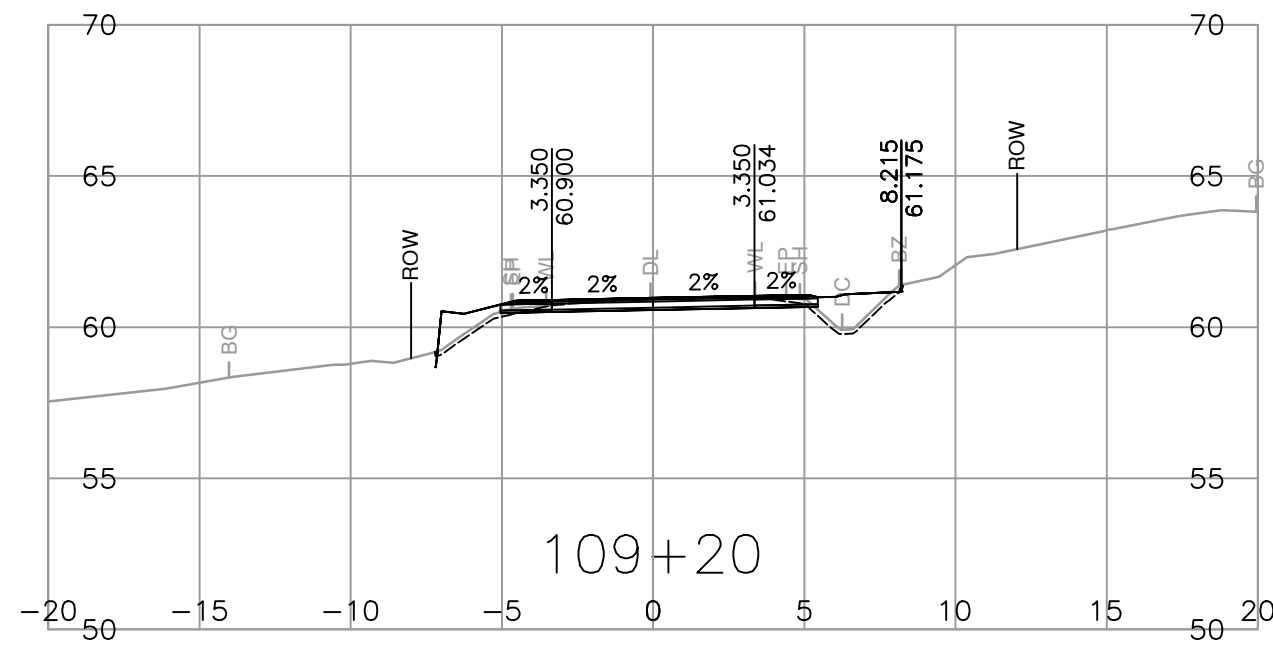

<p>SUITE 201, 8506 - 200 STREET LANGLEY, BRITISH COLUMBIA, V2Y 0M1 PH : 604.371.0091 FAX : 604.371.0098</p>	<p>SCALE 0 2 1:250 12m</p>	<p>CAD FILENAME R1-989-1000 PLOT DATE 2024-03-01</p>	<p>MINISTRY OF TRANSPORTATION AND INFRASTRUCTURE SOUTH COAST REGION VANCOUVER ISLAND DISTRICT</p>	<p>DESIGNED B. PEEBLES DATE 2024-02-01 QUALITY CONTROL Z. PENDON DATE 2024-02-01 QUALITY ASSURANCE A. SANTOS DATE 2024-02-01 DRAWN J. SHIM DATE 2024-02-01</p>	<p>FILE NUMBER 32836 PROJECT NUMBER 16873-0001 REG 1 DRAWING NUMBER R1-989-1007</p>										
	<table border="1"> <thead> <tr> <th>REV</th> <th>DATE</th> <th>REVISIONS</th> <th>NAME</th> </tr> </thead> <tbody> <tr> <td> </td> <td> </td> <td> </td> <td> </td> </tr> <tr> <td> </td> <td> </td> <td> </td> <td> </td> </tr> </tbody> </table>	REV	DATE	REVISIONS	NAME									<p>SENIOR DESIGNER _____ DATE _____</p>	<p>L100</p>
REV	DATE	REVISIONS	NAME												

PLOT DATE: 2024/03/01 G:\Projects\32000\32800\Fulford_Ganges_Road_Widening\02_CADD\DrawingProduction\1000_DesignSections\R1-989-1000.dwg

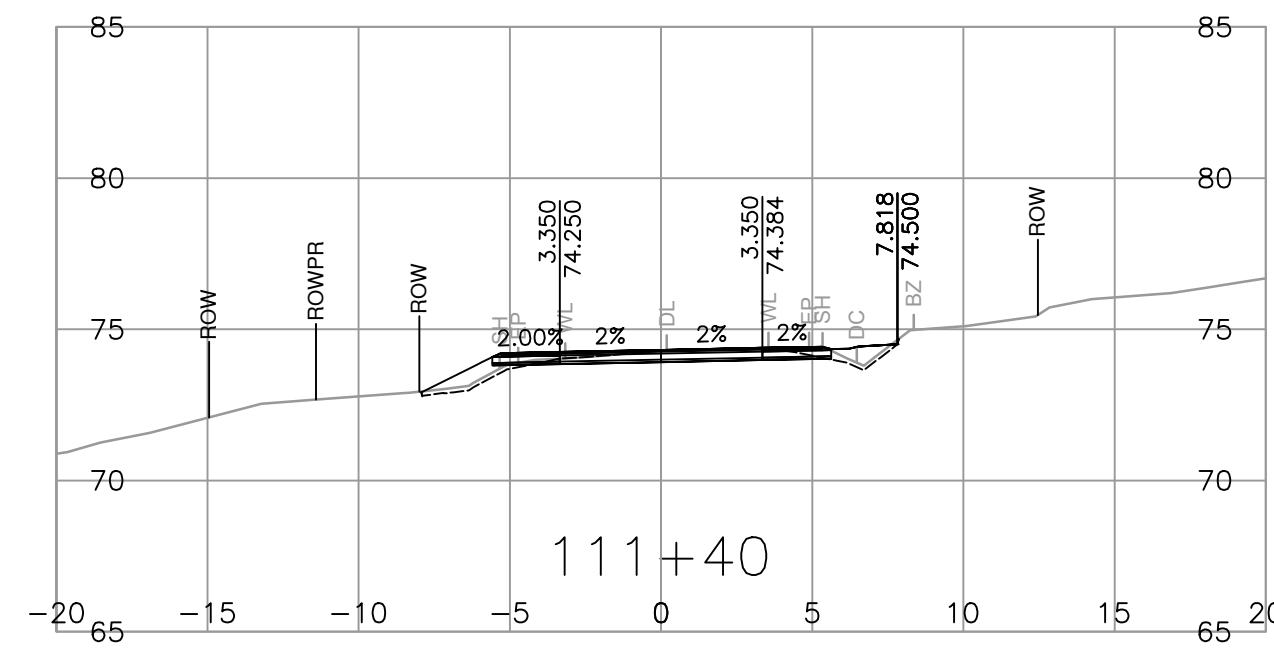
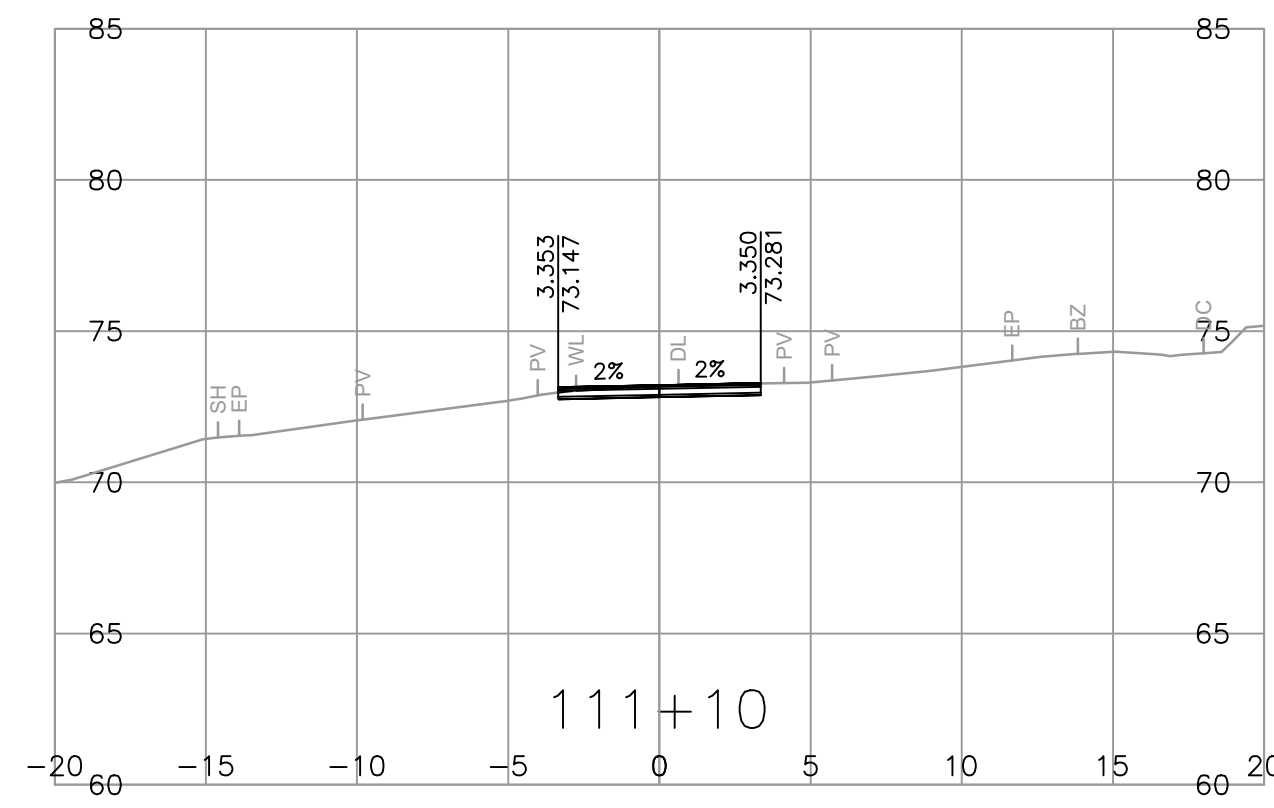
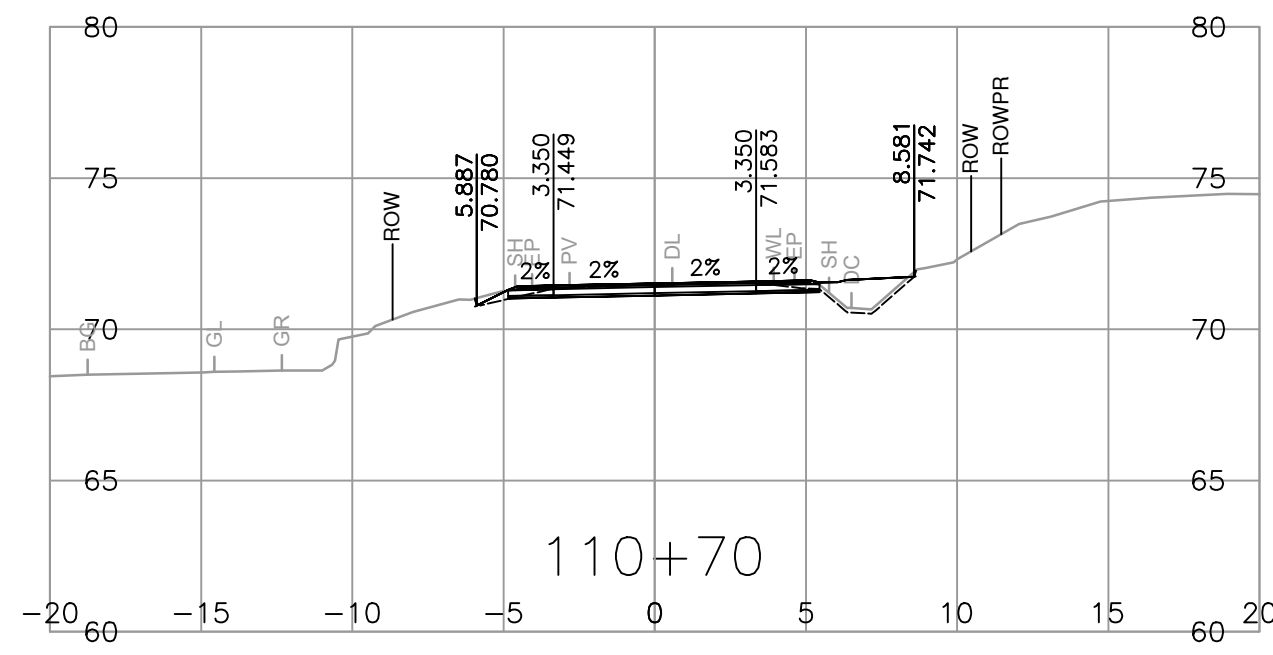
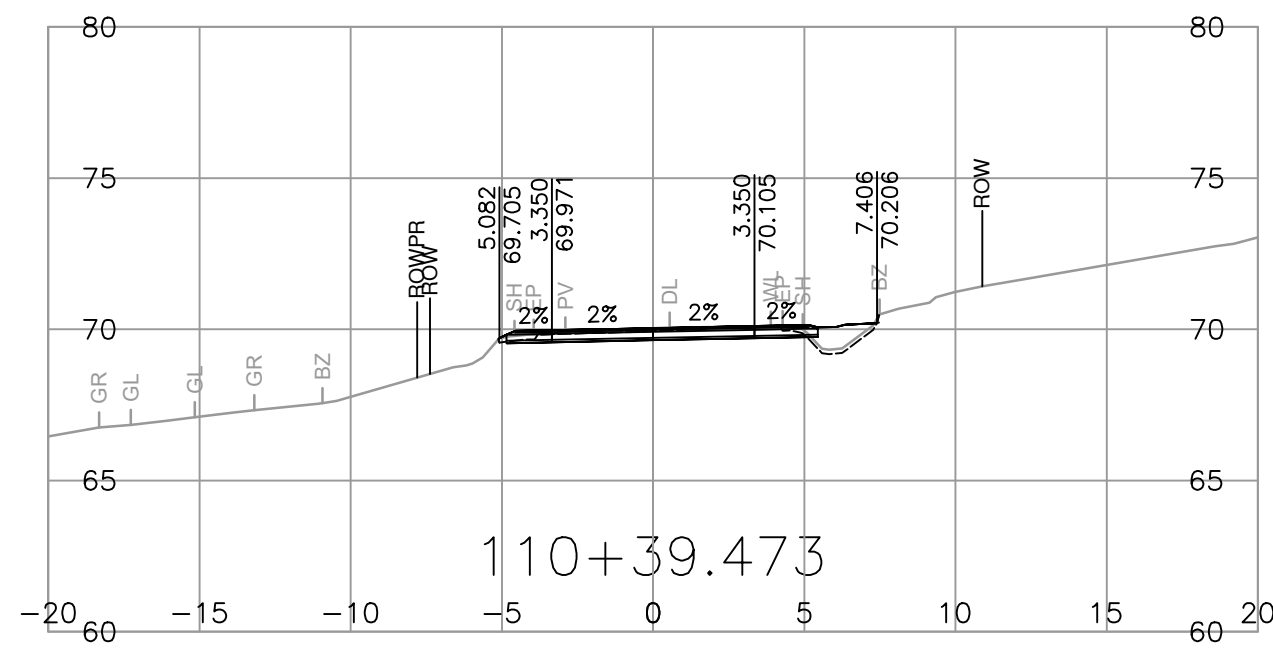
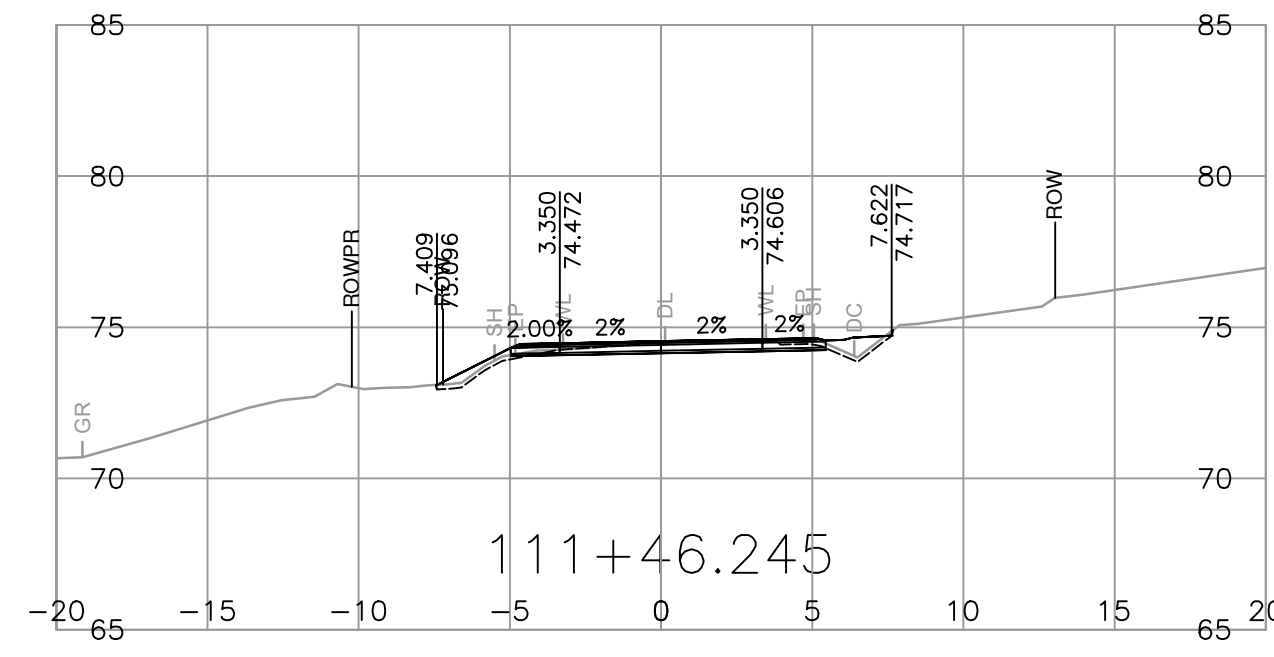
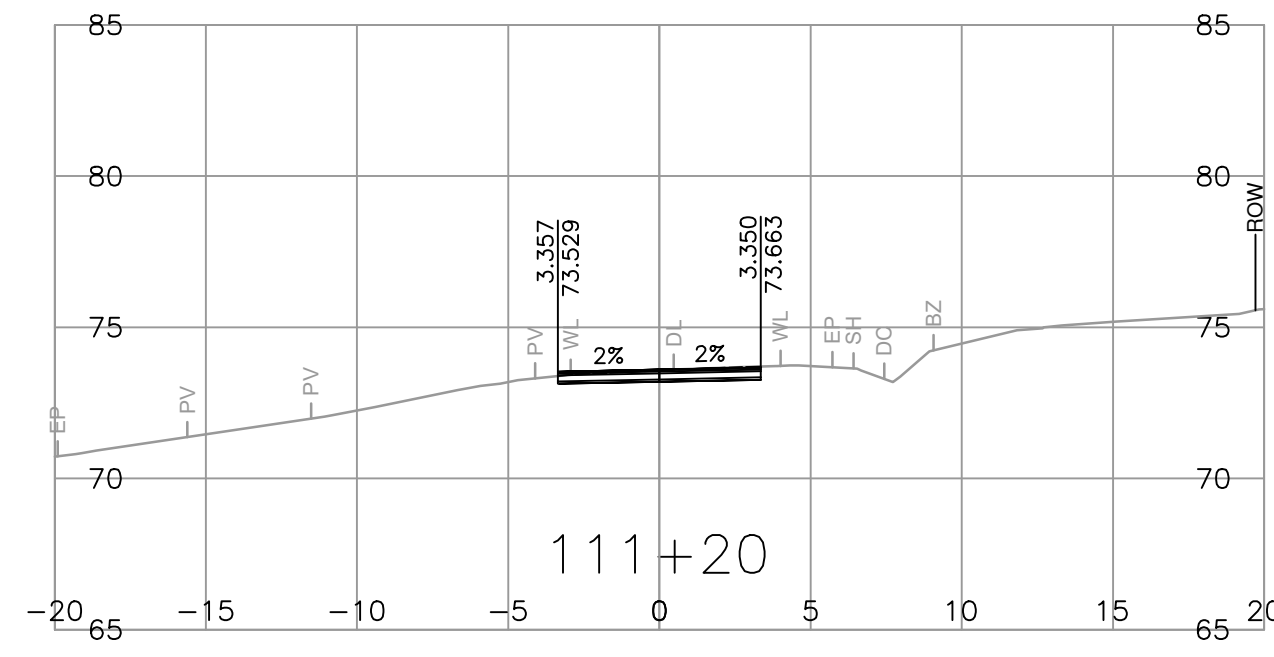
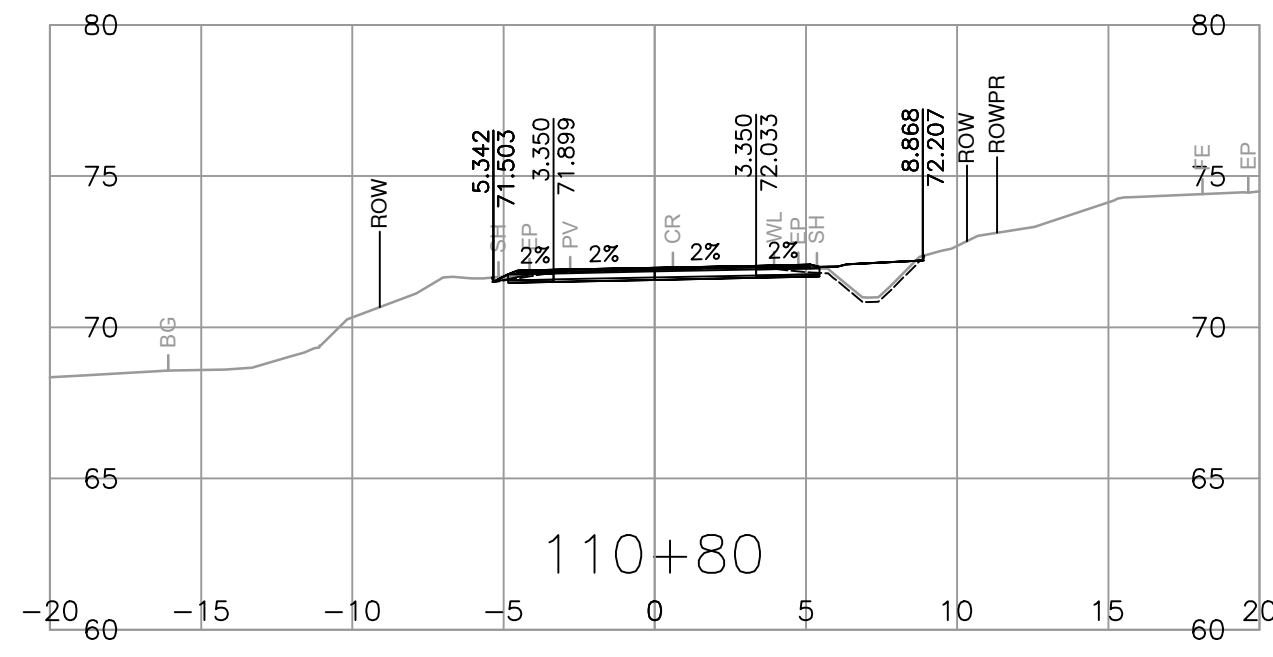
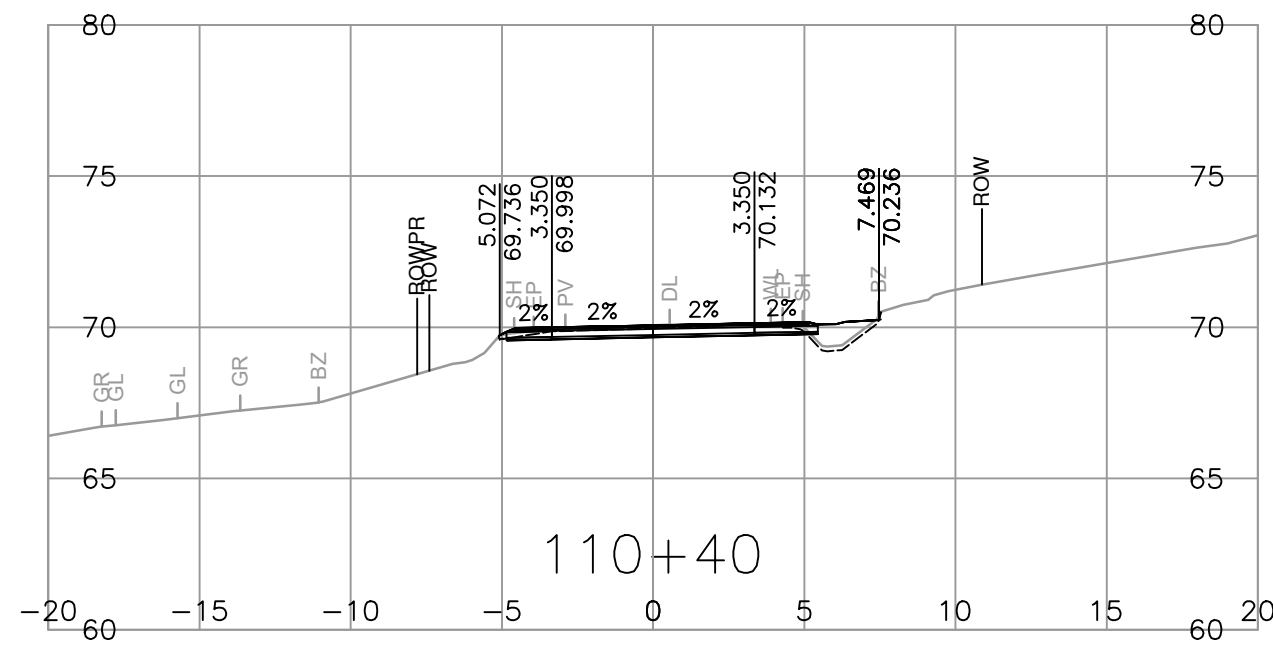
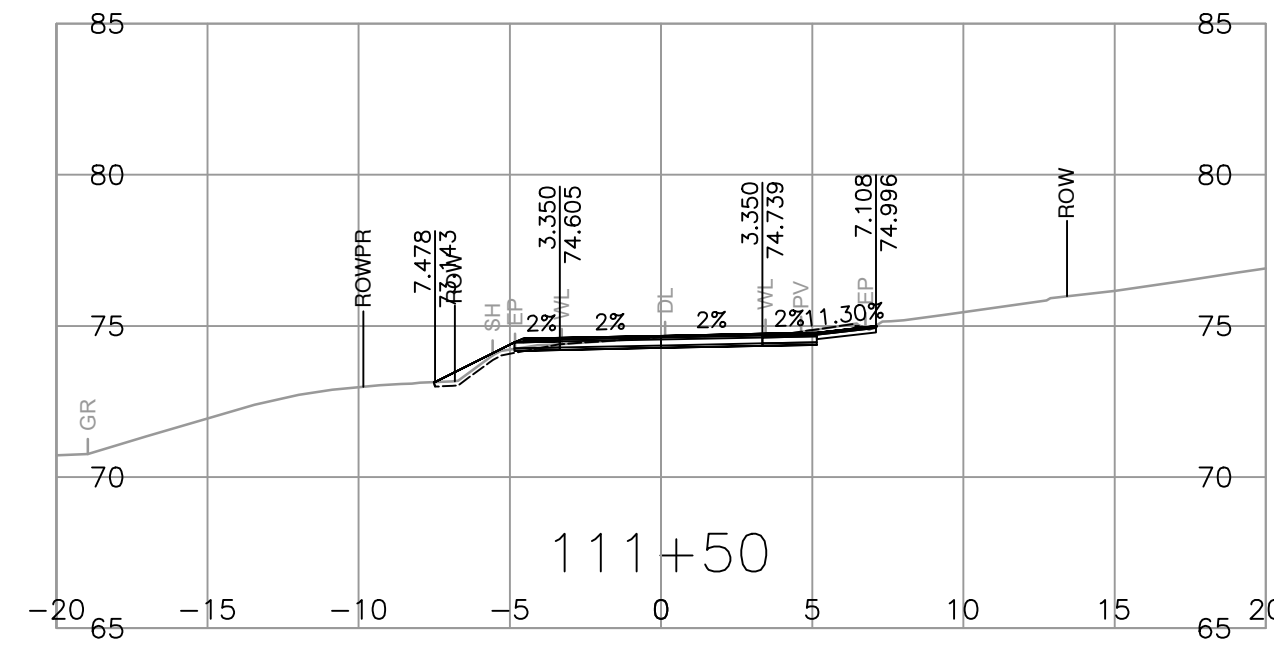
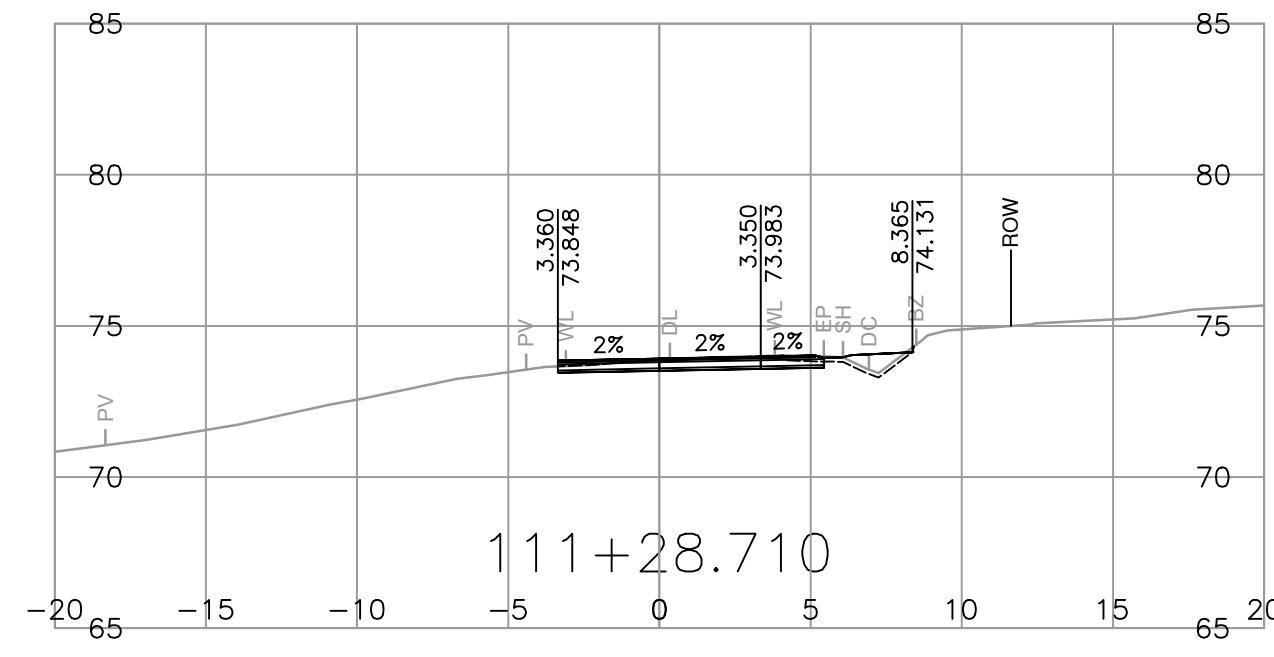
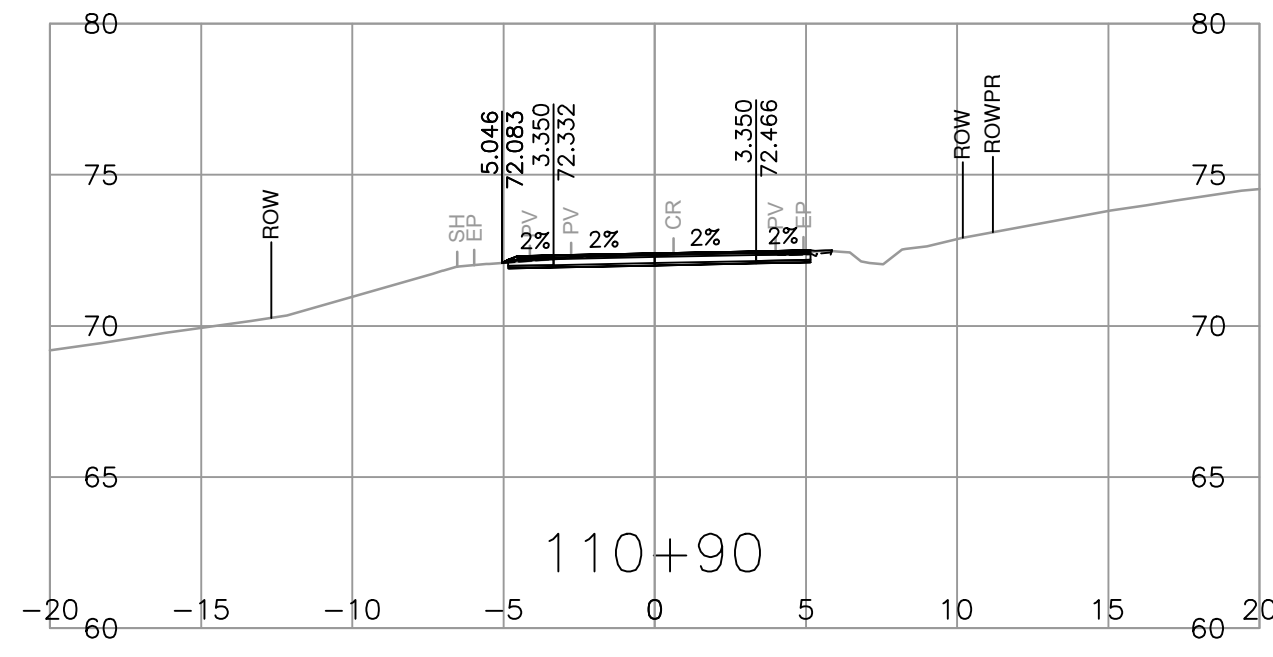
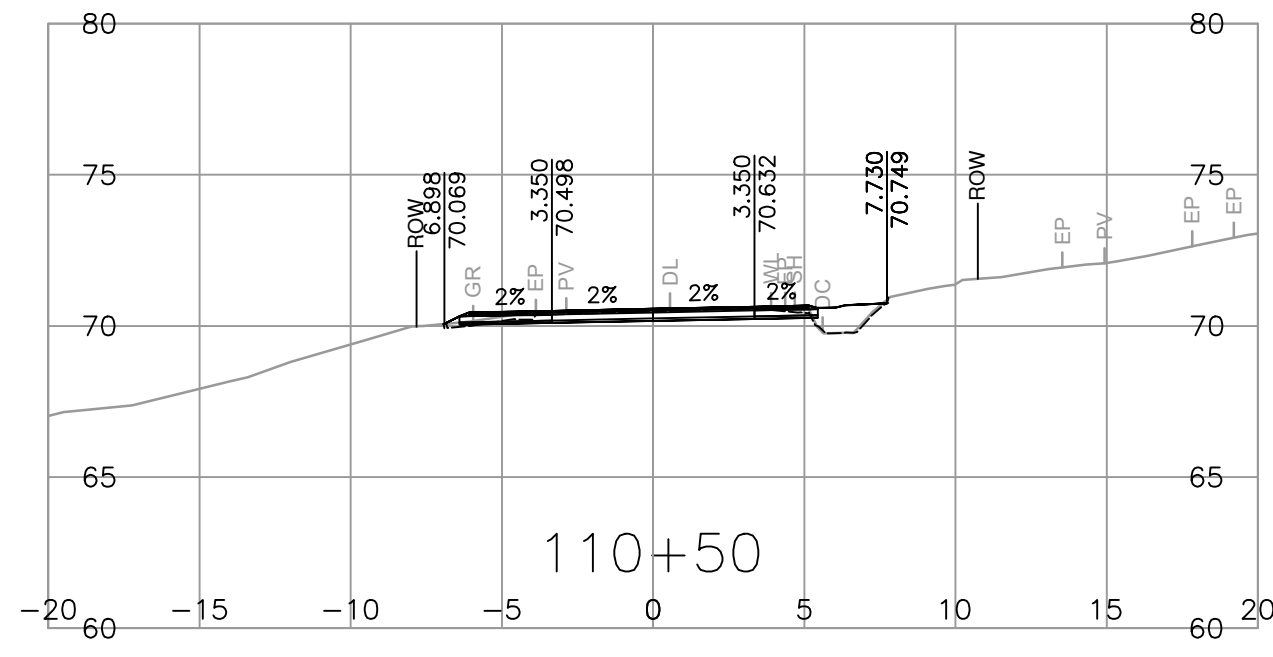
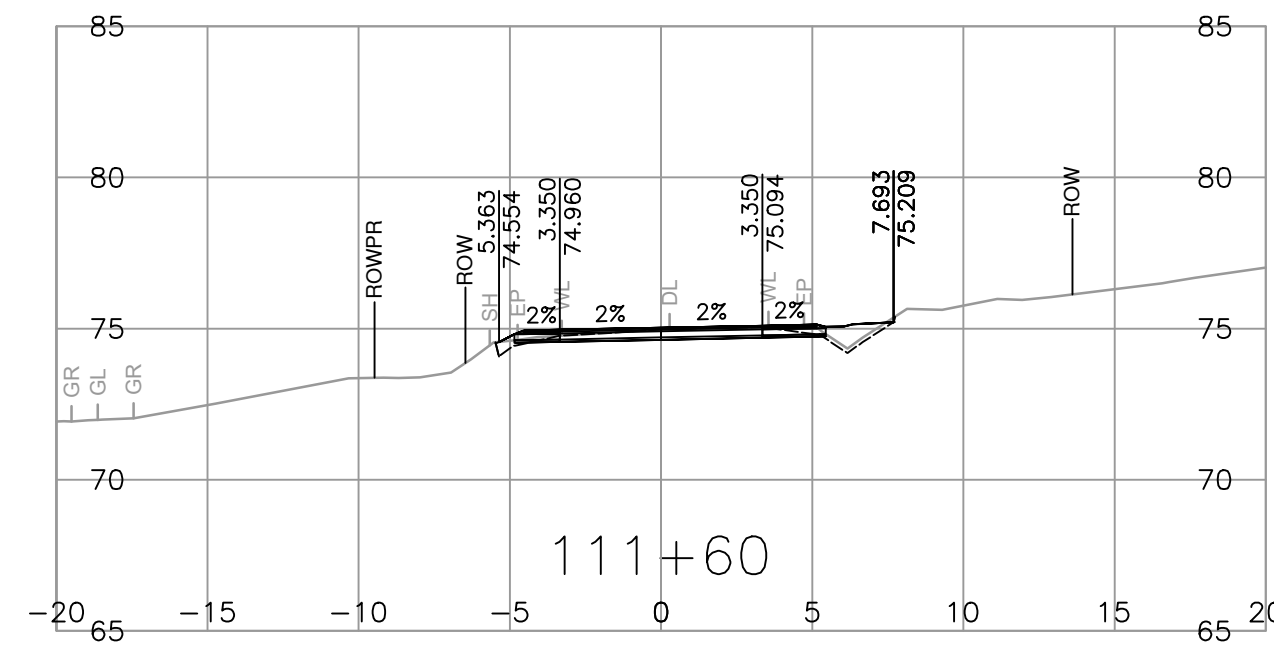
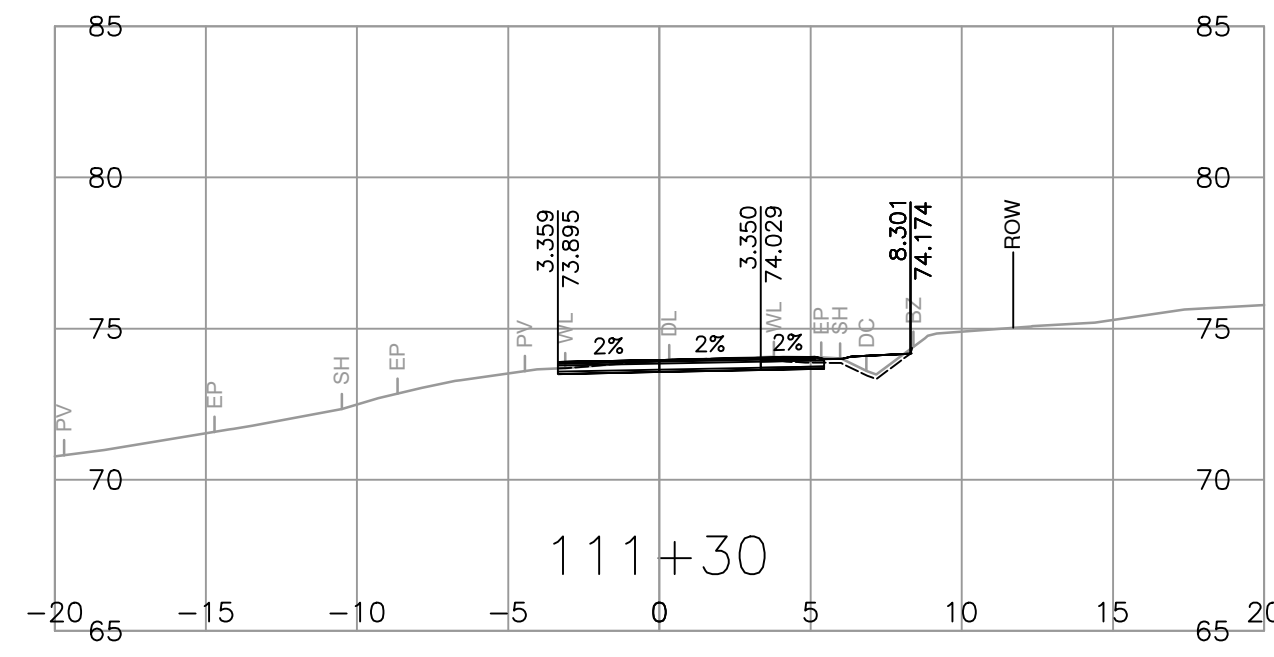
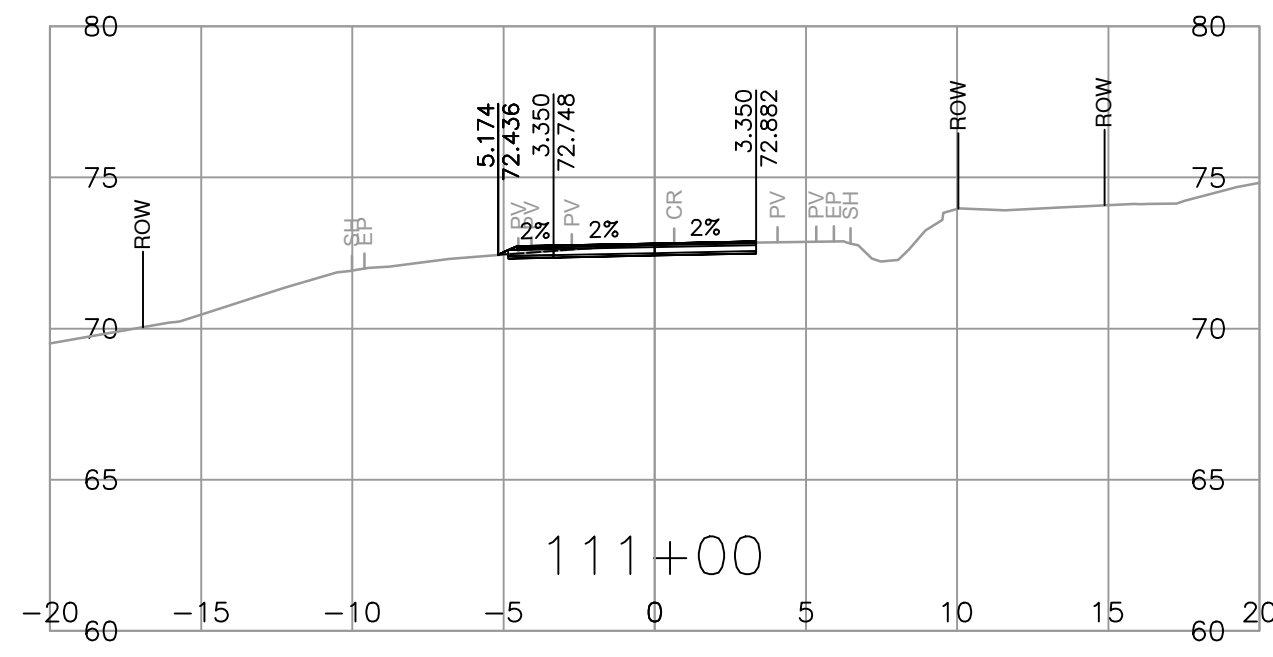
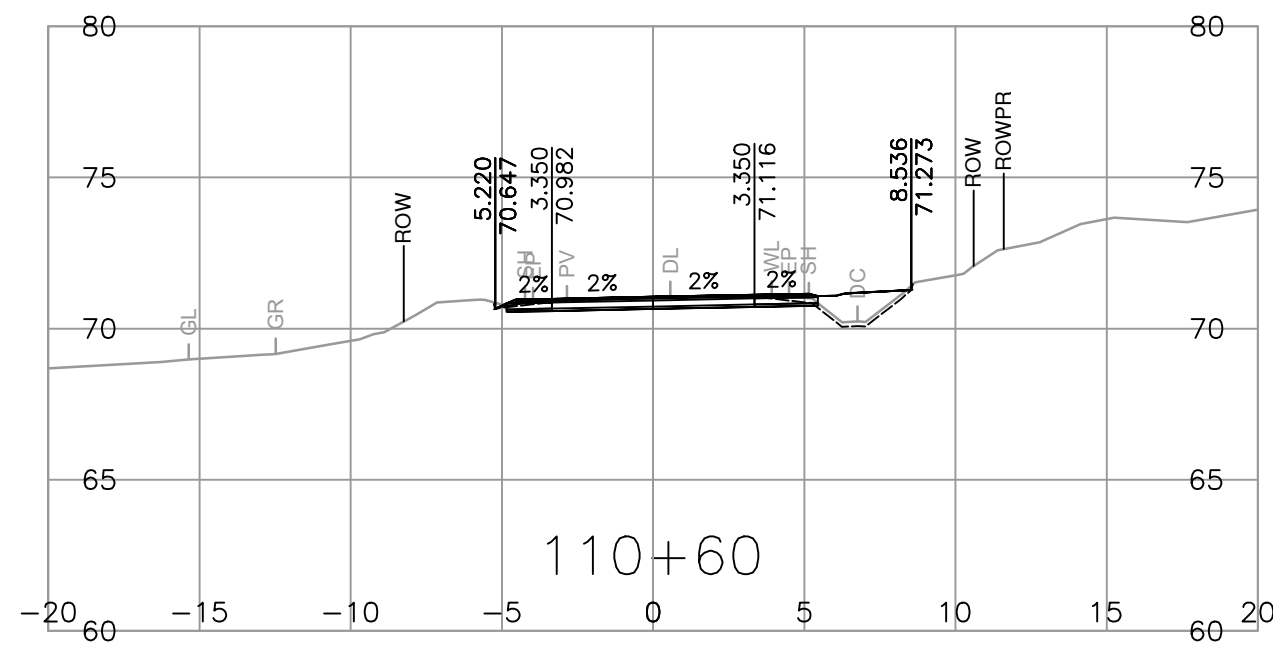

<p>SUITE 201, 8506 - 200 STREET LANGLEY, BRITISH COLUMBIA, V2Y 0M1 PH : 604.371.0091 FAX : 604.371.0098</p>	<p>SCALE </p>	<p>CAD FILENAME: R1-989-1000 PLOT DATE: 2024-03-01</p>	<p>MINISTRY OF TRANSPORTATION AND INFRASTRUCTURE SOUTH COAST REGION VANCOUVER ISLAND DISTRICT</p>	<p>DESIGNED: B. PEEBLES DATE: 2024-02-01 QUALITY CONTROL: Z. PENDON DATE: 2024-02-01 QUALITY ASSURANCE: A. SANTOS DATE: 2024-02-01 DRAWN: J. SHIM DATE: 2024-02-01</p>	<p>TEMPLATE CROSS SECTIONS FULFORD-GANGES ROAD IMPROVEMENT SEAVIEW AVENUE TO CRANBERRY ROAD</p>																	
	<table border="1"> <thead> <tr> <th>REV</th> <th>DATE</th> <th>REVISIONS</th> <th>NAME</th> </tr> </thead> <tbody> <tr><td> </td><td> </td><td> </td><td> </td></tr> <tr><td> </td><td> </td><td> </td><td> </td></tr> <tr><td> </td><td> </td><td> </td><td> </td></tr> </tbody> </table>	REV	DATE	REVISIONS	NAME													<p>SENIOR DESIGNER: _____ DATE: _____</p>	<p>FILE NUMBER: 32836</p>	<p>PROJECT NUMBER: 16873-0001</p>	<p>REG: 1</p>	<p>DRAWING NUMBER: R1-989-1008</p>
REV	DATE	REVISIONS	NAME																			

PLOT DATE: 2024/03/01 G:\Projects\32000\32836_MoTI_Fulford_Ganges_Road_Widening\02_CADD\DrawingProduction\1000_DesignSections\R1-989-1000.dwg

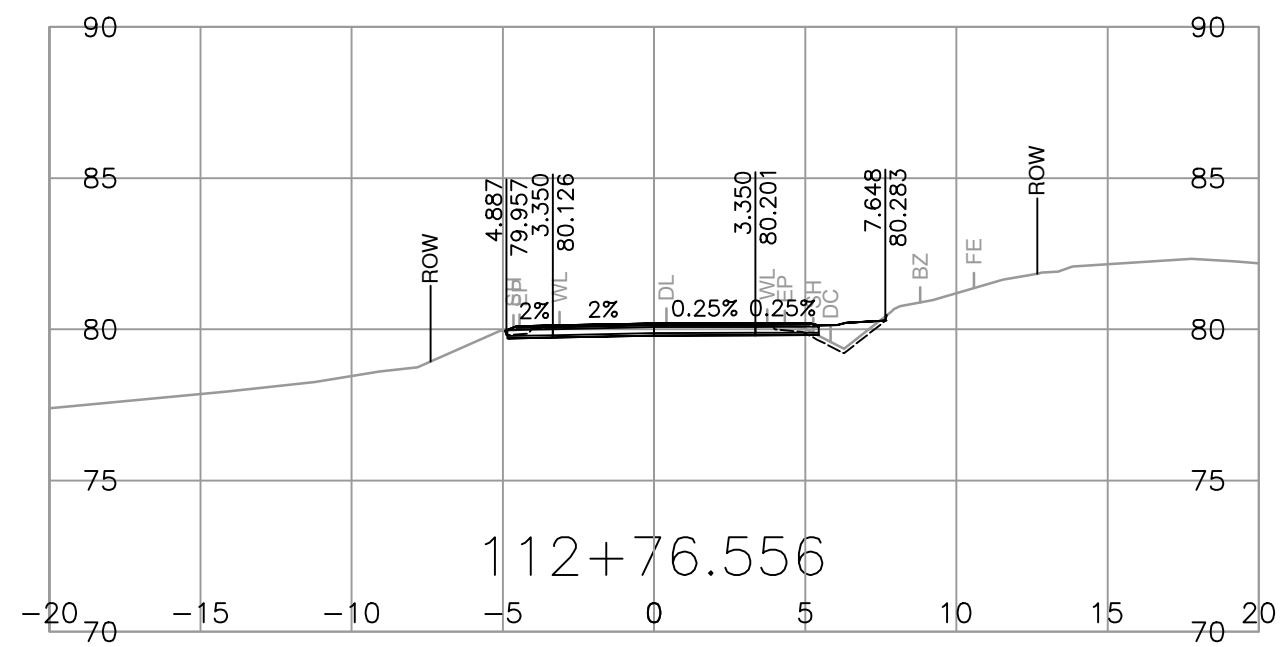
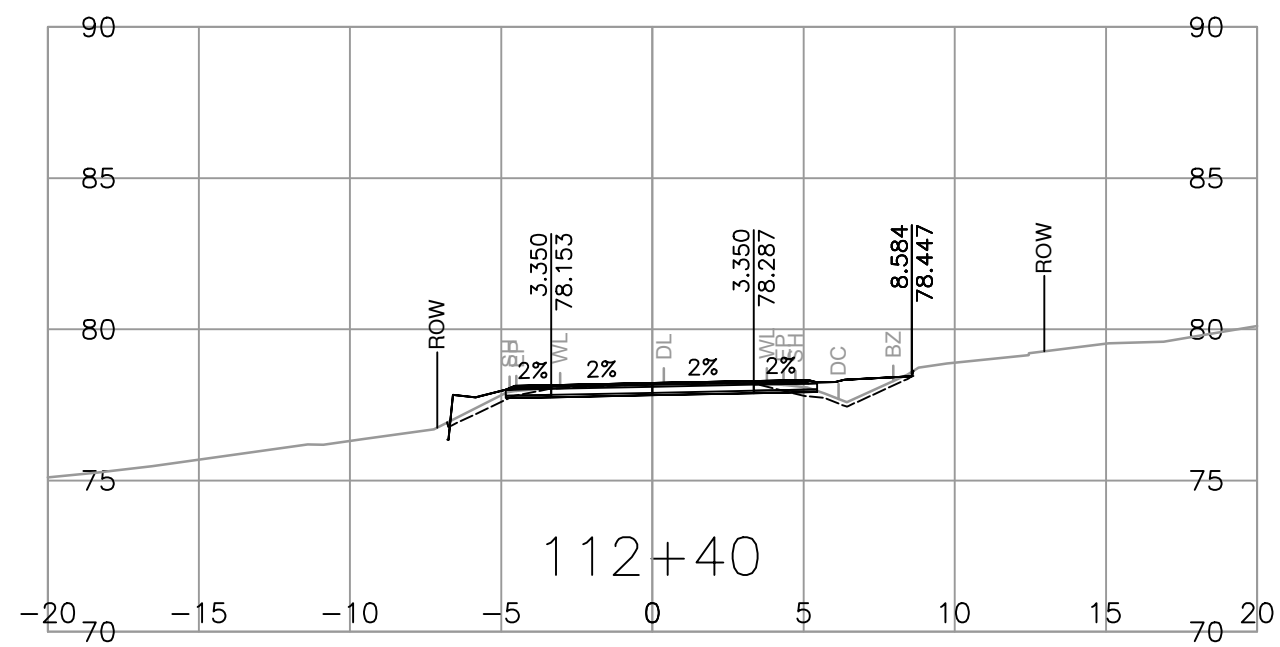
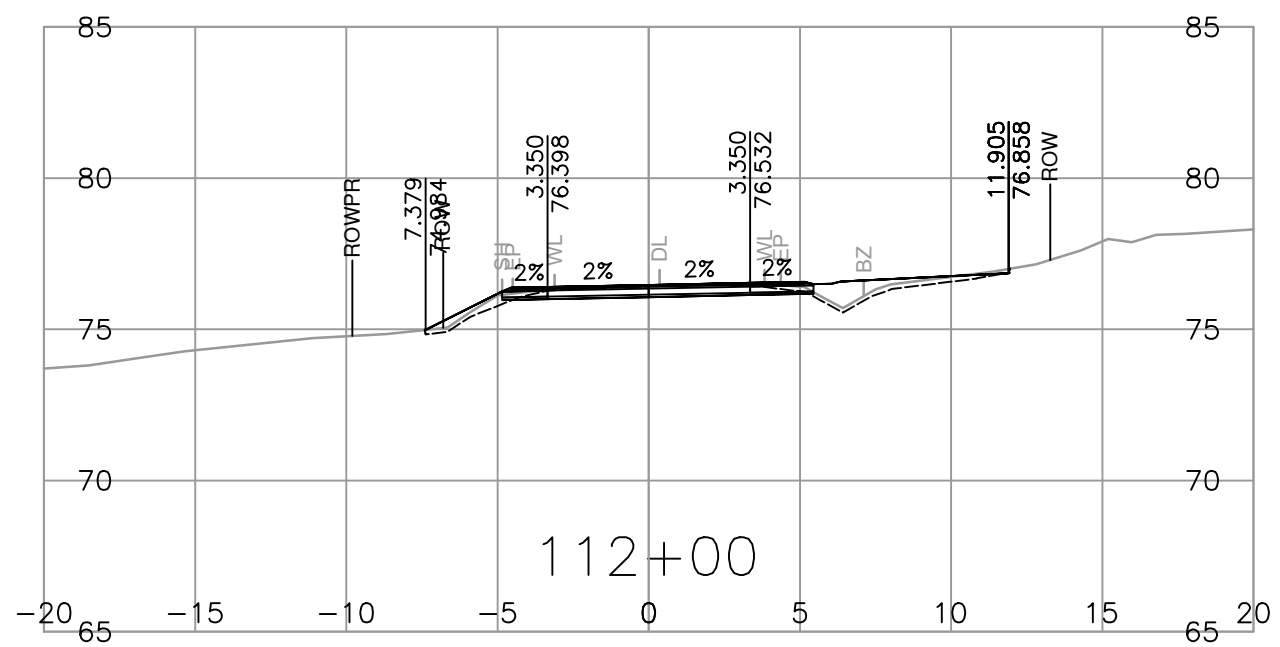
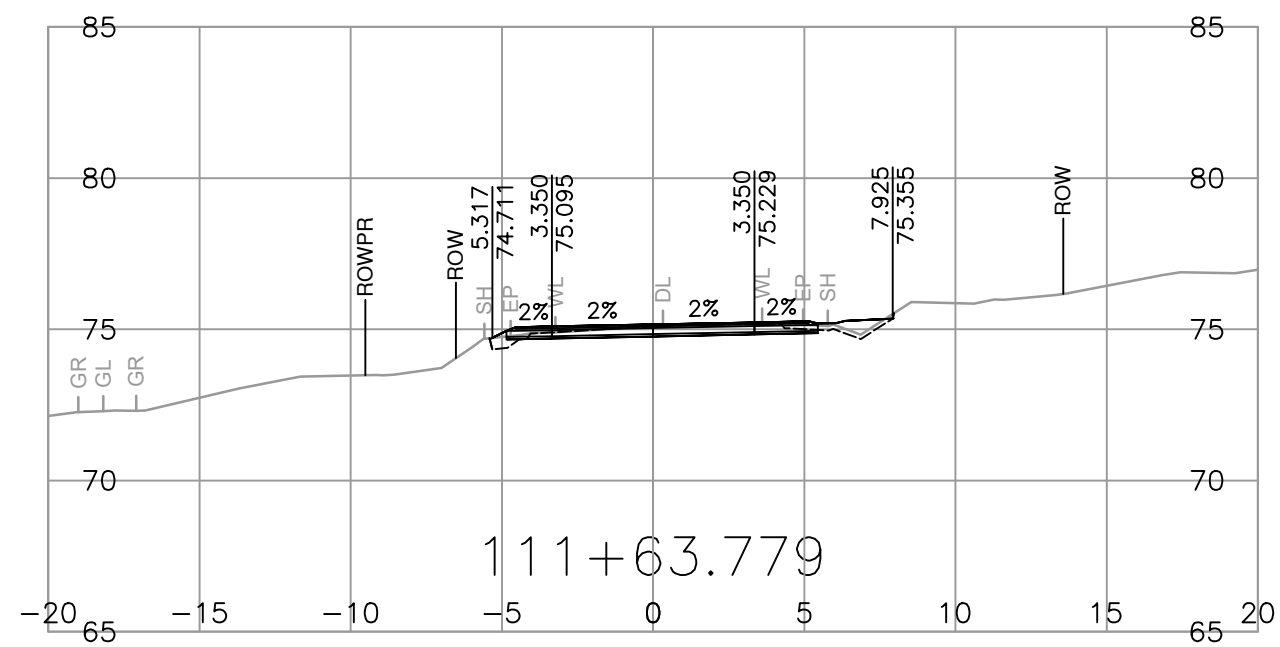
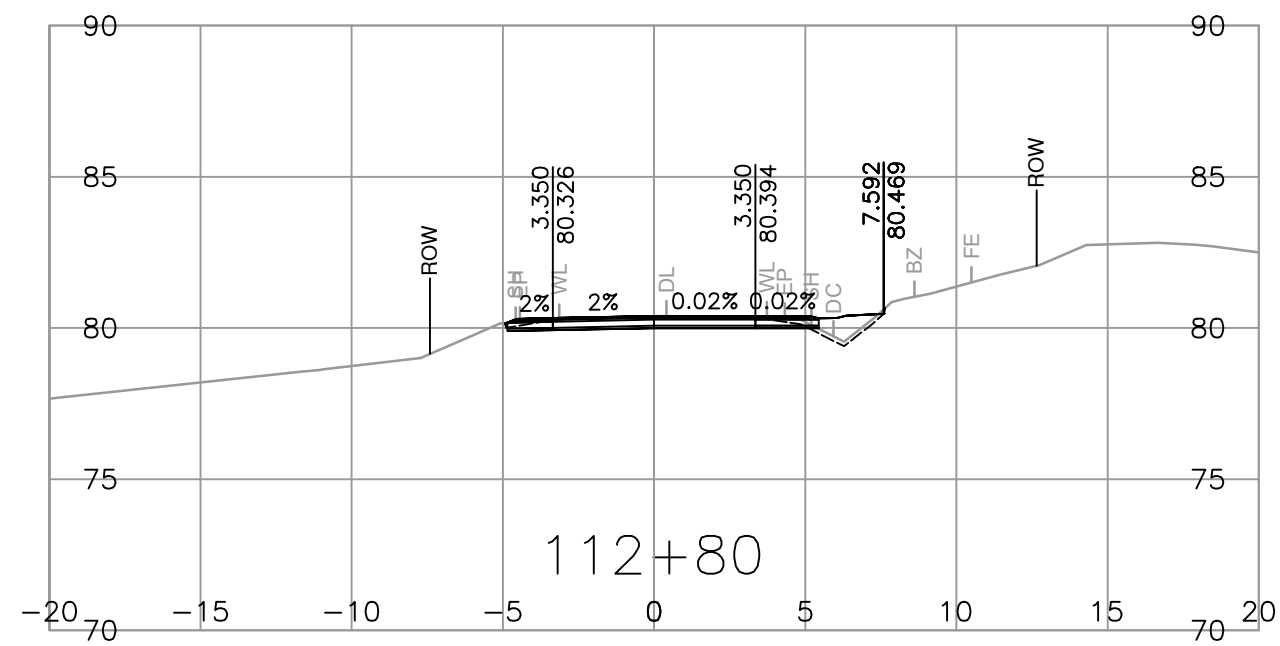
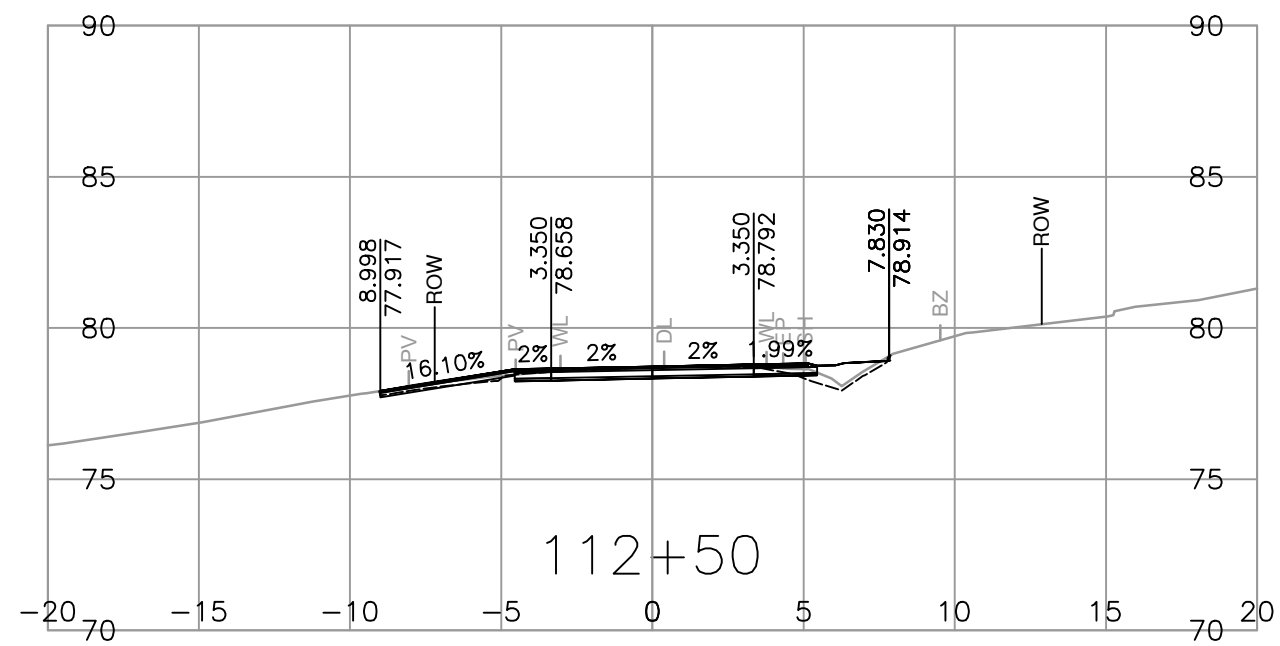
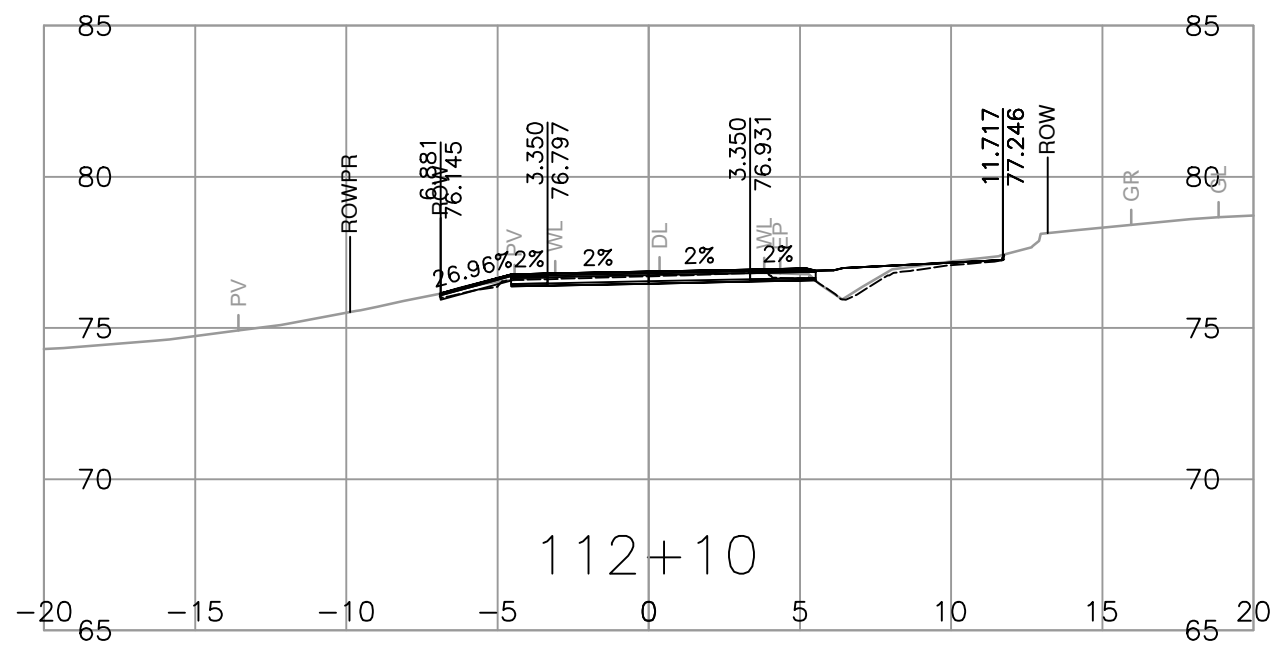
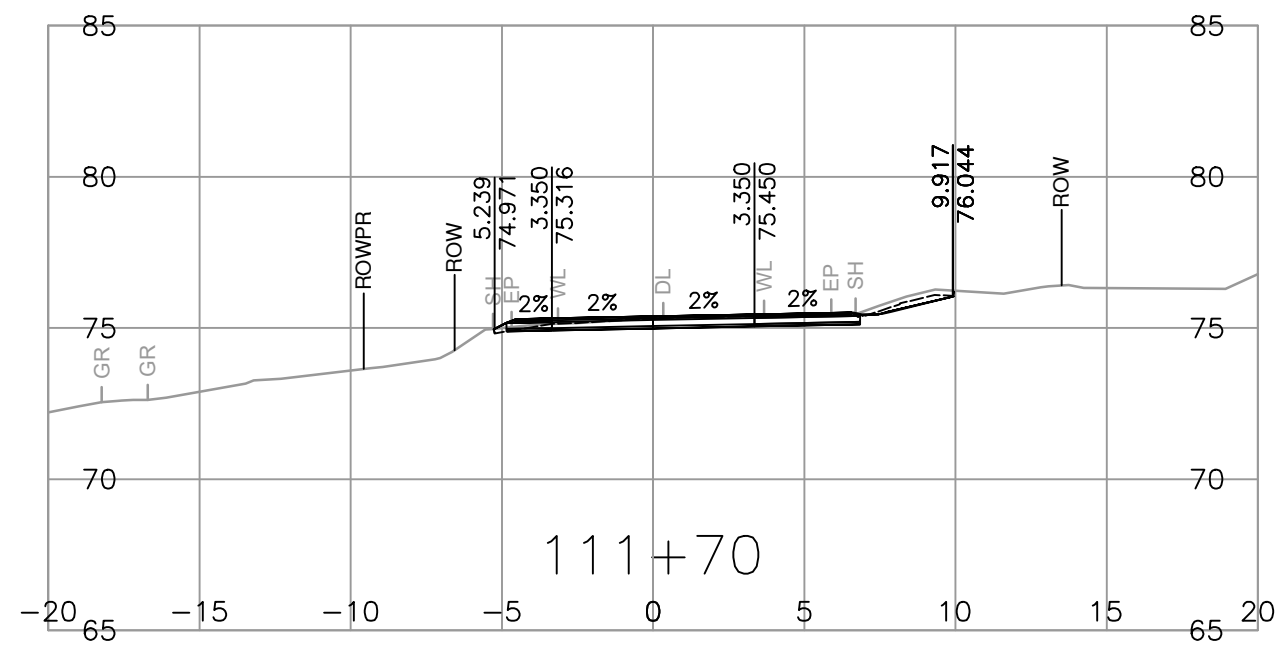
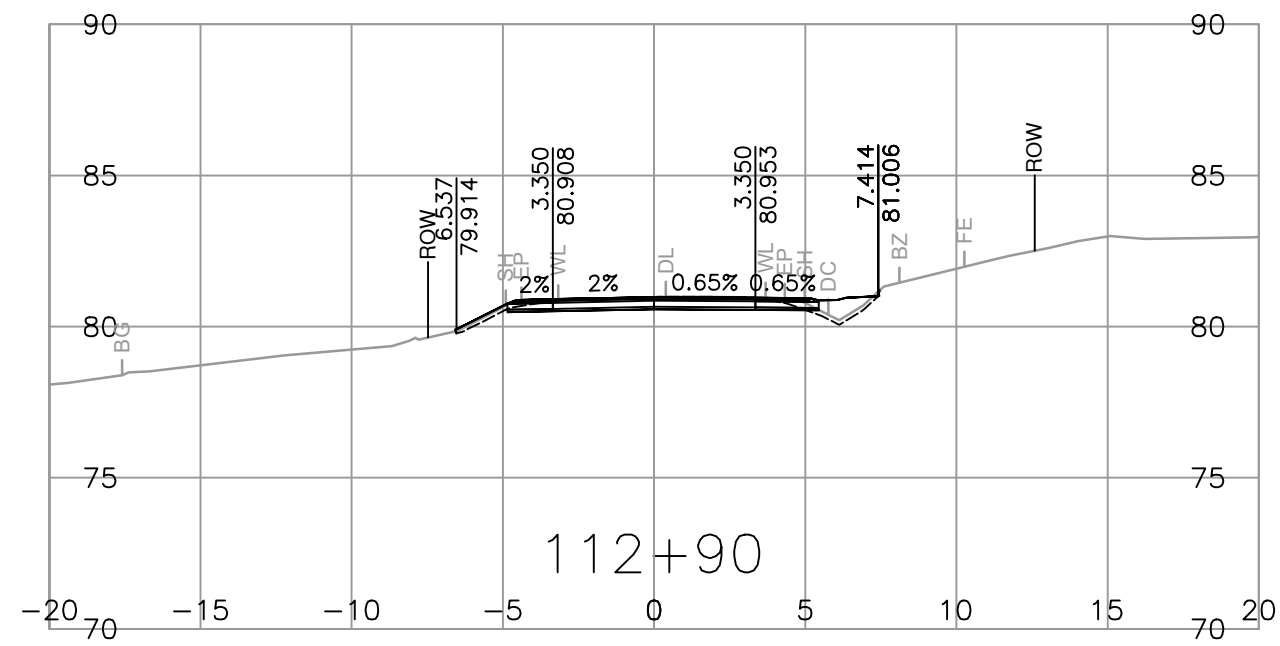
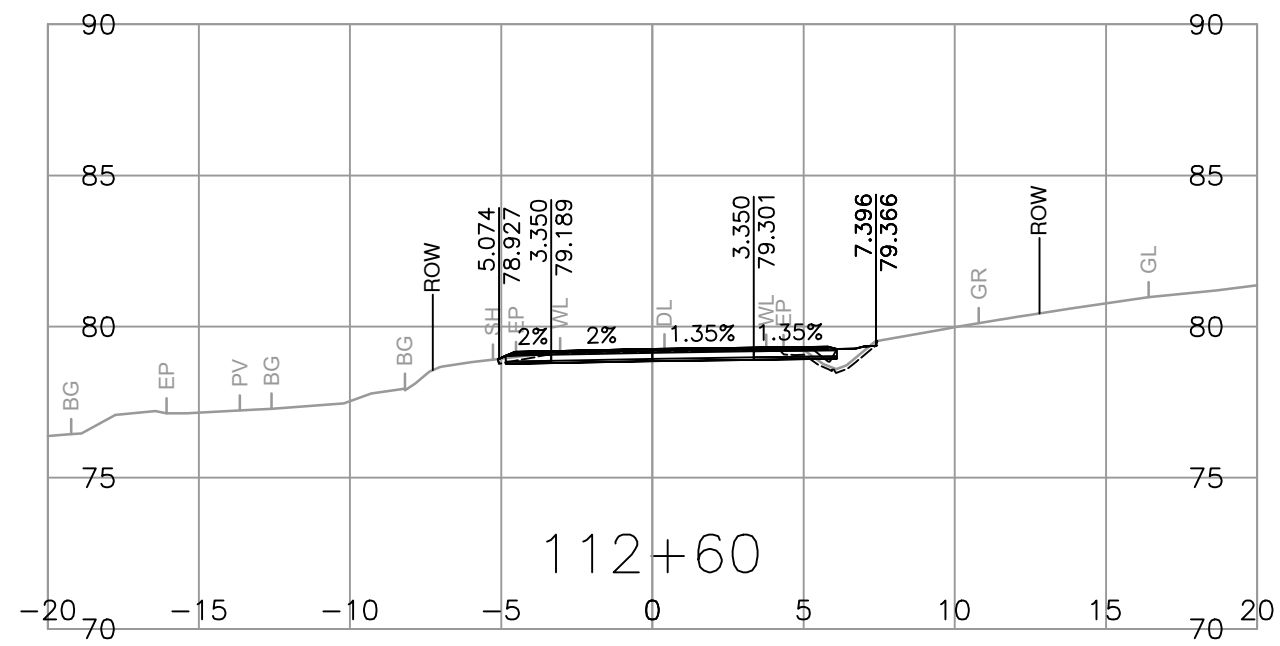
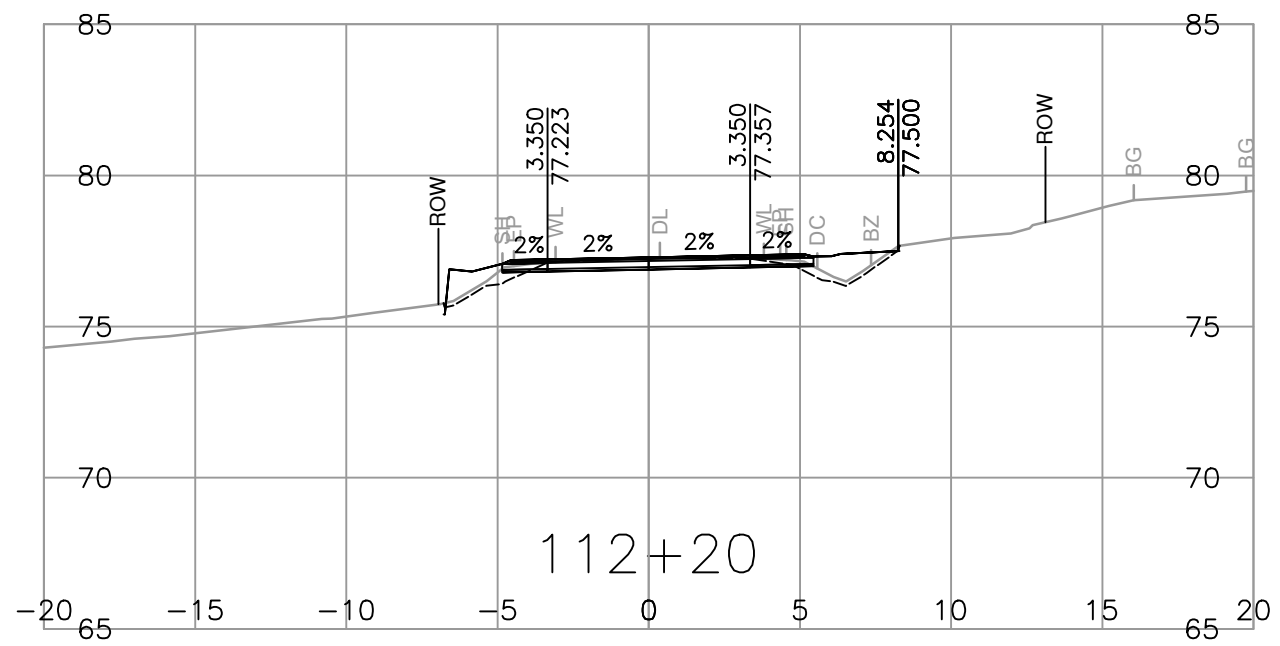
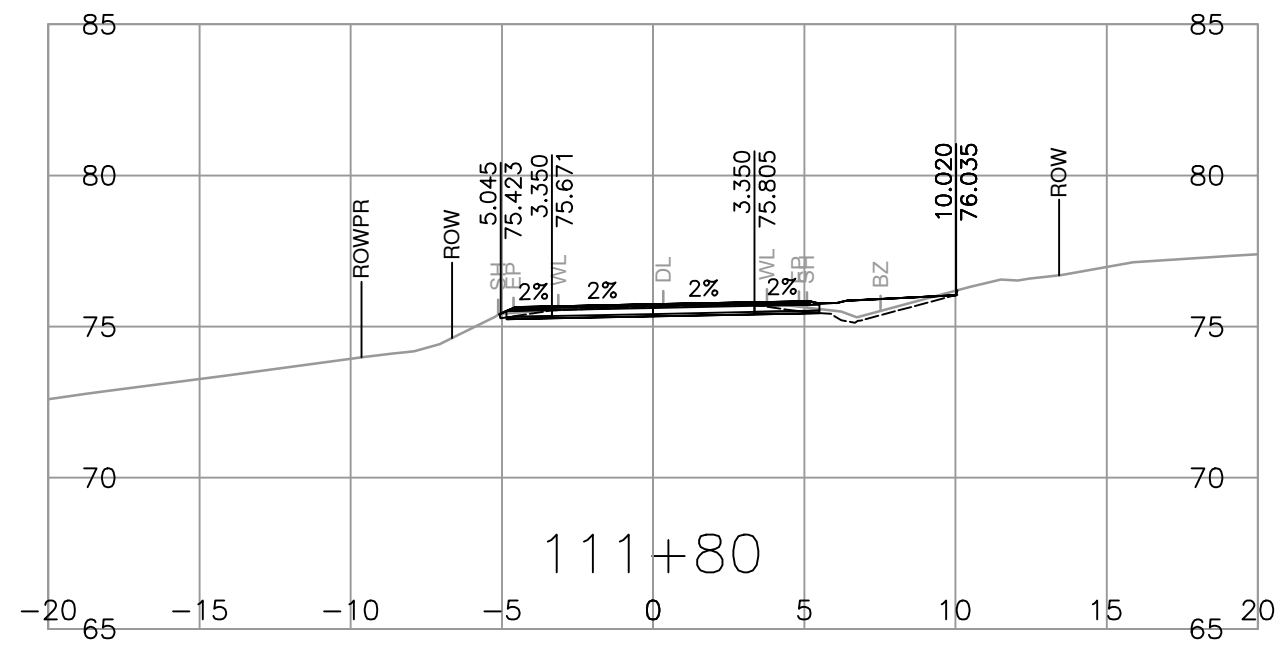
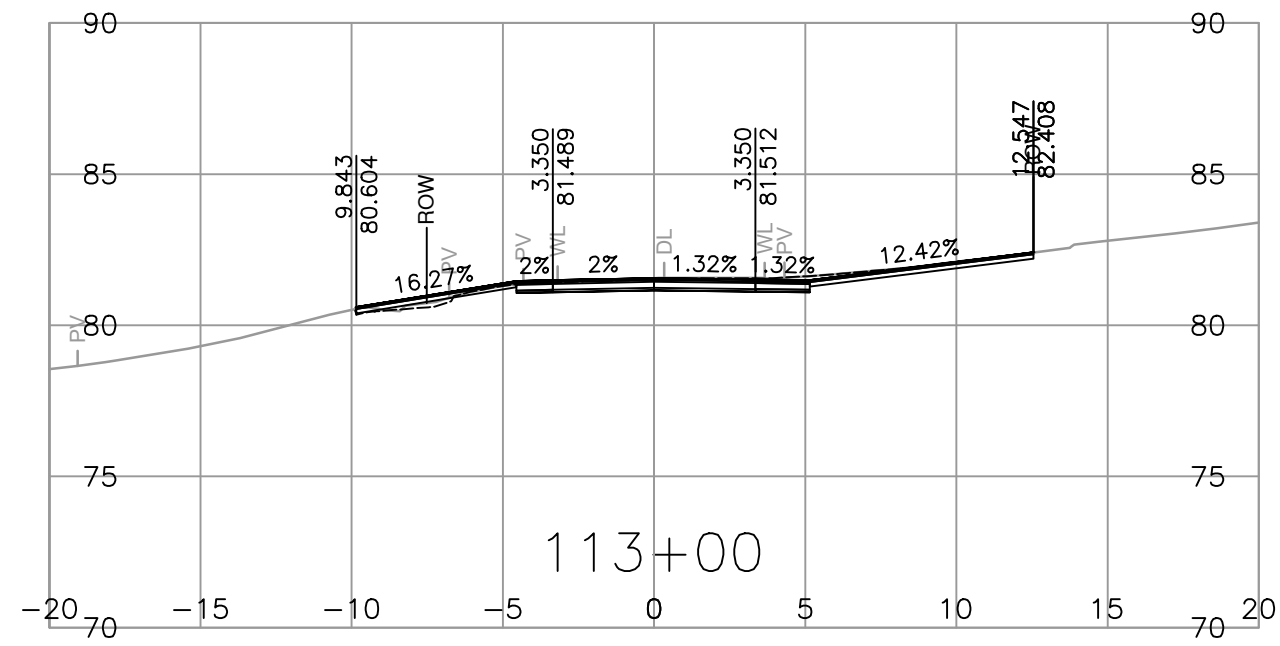
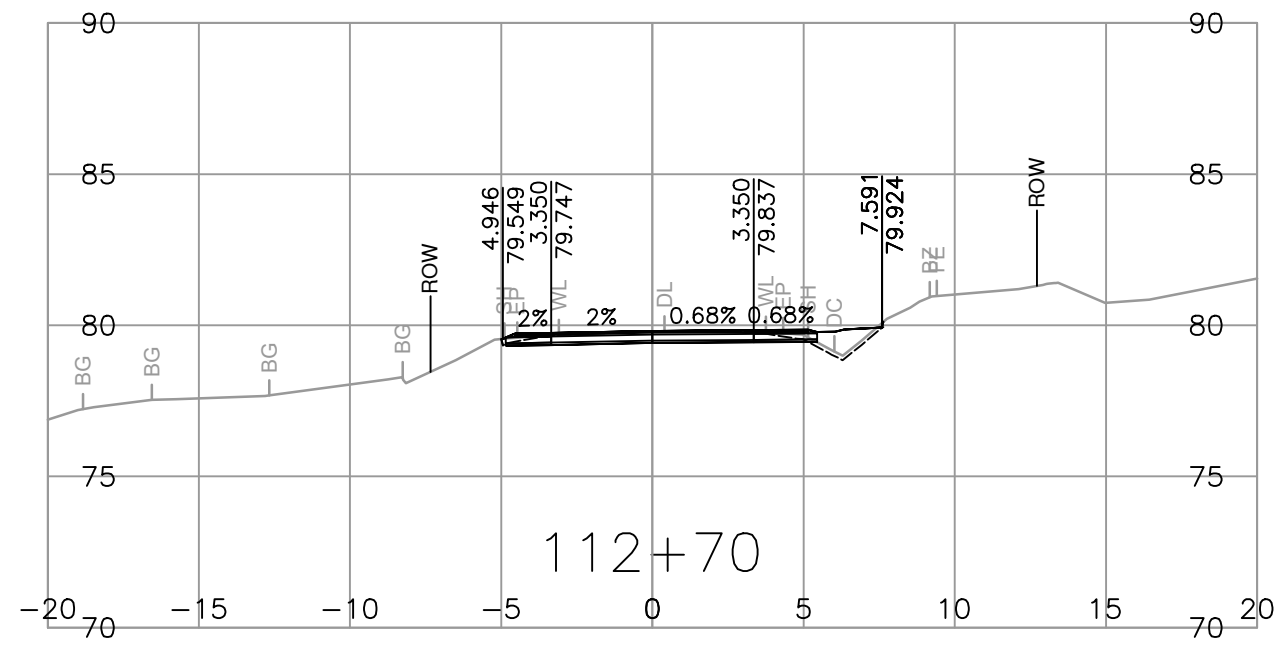
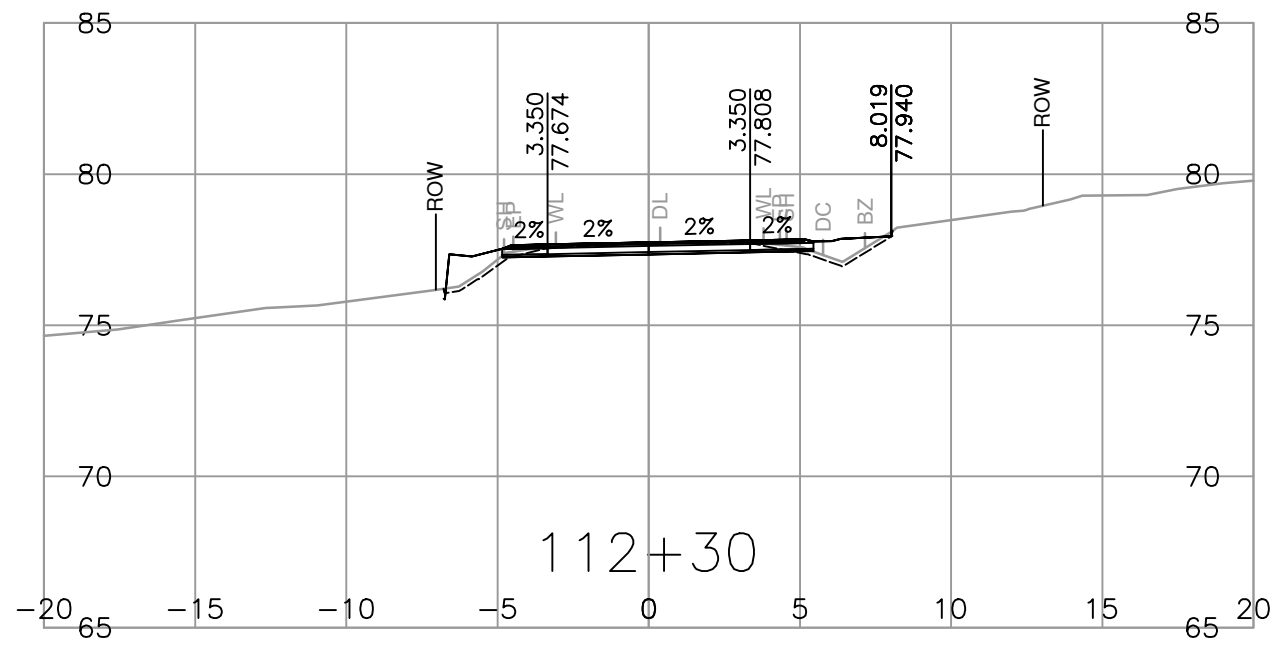
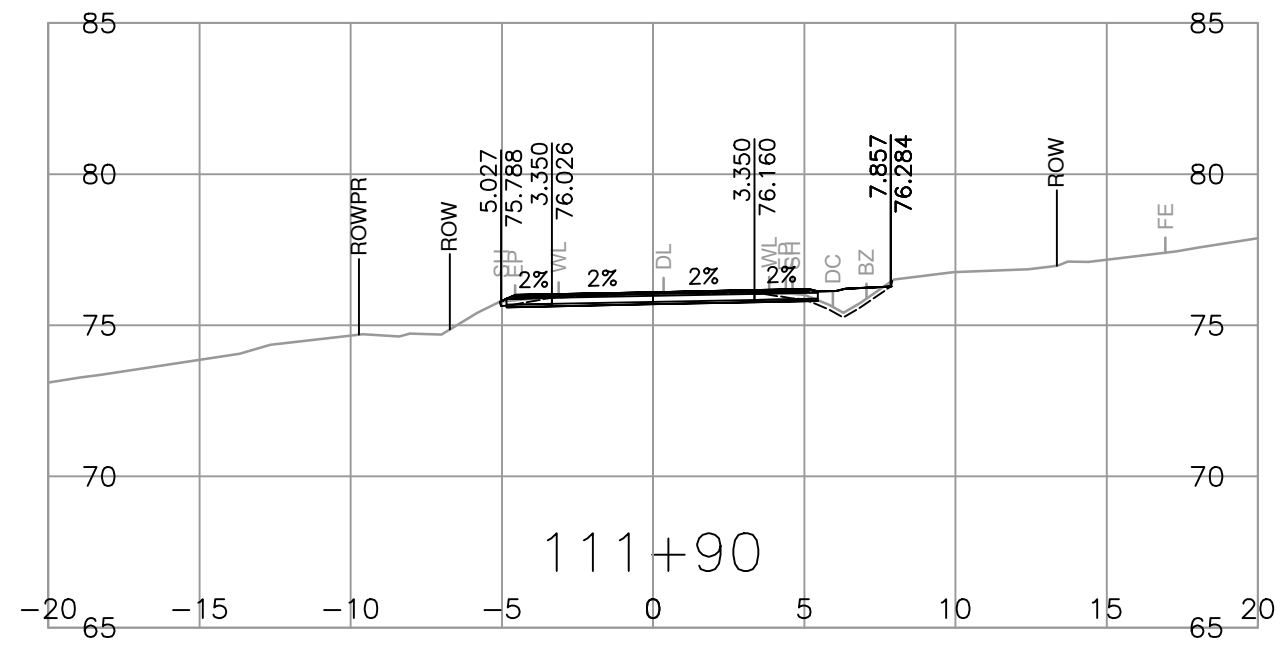

<p>SUITE 201, 8506 - 200 STREET LANGLEY, BRITISH COLUMBIA, V2Y 0M1 PH : 604.371.0091 FAX : 604.371.0098</p>	<p>SCALE 0 2 1:250 12m</p>	<p>CAD FILENAME R1-989-1000 PLOT DATE 2024-03-01</p>	<p>MINISTRY OF TRANSPORTATION AND INFRASTRUCTURE SOUTH COAST REGION VANCOUVER ISLAND DISTRICT</p>	<p>TEMPLATE CROSS SECTIONS FULFORD-GANGES ROAD IMPROVEMENT SEAVIEW AVENUE TO CRANBERRY ROAD</p>																										
	<table border="1"> <thead> <tr> <th>REV</th> <th>DATE</th> <th>REVISIONS</th> <th>NAME</th> </tr> </thead> <tbody> <tr><td> </td><td> </td><td> </td><td> </td></tr> <tr><td> </td><td> </td><td> </td><td> </td></tr> <tr><td> </td><td> </td><td> </td><td> </td></tr> </tbody> </table>	REV	DATE	REVISIONS	NAME													<p>DESIGNED B. PEEBLES DATE 2024-02-01 QUALITY CONTROL Z. PENDON DATE 2024-02-01 QUALITY ASSURANCE A. SANTOS DATE 2024-02-01 DRAWN J. SHIM DATE 2024-02-01</p>	<p>SENIOR DESIGNER _____ DATE _____</p>	<p>L100</p>	<table border="1"> <tr> <th>FILE NUMBER</th> <th>PROJECT NUMBER</th> <th>REG</th> <th>DRAWING NUMBER</th> <th>REV</th> </tr> <tr> <td>32836</td> <td>16873-0001</td> <td>1</td> <td>R1-989-1009</td> <td> </td> </tr> </table>	FILE NUMBER	PROJECT NUMBER	REG	DRAWING NUMBER	REV	32836	16873-0001	1	R1-989-1009
REV	DATE	REVISIONS	NAME																											
FILE NUMBER	PROJECT NUMBER	REG	DRAWING NUMBER	REV																										
32836	16873-0001	1	R1-989-1009																											

PLOT DATE: 2024/03/22 G:\Projects\32000\32836_MoTI_Fulford_Ganges_Road_Widening\02_CADD\DrawingProduction\1000_DesignSections\R1-989-1000.dwg

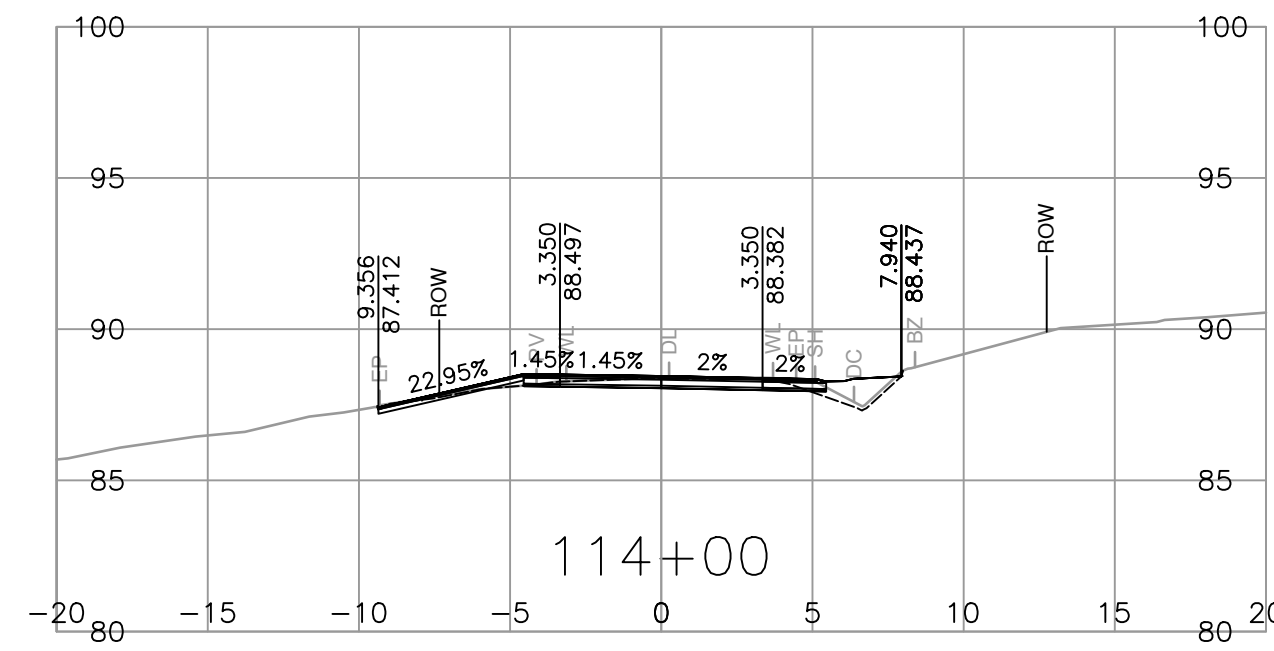
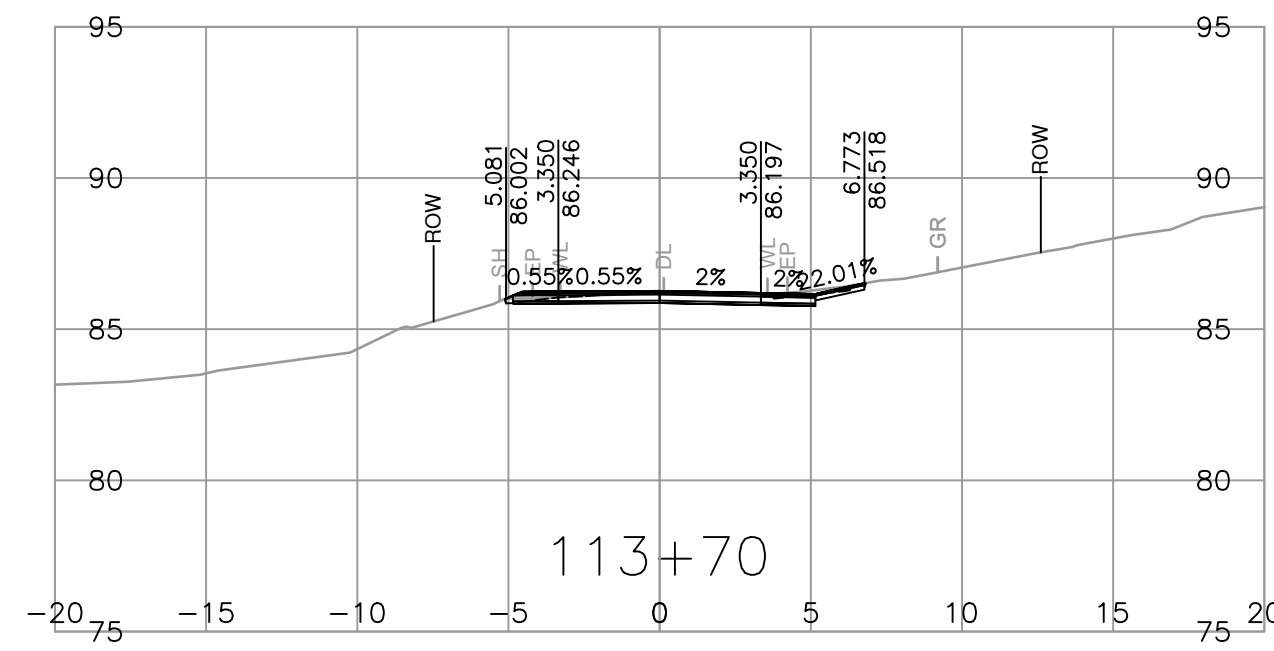
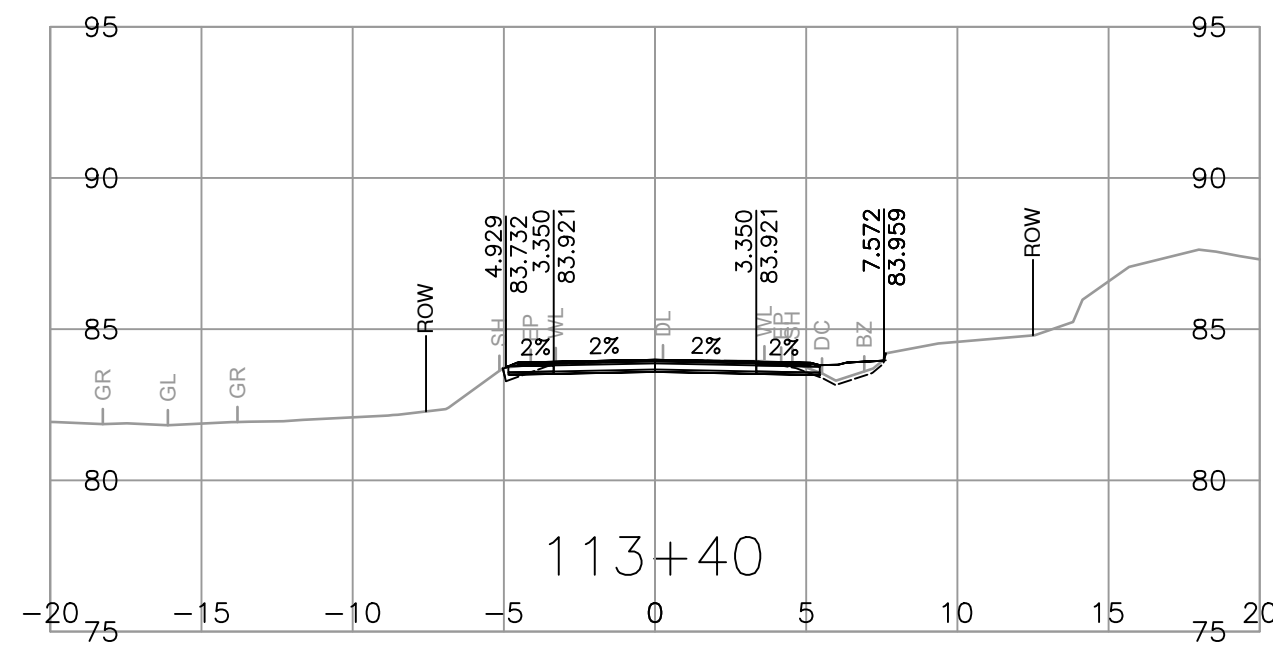
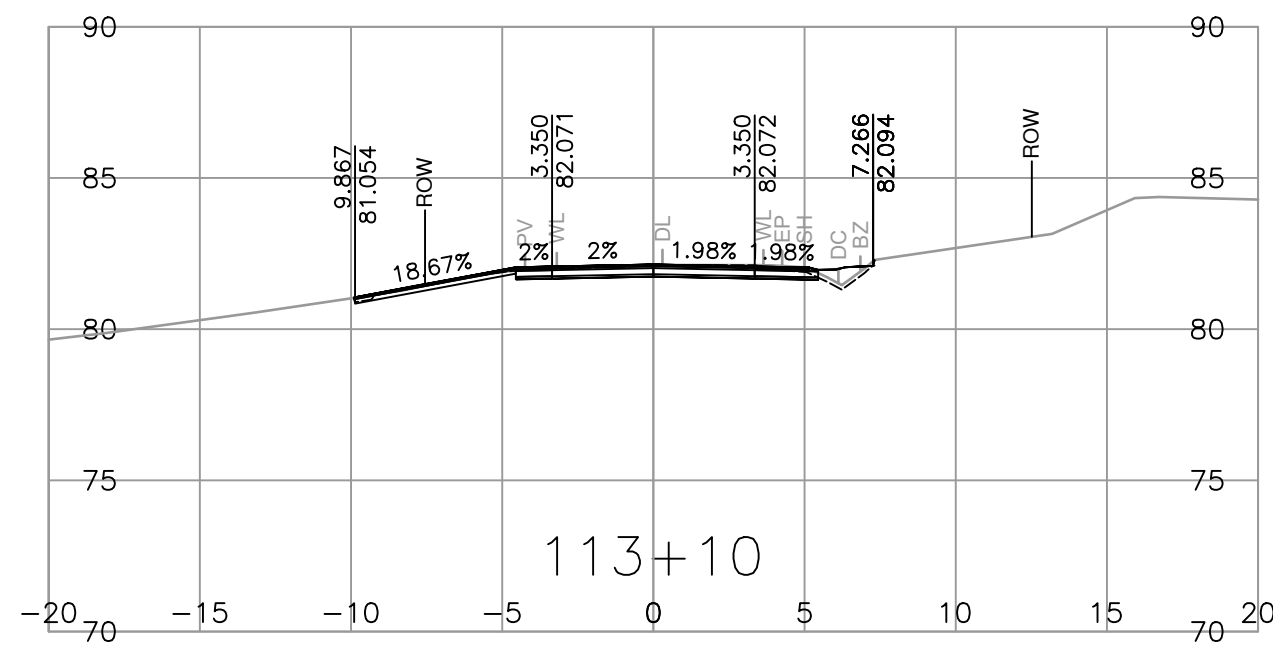
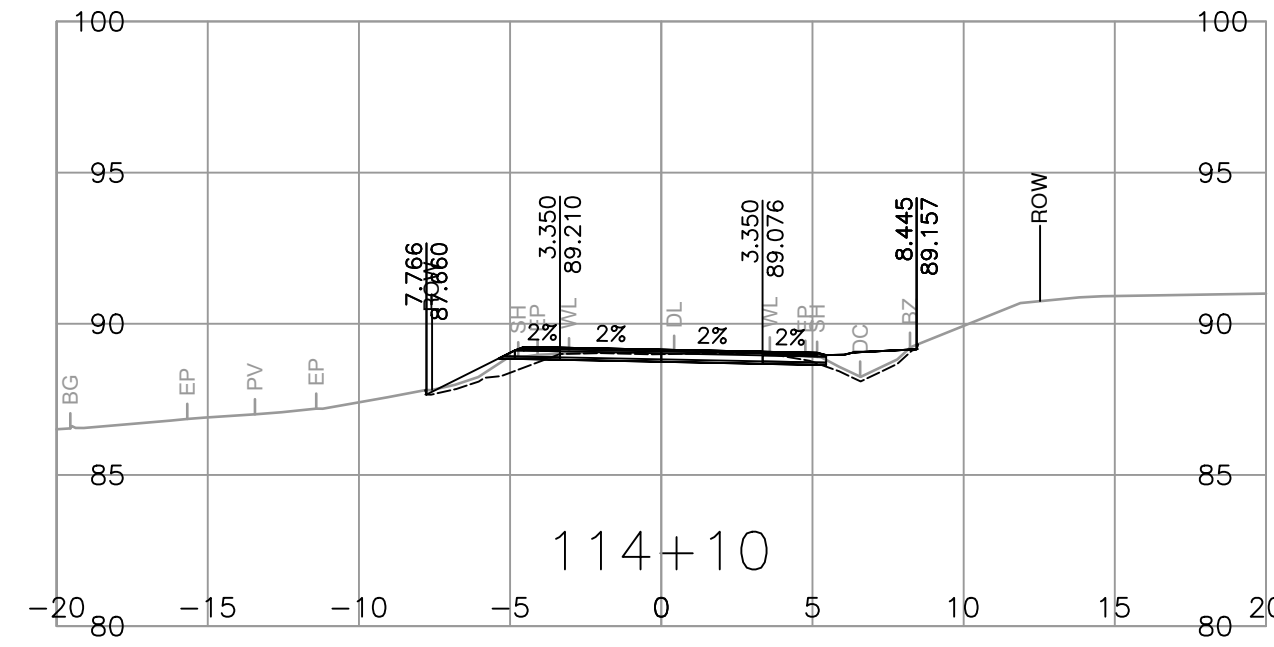
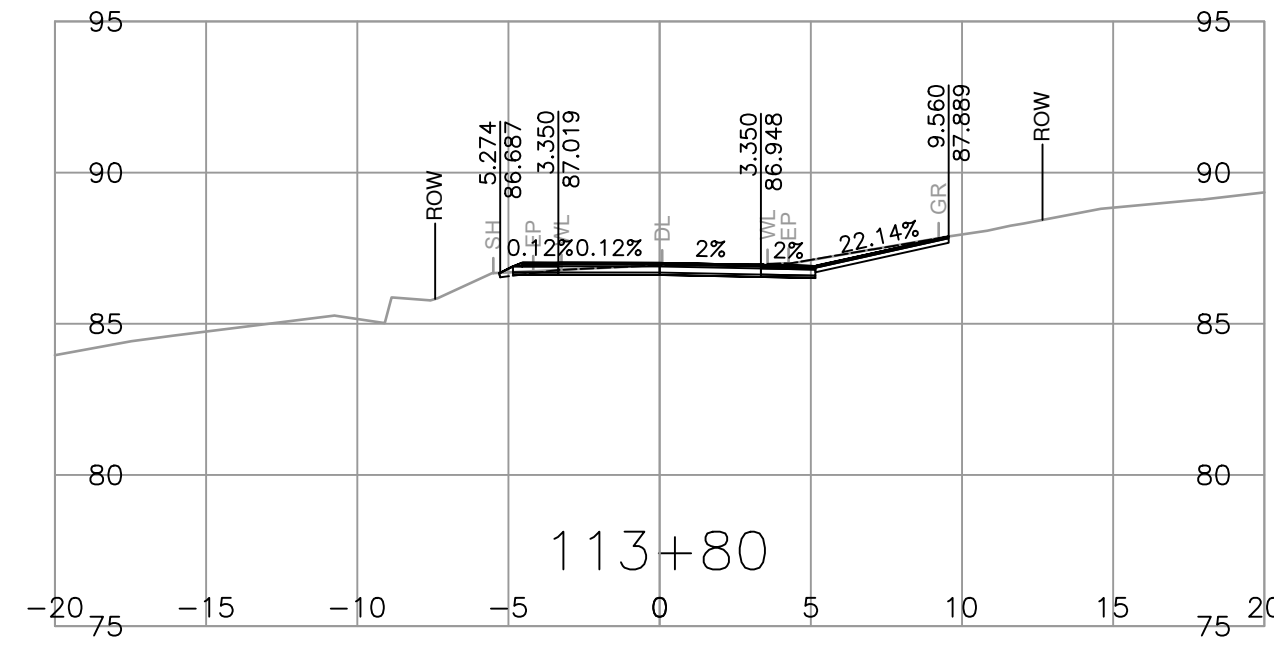
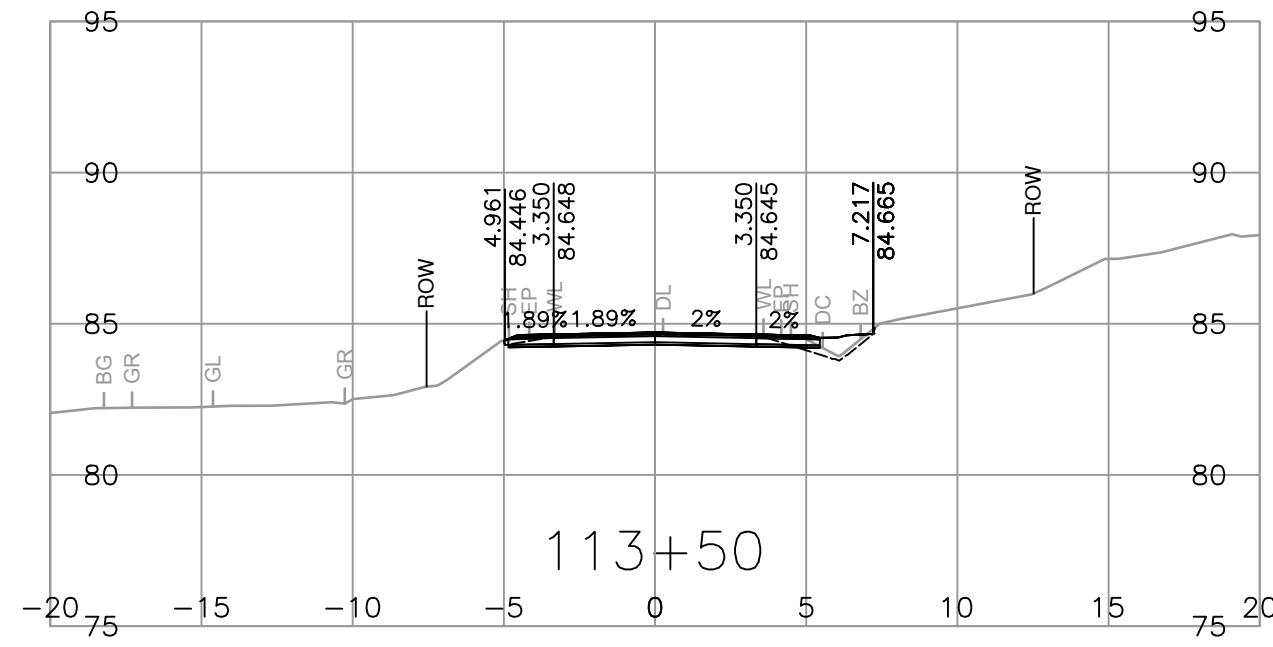
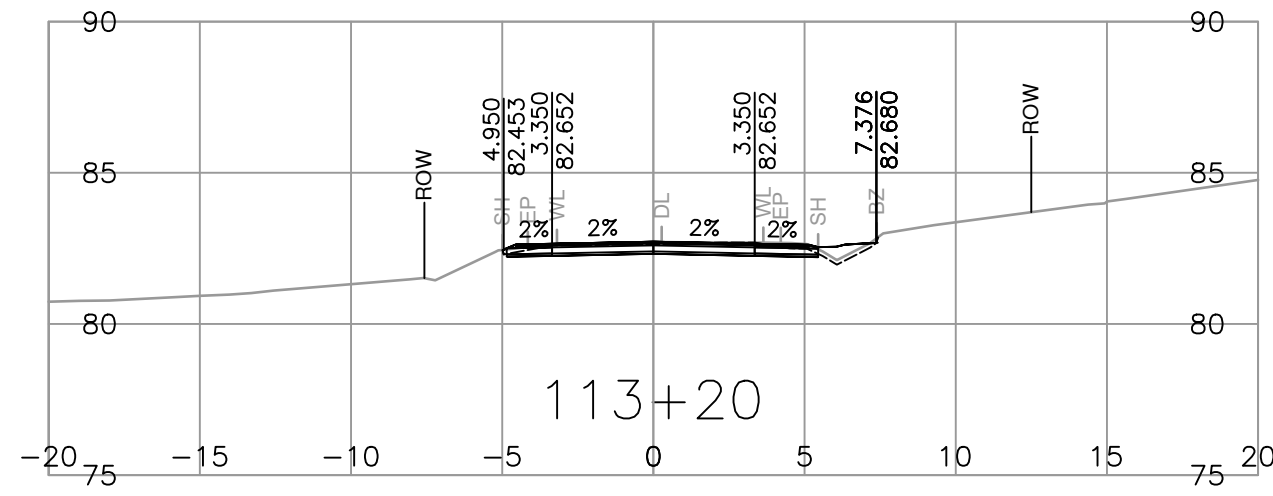
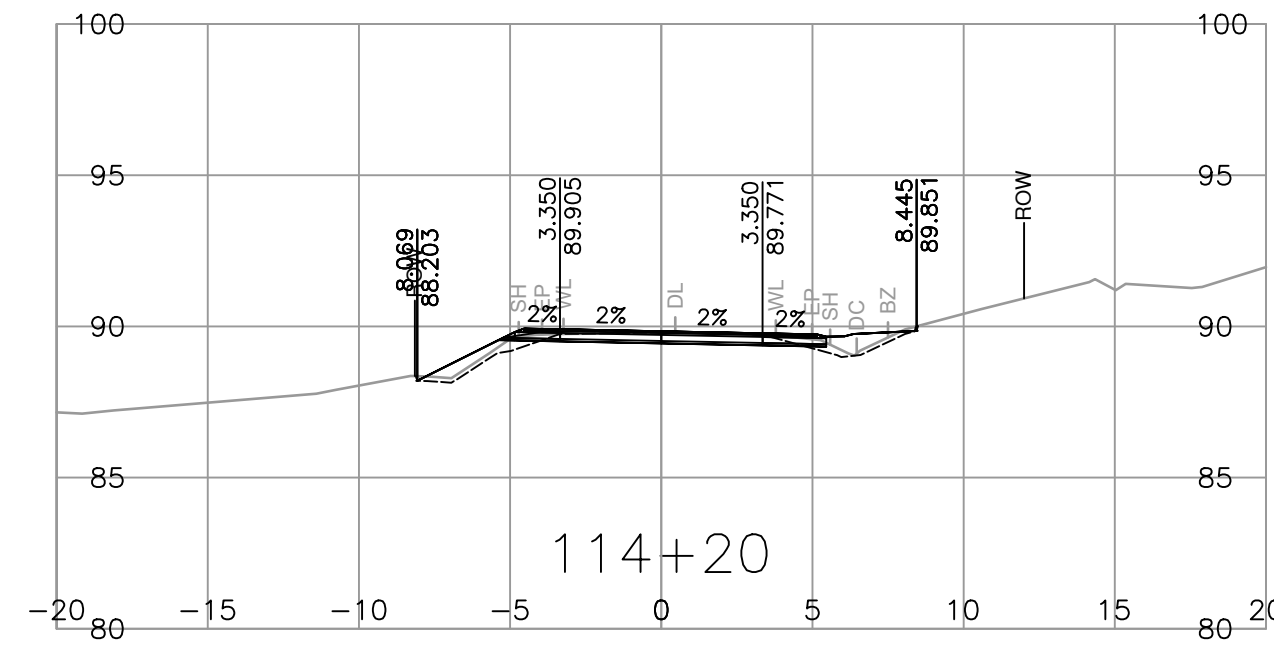
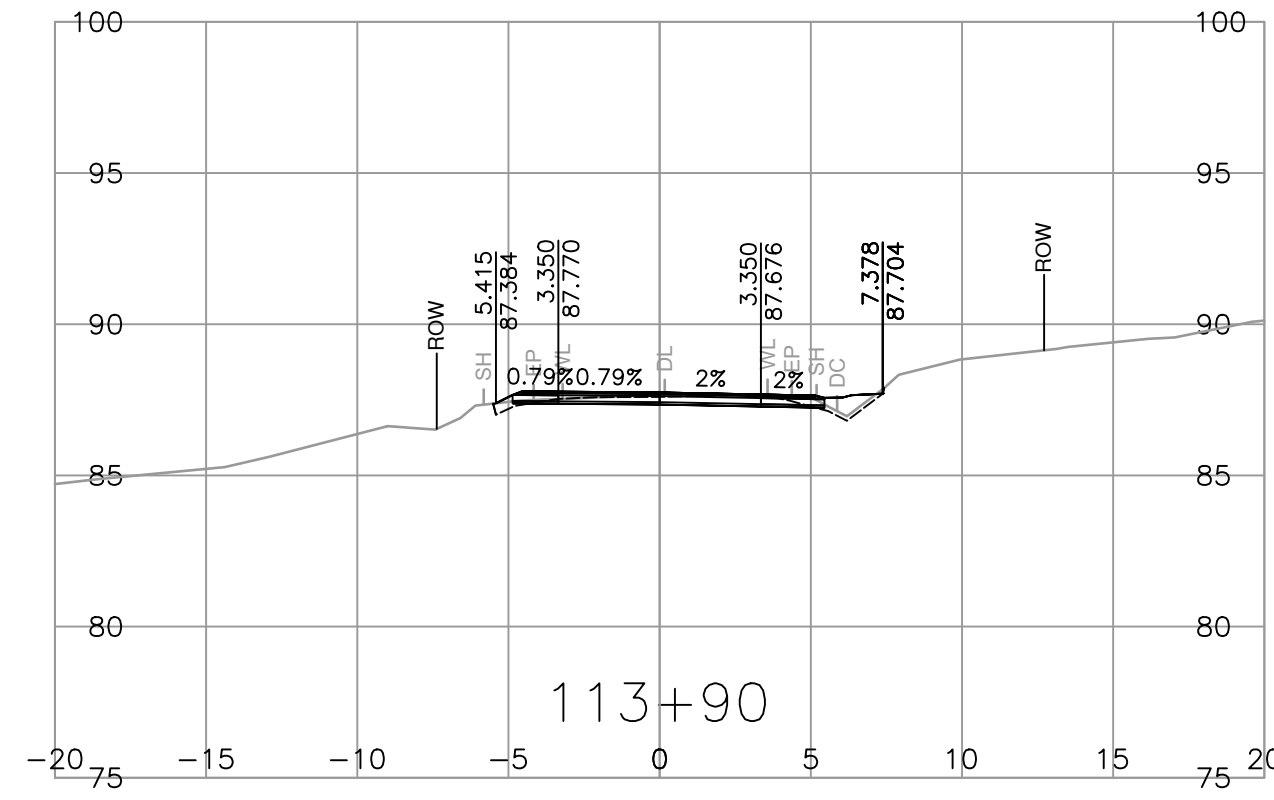
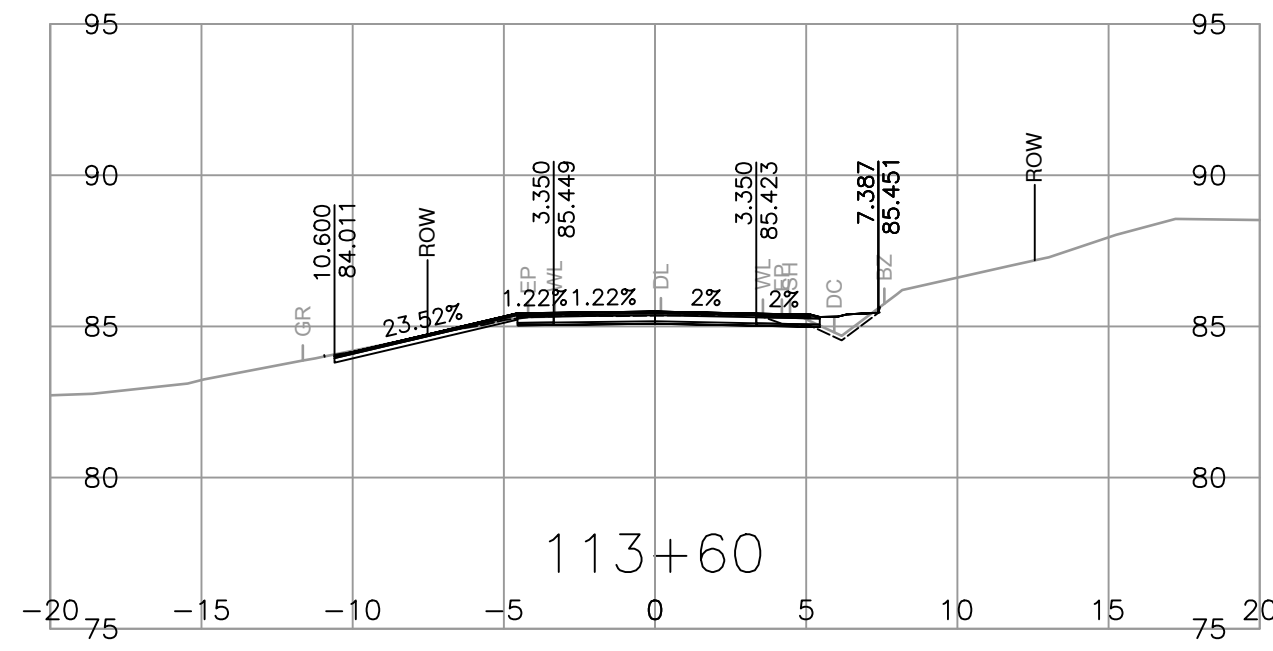
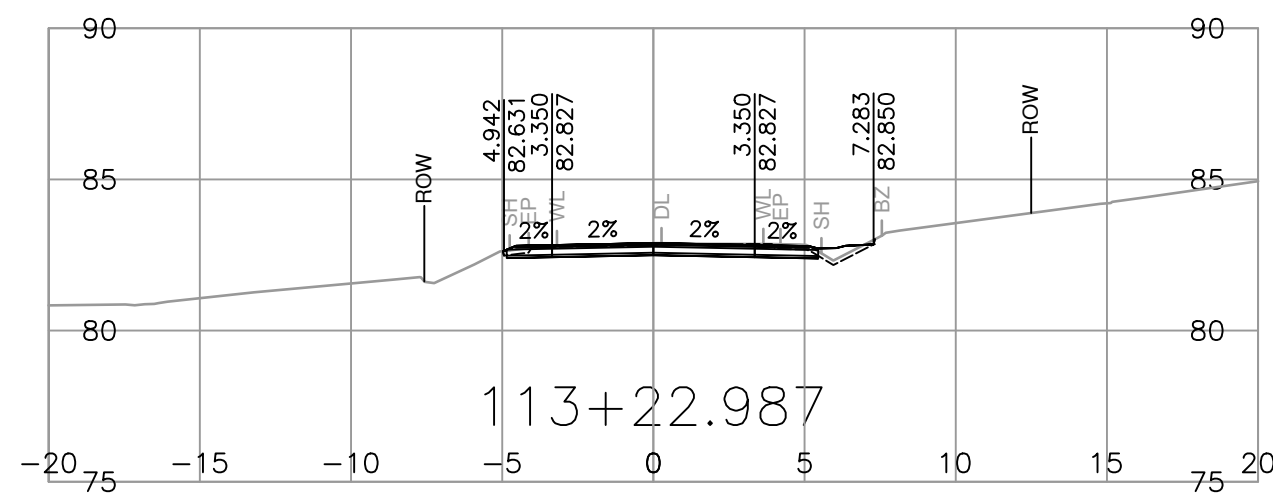
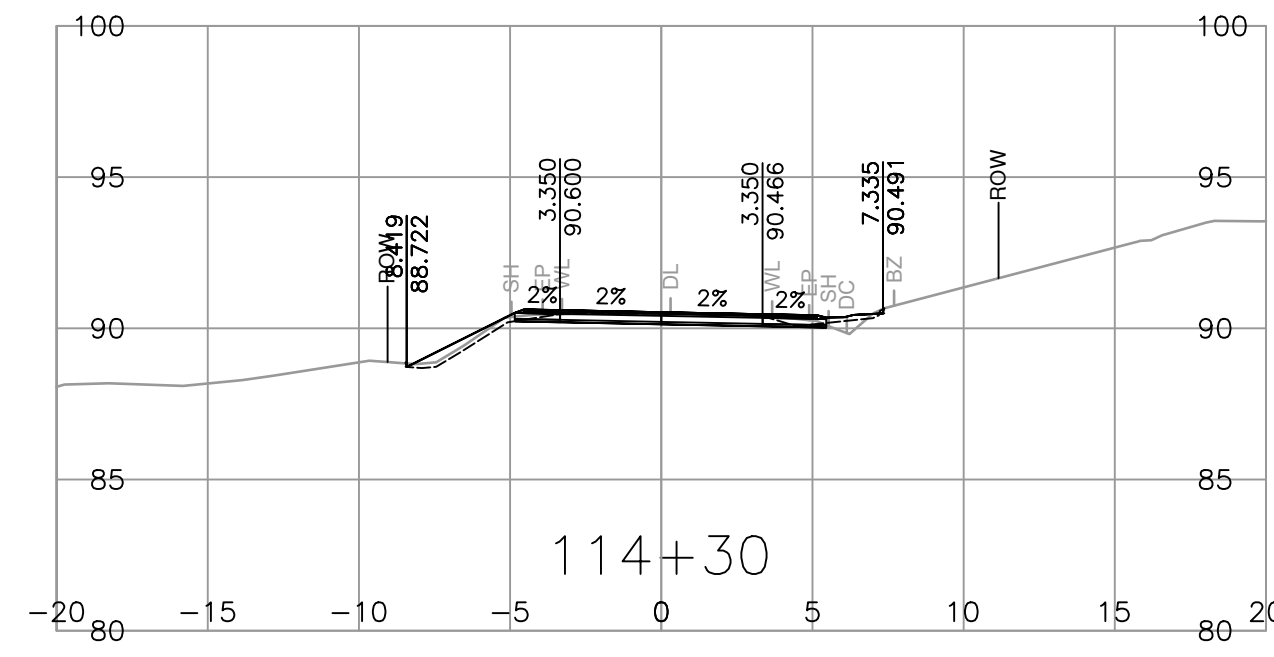
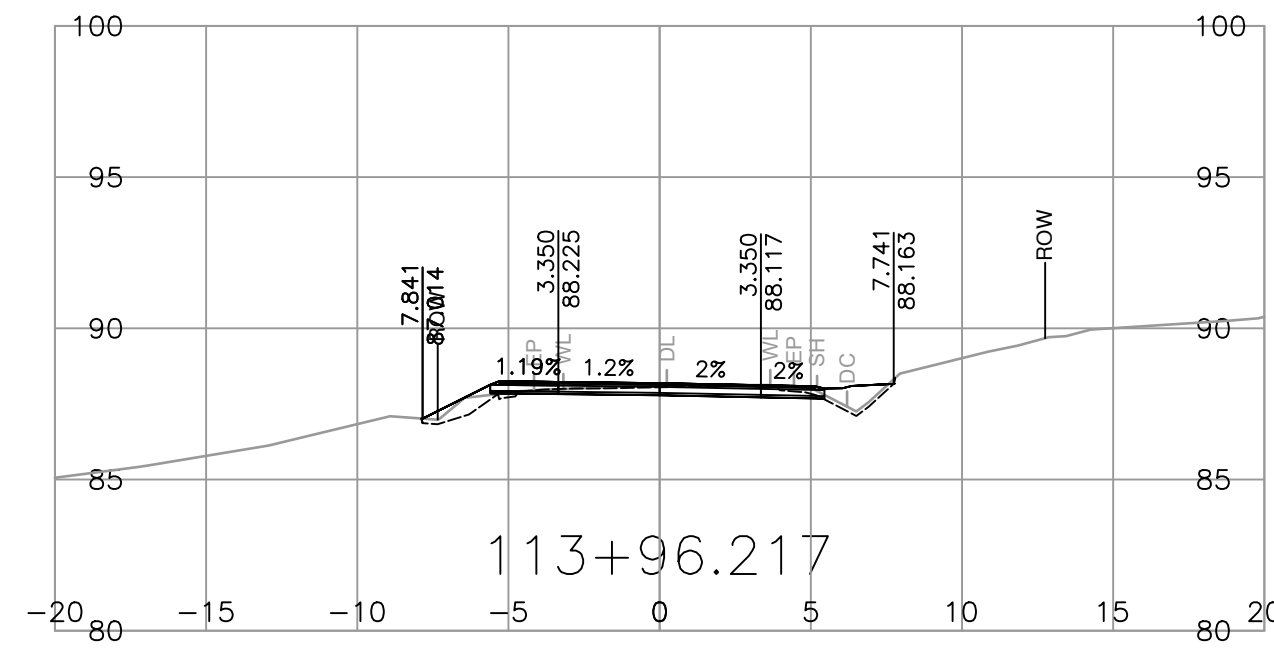
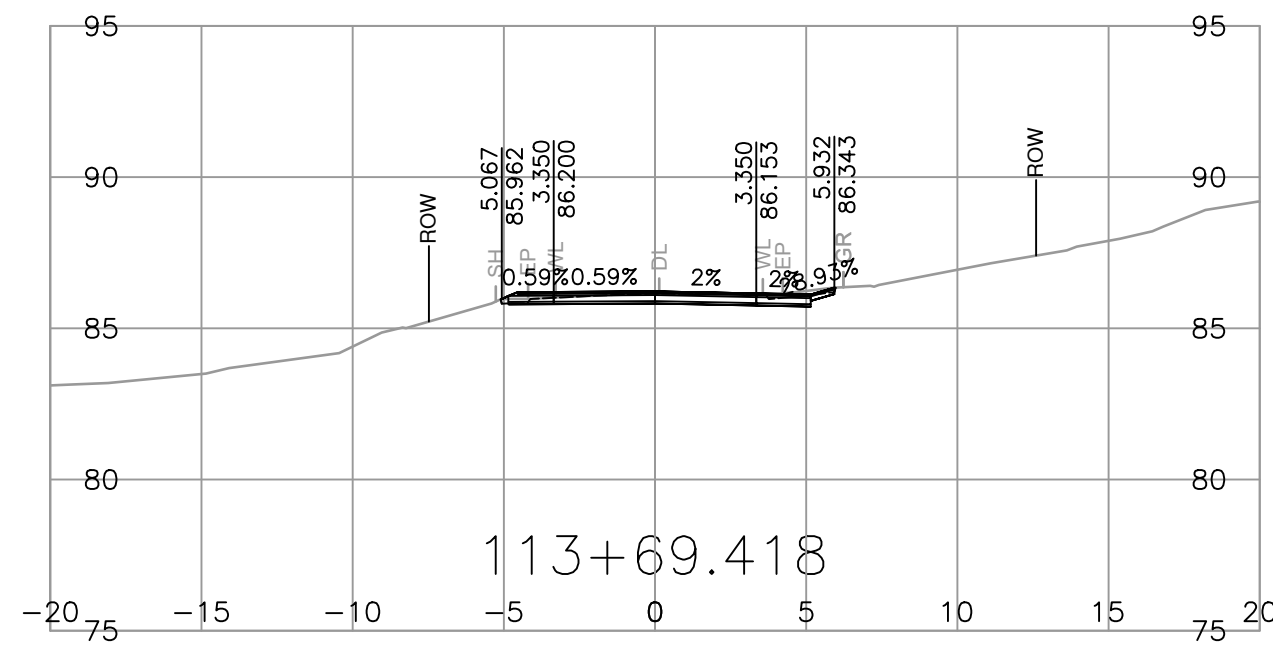
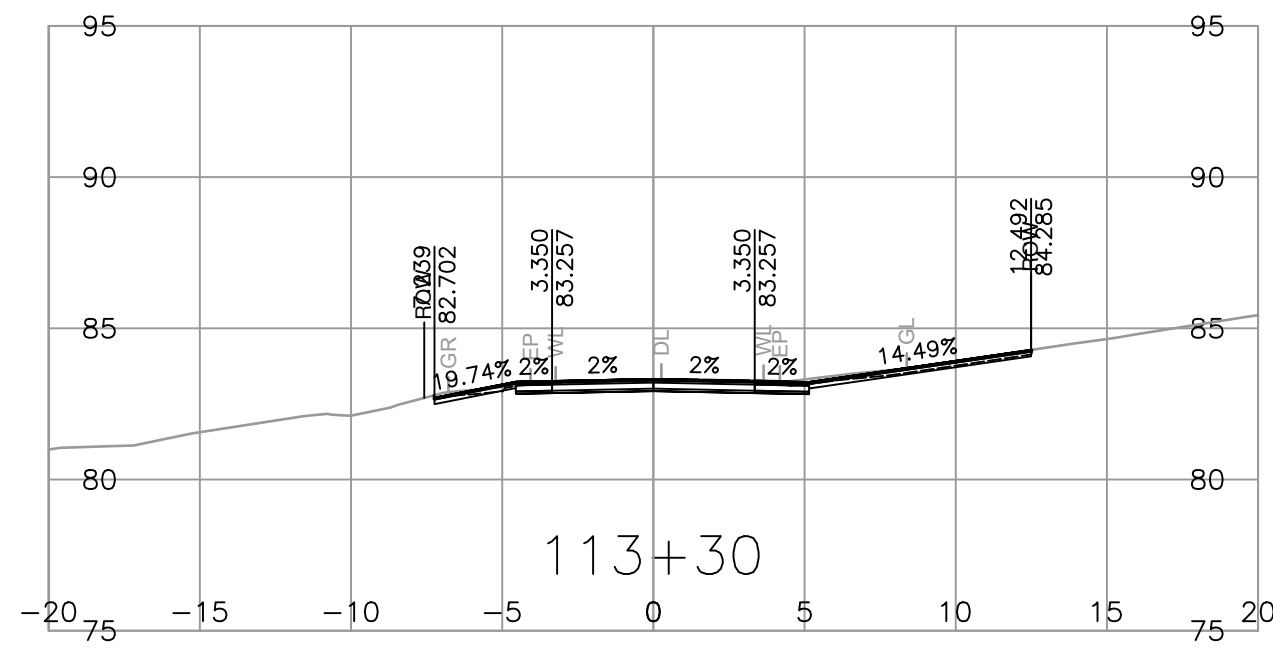

<p>SUITE 201, 8506 - 200 STREET LANGLEY, BRITISH COLUMBIA, V2Y 0M1 PH : 604.371.0091 FAX : 604.371.0098</p>	<p>SCALE 0 2 1:250 12m</p>	<p>CAD FILENAME R1-989-1000 PLOT DATE 2024-03-22</p>	<p>MINISTRY OF TRANSPORTATION AND INFRASTRUCTURE SOUTH COAST REGION VANCOUVER ISLAND DISTRICT</p>	<p>DESIGNED B. PEEBLES DATE 2024-02-01 QUALITY CONTROL Z. PENDON DATE 2024-02-01 QUALITY ASSURANCE A. SANTOS DATE 2024-02-01 DRAWN J. SHIM DATE 2024-02-01</p>	<p>FILE NUMBER 32836 PROJECT NUMBER 16873-0001 REG 1 DRAWING NUMBER R1-989-1010 REV</p>														
	<table border="1"> <thead> <tr> <th>REV</th> <th>DATE</th> <th>REVISIONS</th> <th>NAME</th> </tr> </thead> <tbody> <tr><td> </td><td> </td><td> </td><td> </td></tr> <tr><td> </td><td> </td><td> </td><td> </td></tr> <tr><td> </td><td> </td><td> </td><td> </td></tr> </tbody> </table>	REV	DATE	REVISIONS	NAME													<p>SENIOR DESIGNER _____ DATE _____</p>	<p>L100</p>
REV	DATE	REVISIONS	NAME																

PLOT DATE: 2024/03/01 G:\Projects\32000\32836_MoTI_Fulford_Ganges_Road_Widening\02_CADD\DrawingProduction\1000_DesignSections\R1-989-1000.dwg

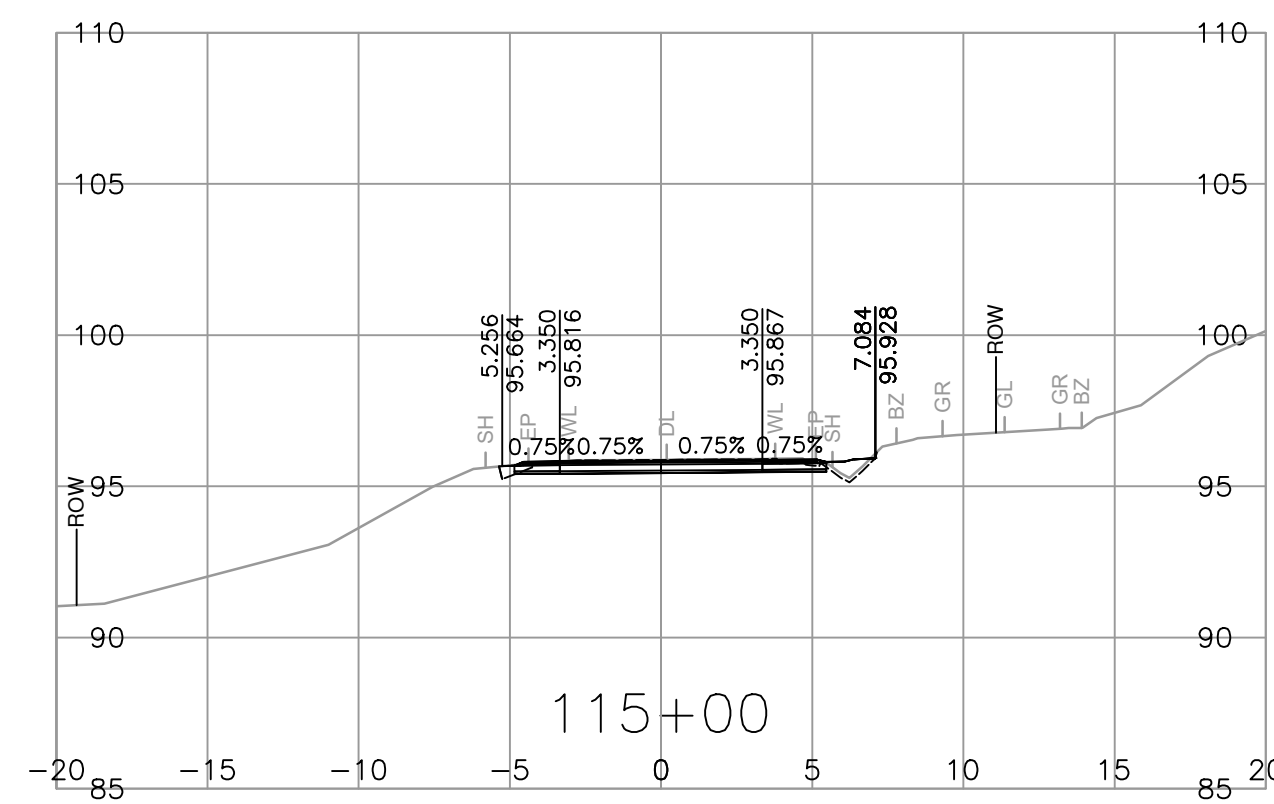
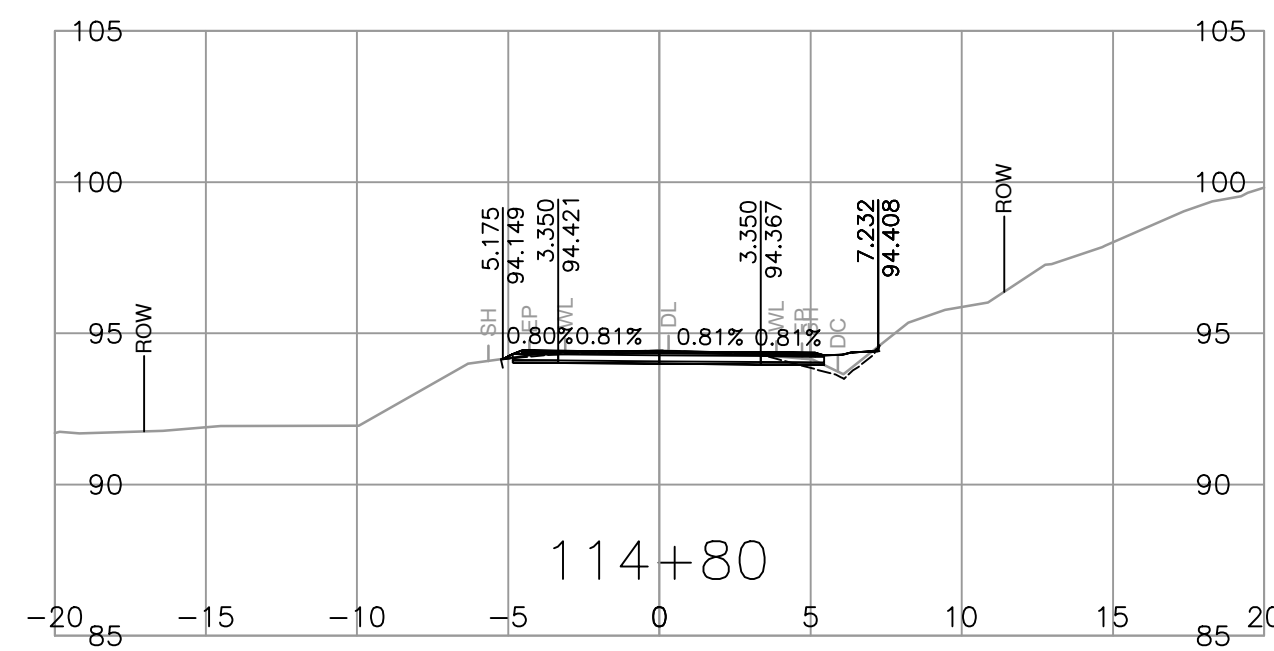
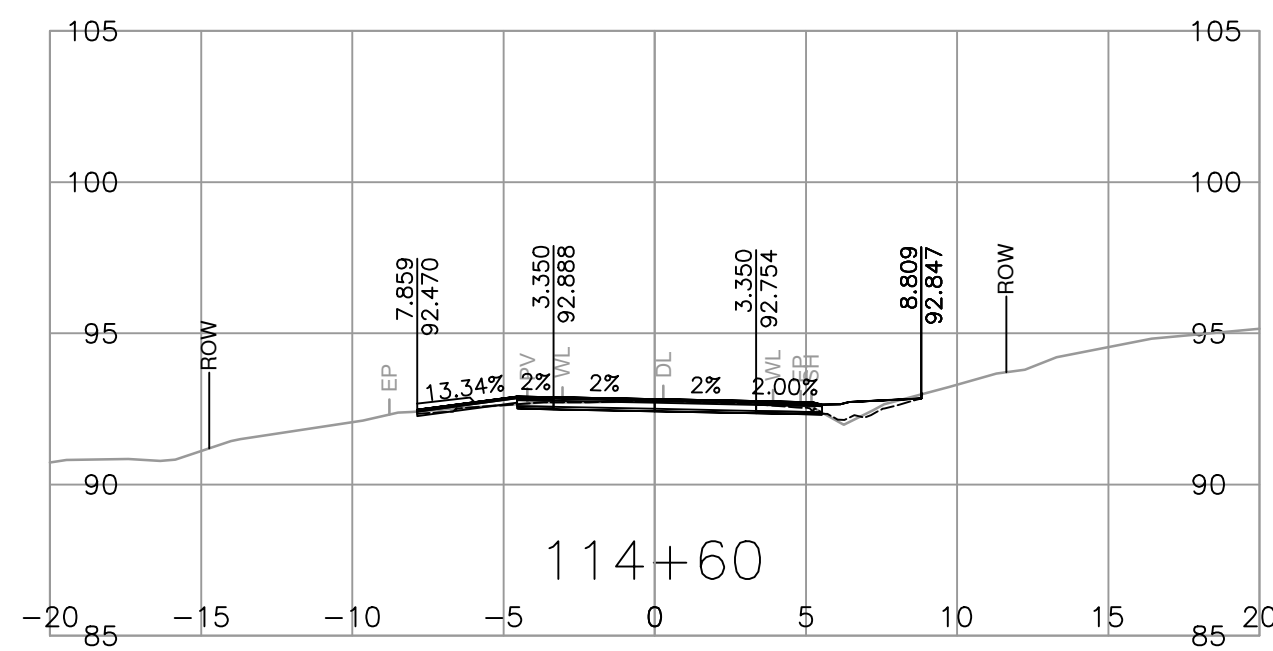
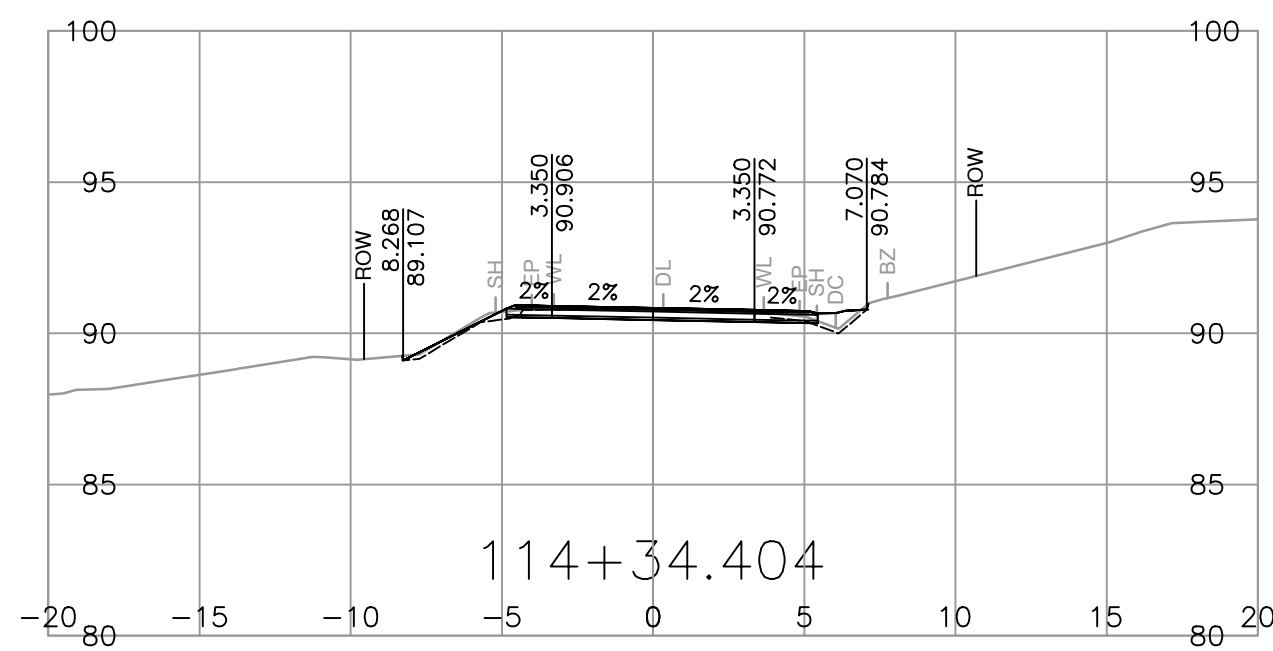
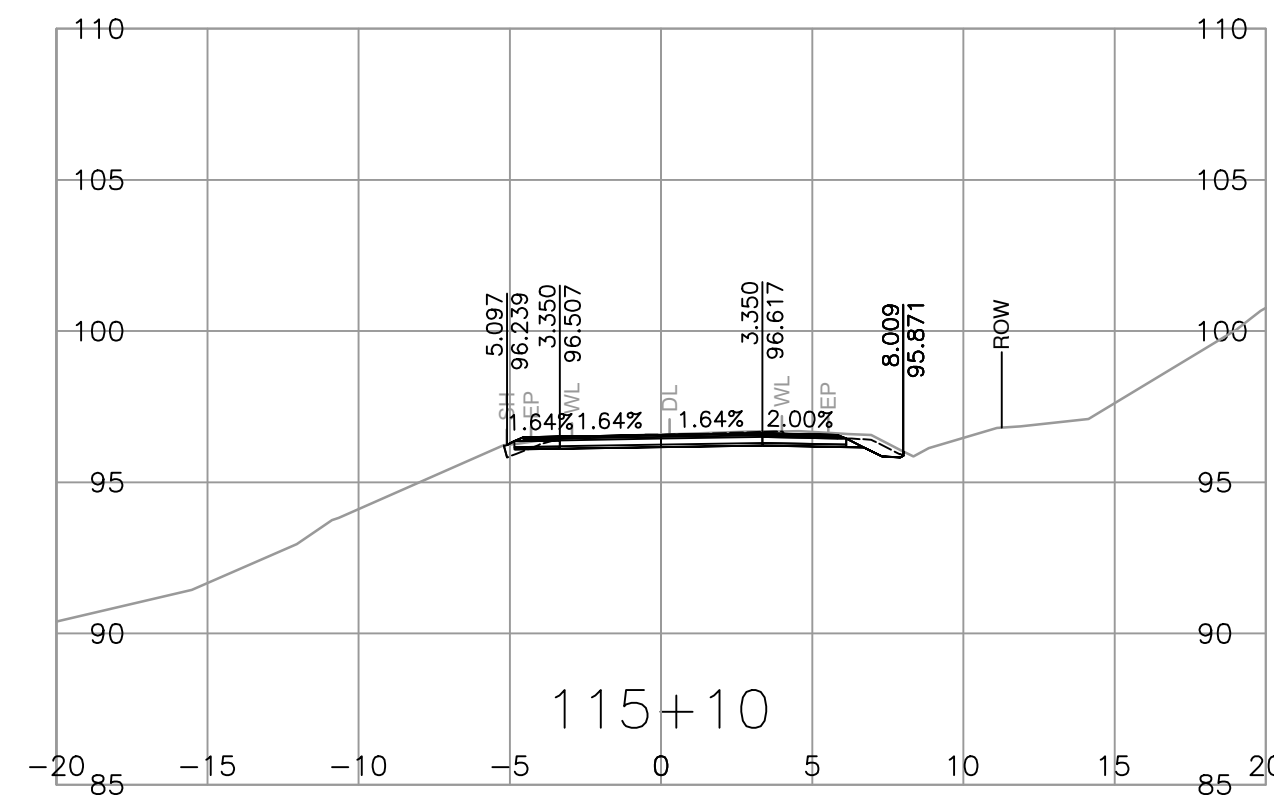
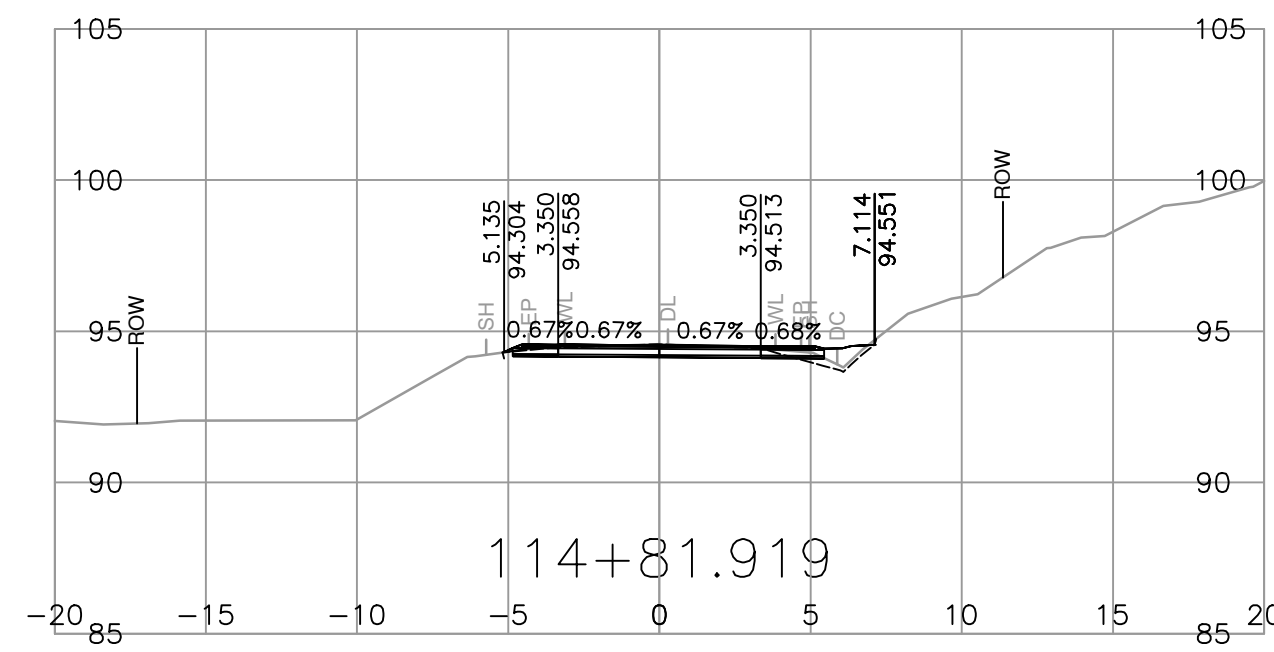
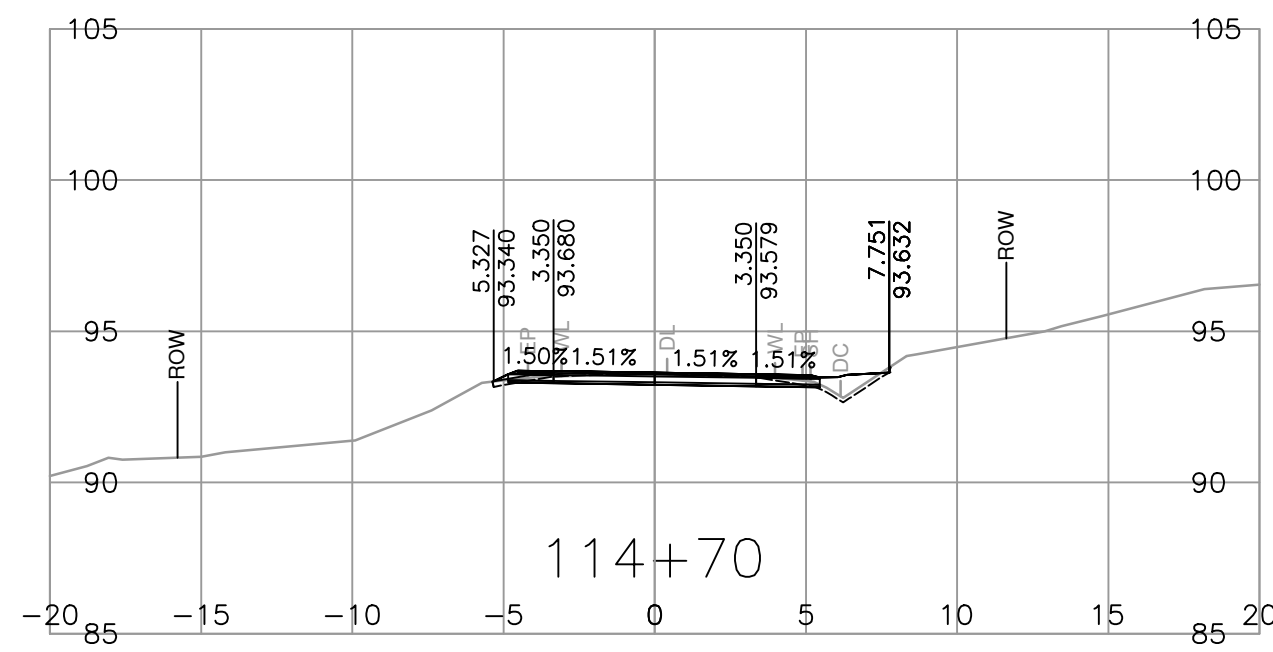
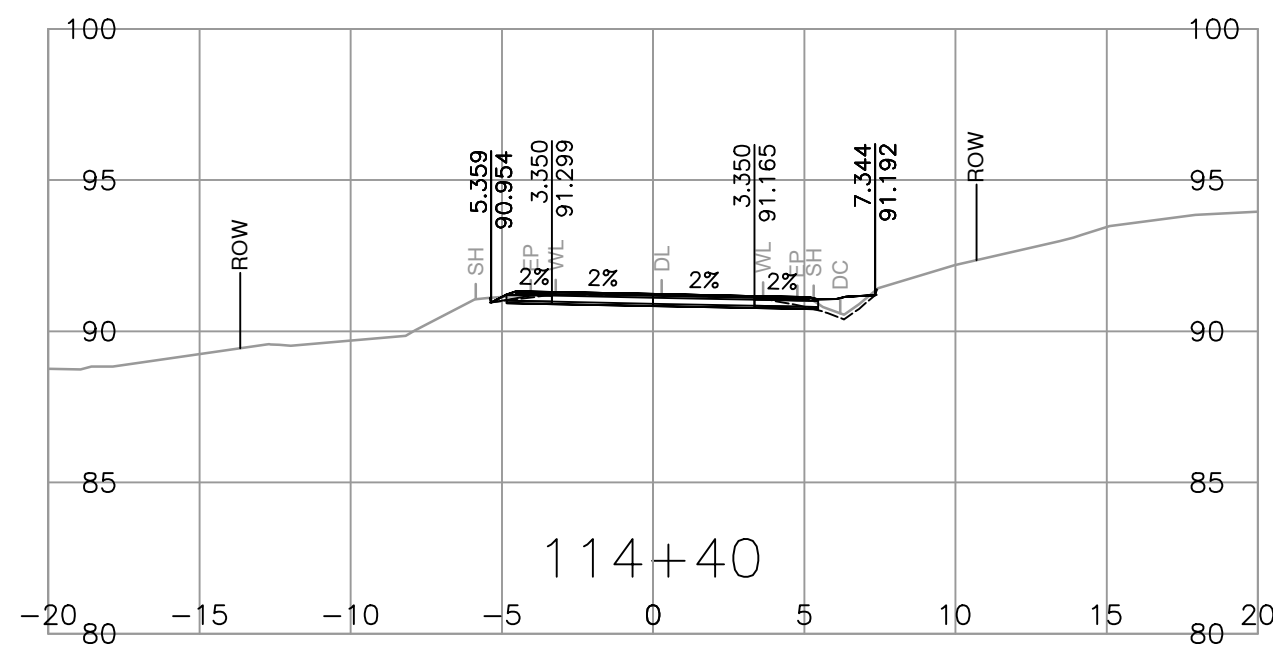
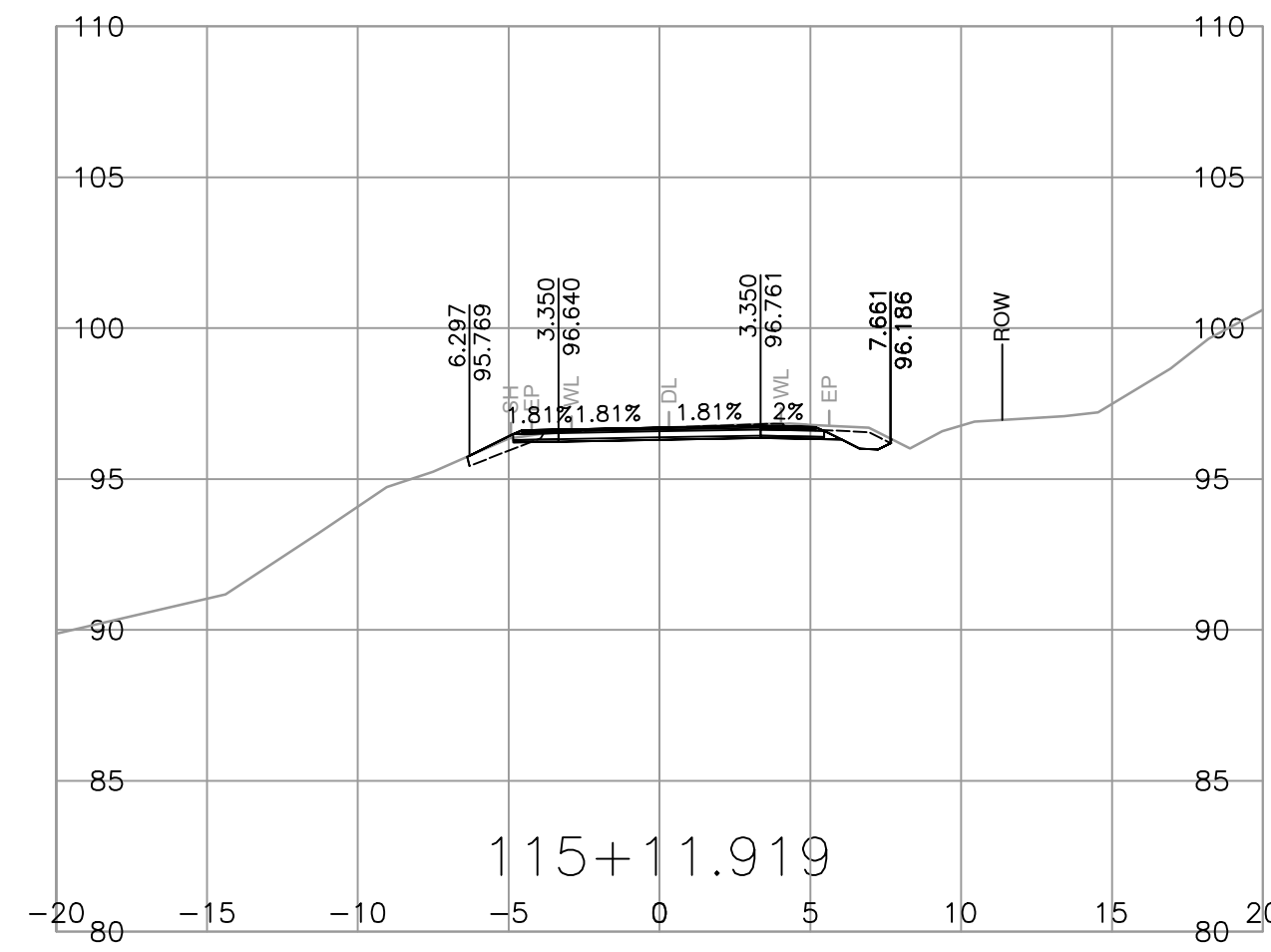
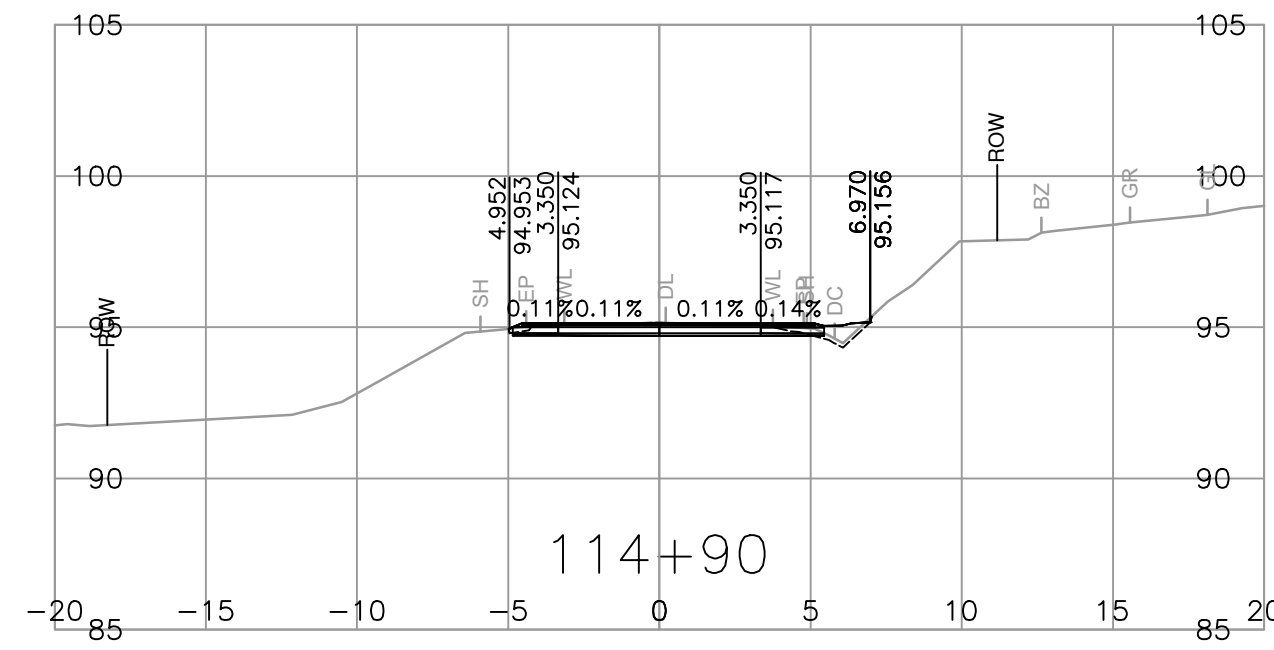
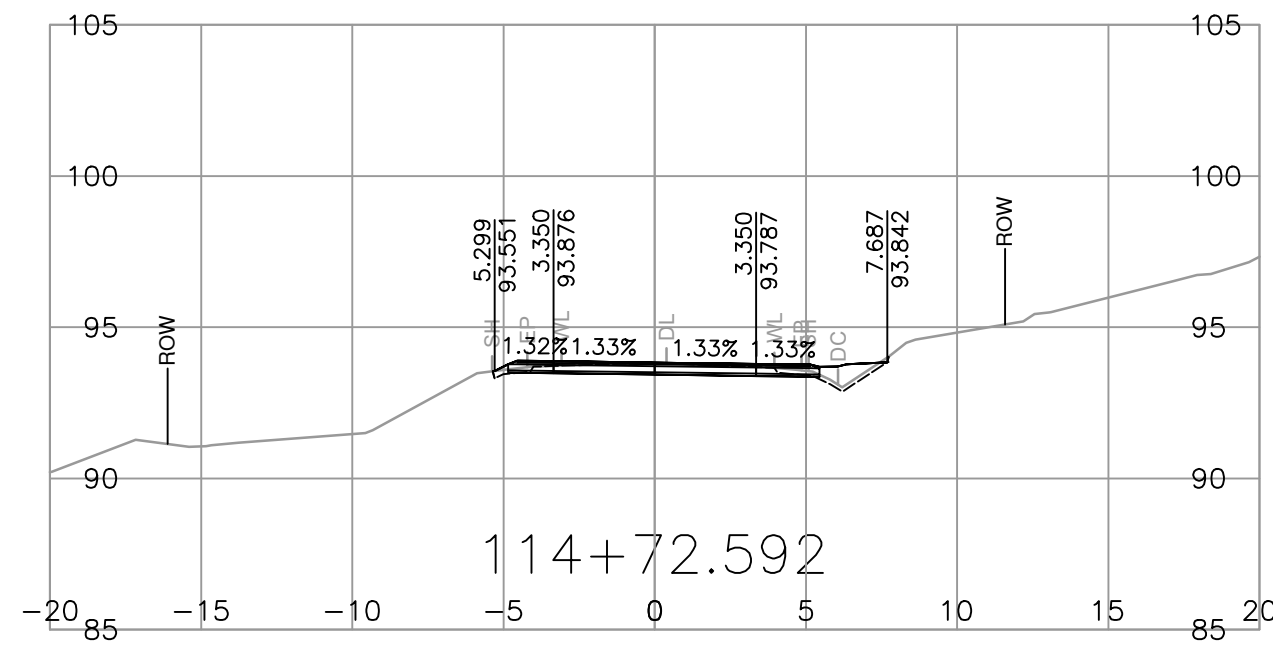
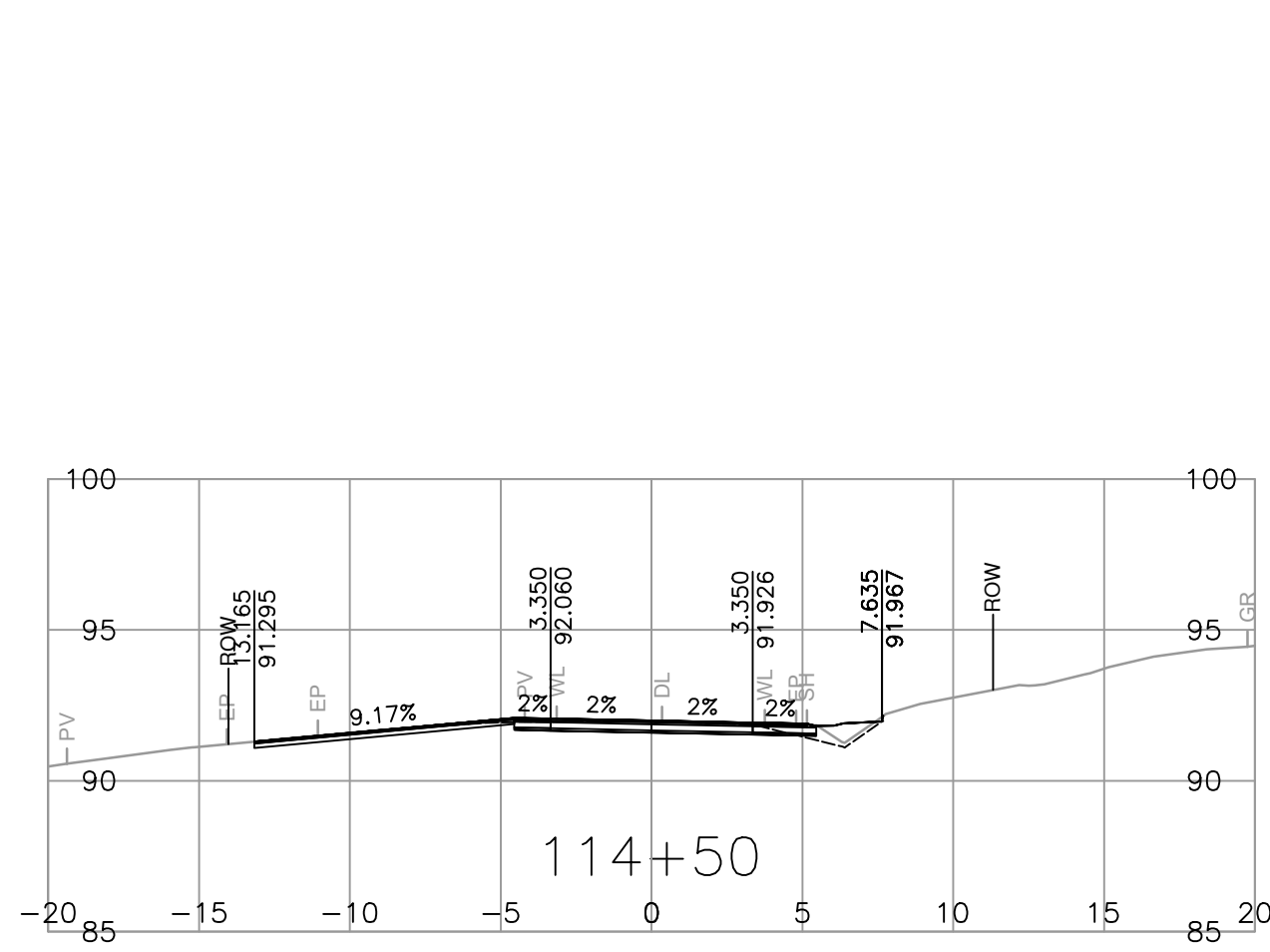

<p>SUITE 201, 8506 - 200 STREET LANGLEY, BRITISH COLUMBIA, V2Y 0M1 PH : 604.371.0091 FAX : 604.371.0098</p>	<p>SCALE 0 2 1:250 12m</p>	<p>CAD FILENAME R1-989-1000 PLOT DATE 2024-03-01</p>	<p>MINISTRY OF TRANSPORTATION AND INFRASTRUCTURE SOUTH COAST REGION VANCOUVER ISLAND DISTRICT</p>	<p>TEMPLATE CROSS SECTIONS FULFORD-GANGES ROAD IMPROVEMENT SEAVIEW AVENUE TO CRANBERRY ROAD</p>															
	<table border="1"> <thead> <tr> <th>REV</th> <th>DATE</th> <th>REVISIONS</th> <th>NAME</th> </tr> </thead> <tbody> <tr><td> </td><td> </td><td> </td><td> </td></tr> <tr><td> </td><td> </td><td> </td><td> </td></tr> <tr><td> </td><td> </td><td> </td><td> </td></tr> </tbody> </table>	REV	DATE	REVISIONS	NAME													<p>DESIGNED <u>B. PEEBLES</u> DATE 2024-02-01 QUALITY CONTROL <u>Z. PENDON</u> DATE 2024-02-01 QUALITY ASSURANCE <u>A. SANTOS</u> DATE 2024-02-01 DRAWN <u>J. SHIM</u> DATE 2024-02-01</p>	<p>FILE NUMBER 32836 PROJECT NUMBER 16873-0001 REG 1 DRAWING NUMBER R1-989-1011</p>
REV	DATE	REVISIONS	NAME																

PLOT DATE: 2024/03/01 G:\Projects\32000\32836_MoTL_Fulford_Ganges_Road_Widening\02_CADD\DrawingProduction\1000_DesignSections\R1-989-1000.dwg

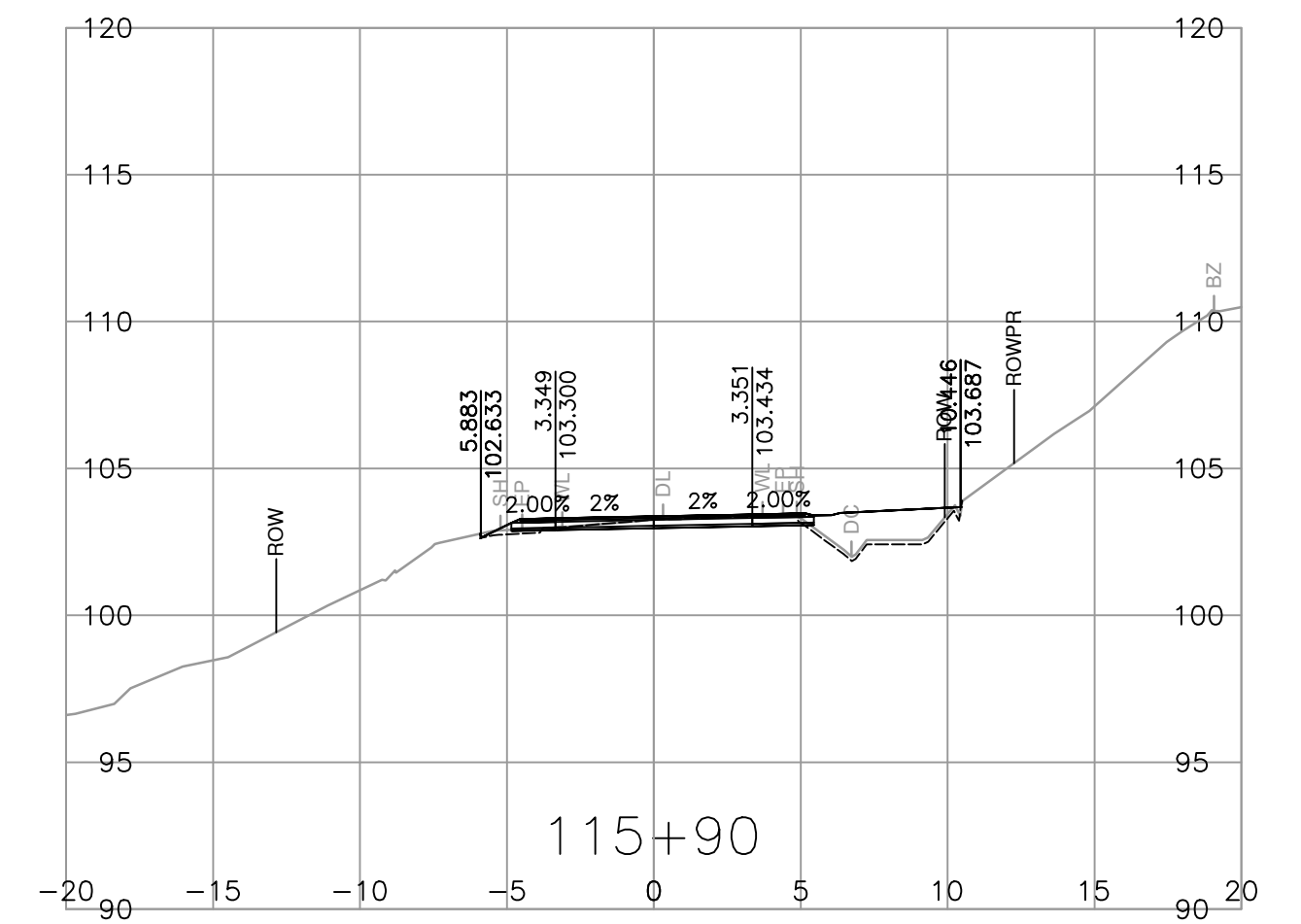
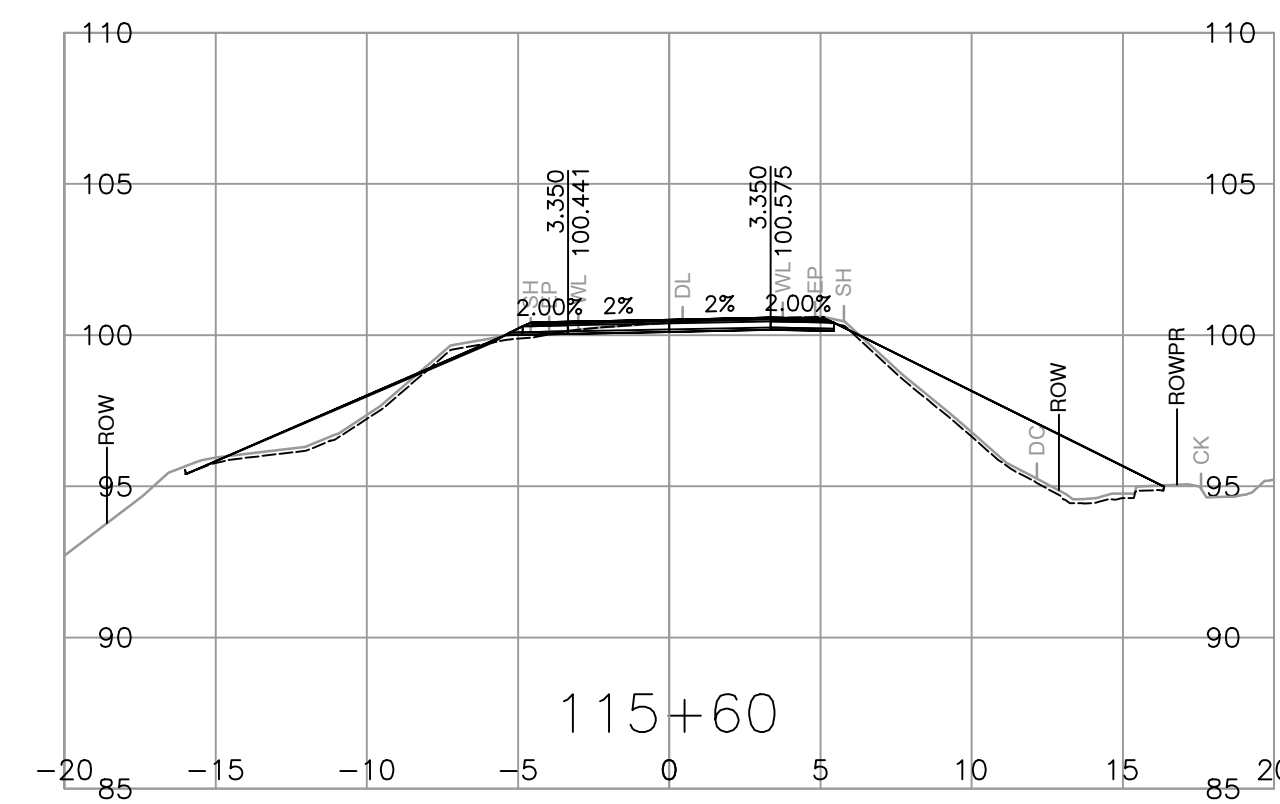
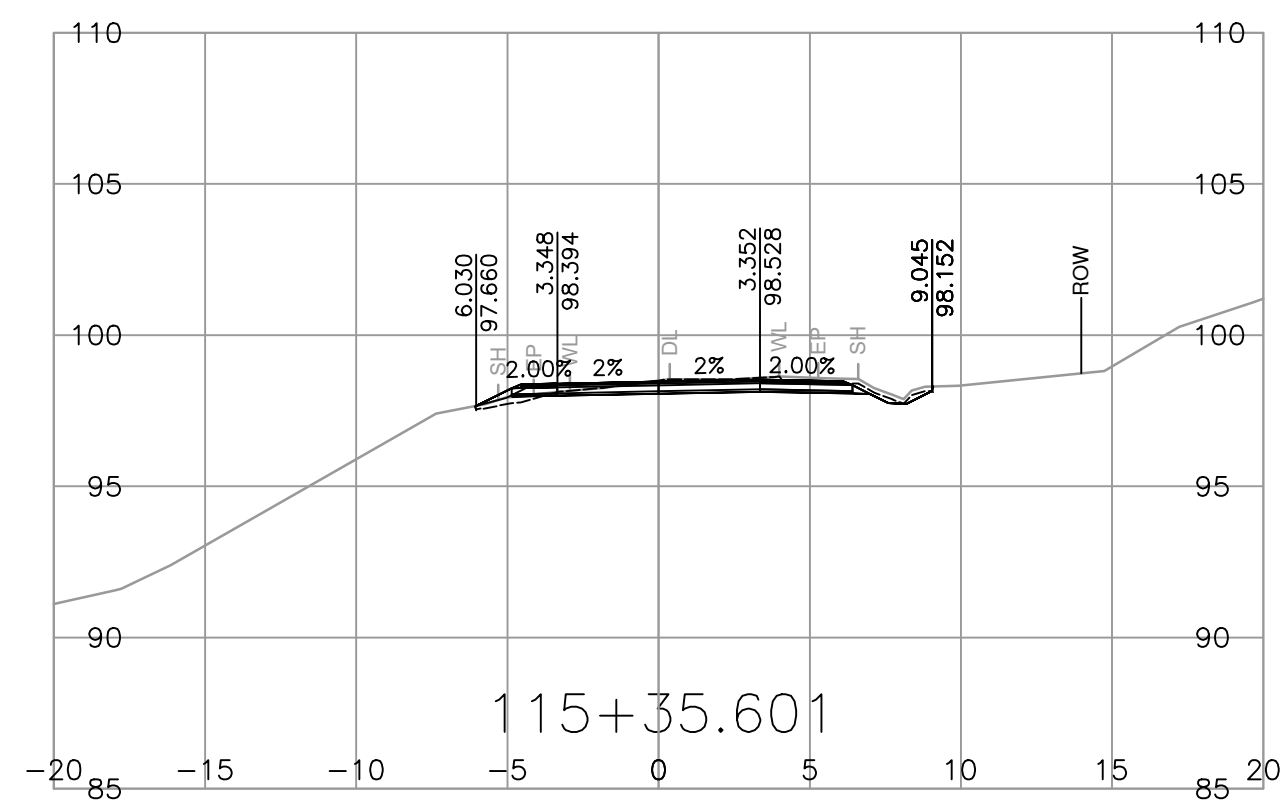
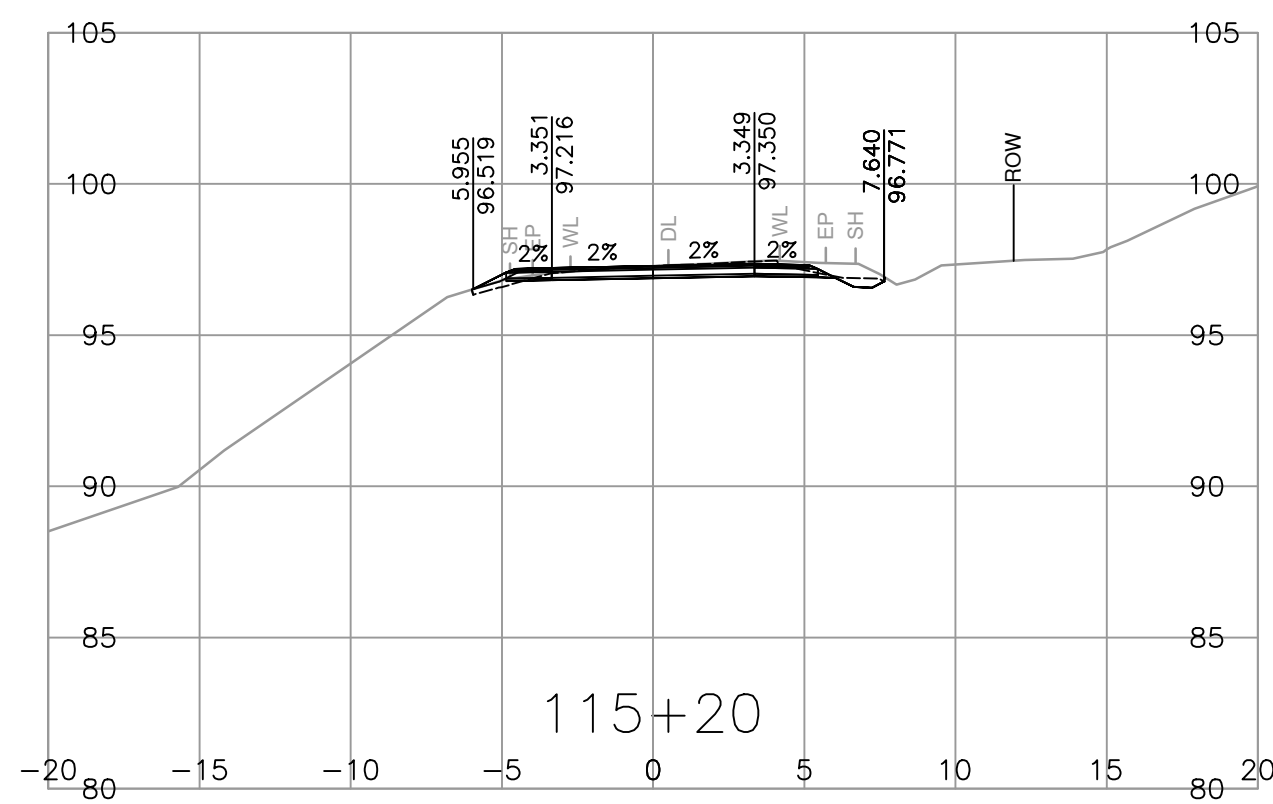
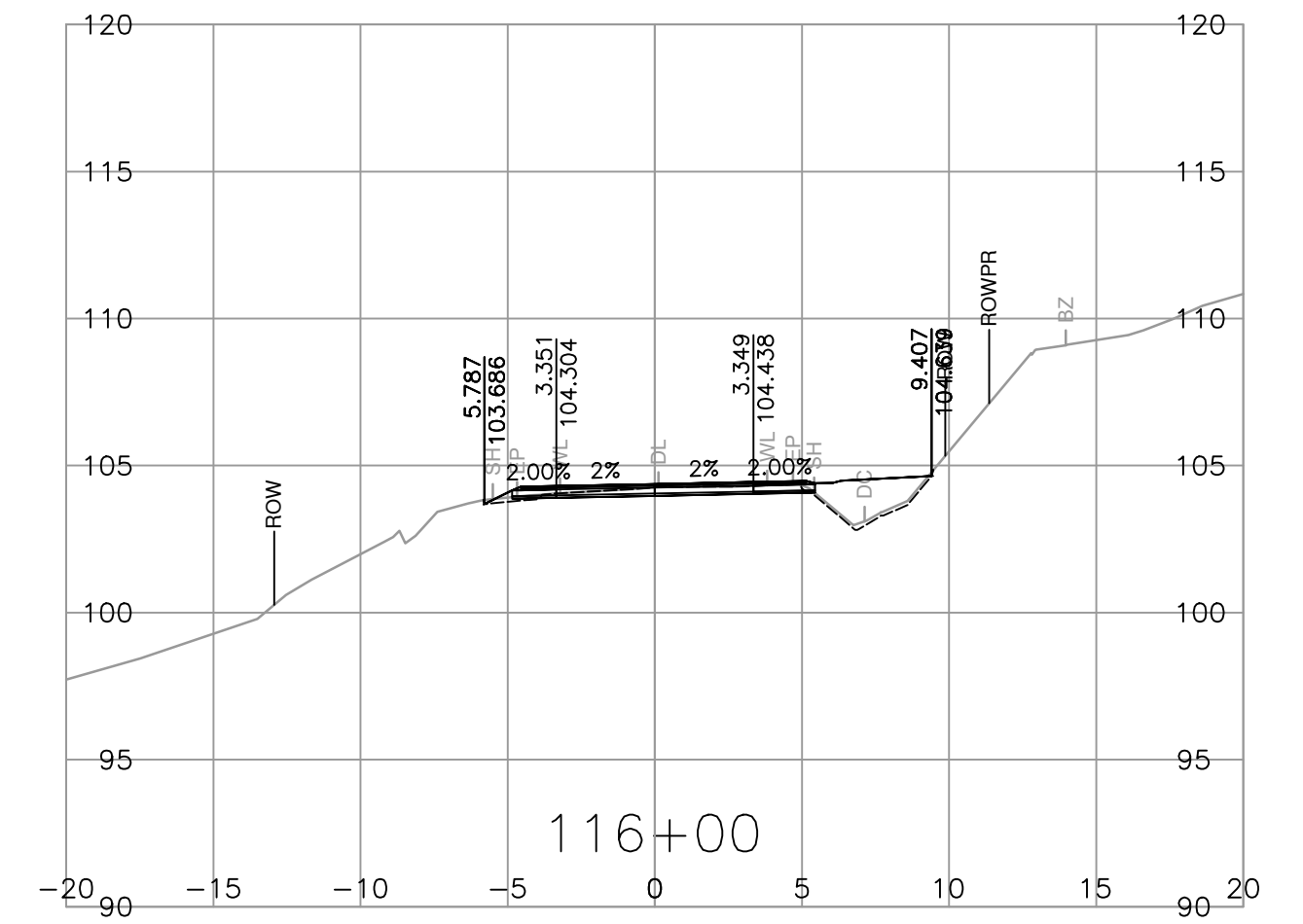
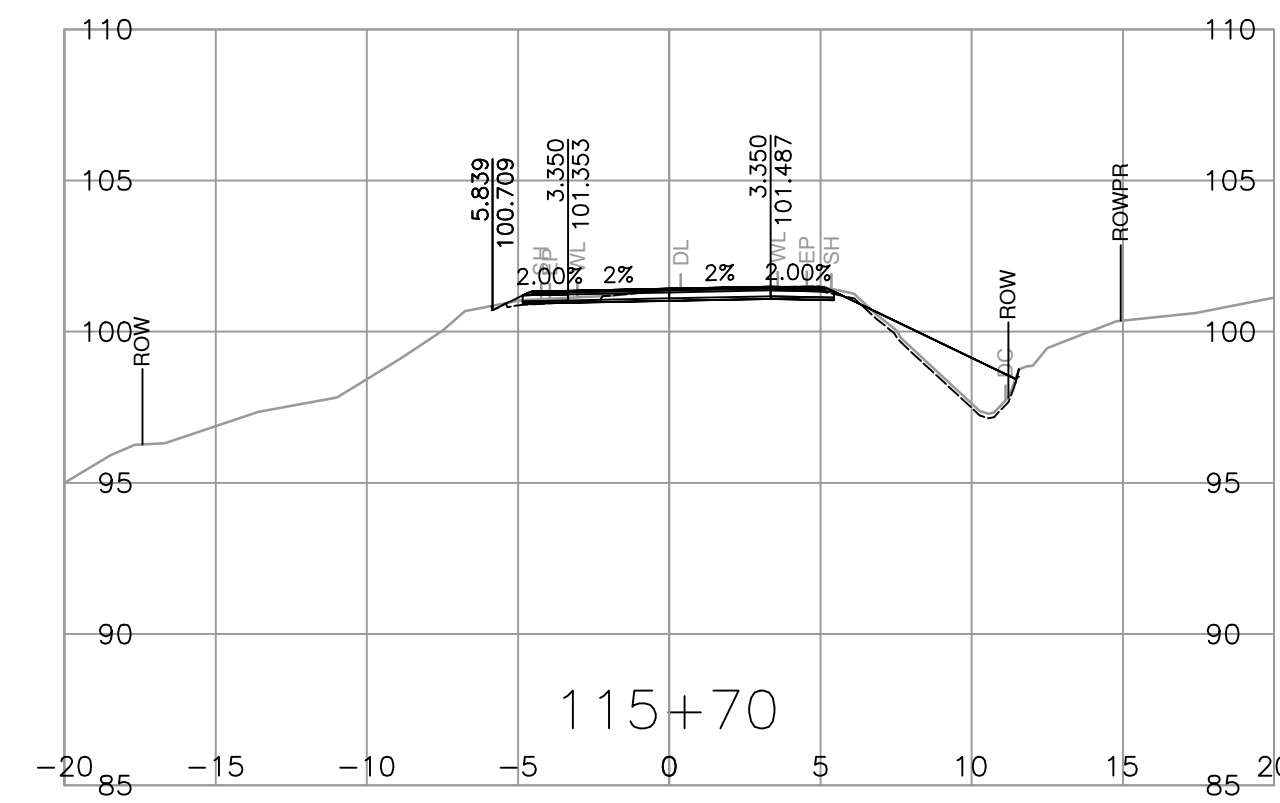
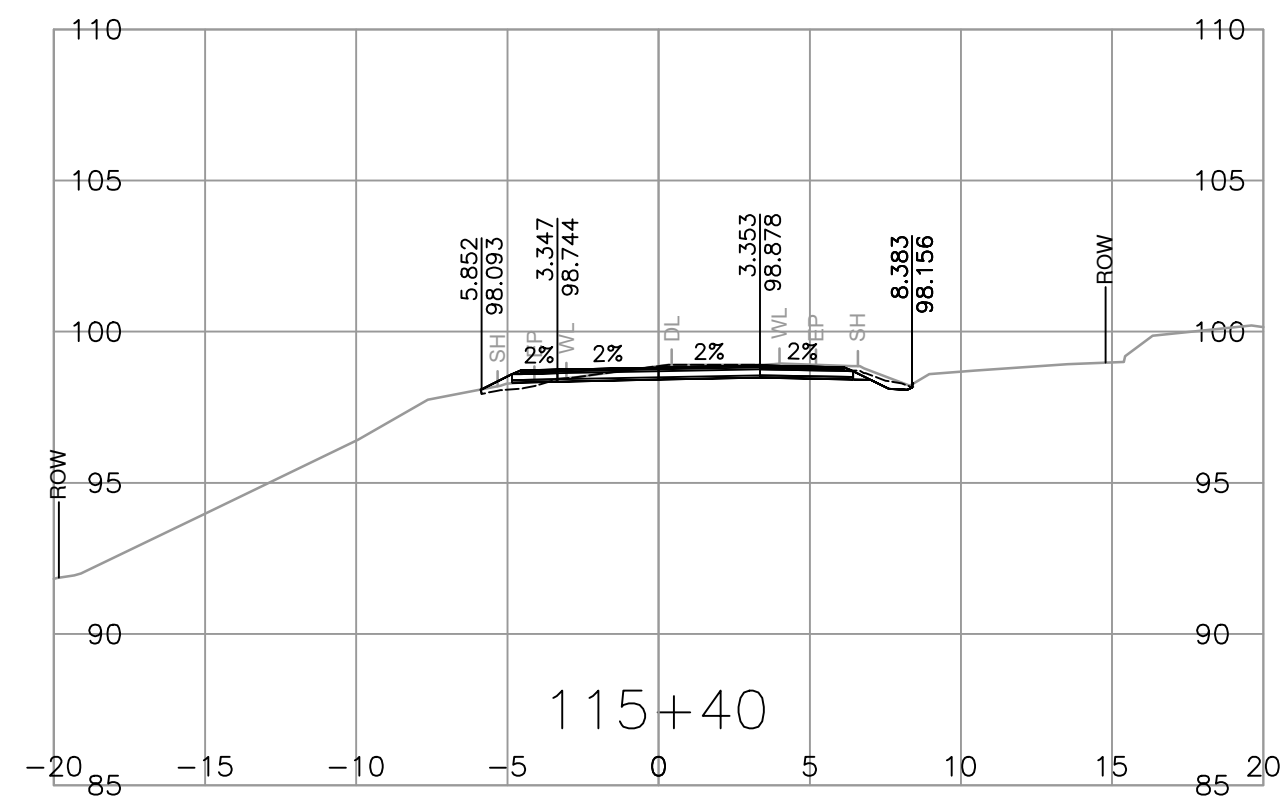
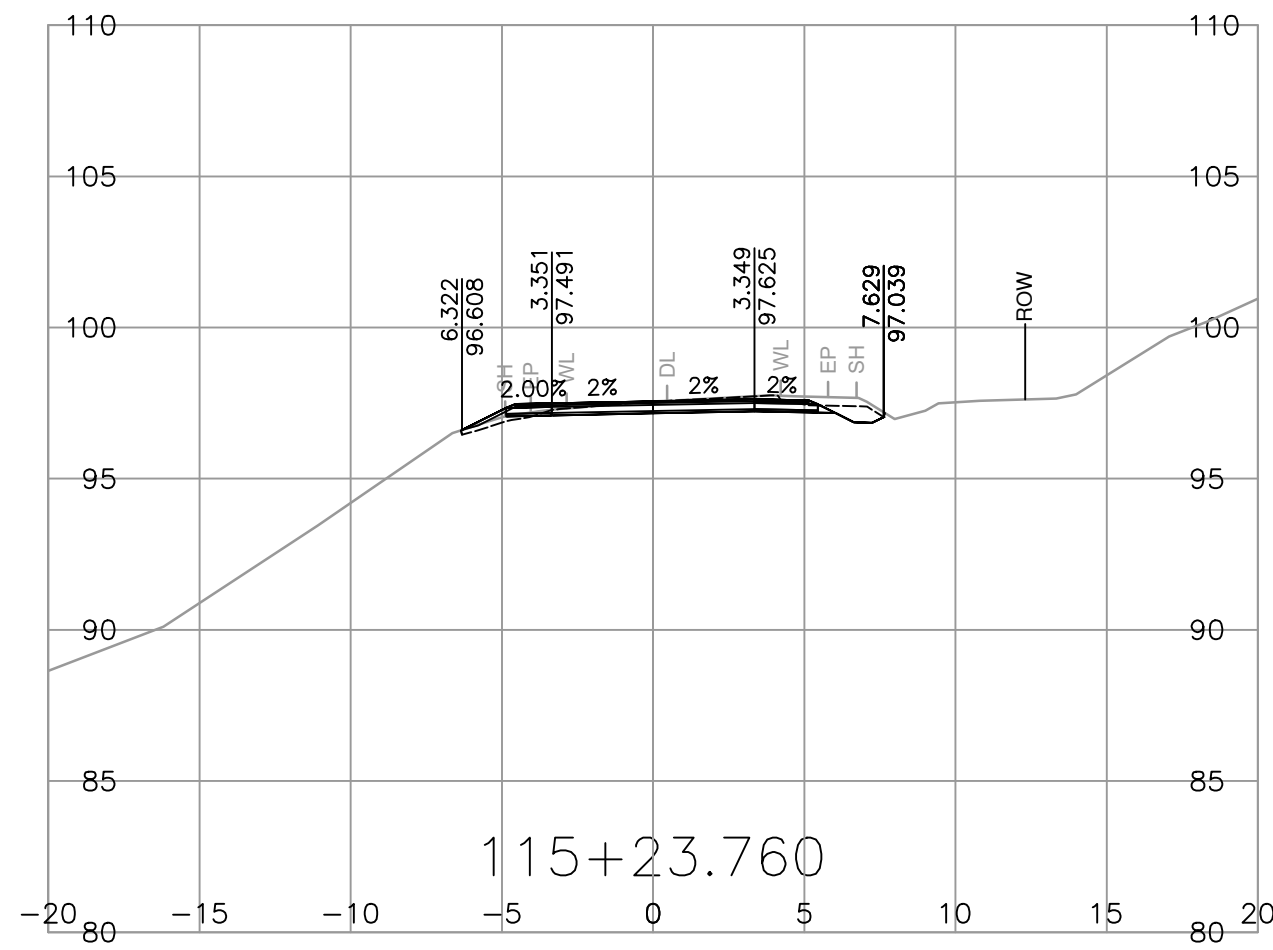
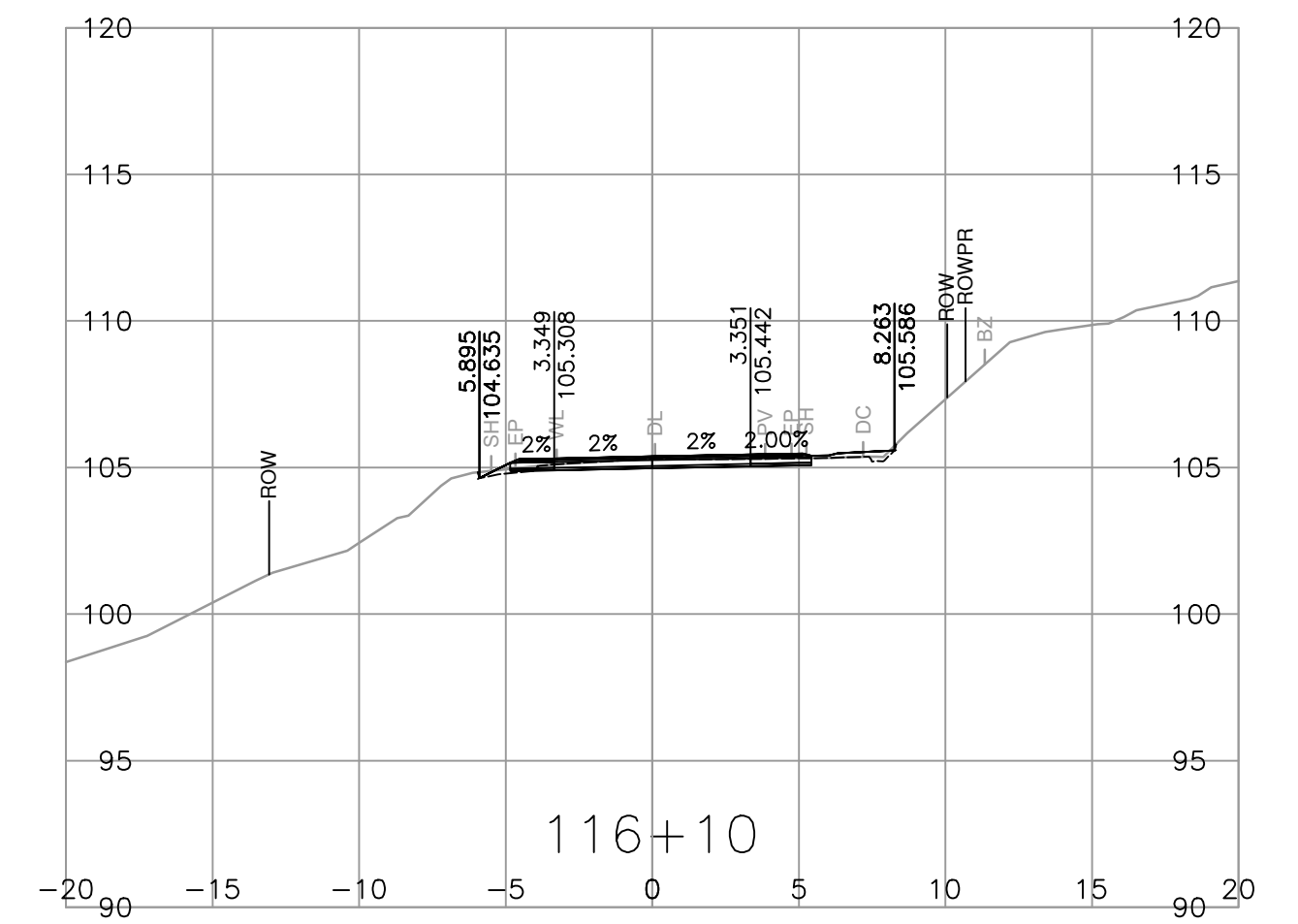
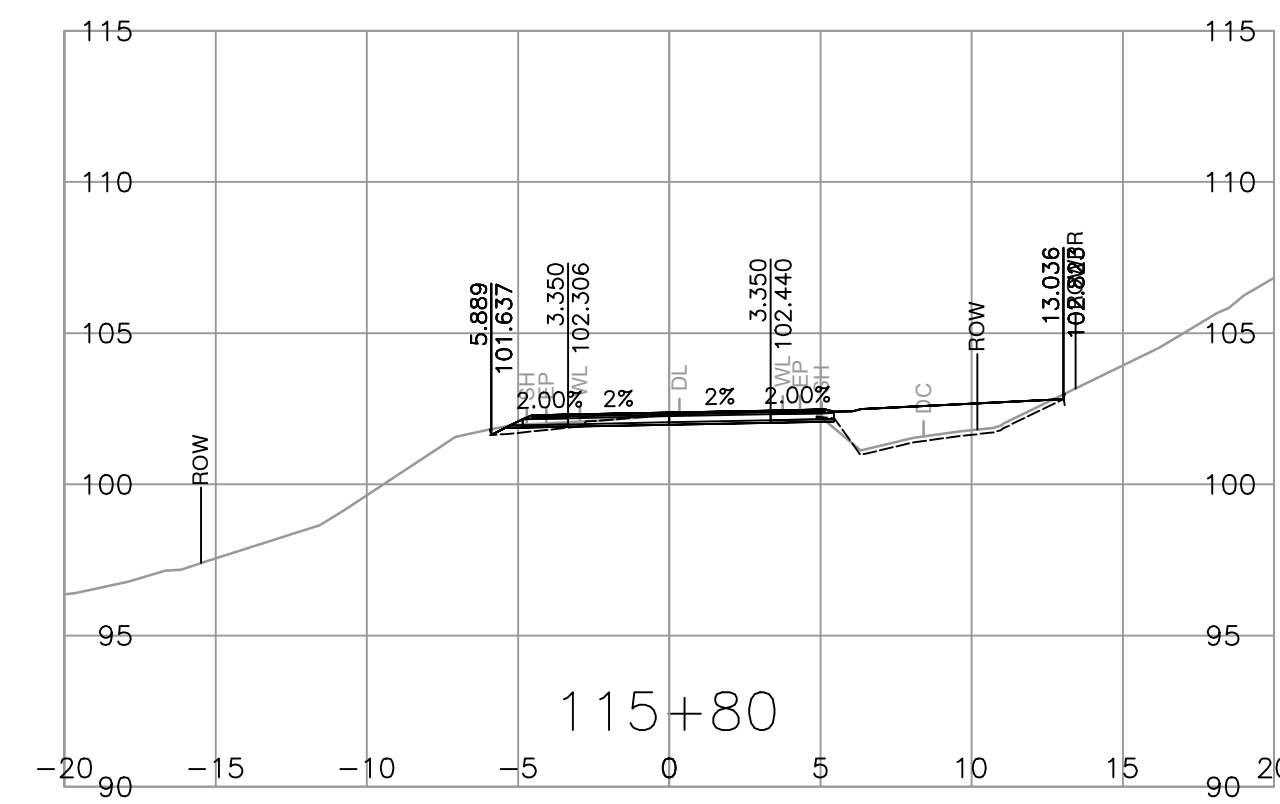
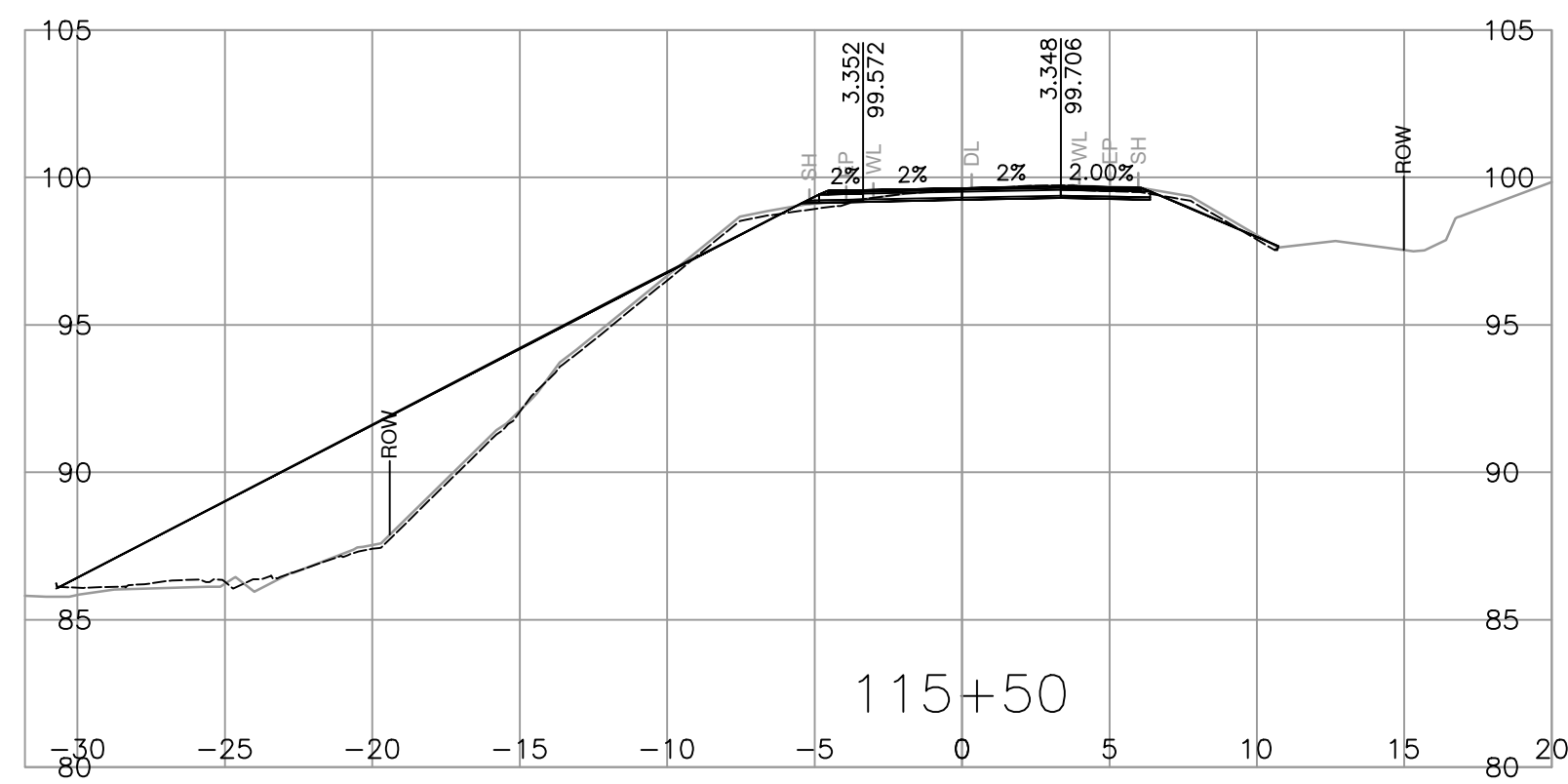
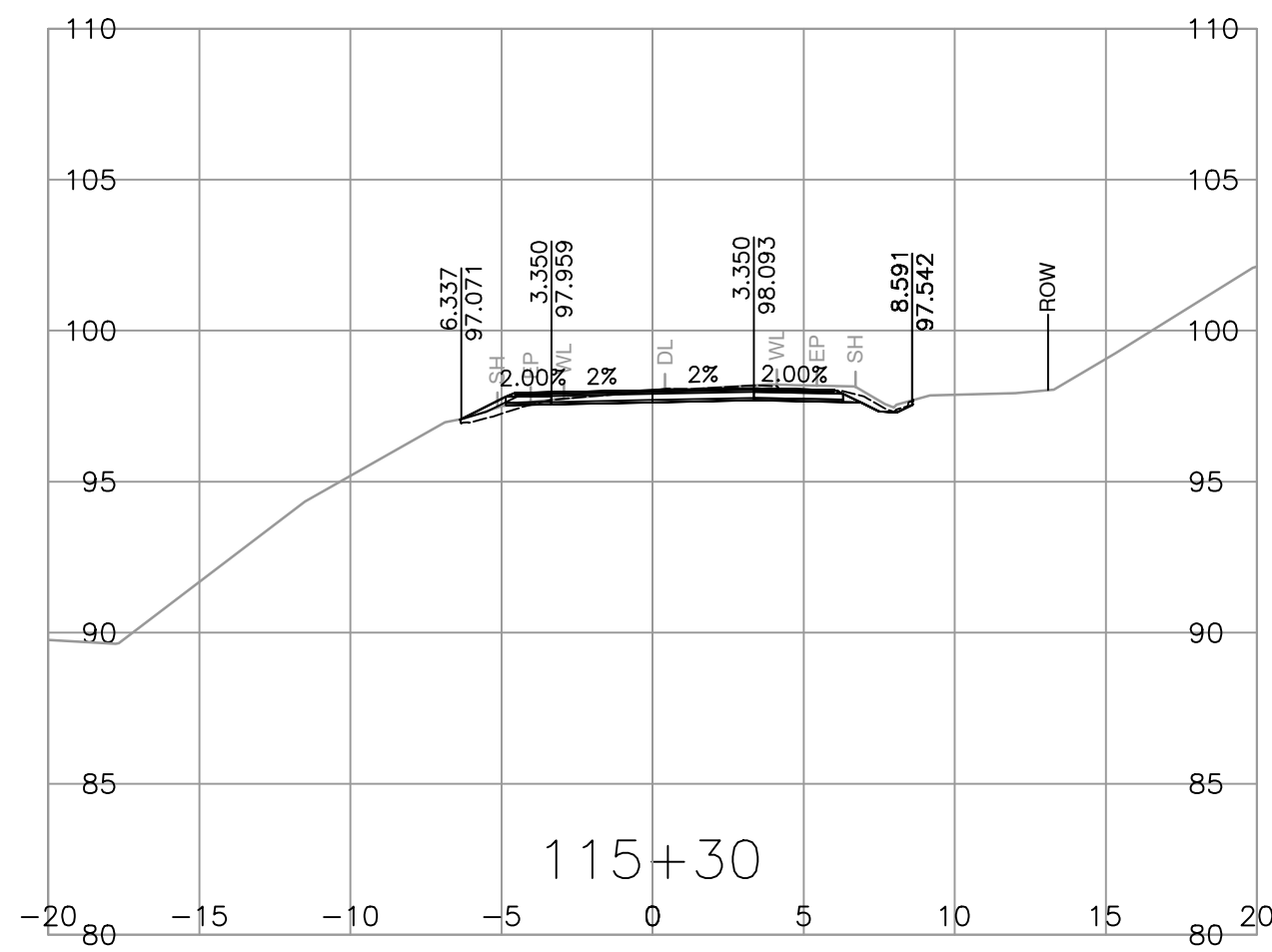

<p>SUITE 201, 8506 - 200 STREET LANGLEY, BRITISH COLUMBIA, V2Y 0M1 PH : 604.371.0091 FAX : 604.371.0098</p>	<p>SCALE 0 2 1:250 12m</p>	<p>CAD FILENAME R1-989-1000 PLOT DATE 2024-03-01</p>	<p>MINISTRY OF TRANSPORTATION AND INFRASTRUCTURE SOUTH COAST REGION VANCOUVER ISLAND DISTRICT</p>	<p>DESIGNED <u>B. PEEBLES</u> DATE 2024-02-01 QUALITY CONTROL <u>Z. PENDON</u> DATE 2024-02-01 QUALITY ASSURANCE <u>A. SANTOS</u> DATE 2024-02-01 DRAWN <u>J. SHIM</u> DATE 2024-02-01</p>		<p>FILE NUMBER 32836 PROJECT NUMBER 16873-0001 REG 1 DRAWING NUMBER R1-989-1012</p>																	
	<table border="1"> <thead> <tr> <th>REV</th> <th>DATE</th> <th>REVISIONS</th> <th>NAME</th> </tr> </thead> <tbody> <tr><td> </td><td> </td><td> </td><td> </td></tr> <tr><td> </td><td> </td><td> </td><td> </td></tr> <tr><td> </td><td> </td><td> </td><td> </td></tr> </tbody> </table>	REV	DATE	REVISIONS	NAME													<p>SENIOR DESIGNER _____ DATE _____</p>	<p>L100</p>		<p>32836</p>	<p>16873-0001</p>	<p>1</p>
REV	DATE	REVISIONS	NAME																				

PLOT DATE: 2024/03/01 G:\Projects\32000\32800\Fulford_Ganges_Road_Widening\02_CADD\DrawingProduction\1000_DesignSections\R1-989-1000.dwg

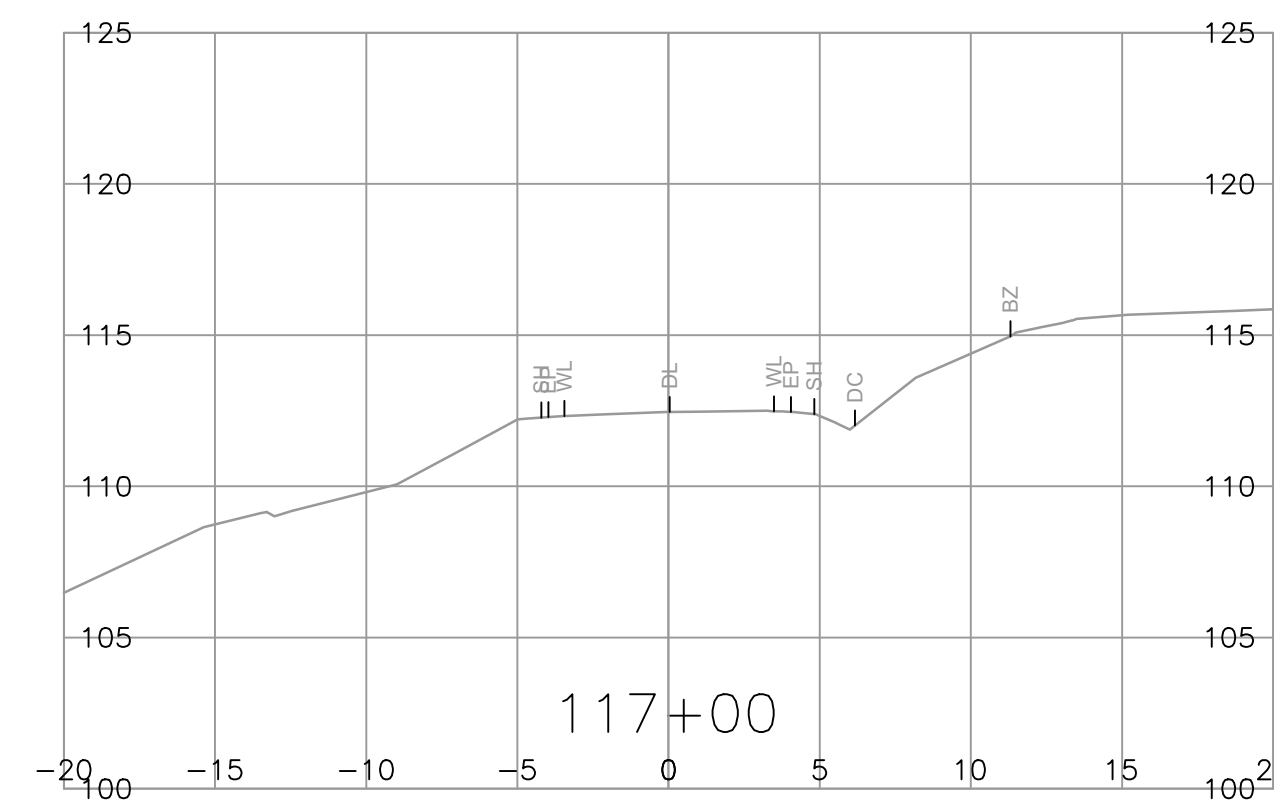
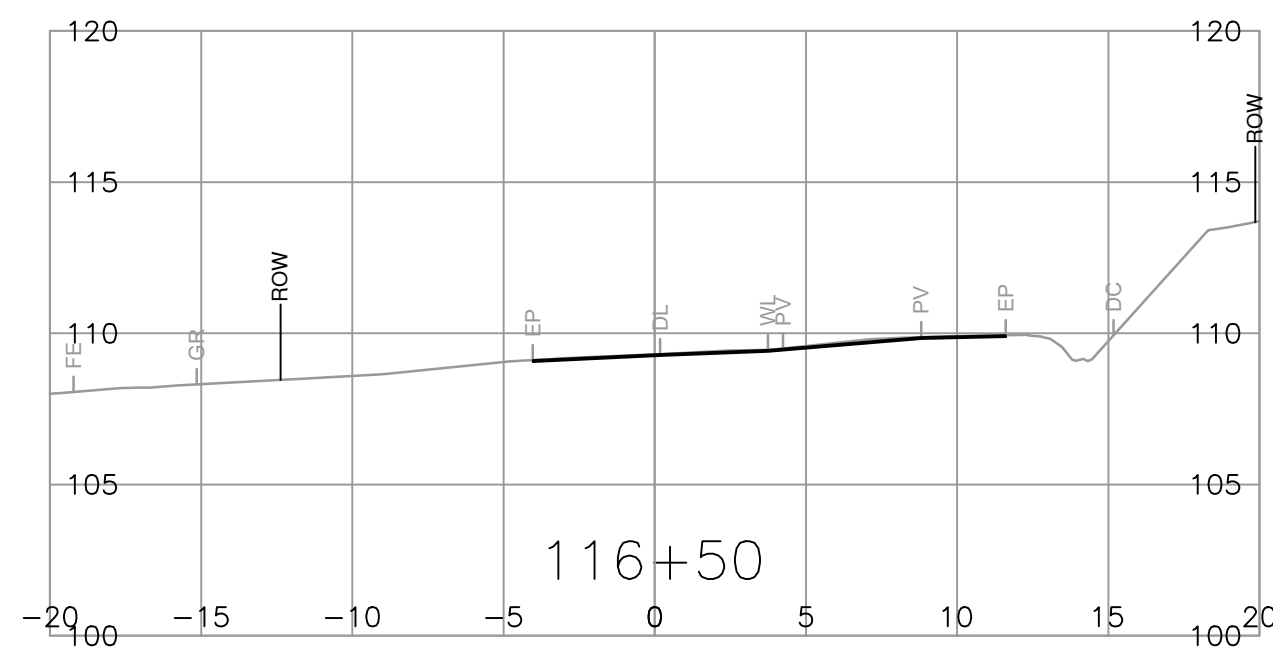
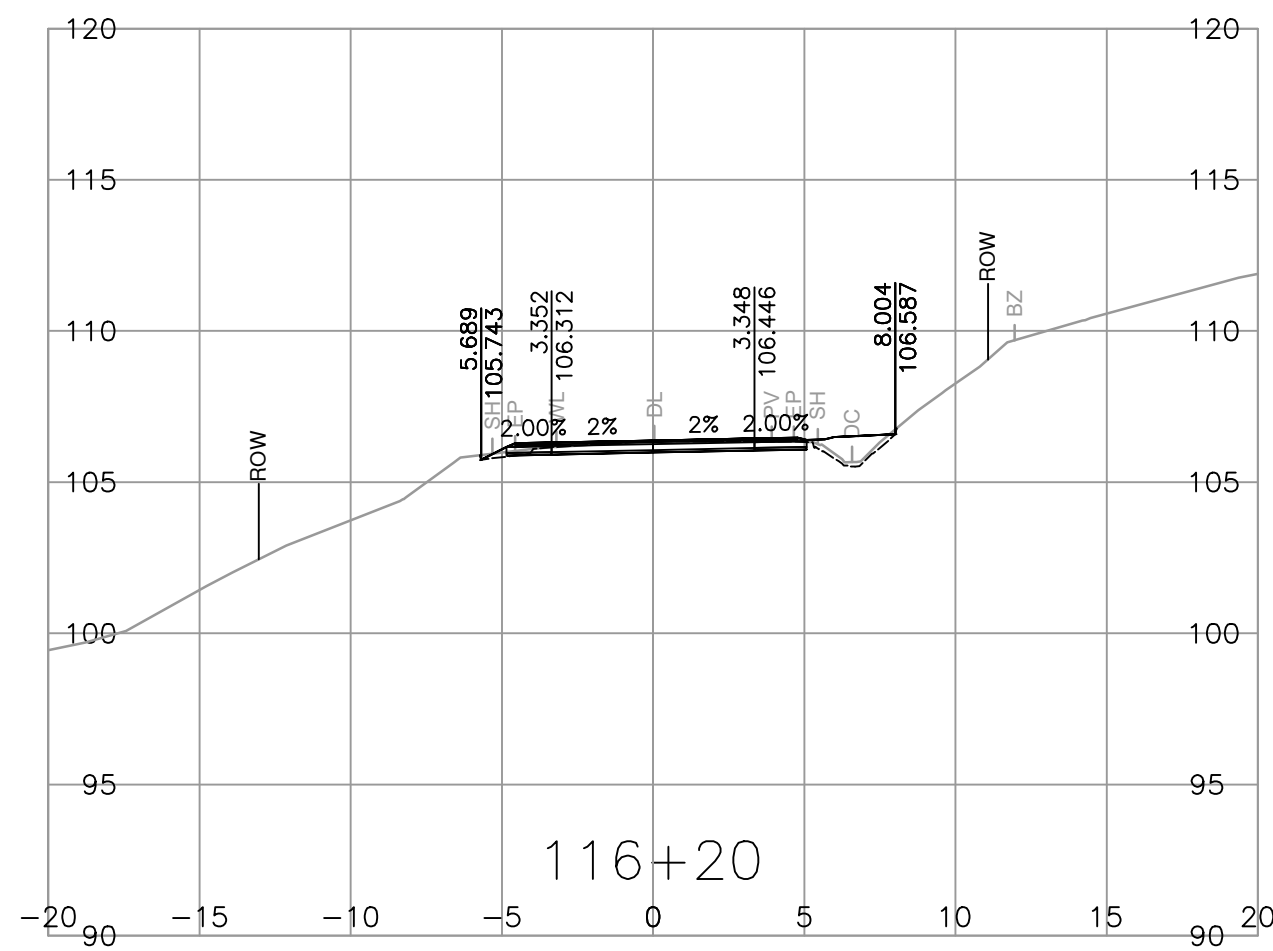
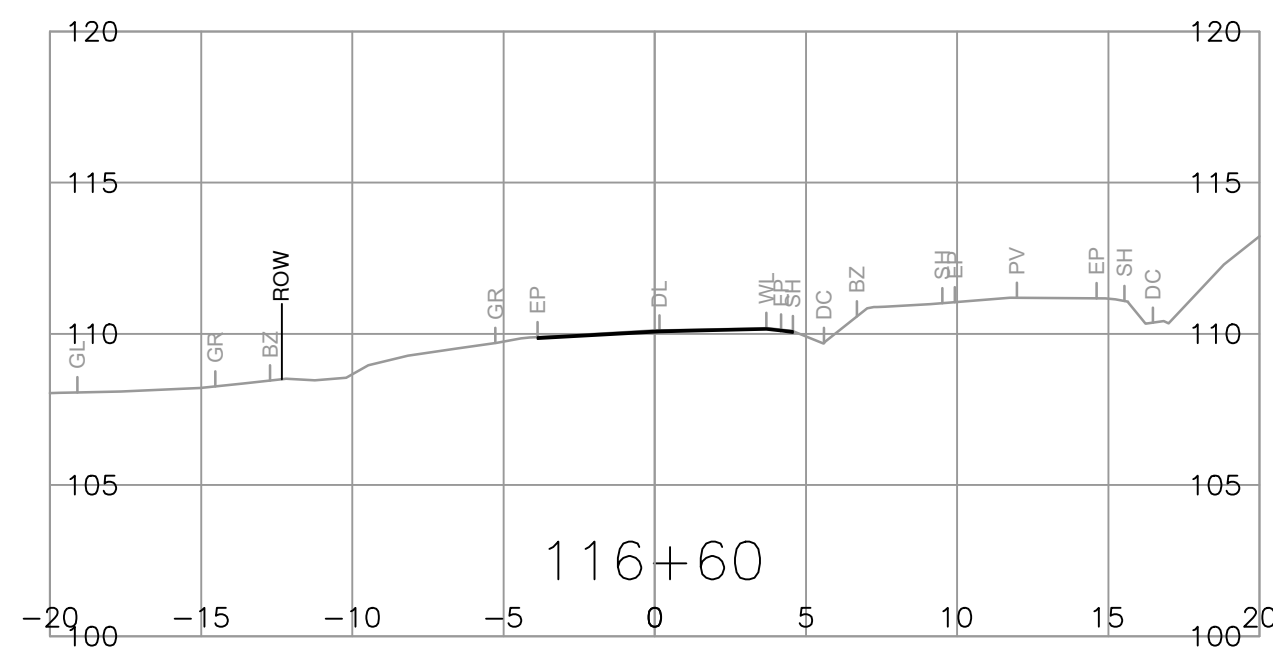
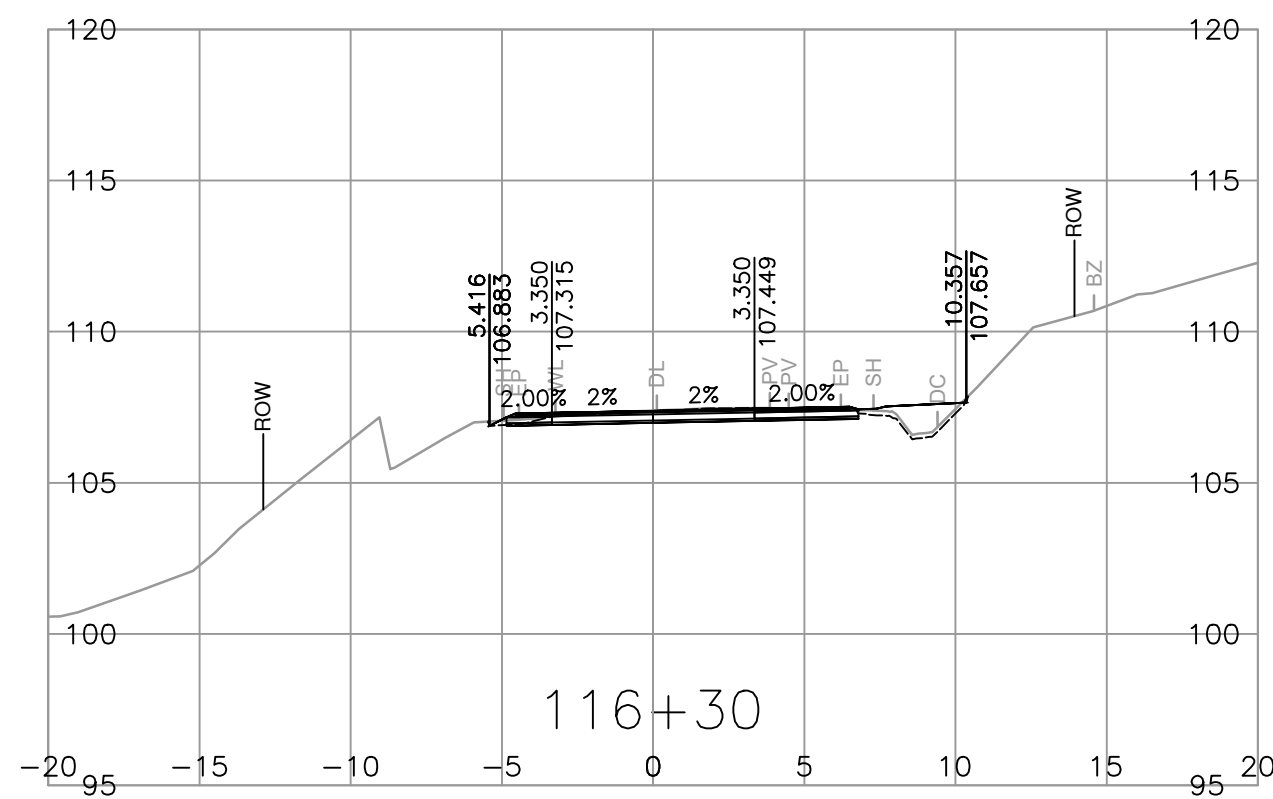
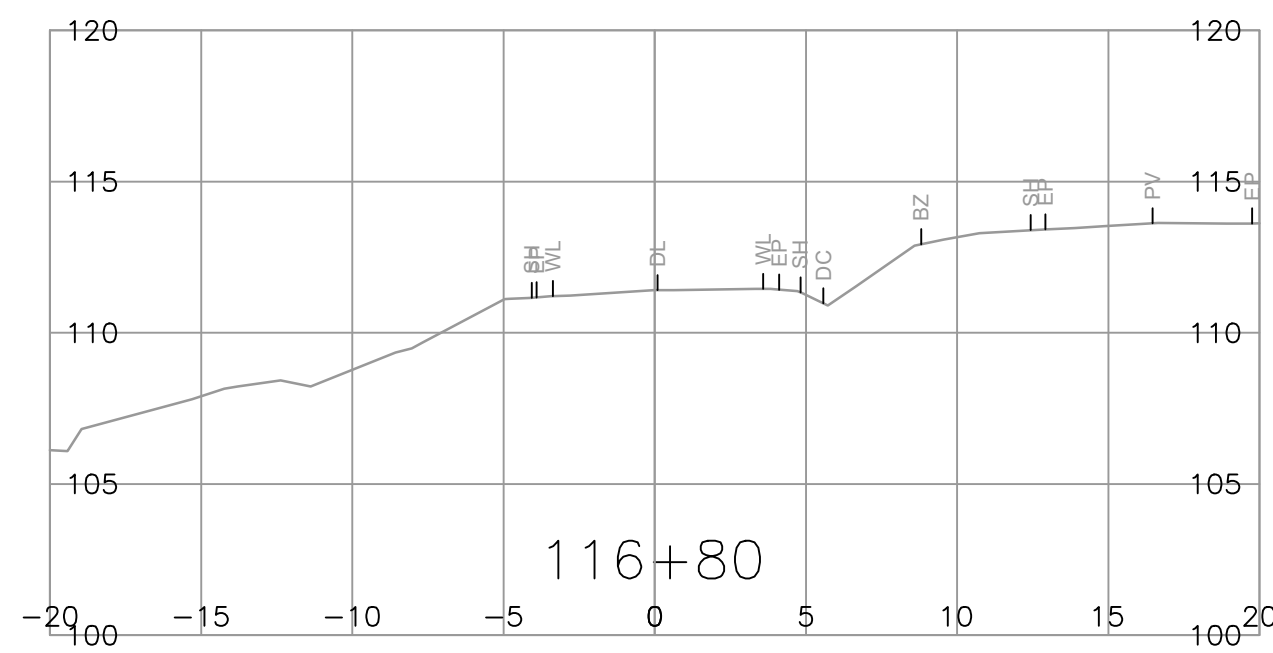
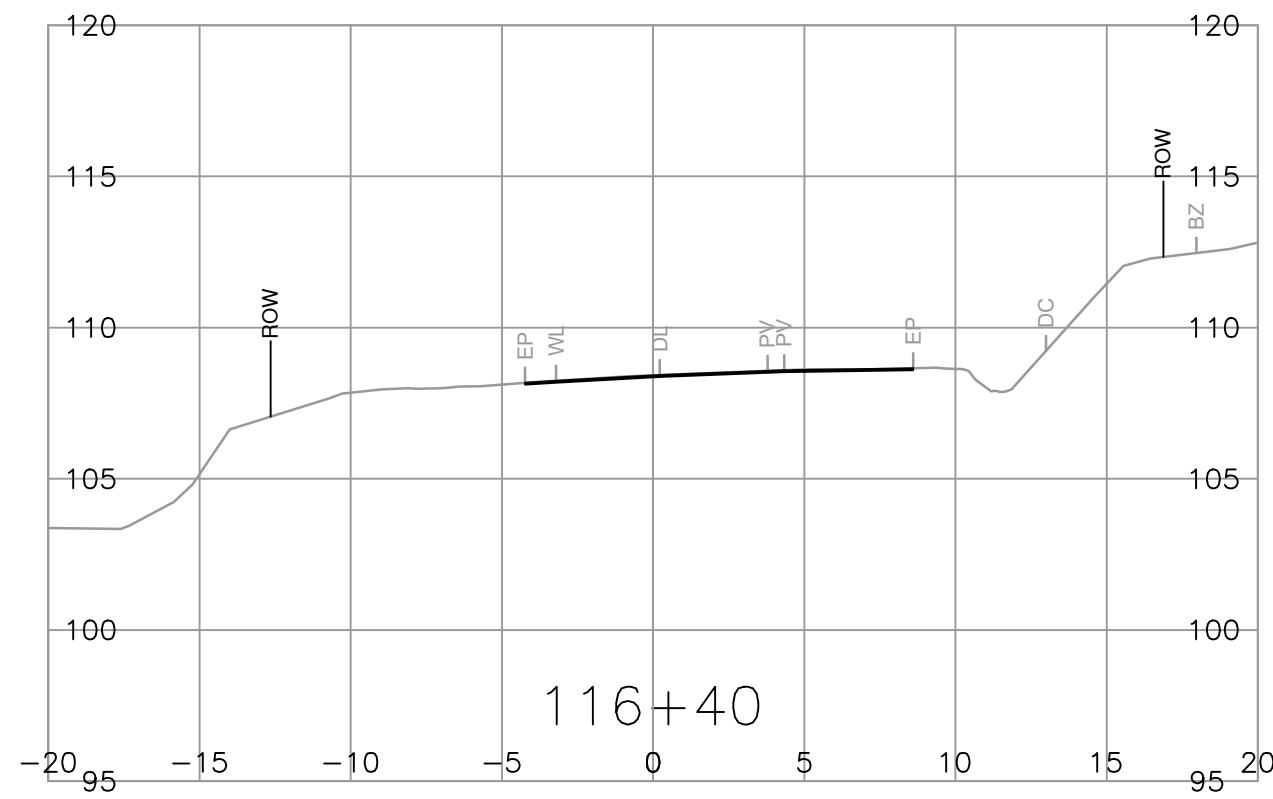

<p>SUITE 201, 8506 - 200 STREET LANGLEY, BRITISH COLUMBIA, V2Y 0M1 PH : 604.371.0091 FAX : 604.371.0098</p>	<p>SCALE 0 2 1:250 12m</p>	<p>CAD FILENAME R1-989-1000 PLOT DATE 2024-03-01</p>	<p>MINISTRY OF TRANSPORTATION AND INFRASTRUCTURE SOUTH COAST REGION VANCOUVER ISLAND DISTRICT</p>	<p>TEMPLATE CROSS SECTIONS FULFORD-GANGES ROAD IMPROVEMENT SEAVIEW AVENUE TO CRANBERRY ROAD</p> <p>L100</p>																								
	<table border="1"> <thead> <tr> <th>REV</th> <th>DATE</th> <th>REVISIONS</th> <th>NAME</th> </tr> </thead> <tbody> <tr><td> </td><td> </td><td> </td><td> </td></tr> <tr><td> </td><td> </td><td> </td><td> </td></tr> <tr><td> </td><td> </td><td> </td><td> </td></tr> </tbody> </table>	REV	DATE	REVISIONS	NAME													<p>DESIGNED <u>B. PEEBLES</u> DATE 2024-02-01 QUALITY CONTROL <u>Z. PENDON</u> DATE 2024-02-01 QUALITY ASSURANCE <u>A. SANTOS</u> DATE 2024-02-01 DRAWN <u>J. SHIM</u> DATE 2024-02-01</p>	<table border="1"> <tr> <td>FILE NUMBER</td> <td>PROJECT NUMBER</td> <td>REG</td> <td>DRAWING NUMBER</td> <td>REV</td> </tr> <tr> <td>32836</td> <td>16873-0001</td> <td>1</td> <td>R1-989-1013</td> <td> </td> </tr> </table>	FILE NUMBER	PROJECT NUMBER	REG	DRAWING NUMBER	REV	32836	16873-0001	1	R1-989-1013
REV	DATE	REVISIONS	NAME																									
FILE NUMBER	PROJECT NUMBER	REG	DRAWING NUMBER	REV																								
32836	16873-0001	1	R1-989-1013																									

PLOT DATE: 2024/03/01 G:\Projects\32000\32836_MoTI_Fulford_Ganges_Road_Widening\02_CADD\DrawingProduction\1000_DesignSections\R1-989-1000.dwg

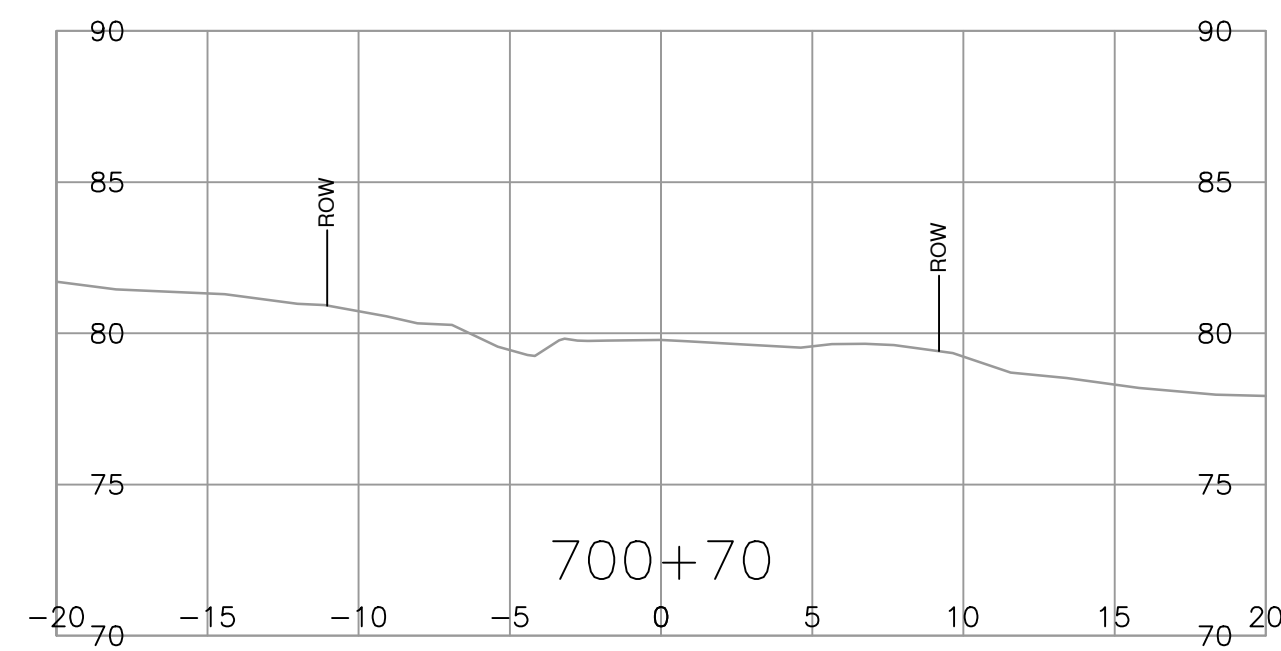
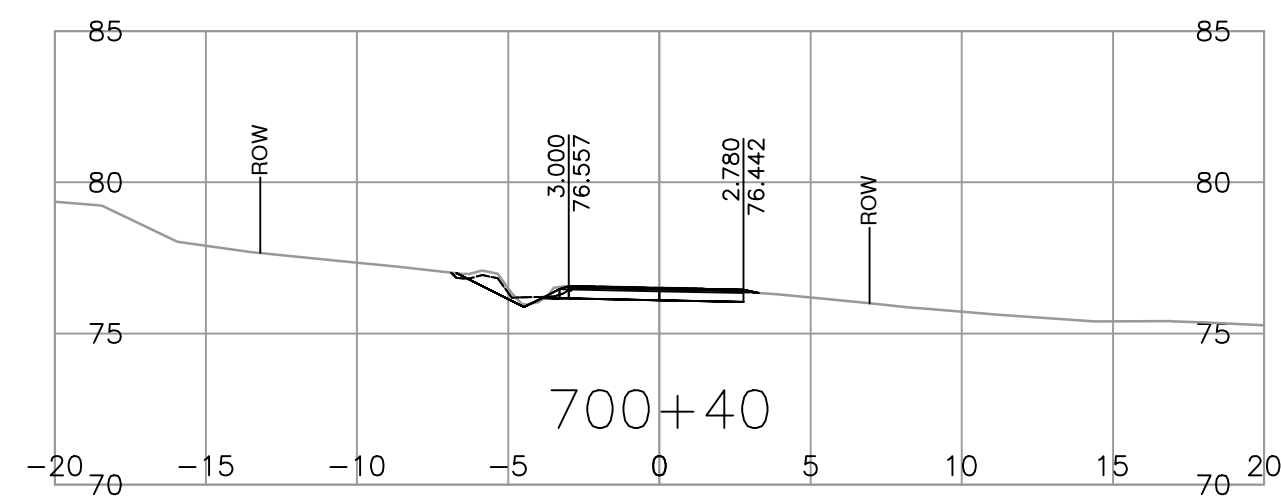
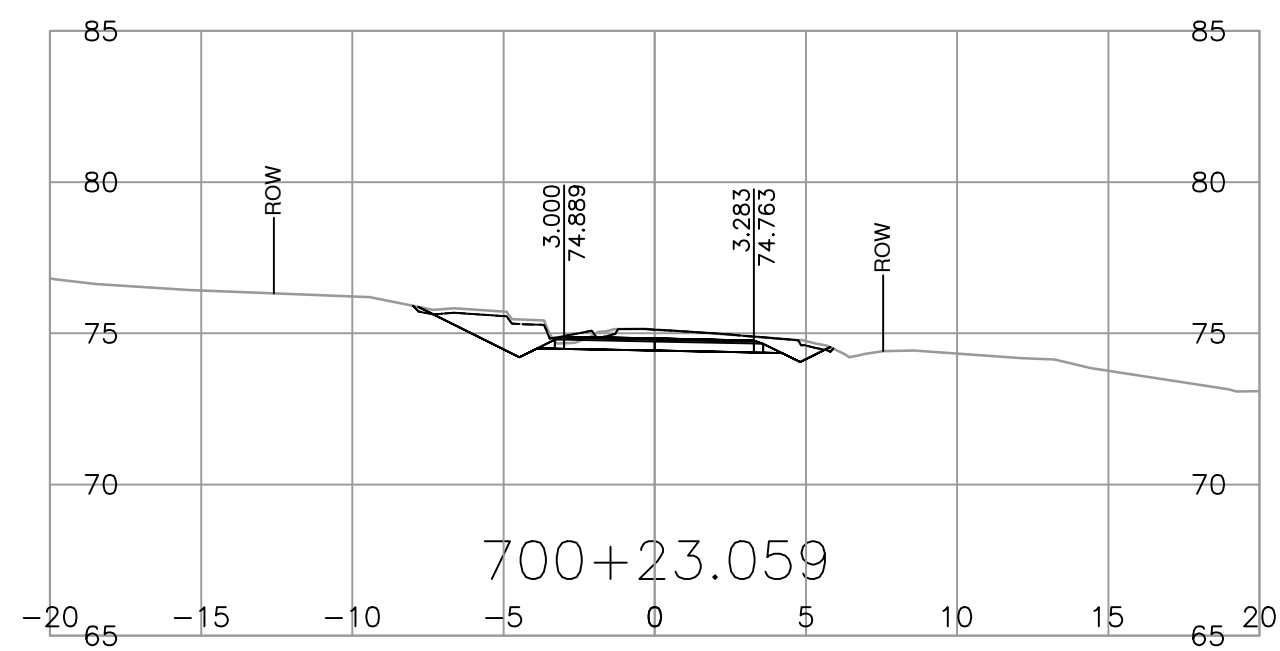
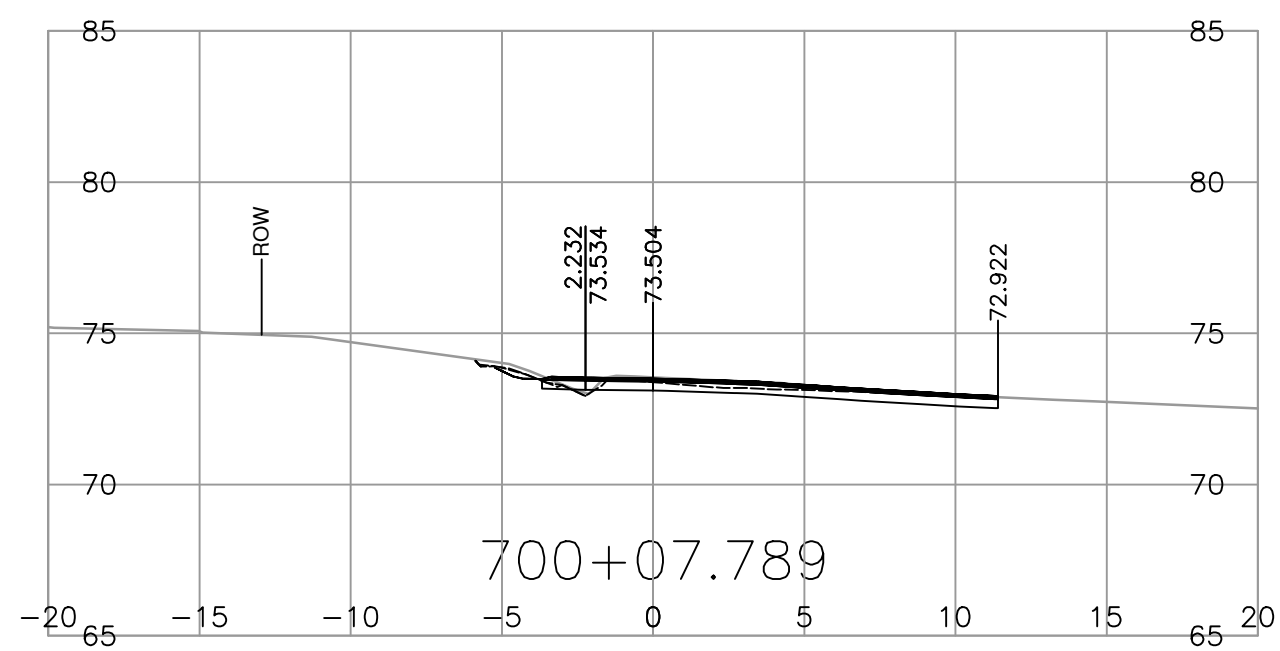
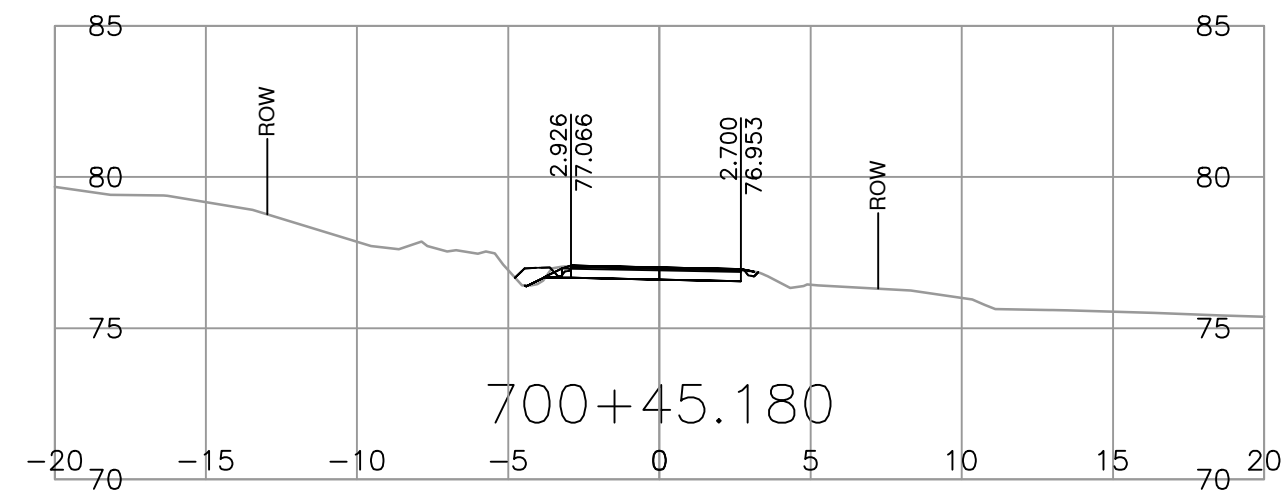
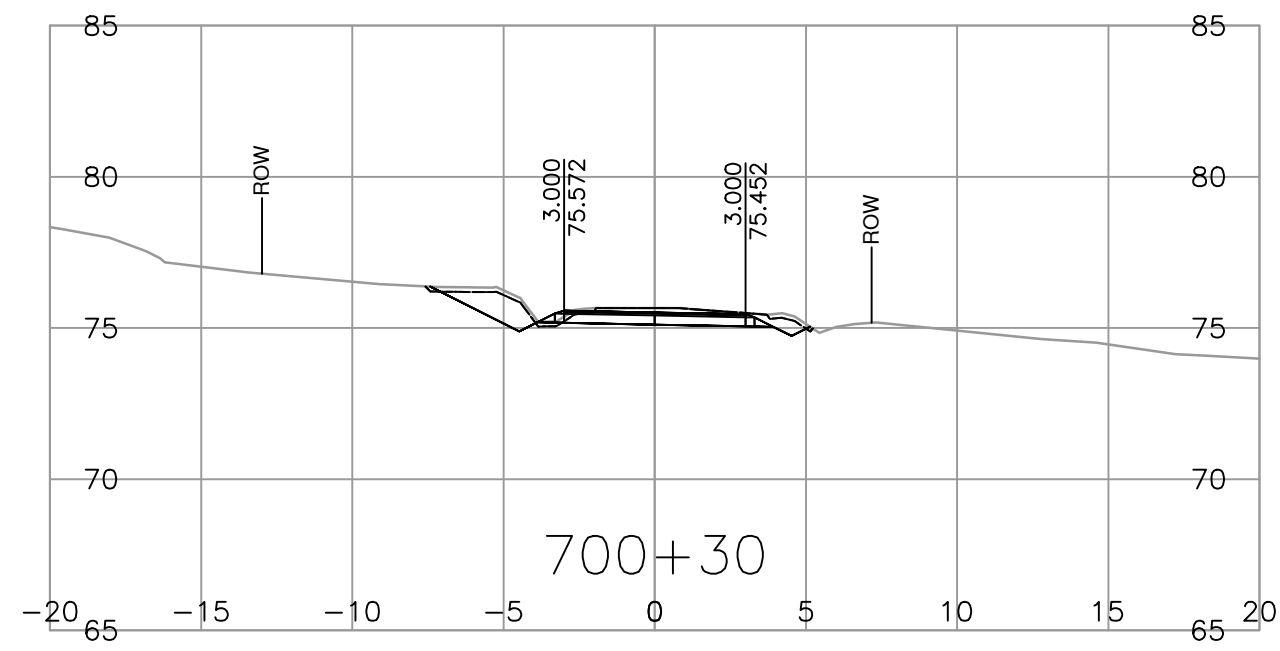
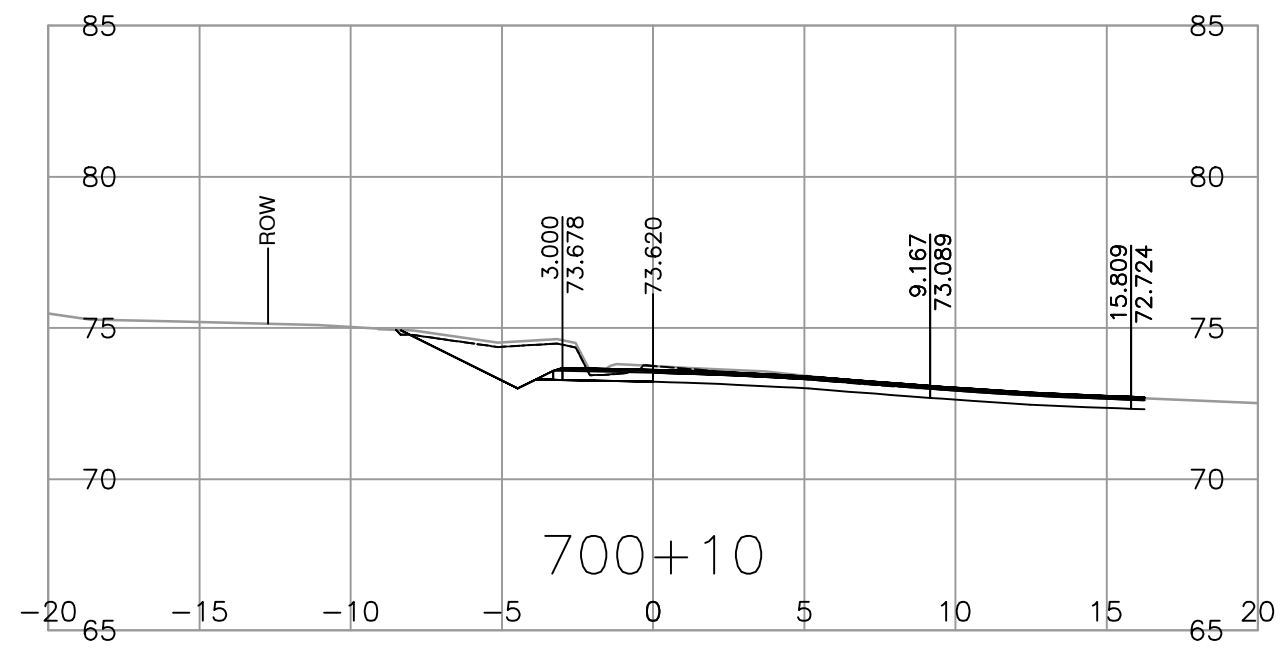
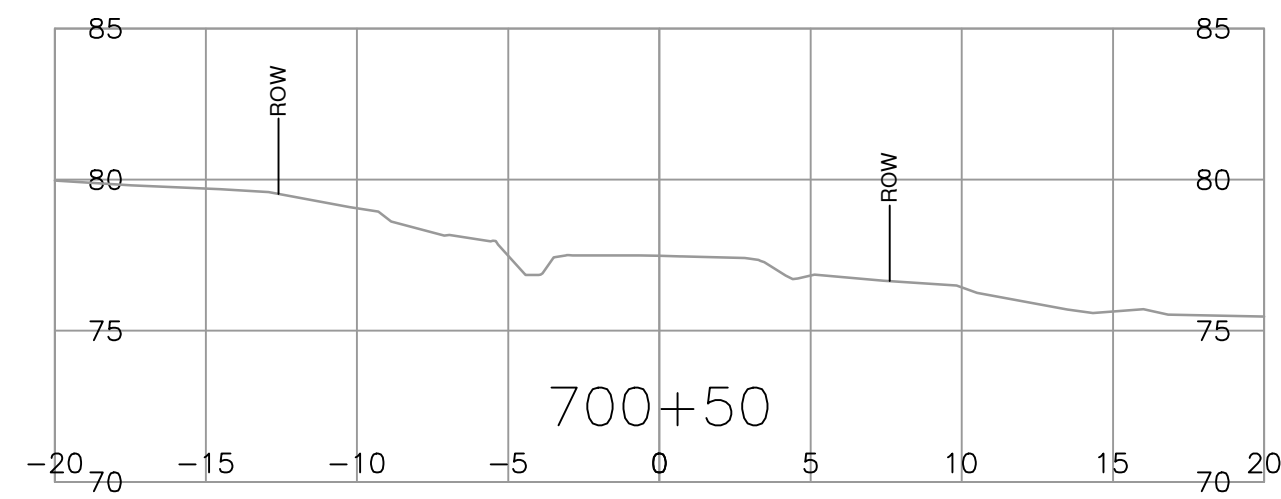
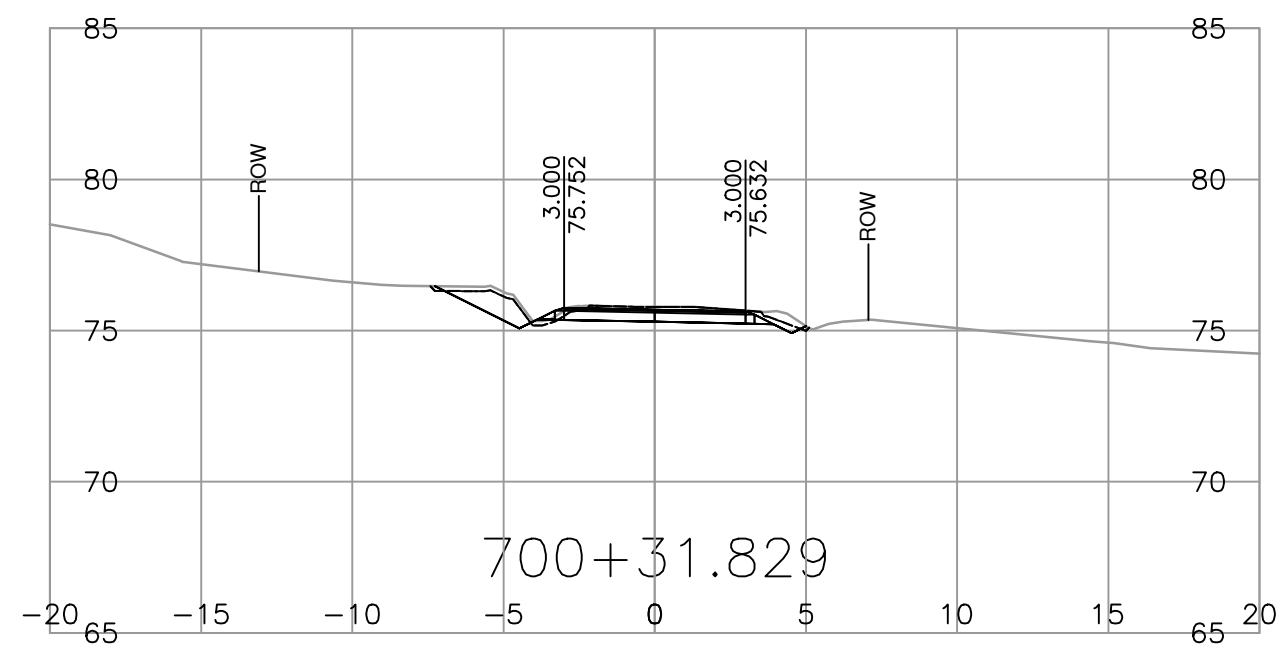
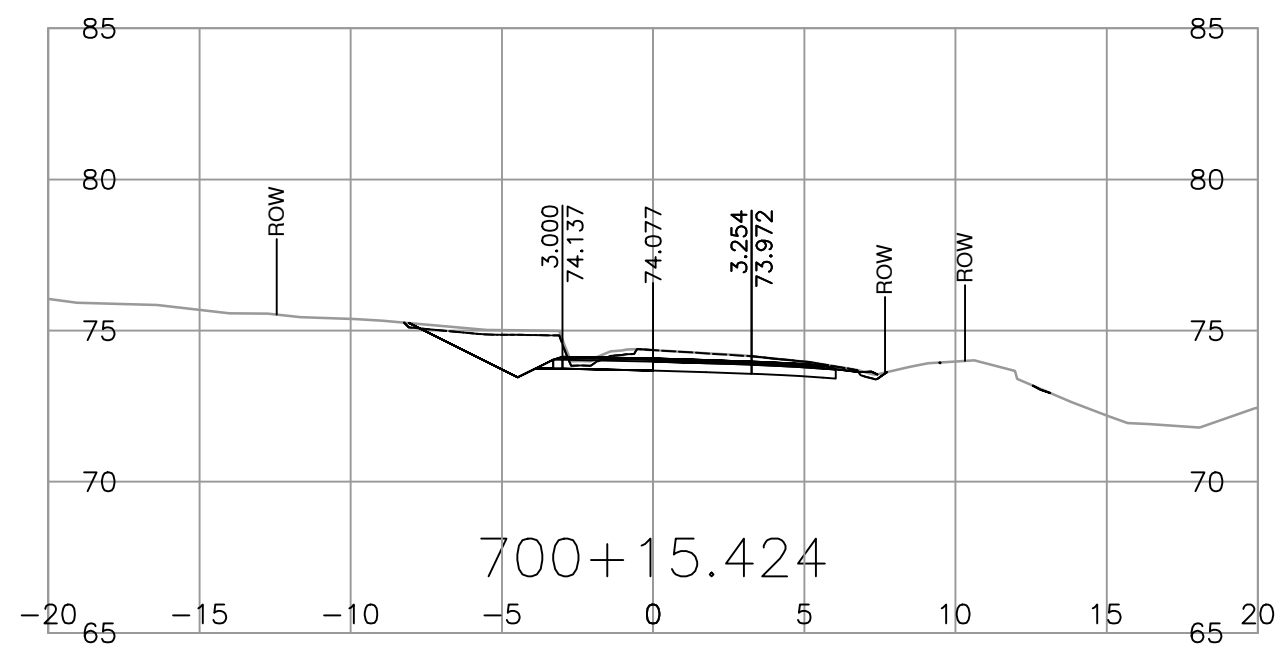
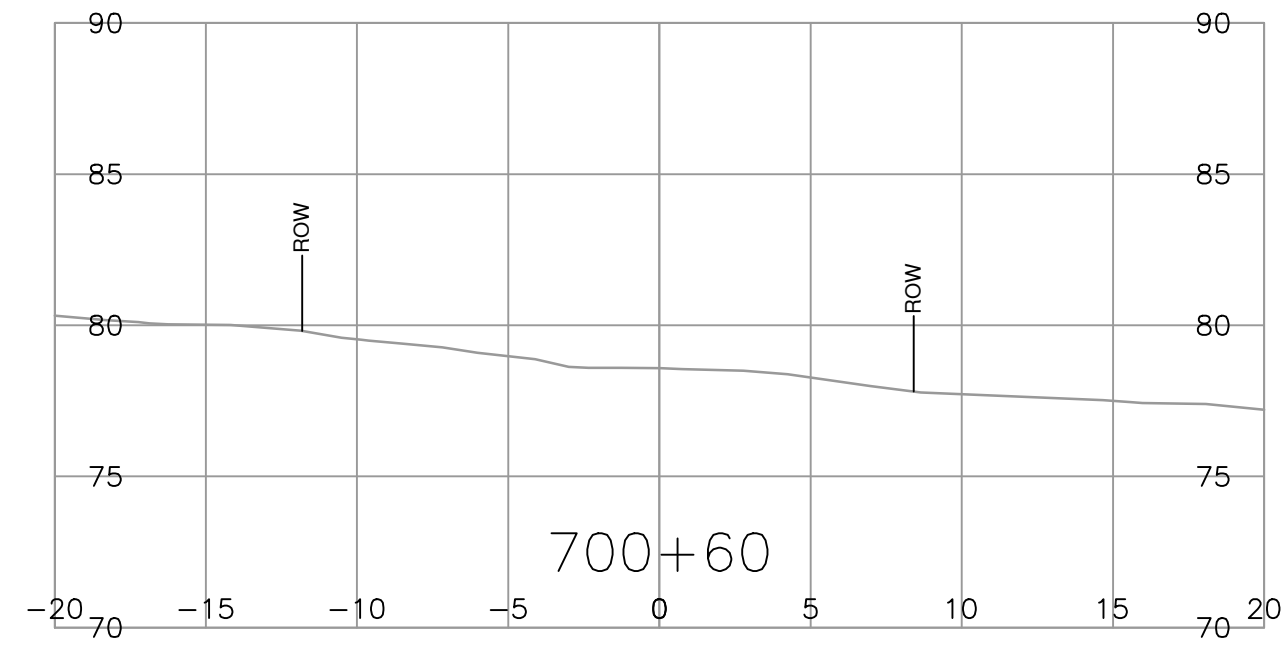
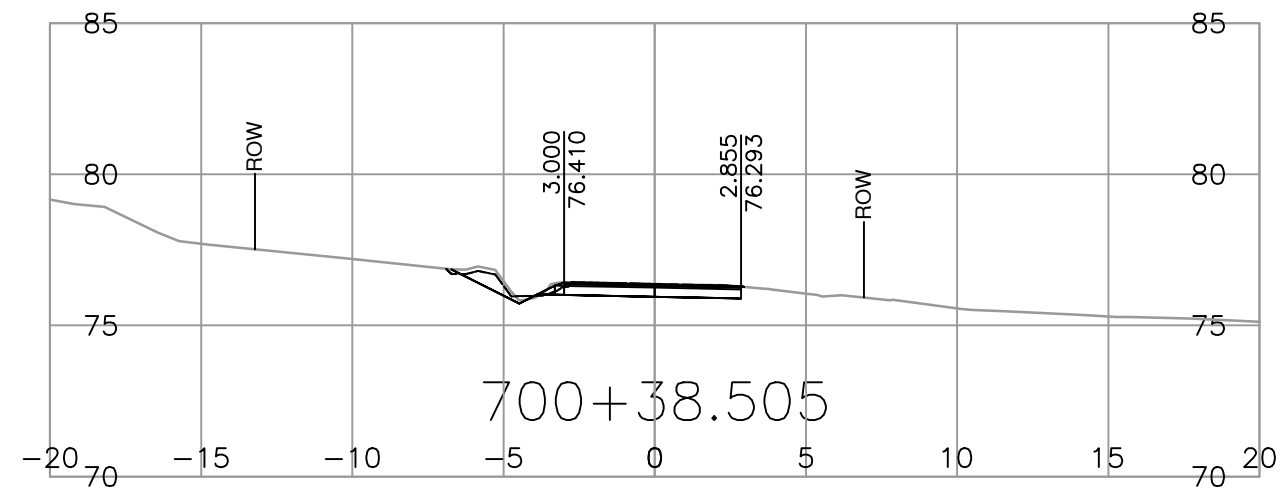
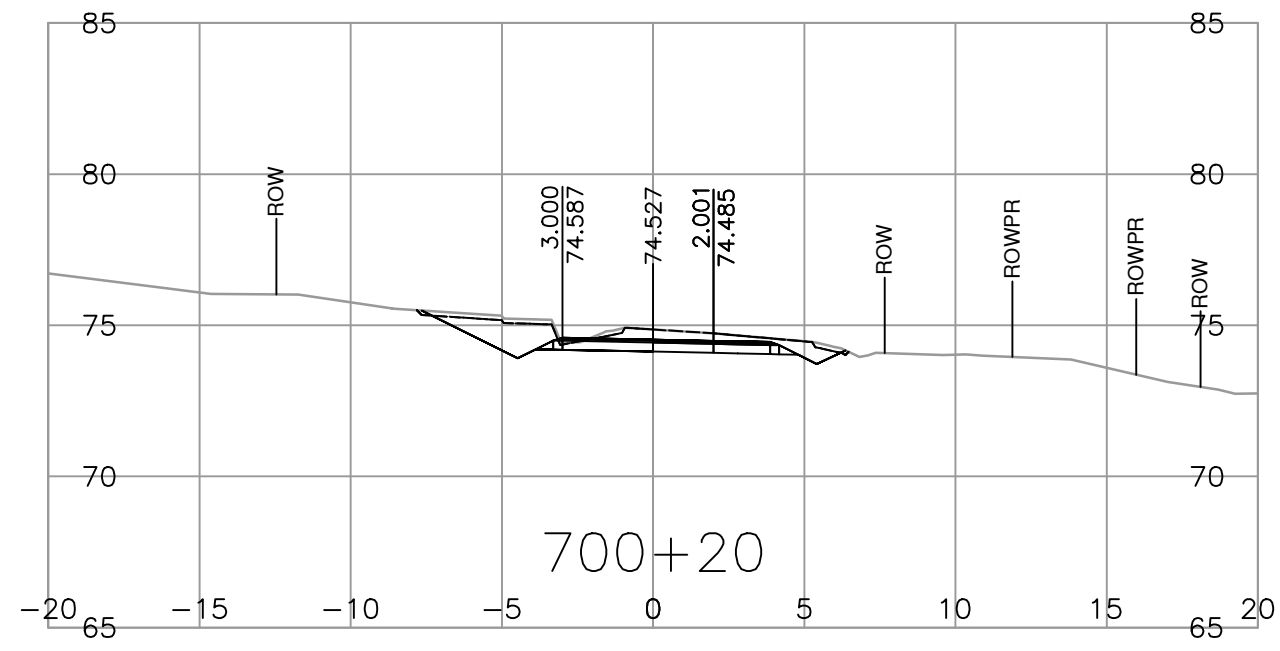

<p>SUITE 201, 8506 - 200 STREET LANGLEY, BRITISH COLUMBIA, V2Y 0M1 PH : 604.371.0091 FAX : 604.371.0098</p>	<p>SCALE 0 2 1:250 12m</p>	<p>CAD FILENAME R1-989-1000 PLOT DATE 2024-03-01</p>	<p>MINISTRY OF TRANSPORTATION AND INFRASTRUCTURE SOUTH COAST REGION VANCOUVER ISLAND DISTRICT</p>	<p>TEMPLATE CROSS SECTIONS FULFORD-GANGES ROAD IMPROVEMENT SEAVIEW AVENUE TO CRANBERRY ROAD</p>																
	<table border="1"> <thead> <tr> <th>REV</th> <th>DATE</th> <th>REVISIONS</th> <th>NAME</th> </tr> </thead> <tbody> <tr><td> </td><td> </td><td> </td><td> </td></tr> <tr><td> </td><td> </td><td> </td><td> </td></tr> <tr><td> </td><td> </td><td> </td><td> </td></tr> </tbody> </table>	REV	DATE	REVISIONS	NAME													<p>DESIGNED <u>B. PEEBLES</u> DATE 2024-02-01 QUALITY CONTROL <u>Z. PENDON</u> DATE 2024-02-01 QUALITY ASSURANCE <u>A. SANTOS</u> DATE 2024-02-01 DRAWN <u>J. SHIM</u> DATE 2024-02-01</p>	<p>L700</p>	<p>FILE NUMBER 32836 PROJECT NUMBER 16873-0001 REG 1 DRAWING NUMBER R1-989-1014</p>
REV	DATE	REVISIONS	NAME																	

PLOT DATE: 2024/03/01 G:\Projects\32000\32836_MoTI_Fulford_Ganges_Road_Widening\02_CADD\DrawingProduction\1000_DesignSections\R1-989-1000.dwg

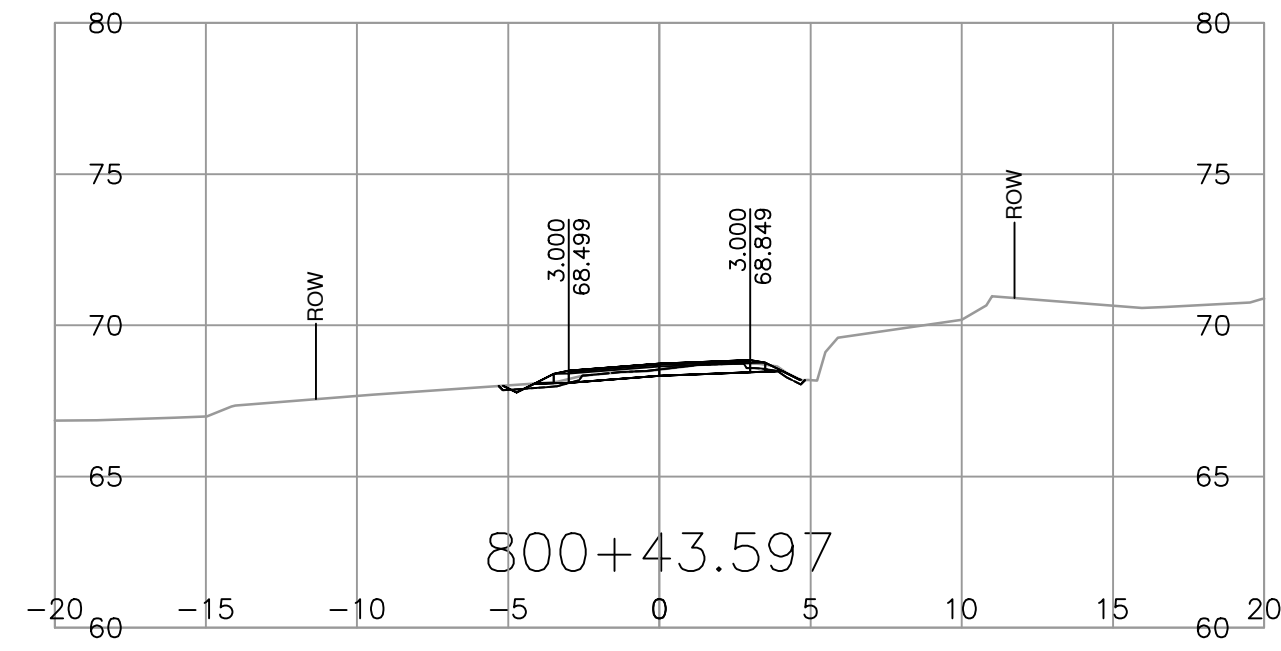
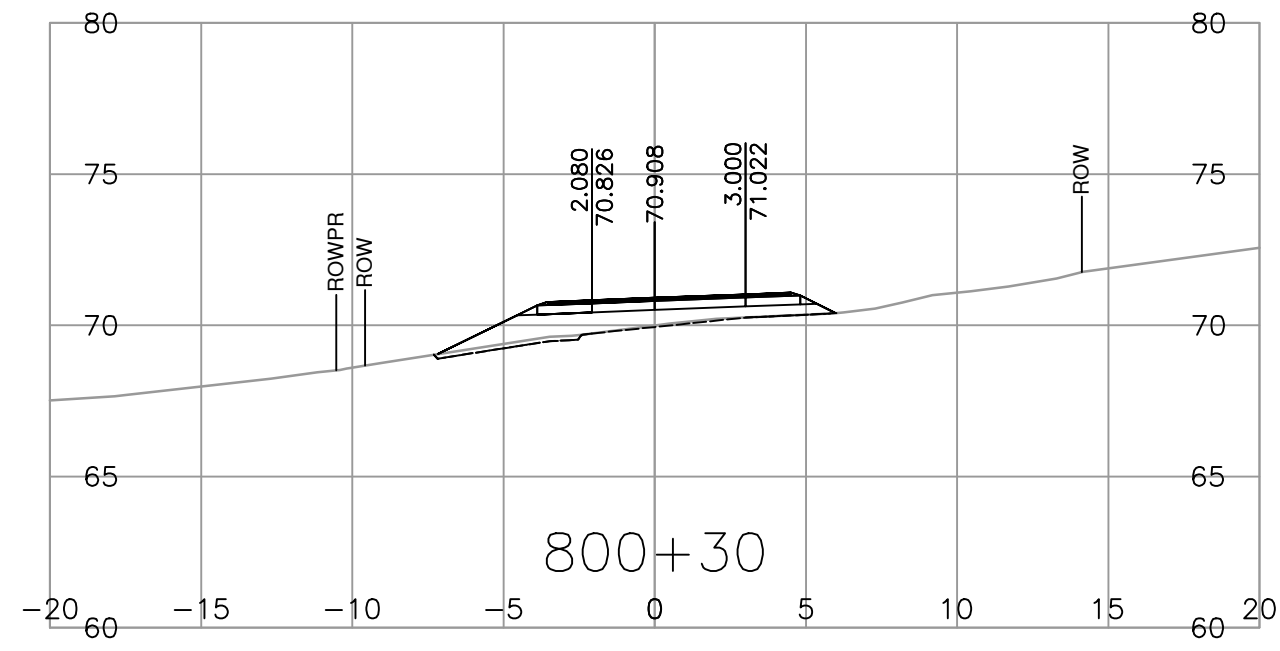
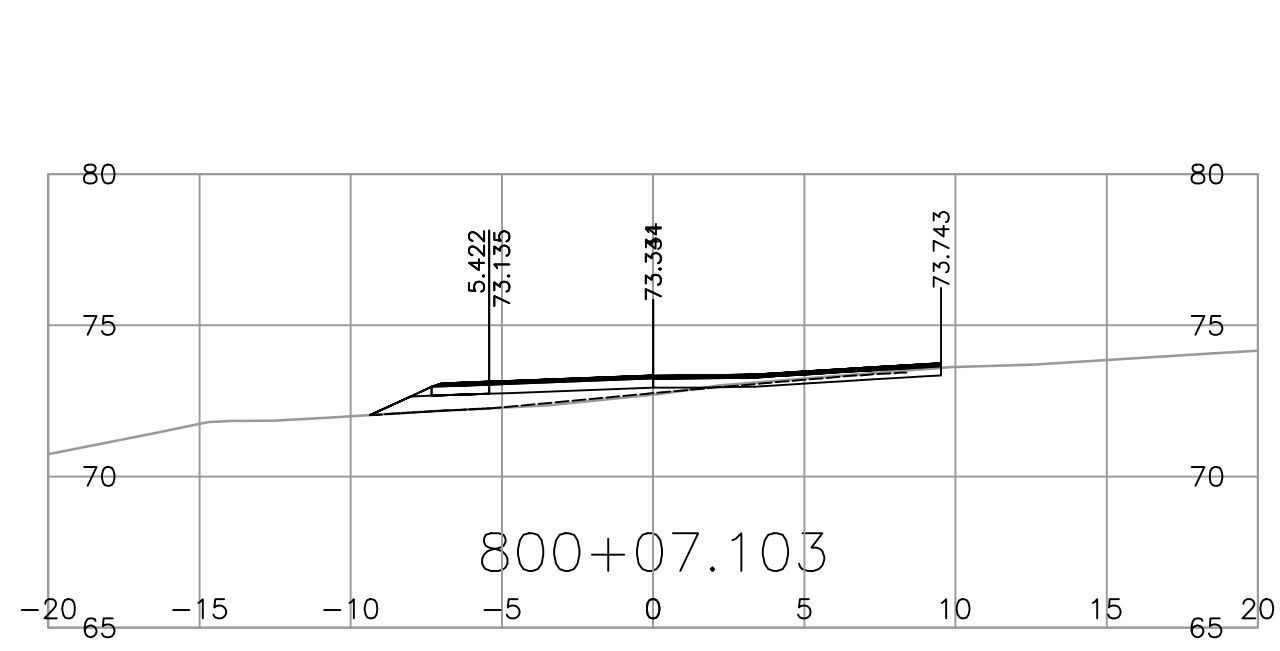
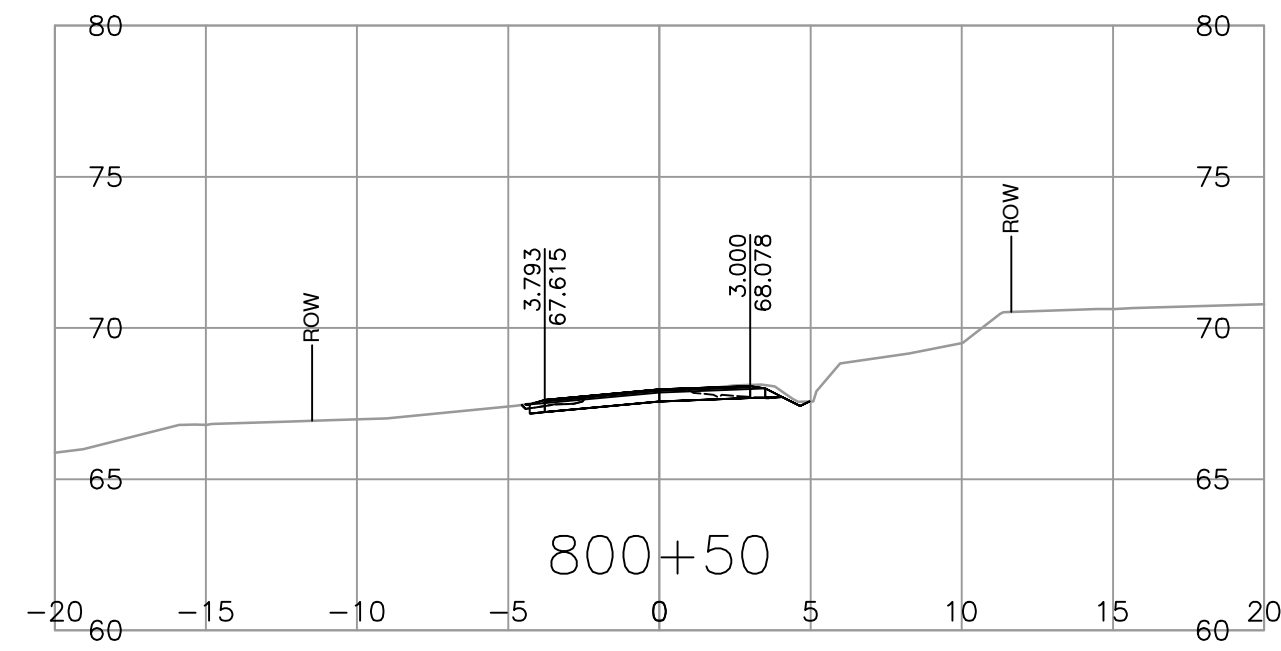
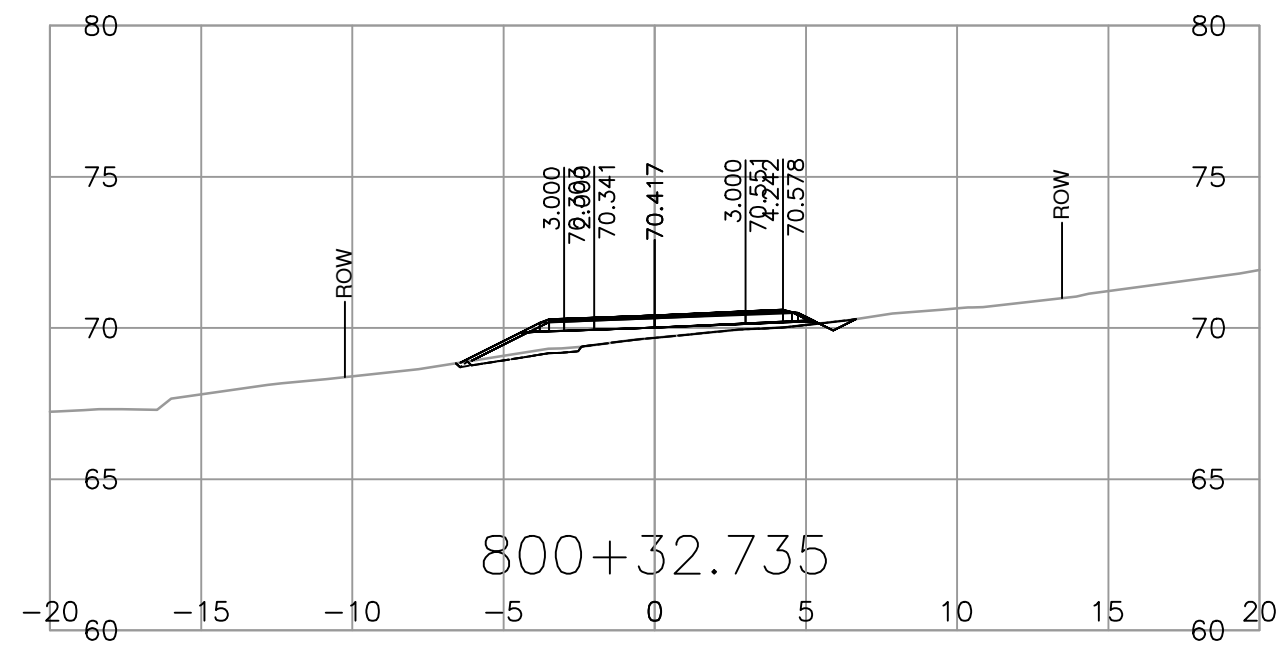
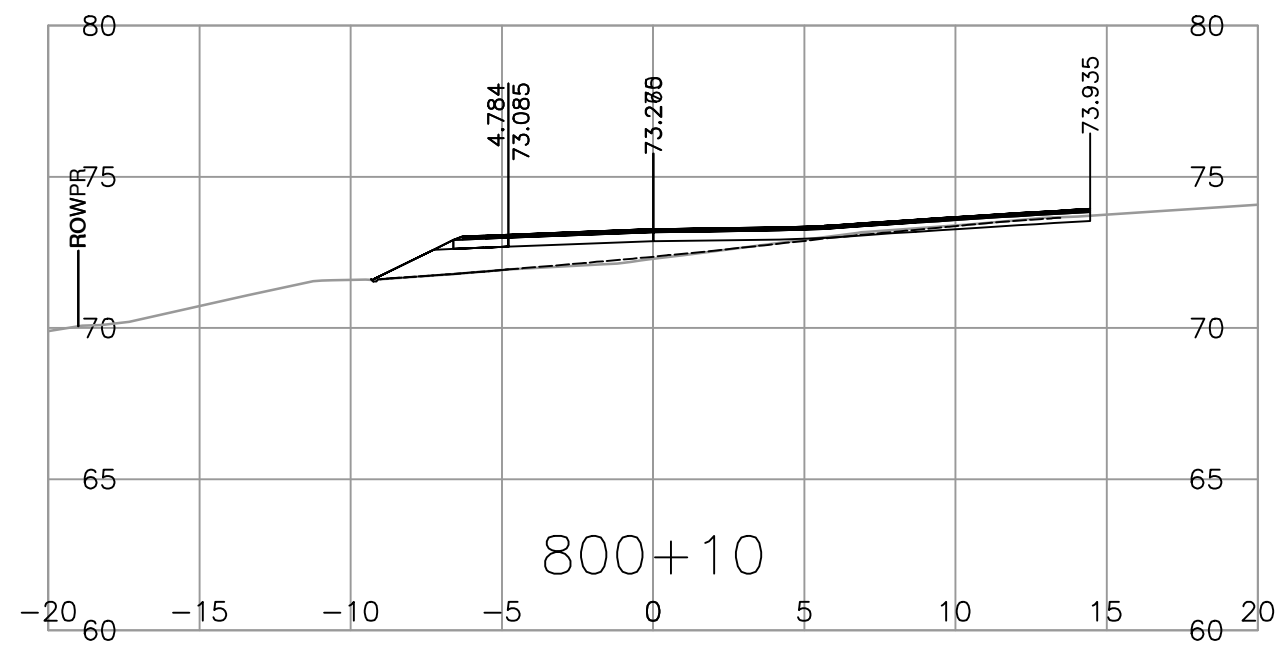
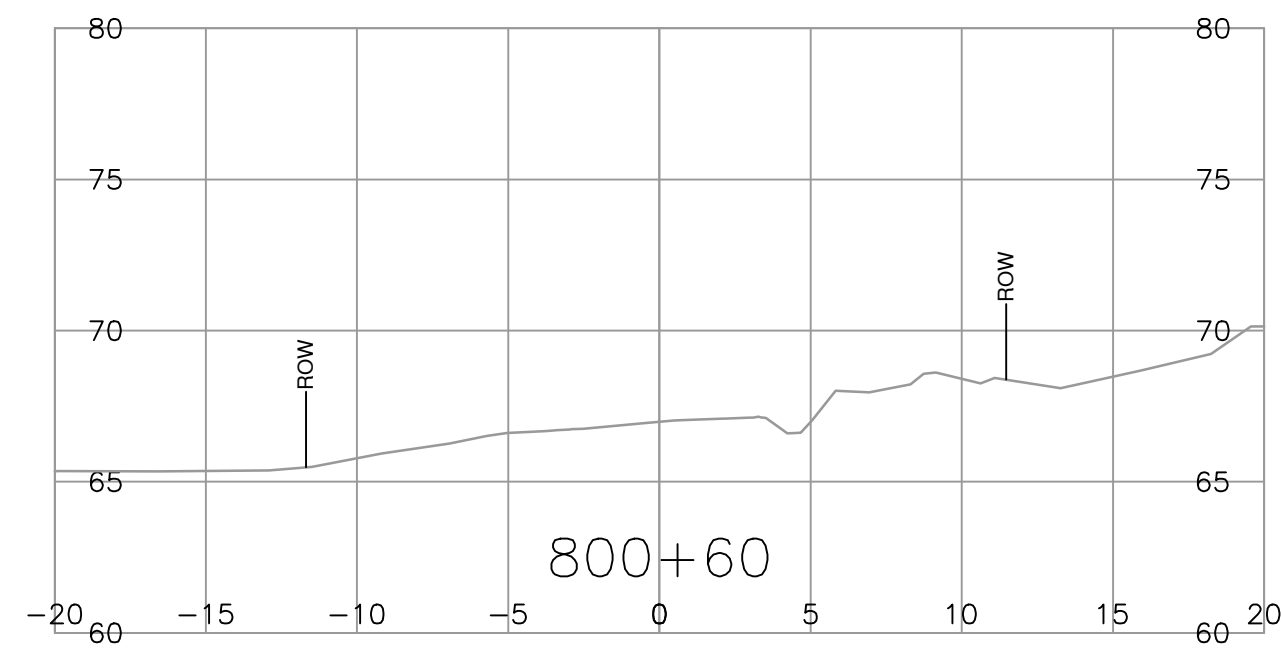
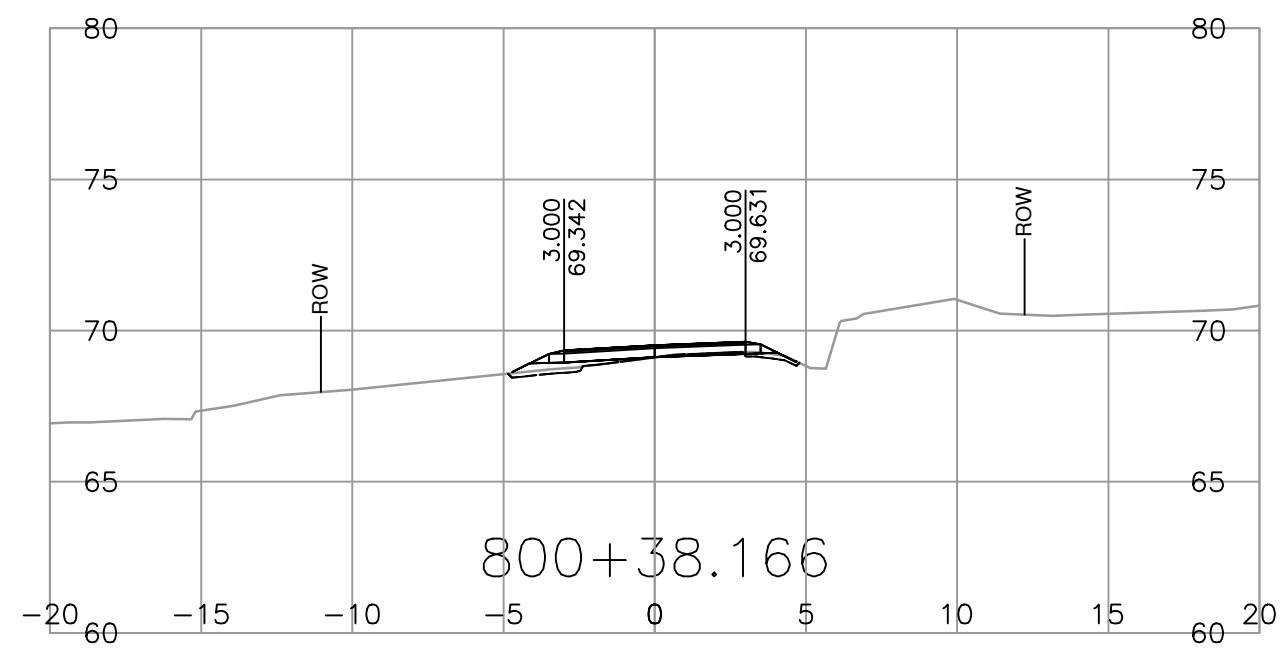
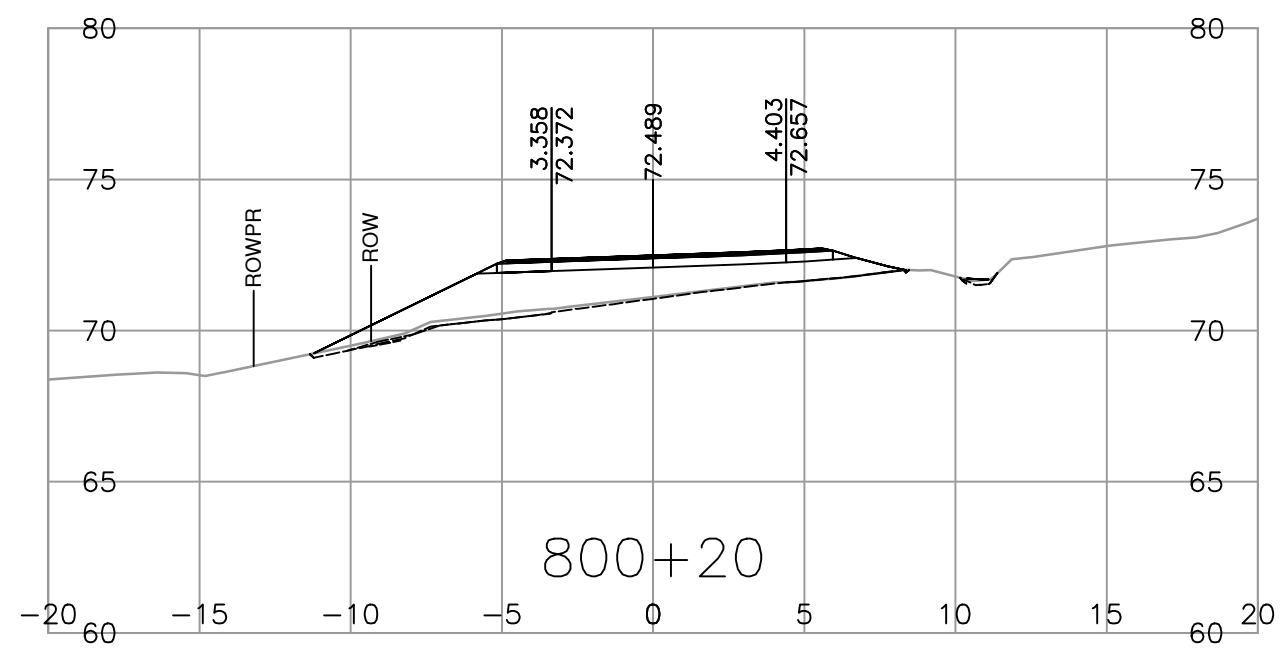
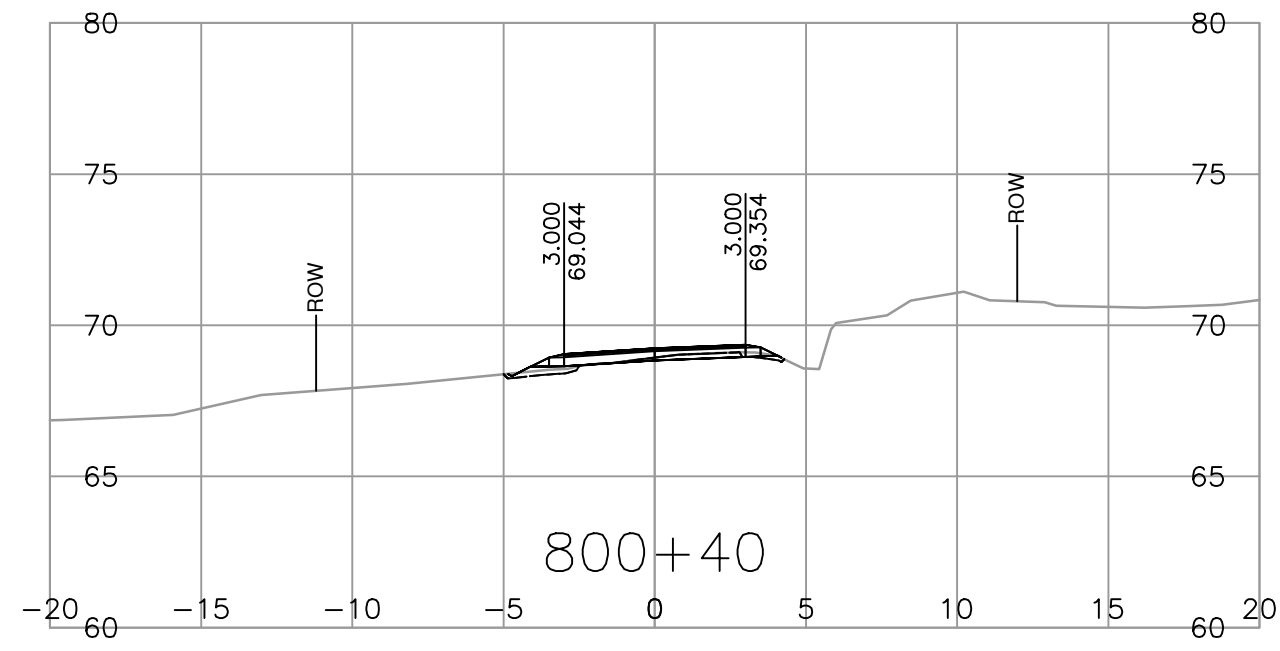
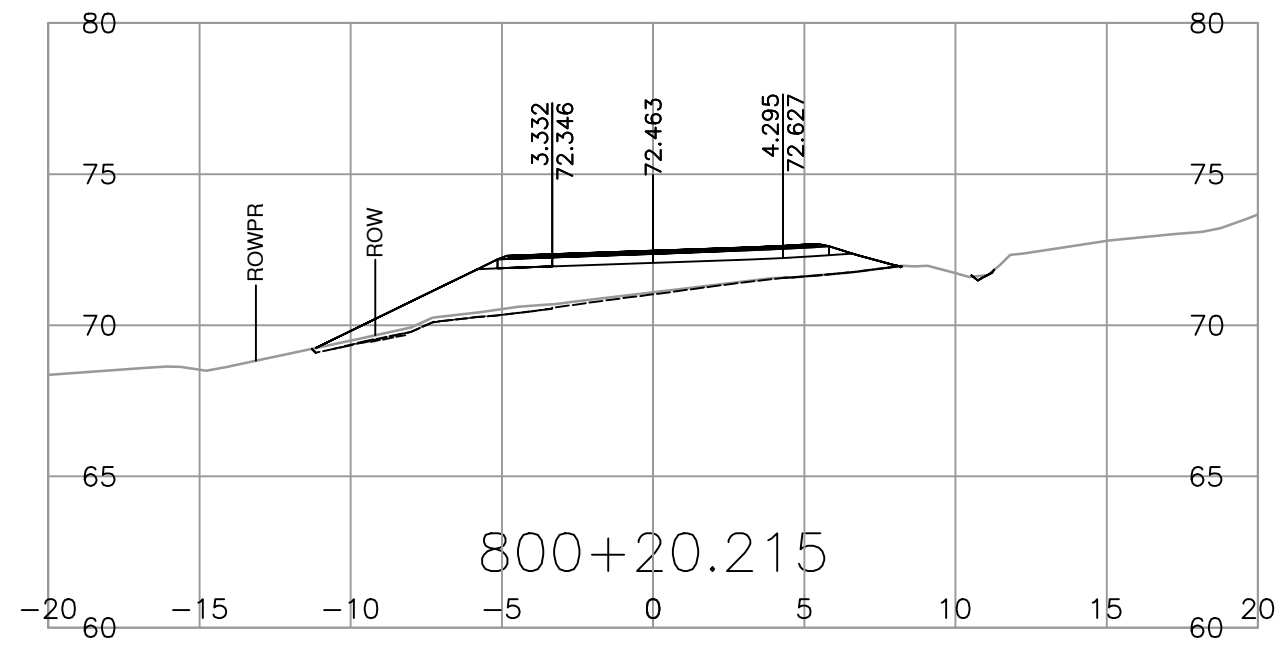

<p>SUITE 201, 8506 - 200 STREET LANGLEY, BRITISH COLUMBIA, V2Y 0M1 PH : 604.371.0091 FAX : 604.371.0098</p>	<p>SCALE 0 2 1:250 12m</p>	<p>CAD FILENAME R1-989-1000 PLOT DATE 2024-03-01</p>	<p>MINISTRY OF TRANSPORTATION AND INFRASTRUCTURE SOUTH COAST REGION VANCOUVER ISLAND DISTRICT</p>	<p>TEMPLATE CROSS SECTIONS FULFORD-GANGES ROAD IMPROVEMENT SEAVIEW AVENUE TO CRANBERRY ROAD</p>																	
	<table border="1"> <thead> <tr> <th>REV</th> <th>DATE</th> <th>REVISIONS</th> <th>NAME</th> </tr> </thead> <tbody> <tr><td> </td><td> </td><td> </td><td> </td></tr> <tr><td> </td><td> </td><td> </td><td> </td></tr> <tr><td> </td><td> </td><td> </td><td> </td></tr> </tbody> </table>	REV	DATE	REVISIONS	NAME													<p>DESIGNED <u>B. PEEBLES</u> DATE 2024-02-01 QUALITY CONTROL <u>Z. PENDON</u> DATE 2024-02-01 QUALITY ASSURANCE <u>A. SANTOS</u> DATE 2024-02-01 DRAWN <u>J. SHIM</u> DATE 2024-02-01</p>	<p>FILE NUMBER 32836</p>	<p>PROJECT NUMBER 16873-0001</p>	<p>REG 1</p>
REV	DATE	REVISIONS	NAME																		