

To: Dickson Chung
British Columbia Ministry of
Transportation

From: Catalina Tandara
Stantec

Project/File: Chilliwack Lake Road Flood Recovery (1158200850) Date: April 5, 2023

Reference: 14095-0002 Chilliwack Lake Road – Site D Box Culvert at Anderson Creek

1 Introduction

This technical memo provides Stantec’s design basis and recommendation for the flood damage repairs for the 14095-0002 Chilliwack Lake Road Flood Recovery – Site D Box Culvert. The Box Culvert site is located along the Chilliwack Lake Road 14.4 km East of Vedder Road roundabout bridge at the apex of the alluvial fan of Anderson Creek.

As stated in technical memorandum “14096 Chilliwack Lake Road Box Culvert”, February 4, 2022, the 2.0m by 2.0 m cast-in-place concrete Box Culvert installed underneath Chilliwack Lake Road conveys high flows from Anderson Creek to the Chilliwack River. Located upstream of the culvert is an artificially raised boulder riffle that diverts low flows eastward down the diversion channel to the spawning ponds shown in Figure 1.



Figure 1. Plan View of Box Culvert Site

Reference: 14096

The boulder riffle, diversion channel and the spawning ponds are maintained by Fisheries and Oceans Canada (DFO).

In November 2021, the southwest portion of the Province experienced heavy rainfall that lead to larger flow events, debris-floods and debris-flows on watercourses in the area. During larger flow events, alluvial fans undergo large amounts of deposition with larger sized debris being deposited at the apex. While no records of the response at Anderson Creek was made available to Stantec, our review of the site post-flood suggests that wood and potentially large rock debris deposited at and above the culvert inlet, reducing its capacity and redirecting the majority of the flow down the diversion channel towards the spawning ponds. Deposition at the site aided in the breach of the diversion channel banks resulting in damage to the road infrastructure, presumably caused by lateral erosion. Continuous deposition of smaller debris and sediment occurs at the site due to its location at the apex of the fan. DFO notified Stantec during a meeting on June 13, 2022 that dredging of the diversion channel and maintenance of the boulder riffle is performed yearly.

Figure 2 is of an image taken during Stantec's site visit in January 2022. Photo is taken prior to the clearing of the deposited rock material and repair to the asphalt surface of Chilliwack Lake Road.



Figure 2. Box Culvert Site after the November 2021 Heavy Precipitation Event

Reference: 14096

It is our understanding that the maintenance contractor re-established Anderson Creek and DFO re-established the diversion channel and the artificially raised boulder riffle to pre-flood conditions. In addition, an overflow gravel berm was installed above the diversion channel's left bank to reduce the flow length of future high flow events along the road embankment, it is unclear at this time if the gravel berm was constructed by the maintenance contractor or DFO. Site D in its re-established condition still poses a risk to Chilliwack Lake Road from breached larger flow events. Stantec recommends installing an armoured guide bank between the road and the diversion channel to mitigate erosion risk of the road embankment.

2 Hydrology

Anderson Creek's watershed has a generally steep forested terrain. The largest of peak flows are mostly experienced during the fall months when rain-on-snow events are more likely.

The design return period for the site was selected in accordance with BC MoTI (2007) Table 1010. Which stipulates that the design return period for channel control works on roads classified local to freeway shall use a 1 in 200-year design flow. Historical and climate change predications for total precipitation values and rainfall intensity rates from 1 in 2-year to 1 in 100-year were attained using IDF_CC Tool 6.0 ungauged interpolated IDF for Lat: 49.07663°, Lon: -121.78432° with PCIC Climate Model Scenario RCP 8.5 predictions. The 1 in 200-year rainfall intensity was extrapolated from that data. The use of PCIC Climate Model Scenario RCP 8.5 is described in Appendix A – Climate Change Criteria Sheet.

As prescribed in BC MoTI TAC Supplement for Geometric Design (TAC) for rural watersheds up to 10 km², the Rational Method may be suitable in calculating design flow. Proceeding with the Rational Method the following parameters were used:

Rainfall Intensity Rate - 21.5mm/hr

Runoff Coefficient: 1.05 – mostly forest, large return period and snowmelt

Time of Concentration: 1.8 hrs – Average of Water Management Method and SCS Lag Equation

Intensity Duration: 2 hrs

Watershed Area: 5.57 km²

Watershed Length: 5.42 km

In using the Rational Method the 1 in 200-year design flow of 34.96 m³/s was selected.

3 Hydrotechnical Analysis

1-D Model Set-up

Topographic survey was captured on March 10, 2022 by Binnie Survey. A portion of Chilliwack Lake Road, Anderson Creek, diversion channel and the inlet of the Box Culvert were captured within the extents of this survey. The survey was processed into a digital elevation model (DEM) and provided to Stantec.

To estimate the water surface elevations, a hydraulic analysis was completed for the design flow assuming full blockage of Anderson Creek at the Box Culvert using a one-dimensional (1D) hydraulic model built upon the US Army Corps of Engineers HEC-RAS (Version 6.1) platform.

The 53 m long hydraulic model consists of six cross sections with channel geometry attained from the provided DEM. Two cross sections are located perpendicular to Anderson Creek with the remainder of cross sections located along the diversion channel. Locations of the cross sections are shown in Figure 3.

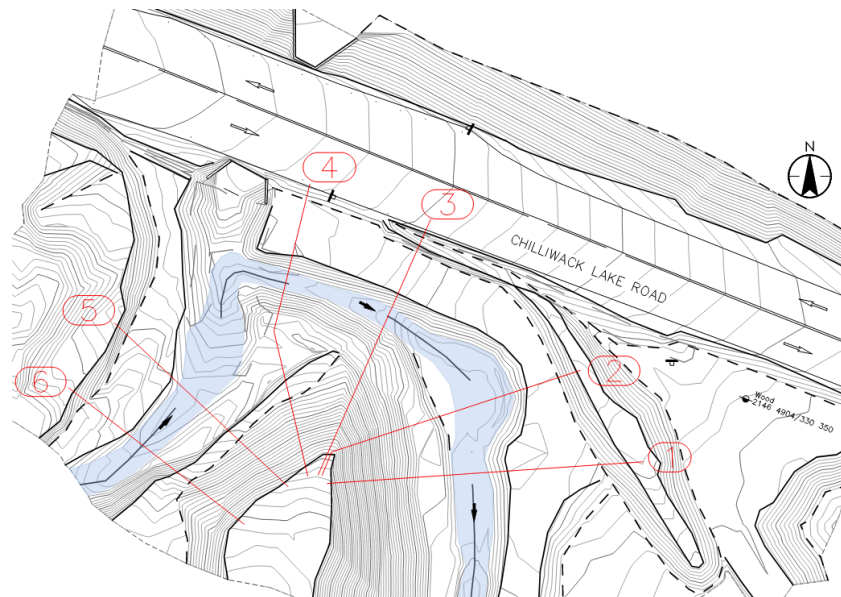

Figure 3. Locations of Cross Section for Hydraulic Modelling

Stantec used the following key model input parameters:

- The upstream and downstream boundary was assumed to be normal depth of 0.08338 m/m. This slope was measured from the DEM along the thalweg of the model length and iterated to match the energy grade slope.
- As observed from the site photos, little vegetation remains in the overbanks post-November 2021. The channel and banks mostly composing of fines and cobbles were given a manning's roughness value of 0.035 (Chow 1959).

Reference: 14096

As parameter for the design of the guide bank, the model was set up under the assumption that the Box Culvert becomes blocked, and all flow is diverted eastwards towards the spawning ponds. Two model geometries were run under the 1 in 200-year design flow, one of the re-established conditions and the second with the proposed guide bank.

1-D Model Results

The purpose of the hydraulic model was to estimate water surface elevations and velocity during the design flow event. The resulting water surface elevations for hydraulic sections 4 and 3, sections perpendicular to Chilliwack Lake Road under re-established conditions, are shown in Figure 4 and Figure 5, respectively.

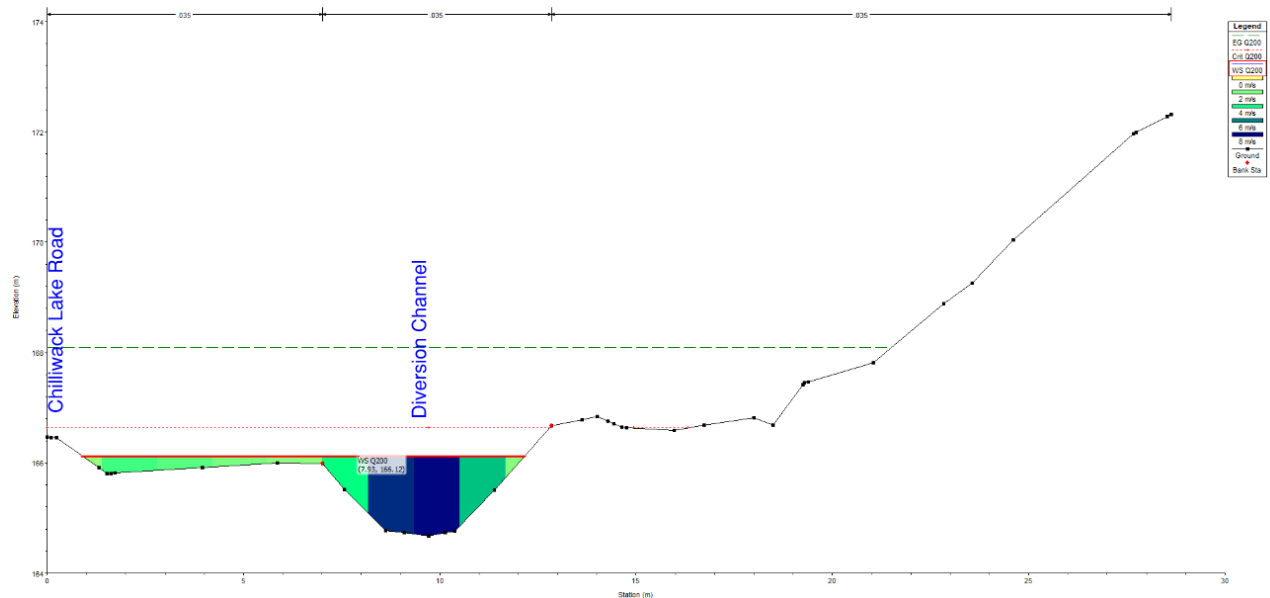

Figure 4. 1-D Model Hydraulic Section 4 - Design Flood Event – Existing Conditions

Reference: 14096

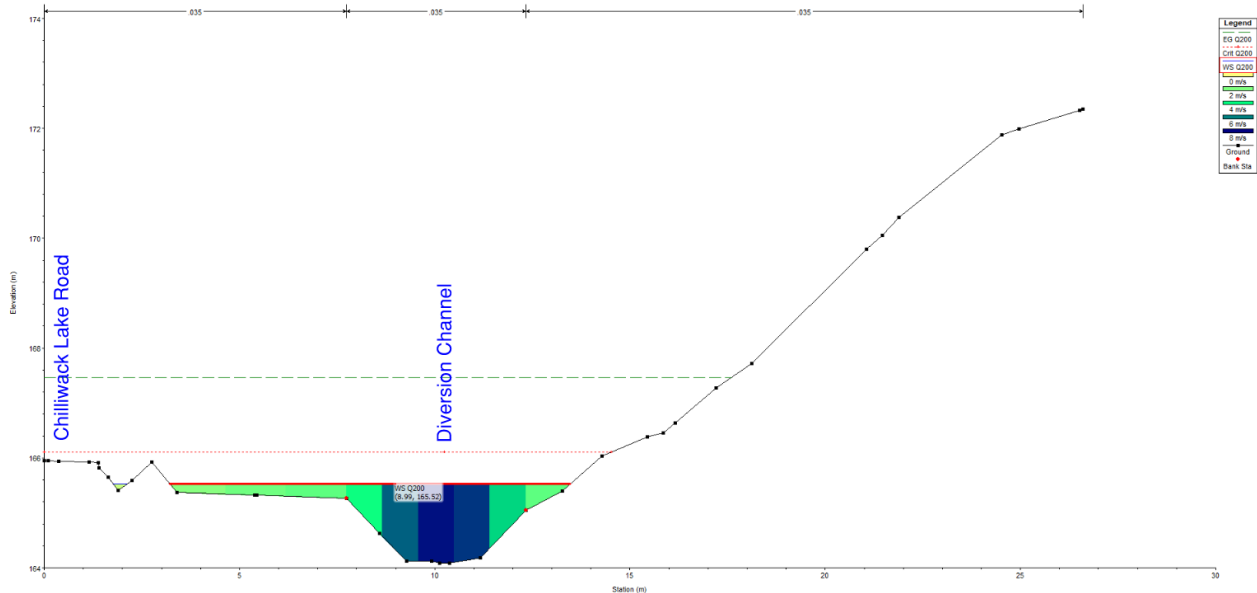

Figure 5. 1-D Model Hydraulic Section 3 - Design Flood Event – Existing Conditions

As shown in Figure 4 and 5, under re-established conditions Chilliwack Lake Road is not overtopped but the presence of water flow against the road embankment presents a risk of erosion. The modelled velocities along the road embankment exceed those that cobbles and pebbles can withstand according to TAC 2019 Table 4.3.

Due to the presence of fast flowing water at the toe of the road embankment, Stantec recommends the placement of a guide bank between the road embankment and the diversion channel.

A second hydraulic model was run under the same 1 in 200-year design flow to determine the effects of a guide bank to the water surface elevations and velocities. This guide bank was portrayed as a levee point in the channel geometry of hydraulic sections 3 and 4. The effects of the guidebank to the water surface elevations and velocities are shown in the following Figure 6 and Figure 7.

Reference: 14096

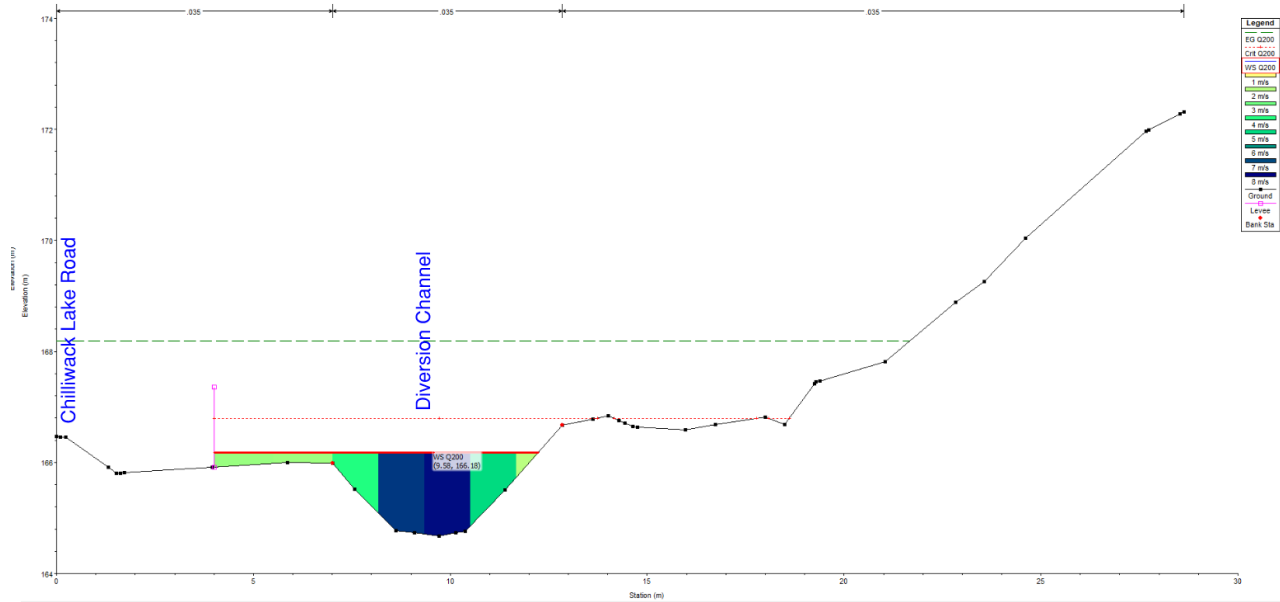

Figure 6. 1-D Model Hydraulic Section 4 - Design Flood Event – Proposed Conditions

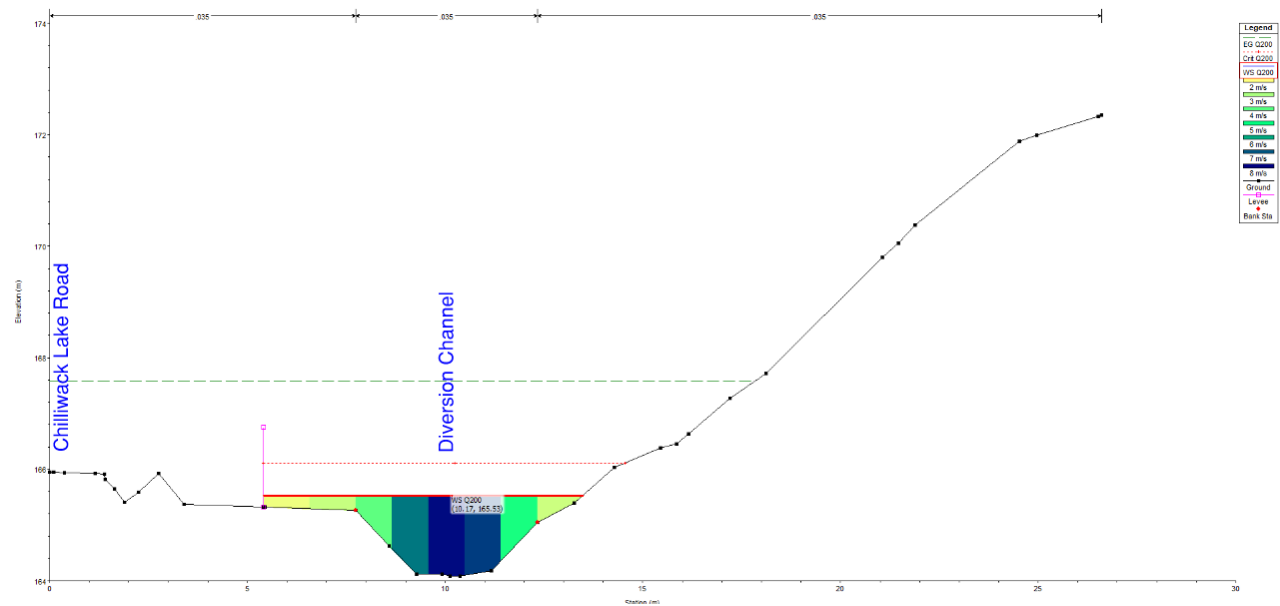

Figure 7. 1-D Model Hydraulic Section 3 - Design Flood Event – Proposed Conditions

Design with community in mind

Reference: 14096

The addition of the levee increased water surface elevations 0.06 m and 0.01 m at hydraulic section 4 and 3, respectively. The design of the recommended guidebank proceeded using the water surface elevations from the second model.

Assumptions:

- *Assumed full blockage of the Box Culvert and all of the design flow conveyed through the diversion channel towards the spawning ponds*
- *No calibration of the model was completed as there were no observable high water marks and flow rates recorded on Anderson Creek from the November 2021 Event.*
- *Did not model for debris flow or debris flood as attaining data to complete this model was outside the scope of this study.*

4 Design

Road Design

Breaching of the November 2021 water levels at the site and the diversion of water along its side to the spawning ponds caused damage to the road embankment and road base from erosion and washed away portions of pavement in the eastbound lane. Image 1.1 below shows the extent of the damage. The damage has been repaired by the Maintenance Contractor and is therefore no longer included in this scope of work.

Reference: 14096



Image 1.1 Asphalt Damage post November 2021 event. Repaired by the Maintenance Contractor.

The November 2021 high water levels also caused damage to the opposing barrier flare parallel to the eastward bound travelled road lane. The initial repair of the site did not reinstate the asphalt apron for the barrier flare. The barrier was placed in a straight line, contrary to pre-event condition and BC MoTI standard. Image 1.2 below shows the temporary reinstalled barrier.

Reference: 14096



Image 1.2 Temporary Re-Installed Barrie. Non-Compliant to BC MoTI Standards

For this classification and design speed of roadway, the BC TAC Supplement recommends a paved opposing barrier flare be tapered at 4:1 with a flare offset between edge of lane and back of barrier. The length of taper is dictated by the offset and the taper ratio. Figure 8. Below shows a typical barrier flare layout arrangement.

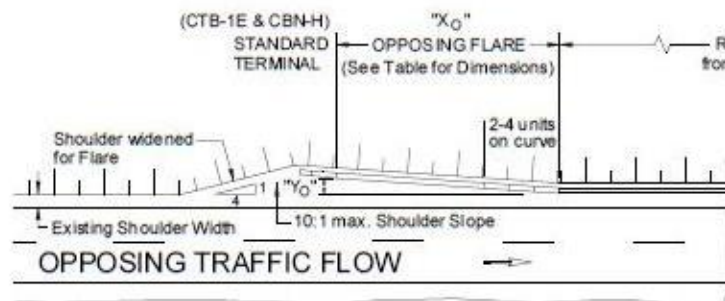

Figure 8. Typical Barrier Flare Layout, Compliant to BC MoTI Standards

Reference: 14096

The work proposed in this memo will include reinstatement of the paved barrier flare and installation of the necessary barrier to meet BC MoTI standards.

The ultimate design should consider clear zone requirements for works being installed beyond the travelled lane. Suggested clear zone width for the posted speed and traffic volumes at the site is 3.5 m. Any works proposed within the clear zone must be assessed as a potential hazard and have mitigative measures prescribed.

The proposed obstruction in parallel with the road will be installed beyond the clear zone. The proposed obstruction that run perpendicular back to the road will be installed behind the barrier which will mitigate potential risk to the travelling public.

Hydraulic Design

The June 13, 2022 meeting with DFO in which Stantec was informed of DFO's yearly dredging of the diversion channel and maintenance of the artificially raised boulder requires regular access. In consideration of that, the proposed hydraulic design needs to provide impediment to potential overland flow while maintaining access for equipment to Anderson Creek for DFO. The design must also consider road safety and the Clearance Zone.

To meet the design parameters, Stantec recommends a linear placement of concrete blocks as the guidebank between the road embankment and the diversion channel. Concrete blocks that extend beyond the road barrier are to be placed along the Clearance Zone. Behind the road barrier the concrete barriers are to be placed 3.0 m away from the top of bank.

The concrete blocks are to be placed in a single file; however concrete blocks at the upstream extent are to be grouped together at the divergence of Anderson Creek and the diversion channel. This grouping provides resistance to the energy momentum produced from the 90 degree change in the flow direction from Anderson Creek to the diversion channel. At the downstream end of the concrete block, the concrete blocks are to be keyed into the existing overflow berm.

Class 50kg Riprap is to be keyed into the existing grade of the riverside of the concrete blocks at the concrete block's toe in an area that is approximately 1.7 m wide and 0.57 m thick. The hydraulic model suggests velocities up to 2.4 m/s along the toe of the concrete blocks. The 50kg Riprap mitigates avulsion risk from the design flow event. Non-woven geotextile will be keyed-in and placed underneath the Class 50kg Riprap.

The concrete block's height of 0.76 m is sufficient in providing an impediment to the design flow event along the entirety of its length. But as stipulated in TAC 2019 a 0.3 m freeboard is to be incorporated above the water surface elevations. In order to achieve the requirements of the freeboard, minor fill of 0.1 m is required below the concrete blocks at the upstream end.

A typical section of the hydraulic design is shown in Figure 9.

Reference: 14096

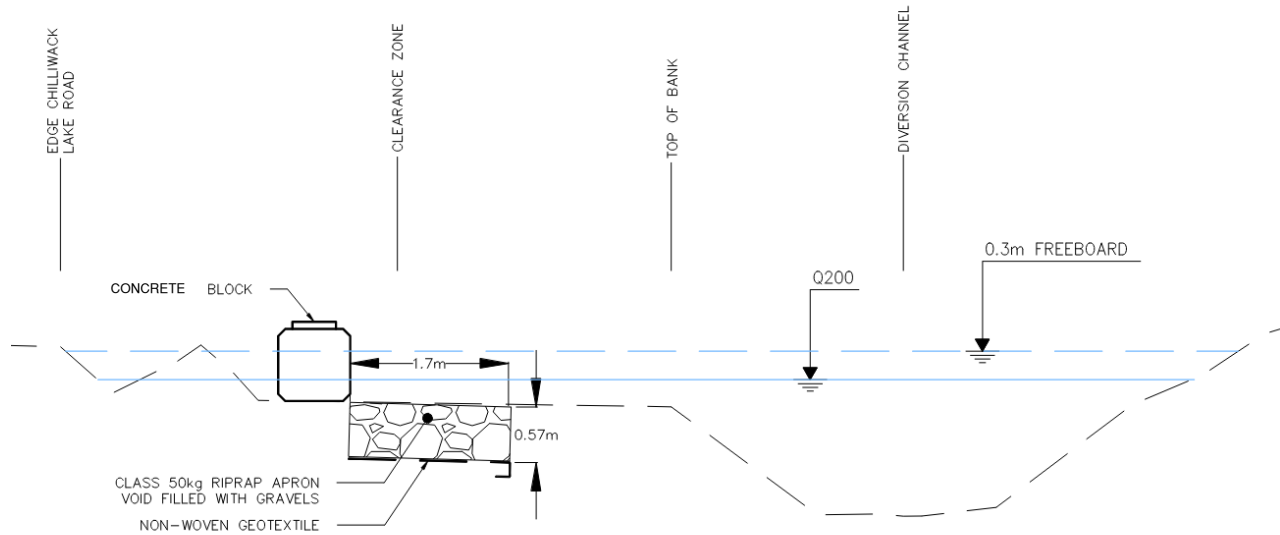

Figure 9. Proposed Cross Section of the Design at the Box Culvert Site

Linear placement of concrete blocks does not provide an impervious barrier. Some water from the design flow event is expected to seep through the spaces of the concrete blocks and inundate the area between the road embankment and the concrete blocks. While these concrete blocks do not serve as a waterproof barrier they will considerably reduce the amount of overland flow along the road embankment; thus, significantly reducing the risk of damage to the road infrastructure or impediment to traffic flow. The concrete blocks can be moved by equipment should DFO need to access Anderson Creek and the diversion channel. Deposition from large flow events may shift the concrete blocks into the Clearance Zone but ultimately the concrete blocks will maintain the debris within the channels. Consideration into options such as chaining the blocks together to prevent shifting was reviewed but it was decided to leave the blocks independent to maintain accessibility for DFO. DFO is to place the concrete blocks back to their original location upon completing their maintenance if the blocks were moved to attain access to channels.

As construction of all proposed works is to occur outside the wetted extents of the 1 in 2-year flood, no regulatory application is required.

The arrangement presented herein is to mitigate the risks to Chilliwack Lake Road during a single design flood event. The design of the guide bank has been included in Appendix B.

Reference: 14096

5 Closure

This design of this guide bank provides a solution to DFO's maintenance and access requirements, water flow along the toe of the road embankment during design flood event and maintaining the Clearance Zone for road user's safety.

If the BC MoTI has any questions, please contact the authors of this document.

Regards,

STANTEC CONSULTING LTD.



Catalina Tandara C.E.T.
Design Technologist -- River Engineering
Phone: 403 716 8114
Catalina.Tandara@stantec.com

Matt Wood P.Eng.
Natural Systems Discipline Lead
Canada West Water Resource Practice
Lead
Phone: 403-870-9420
Matt.wood@stantec.com

Grant Irvine P.Eng.
Senior Technical Leda – Highway Design
& Construction
Phone: 250-371-1149
Grant.Irvine@stantec.com

Reference: 14096

Appendix A

Design Criteria Sheet for Climate Change Resilience

Highway Infrastructure Engineering Design and Climate Change Adaptation
 BC Ministry of Transportation and Infrastructure
 (Separate Criteria Sheet per Discipline)
 (Submit all sheets to the Chief Engineers Office at:
 BCMoTI-ChiefEngineersOffice@gov.bc.ca)

Project: 14096 Chilliwack Lake Road Flood Recovery – Site D Box Culvert
 Type of work: Channel Overbank Works
 Location: Chilliwack Lake Road 4.0km east of Tamhi Bridge
 Discipline: Hydrotechnical

Design Component	Design Life or Return Period	Design Criteria (Units)	Design Value Without Climate Change	Change in Design Value from Future Climate	Design Value Including Climate Change	Adaptation Cost Estimate (\$)	Comments / Notes / Deviations / Variances
Guide Bank and Armouring	1:200 yr RP	Intensity Rates (mm/hr)	17.4	24%	21.5	N/A	Taken from the IDF_CC Tool 6.0 for the years of 2022-2100
Guide Bank and Armouring	1:200 yr RP	Peak Flow Rate (m ³ /s)	28.3	24%	35.0	N/A	1:200 yr RP 2hr Time of Concentration

Explanatory Notes / Discussion:

Design Criteria

The design criteria for the project are based on the principals outlined in the BCMoTI Supplement to TAC Geometrics Design Guide – 1000 Hydraulics Chapter. This design is limited to a guide bank near to the toe of the road embankment. The design criteria noted below provides a summary of the key design items.

Hydrology

- Rainfall Intensity Duration Frequency (IDF) data was taken from *IDF_CC Tool 6.0** ungauged IDF for: Lat: 49.07663°, Lon: -121.78432 ° with climate change prediction for the years of 2022 – 2100.
- Time of concentration was calculated using the average from the BCMoTI Graph, Kirpich and SCS lag equations.
- Runoff coefficient, with snowmelt consideration, was calculated using values from Table 1020.A in the Supplement to TAC

Return Period

Design return period of 1:200 years was selected for the guide bank based on Table 1020.A in the Supplement to TAC .

IDF_CC Tool 6.0

The IDF_CC Tool 6.0* was used to estimate climate change related increases to rainfall intensities for the ungauged location to the year 2100. The ungauged data for the site IDF is provided by IDF_CC Tool 6.0, the program interpolates data from nearby gauged stations. The IDF_CC tool uses PCIC – Bias Corrected climate data assuming Representative Concentration Pathway (RCP) 8.5 emission scenario from Coupled Model Intercomparison Project (CMIP) 5. Rainfall intensities of the return periods 2-years to 100-years were used to extrapolate the rain fall intensity of a 2-hour storm duration at the 1 in 200-year return period, the estimated increase in rainfall intensity at the 1 in 200-year return period between historical and future is 24%.

Flow Estimate

Estimated the 1:200 year peak flow rate for the guide bank using the Rational Method. The design estimated peak flow rate with climate change consideration is estimated to be 35 m³/s, a 24% increase from historical (i.e., without climate change) peak flows.

The following IDF Tables were used:

Historical IDF

Ungauged IDF for: Lat: 49.07663 °, Lon: -121.78432 °

T (years)	2	5	10	20	25	50	100
5 min	2.85	3.81	4.53	5.32	5.76	6.44	7.41
10 min	4.29	5.73	6.80	7.97	8.33	9.63	11.07
15 min	5.42	7.07	8.26	9.53	9.91	11.26	12.72
30 min	7.80	9.95	11.45	13.03	13.49	15.13	16.90
1 h	11.14	13.96	15.95	18.05	18.67	20.86	23.22
2 h	17.30	21.20	23.28	26.16	27.10	29.61	32.18
6 h	35.38	41.28	44.68	47.78	48.52	51.07	53.10
12 h	53.00	60.47	71.72	78.69	80.38	86.98	93.23
24 h	74.42	95.71	110.14	124.73	128.96	143.45	158.36

Ungauged IDF for: Lat: 49.07663 °, Lon: -121.78432 °

T (years)	2	5	10	20	25	50	100
5 min	34.18	45.67	54.33	63.81	66.75	77.23	88.96
10 min	25.76	34.36	40.80	47.83	50.00	57.76	66.41
15 min	21.67	28.28	33.06	38.12	39.66	45.04	50.87
30 min	15.60	19.90	22.91	26.05	26.98	30.26	33.80
1 h	11.14	13.96	15.95	18.05	18.67	20.86	23.22
2 h	8.15	10.60	11.89	13.18	13.55	14.81	16.09
6 h	5.30	6.88	7.75	8.96	9.29	8.51	8.90
12 h	4.42	5.37	5.98	6.56	6.71	7.25	7.77
24 h	3.10	3.99	4.59	5.20	5.37	5.98	6.40

Climate Change IDF

Ungauged IDF for: Lat: 49.07663 °, Lon: -121.78432 °

T (years)	2	5	10	20	25	50	100
5 min	3.22	4.43	5.42	6.45	6.74	7.80	9.10
10 min	4.86	6.67	8.14	9.66	10.10	11.66	13.59
15 min	6.14	8.24	9.90	11.55	12.02	13.64	15.62
30 min	8.83	11.59	13.71	15.79	16.35	18.33	20.75
1 h	12.61	16.26	19.10	21.88	22.64	25.27	28.51
2 h	19.59	24.70	28.47	31.96	32.85	35.88	39.51
6 h	40.06	48.09	53.50	57.91	58.82	61.87	65.56
12 h	60.01	75.12	85.86	95.39	97.69	105.38	114.47
24 h	84.27	111.52	131.87	151.20	156.35	173.78	194.44

Ungauged IDF for: Lat: 49.07663 °, Lon: -121.78432 °

T (years)	2	5	10	20	25	50	100
5 min	38.70	53.22	65.05	77.35	80.93	93.58	109.23
10 min	29.17	40.03	48.84	57.98	60.62	69.98	81.55
15 min	24.54	32.95	39.58	46.21	48.08	54.57	62.47
30 min	17.66	23.19	27.43	31.58	32.71	36.66	41.90
1 h	12.61	16.26	19.10	21.88	22.64	25.27	28.51
2 h	9.80	12.35	14.24	15.98	16.43	17.94	19.76
6 h	6.68	8.02	8.92	9.65	9.80	10.31	10.93
12 h	5.00	6.26	7.16	7.95	8.14	8.78	9.34
24 h	3.51	4.65	5.49	6.30	6.51	7.24	8.10

*Simonovic, S.P., A. Schardong, R. Srivastav, and D. Sandink (2015), IDF_CC Web-based Tool for Updating Intensity-Duration-Frequency Curves to Changing Climate – ver 6.0, Western University Faculty for Intelligent Decision Support and Institute for Catastrophic Loss Reduction, open access <https://www.idf-cc-uwo.ca>.



Stantec Permit #1002862

Recommended by: Engineer of Record: _____
(Print Name / Provide Seal & Signature)

Date: February 17, 2023

Engineering Firm: Stantec Consulting Ltd.

Accepted by BCMoTI Consultant Liaison: _____
(For External Design)

Deviations and Variances Approved by the Chief Engineer: _____
Program Contact: Chief Engineer BCMoTI

Reference: 14096

Appendix B

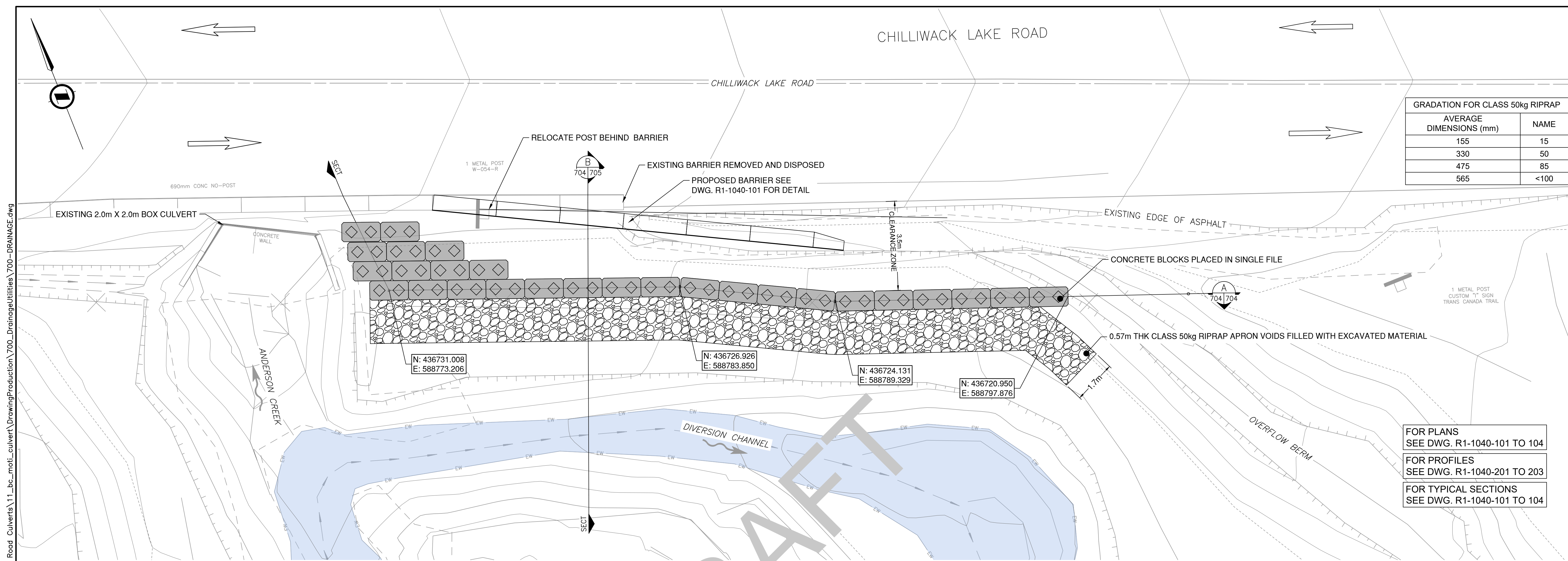

GRADATION FOR CLASS 50kg RIPRAP	
AVERAGE DIMENSIONS (mm)	NAME
155	15
330	50
475	85
565	<100

FOR PLANS
SEE DWG. R1-1040-101 TO 104

FOR PROFILES
SEE DWG. R1-1040-201 TO 203

FOR TYPICAL SECTIONS
SEE DWG. R1-1040-101 TO 104

PLAN
1:75

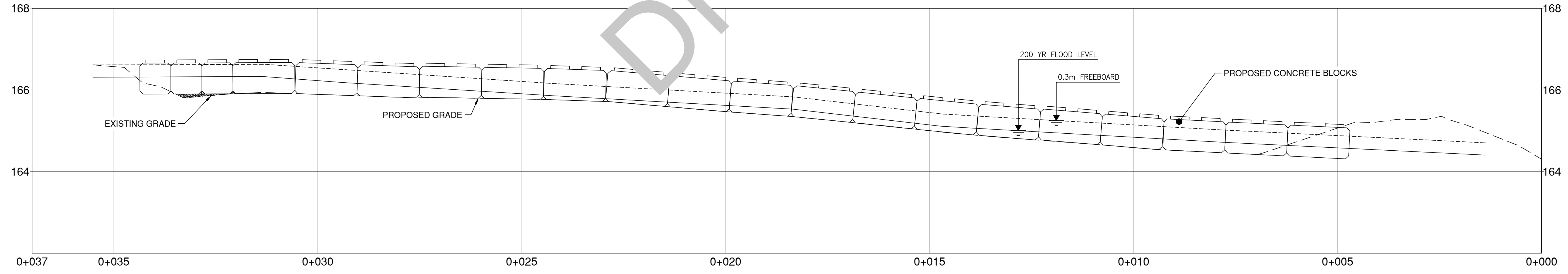

A
704 PROFILE
1:50

SCALE	0 0.5 1.50 2.5m		
CAD FILENAME	700-DRAINAGE		
PLOT DATE	2/24/2023		
REV	DATE	REVISIONS	NAME

BRITISH COLUMBIA
MINISTRY OF TRANSPORTATION AND INFRASTRUCTURE
SOUTH COAST REGION
HIGHWAY ENGINEERING AND GEOMATICS

DESIGNED: C.TANDARA DATE: 2023-02-19
QUALITY CONTROL: M.WOOD DATE: 2023-02-20
QUALITY ASSURANCE: J.BIGELOW DATE: 2023-02-21
DRAWN: B.WANG DATE: 2023-02-19

MATT WOOD, P.ENG
ENGINEER OF RECORD

CHANNEL PLAN AND PROFILE CHILLIWACK LAKE ROAD FLOOD RECOVERY				
SITE D				
FILE NUMBER	PROJECT NUMBER	REG	DRAWING NUMBER	REV
872CS1658	14095-0002	1	R1-1040-704	



100% DETAILED DESIGN

PLOT DATE: 2023/02/24 \\CA0049-PPFSS01\workgroup\1158\active\1158\active\115820085\02_active_tasks\1000_Chilliwack Lake Road Culverts\11_bc_moti_culvert\DrawingProduction\700_Drainage\Utilities\700-DRAINAGE.dwg

PLOT DATE: 2023/02/24 \\CA0049-PPFSS01\workgroup\1158\active\115820085\02_active_tasks\1000_Chilliwack Lake Road Culverts\11_bc_moti_culvert\DrawingProduction\700_Drainage\Utilities\700-DRAINAGE.dwg

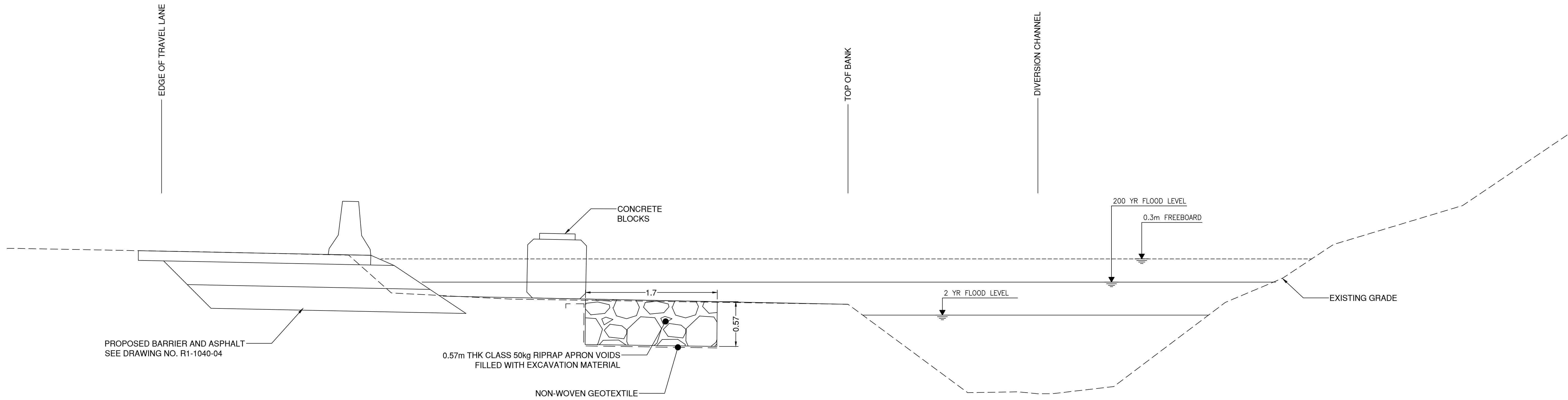

B SECTION
704 1:25

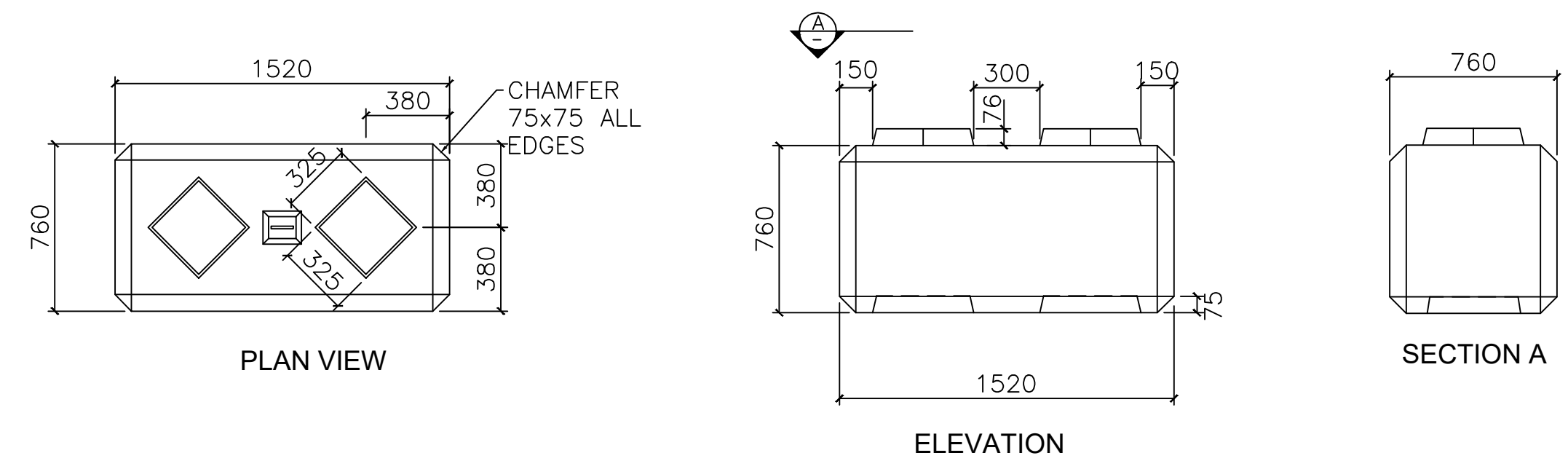

CONCRETE BLOCK DETAIL
NTS

FOR PLANS
SEE DWG. R1-1040-101 TO 104

FOR PROFILES
SEE DWG. R1-1040-201 TO 203

FOR TYPICAL SECTIONS
SEE DWG. R1-1040-101 TO 104

DRAFT



100% DETAILED DESIGN

SCALE		0 0.25 1:25 1.25m		CAD FILENAME	700-DRAINAGE
				PLOT DATE	2/24/2023
REV	DATE	REVISIONS	NAME		

BRITISH COLUMBIA
MINISTRY OF TRANSPORTATION AND INFRASTRUCTURE
SOUTH COAST REGION
HIGHWAY ENGINEERING AND GEOMATICS

DESIGNED: C.TANDARA DATE: 2023-02-19
 QUALITY CONTROL: M.WOOD DATE: 2023-02-20
 QUALITY ASSURANCE: J.BIGELOW DATE: 2023-02-21
 DRAWN: B.WANG DATE: 2023-02-19

MATT WOOD, P.ENG
ENGINEER OF RECORD

CHANNEL SECTION & DETAIL CHILLIWACK LAKE ROAD FLOOD RECOVERY				
SITE D				
FILE NUMBER	PROJECT NUMBER	REG	DRAWING NUMBER	REV
872CS1658	14095-0002	1	R1-1040-705	