

LEGEND

	TRAFFIC ACCOMMODATION
	CONSTRUCTION (ROADWAY)
	REMOVAL (SURCHARGE)

TRAFFIC OPERATION
 -MAINTAIN EXISTING TRAFFIC OPERATIONS ON HIGHWAY 11 AND SUMAS WAY, MACLURE RD., TURNER ST., INDUSTRIAL/HAZELWOOD AVE. AND McCALLUM RD.

CONSTRUCTION OPERATION
 -REMOVE SURCHARGE

NDLEA Consultants Ltd.
 1455 WEST GEORGIA STREET, VANCOUVER, BC V6G 2T3 TEL. (604) 685-9381

DESIGNED RF DATE FEB/05
 CHECKED MCS DATE AUG/05
 DRAWN SM DATE FEB/05
 REVIEWED SW DATE MAR/05

Rev	Date	Description	Signature

REVISIONS

MINISTRY OF TRANSPORTATION
 HIGHWAY DESIGN AND SURVEY ENGINEERING
 SOUTH COAST REGION

SUGGESTED DETOURS AND STAGING
 MISSION-ABBOTSFORD HIGHWAY No. 11
 SUMAS WAY TO CLAYBURN ROAD
STAGE 1

SENIOR DESIGNER: *[Signature]* DATE: MARCH 31, 2006

FILE No. 11313	PROJECT No. 11313-0001	REG. 1	DRAWING No. R1-491-750
-------------------	---------------------------	-----------	---------------------------

CANCEL PRINTS BEARING PREVIOUS LETTER

FILE: 81573M901

UPDATE: MAR 31, 2006

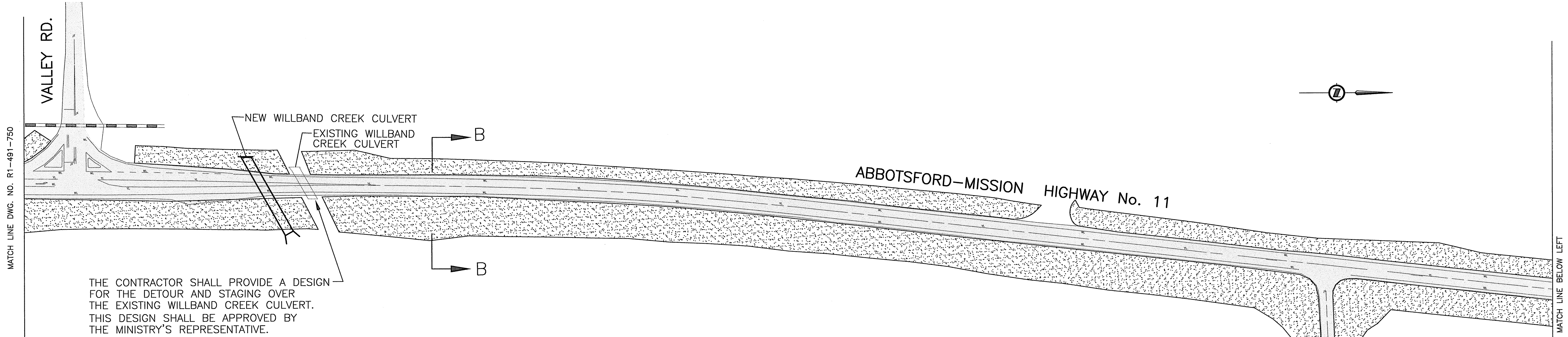

THE CONTRACTOR SHALL PROVIDE A DESIGN FOR THE DETOUR AND STAGING OVER THE EXISTING WILLBAND CREEK CULVERT. THIS DESIGN SHALL BE APPROVED BY THE MINISTRY'S REPRESENTATIVE.

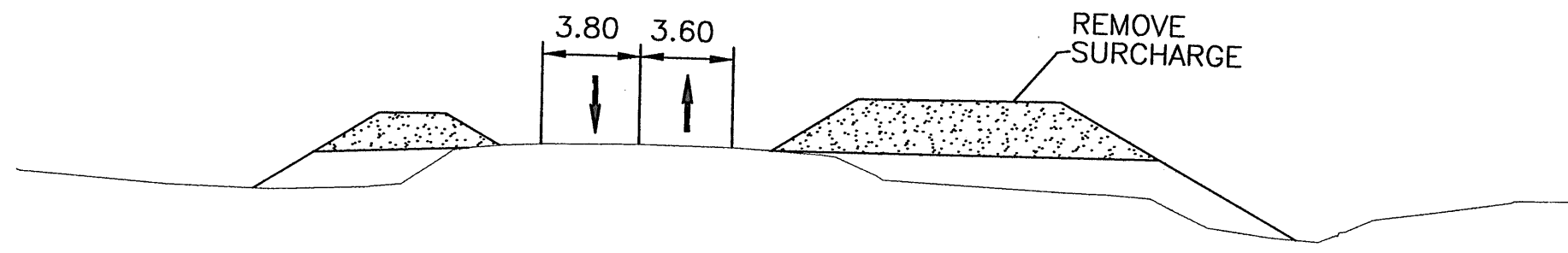

SECTION B-B
SCALE 1:250

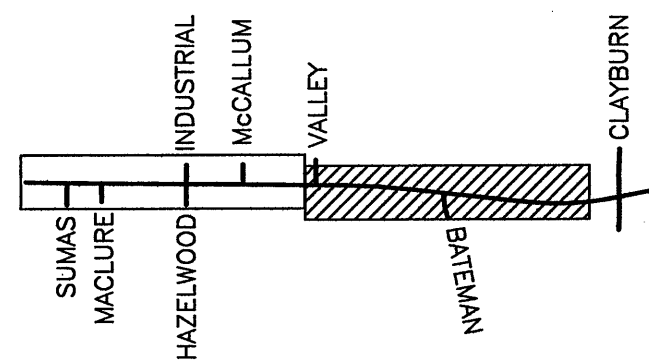
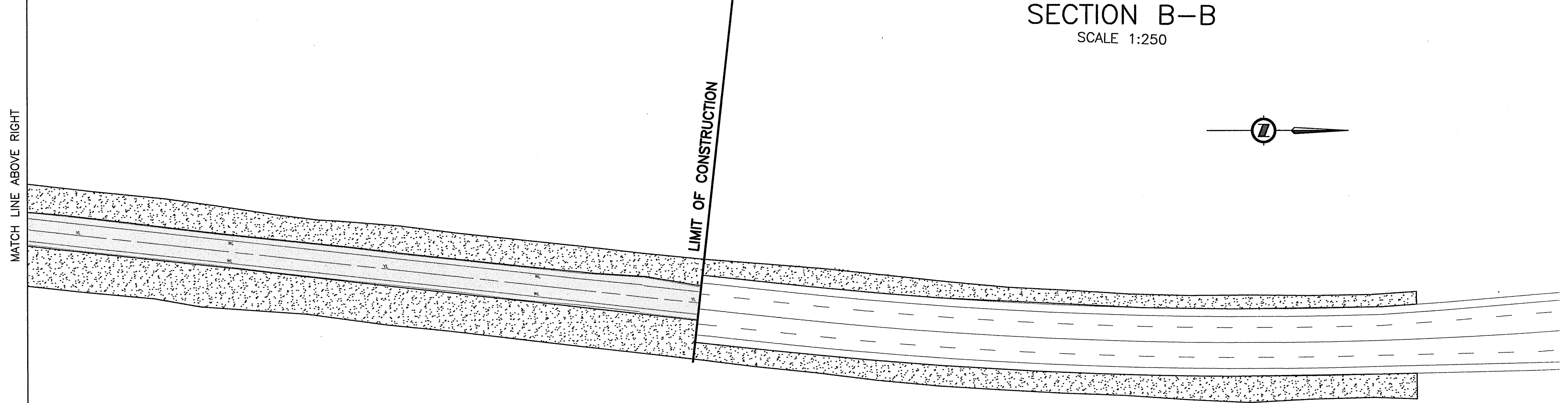

KEY PLAN
SCALE N.T.S.

LEGEND

- TRAFFIC ACCOMMODATION
- CONSTRUCTION (ROADWAY)
- REMOVAL (SURCHARGE)

TRAFFIC OPERATION

—MAINTAIN EXISTING TRAFFIC OPERATIONS ON HIGHWAY 11, VALLEY RD. AND BATEMAN RD.

CONSTRUCTION OPERATION

—REMOVE SURCHARGE

NDLEA Consultants Ltd.
1455 WEST GEORGIA STREET, VANCOUVER, BC V6G 2T3 TEL. (604) 685-9381

DESIGNED: RF DATE FEB/05
 CHECKED: MCS DATE AUG/05
 DRAWN: SM DATE FEB/05
 REVIEWED: SW DATE MAR/05

Rev	Date	Description	Signature

REVISIONS

MINISTRY OF TRANSPORTATION
 HIGHWAY DESIGN AND SURVEY ENGINEERING
 SOUTH COAST REGION

SUGGESTED DETOURS AND STAGING
 MISSION-ABBOTSFORD HIGHWAY No. 11
 SUMAS WAY TO CLAYBURN ROAD
STAGE 1

DATE: MARCH 31, 2006

FILE No. 11313	PROJECT No. 11313-0001	REG. 1	DRAWING No. R1-491-751
-------------------	---------------------------	-----------	---------------------------

CANCEL PRINTS BEARING PREVIOUS LETTER

FILE: 81573M802

UPDATE: MAR 31, 2006

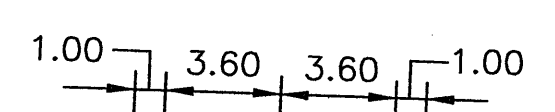
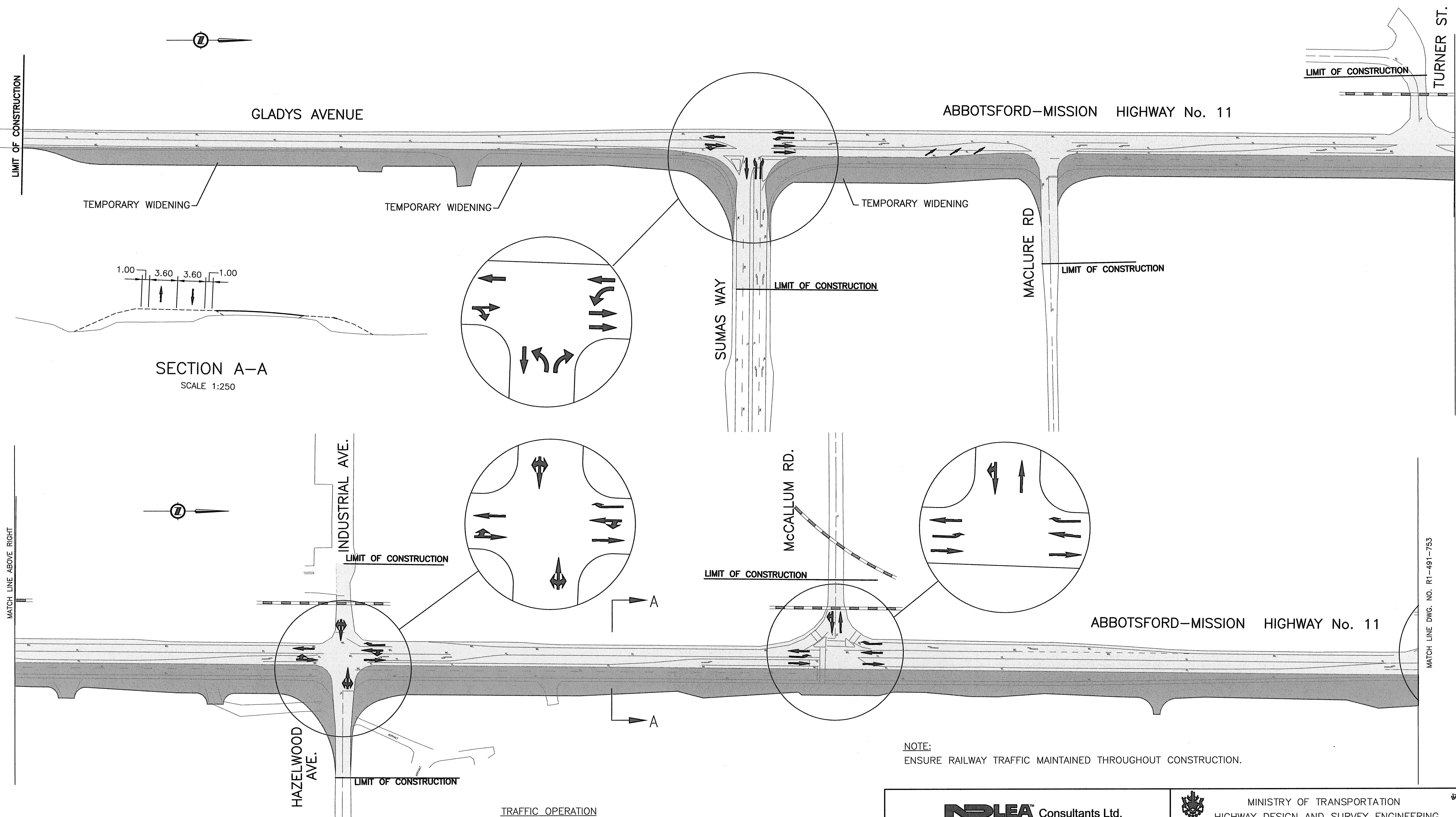

SECTION A-A
SCALE 1:250

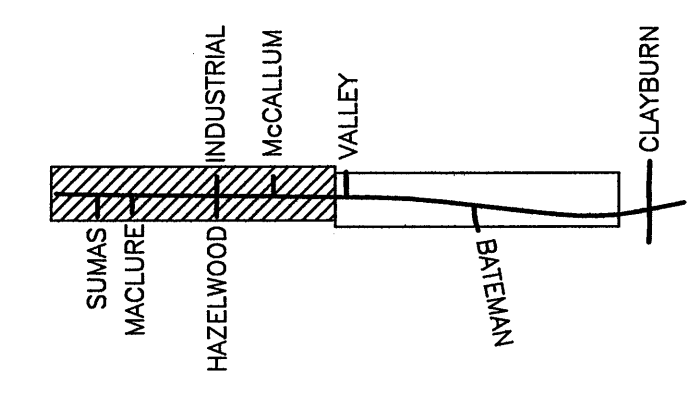
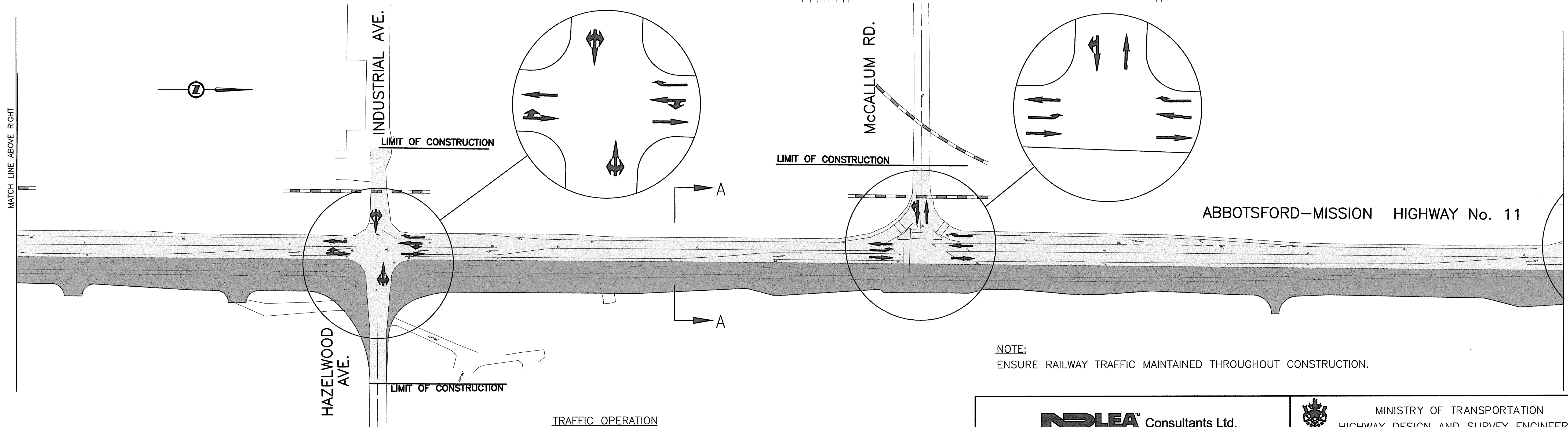

KEY PLAN
SCALE N.T.S.

- LEGEND**
- TRAFFIC ACCOMMODATION
 - CONSTRUCTION (ROADWAY)

- TRAFFIC OPERATION**
- SHIFT TRAFFIC TO WEST SIDE OF HIGHWAY 11.
- CONSTRUCTION OPERATION**
- RECONSTRUCT EAST SIDE OF HIGHWAY 11 AND SUMAS WAY INTERSECTION, EXCEPT ISLANDS
 - CONSTRUCT TO ULTIMATE ON EAST SIDE WIDENING.
 - CONSTRUCT TEMPORARY WIDENING EAST SIDE OF HWY 11, SOUTH OF MACLURE ROAD.

NOTE:
ENSURE RAILWAY TRAFFIC MAINTAINED THROUGHOUT CONSTRUCTION.

NDLEA Consultants Ltd.
1455 WEST GEORGIA STREET, VANCOUVER, BC V6G 2T3 TEL. (604) 685-9381

DESIGNED RF DATE FEB/05
CHECKED MCS DATE AUG/05
DRAWN SM DATE FEB/05
REVIEWED SW DATE MAR/05

Rev	Date	Description	Signature

REVISIONS

MINISTRY OF TRANSPORTATION
HIGHWAY DESIGN AND SURVEY ENGINEERING
SOUTH COAST REGION

SUGGESTED DETOURS AND STAGING
MISSION-ABBOTSFORD HIGHWAY No. 11
SUMAS WAY TO CLAYBURN ROAD
STAGE 2

SENOR DESIGNER: *R. G. G.* DATE: MARCH 31, 2006

FILE No. 11313	PROJECT No. 11313-0001	REG. 1	DRAWING No. R1-491-752
-------------------	---------------------------	-----------	---------------------------

CANCEL PRINTS BEARING PREVIOUS LETTER

FILE: 81573M903

UPDATE: MAR 31, 2006

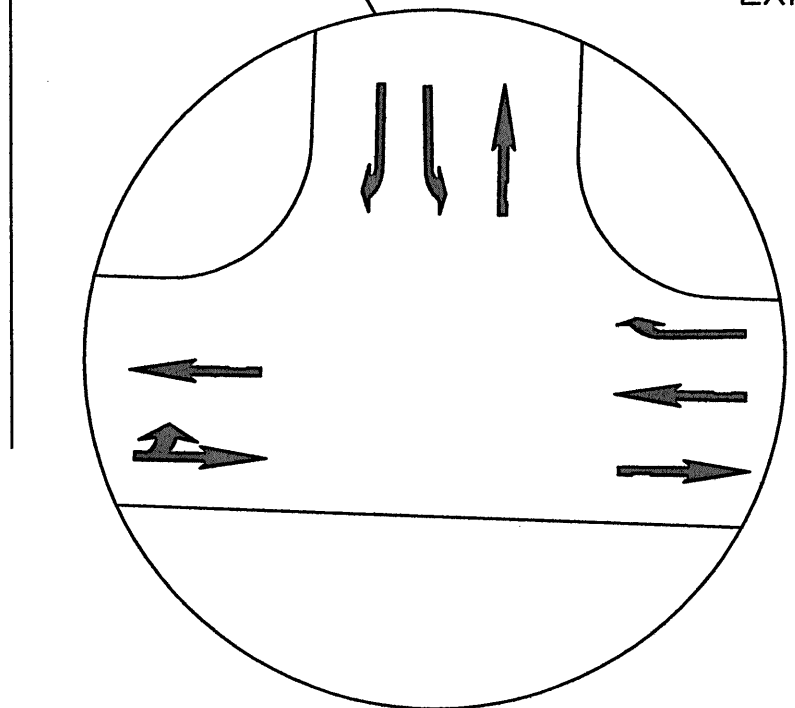
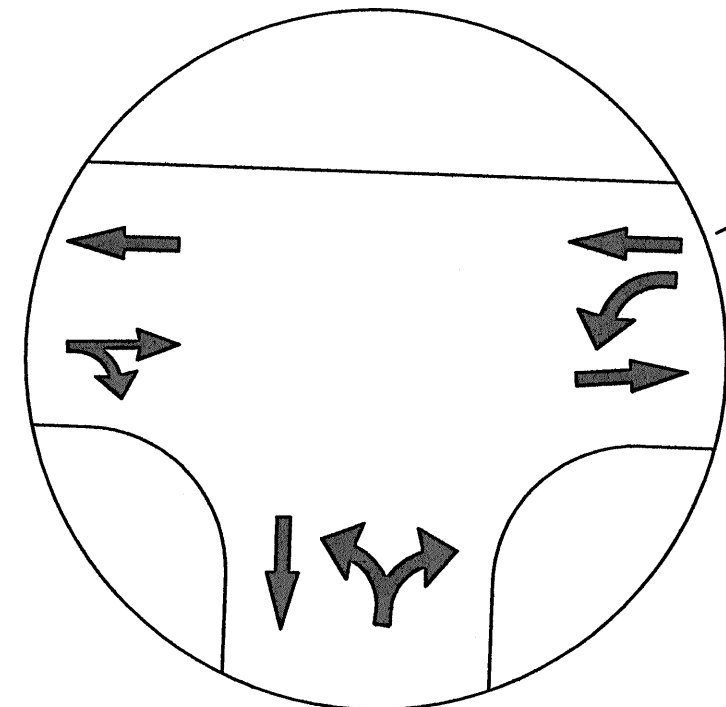
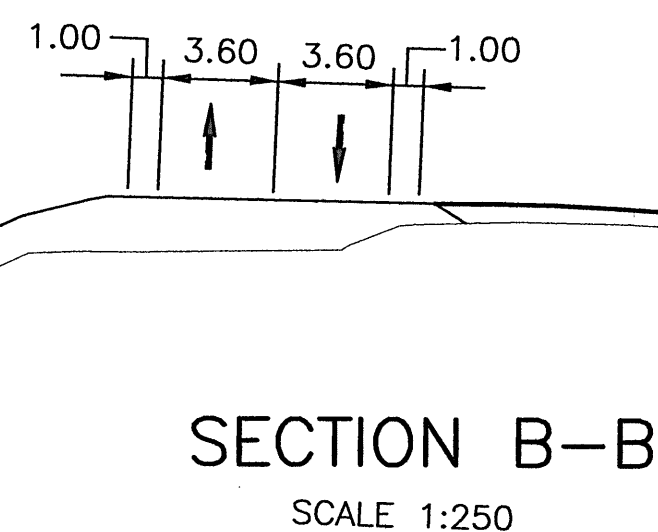
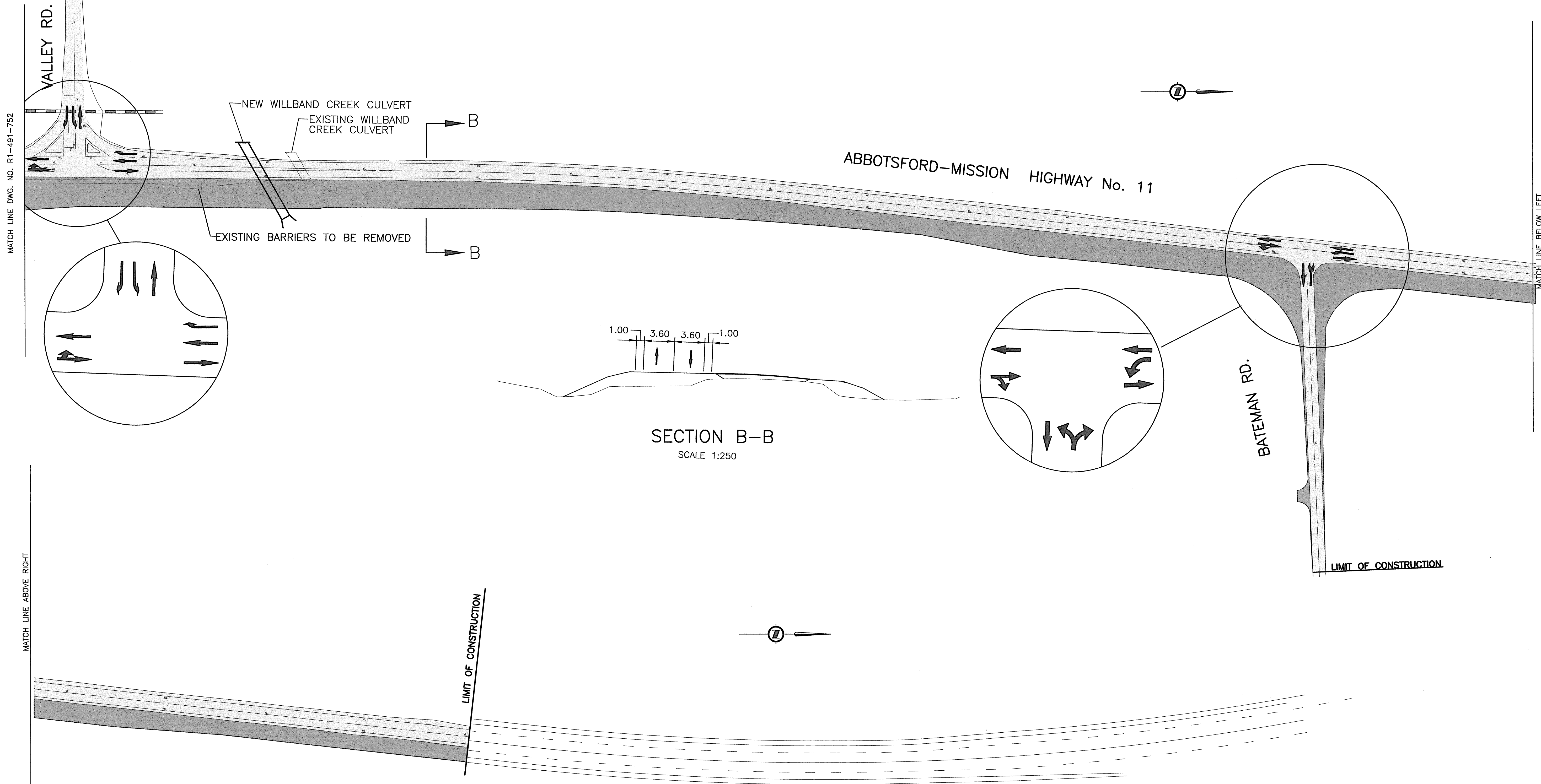

NOTE:
ENSURE RAILWAY TRAFFIC MAINTAINED THROUGHOUT CONSTRUCTION.

TRAFFIC OPERATION
-SHIFT TRAFFIC TO WEST SIDE OF HIGHWAY 11.

CONSTRUCTION OPERATION
-CONSTRUCT TO ULTIMATE ON EAST SIDE WIDENING.
-REMOVE BARRIERS ON EAST SIDE OF HWY 11 NEAR VALLEY RD.

LEGEND

□ TRAFFIC ACCOMMODATION

■ CONSTRUCTION (ROADWAY)

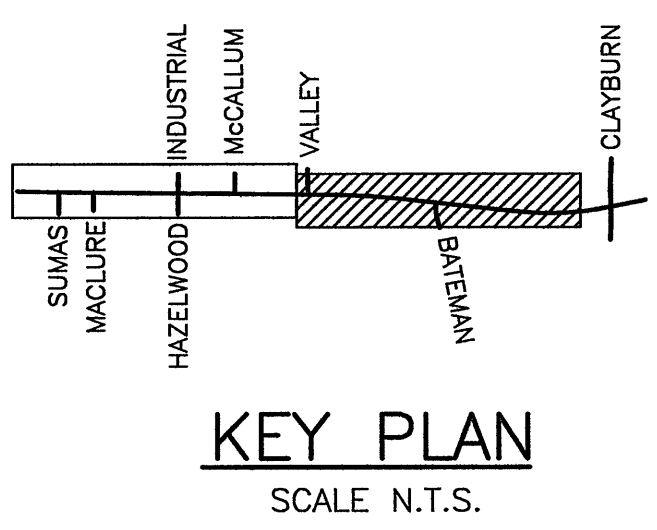

1455 WEST GEORGIA STREET, VANCOUVER, BC V6G 2T3 TEL. (604) 685-9381		MINISTRY OF TRANSPORTATION HIGHWAY DESIGN AND SURVEY ENGINEERING SOUTH COAST REGION																													
SCALE 0 1:1000 50		SUGGESTED DETOURS AND STAGING MISSION-ABBOTSFORD HIGHWAY No. 11 SUMAS WAY TO CLAYBURN ROAD STAGE 2																													
DESIGNED RF DATE FEB/05 CHECKED MCS DATE AUG/05 DRAWN SM DATE FEB/05 REVIEWED SW DATE MAR/05		SENIOR DESIGNER [Signature] DATE MARCH 31, 2006																													
<table border="1"> <thead> <tr> <th>Rev</th> <th>Date</th> <th>Description</th> <th>Signature</th> </tr> </thead> <tbody> <tr><td> </td><td> </td><td> </td><td> </td></tr> <tr><td> </td><td> </td><td> </td><td> </td></tr> <tr><td> </td><td> </td><td> </td><td> </td></tr> <tr><td> </td><td> </td><td> </td><td> </td></tr> </tbody> </table>		Rev	Date	Description	Signature																	<table border="1"> <tr> <td>FILE No.</td> <td>PROJECT No.</td> <td>REG.</td> <td>DRAWING No.</td> </tr> <tr> <td>11313</td> <td>11313-0001</td> <td>1</td> <td>R1-491-753</td> </tr> </table>		FILE No.	PROJECT No.	REG.	DRAWING No.	11313	11313-0001	1	R1-491-753
Rev	Date	Description	Signature																												
FILE No.	PROJECT No.	REG.	DRAWING No.																												
11313	11313-0001	1	R1-491-753																												
REVISIONS		UPDATE : MAR 31, 2006																													

CANCEL PRINTS BEARING PREVIOUS LETTER

FILE: 81573M804

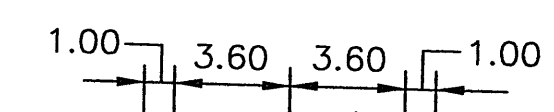
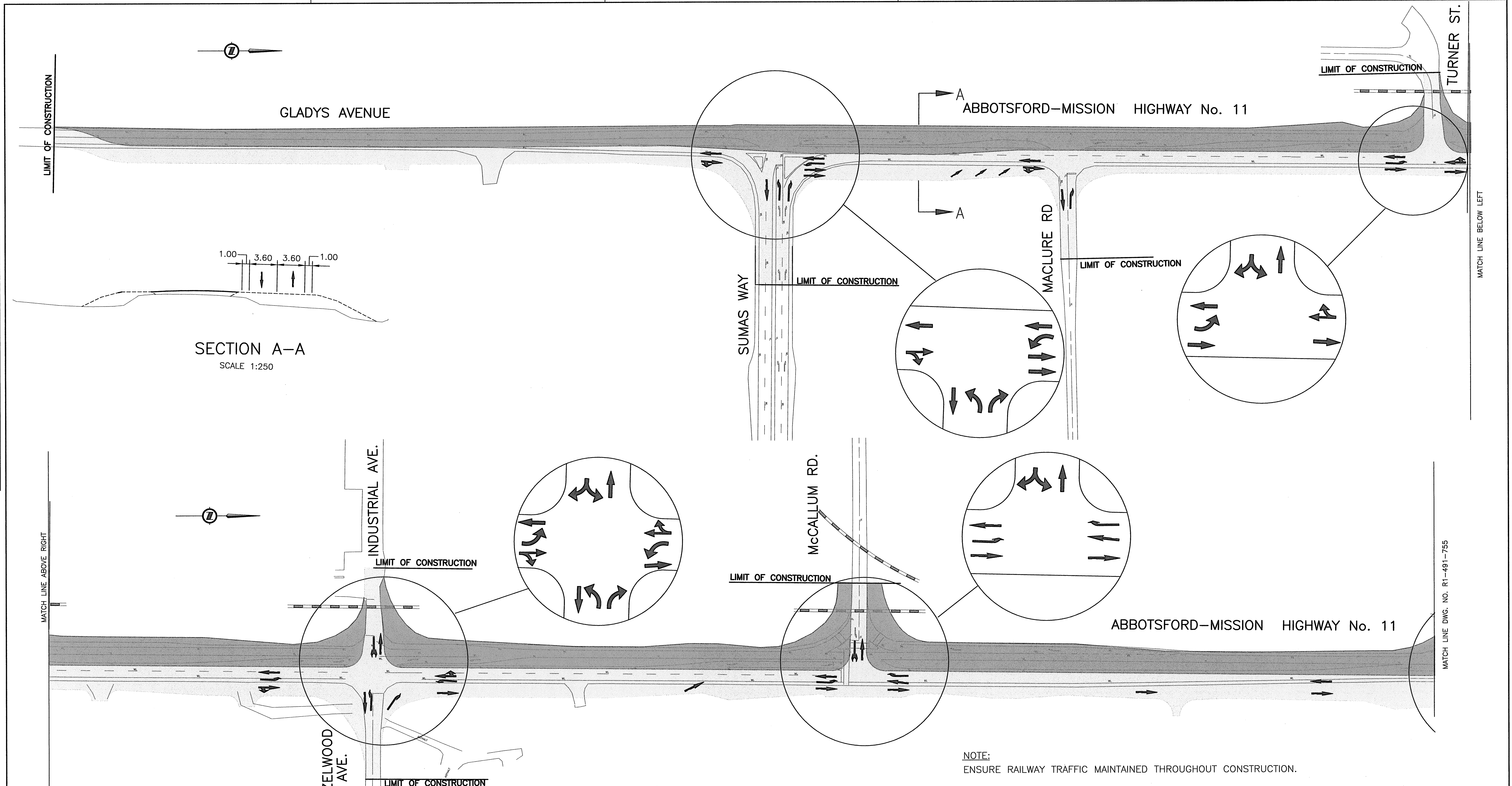

SECTION A-A
SCALE 1:250

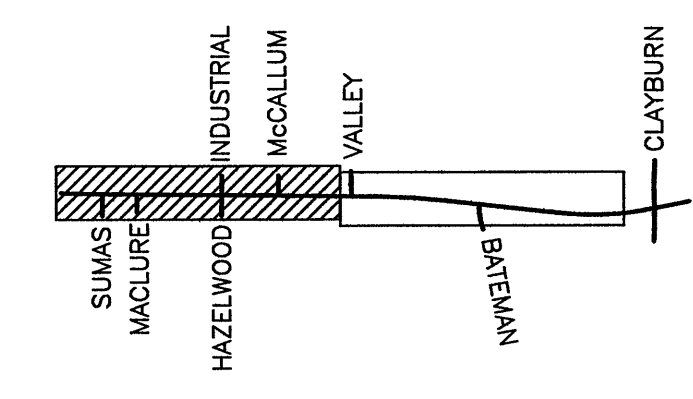

KEY PLAN
SCALE N.T.S.

LEGEND

- TRAFFIC ACCOMMODATION
- CONSTRUCTION (ROADWAY)

TRAFFIC OPERATION

- SHIFT TRAFFIC TO NEWLY CONSTRUCTED EAST SIDE OF HIGHWAY 11.
- MACLURE RD CHANGED TO RIGHT IN RIGHT OUT OPERATION.

CONSTRUCTION OPERATION

- RECONSTRUCT WEST SIDE OF HIGHWAY 11, EXCEPT ISLANDS AT INDUSTRIAL AVE. AND McCALLUM RD.
- CONSTRUCT TO ULTIMATE ON WEST SIDE WIDENING.

NOTE:
ENSURE RAILWAY TRAFFIC MAINTAINED THROUGHOUT CONSTRUCTION.

NDLEA Consultants Ltd.
1455 WEST GEORGIA STREET, VANCOUVER, BC V6G 2T3 TEL. (604) 685-9381

DESIGNED: RF DATE FEB/05
CHECKED: MCS DATE AUG/05
DRAWN: SM DATE FEB/05
REVIEWED: SW DATE MAR/05

Rev	Date	Description	Signature

REVISIONS

MINISTRY OF TRANSPORTATION
HIGHWAY DESIGN AND SURVEY ENGINEERING
SOUTH COAST REGION

SUGGESTED DETOURS AND STAGING
MISSION-ABBOTSFORD HIGHWAY No. 11
SUMAS WAY TO CLAYBURN ROAD
STAGE 3

DATE: MARCH 31, 2006

FILE No. 11313	PROJECT No. 11313-0001	REG. 1	DRAWING No. R1-491-754
-------------------	---------------------------	-----------	---------------------------

SENIOR DESIGNER: [Signature] DATE: MARCH 31, 2006

CANCEL PRINTS BEARING PREVIOUS LETTER

FILE: B1573M905

UPDATE: MAR 31, 2006

MATCH LINE DWG. NO. R1-491-754

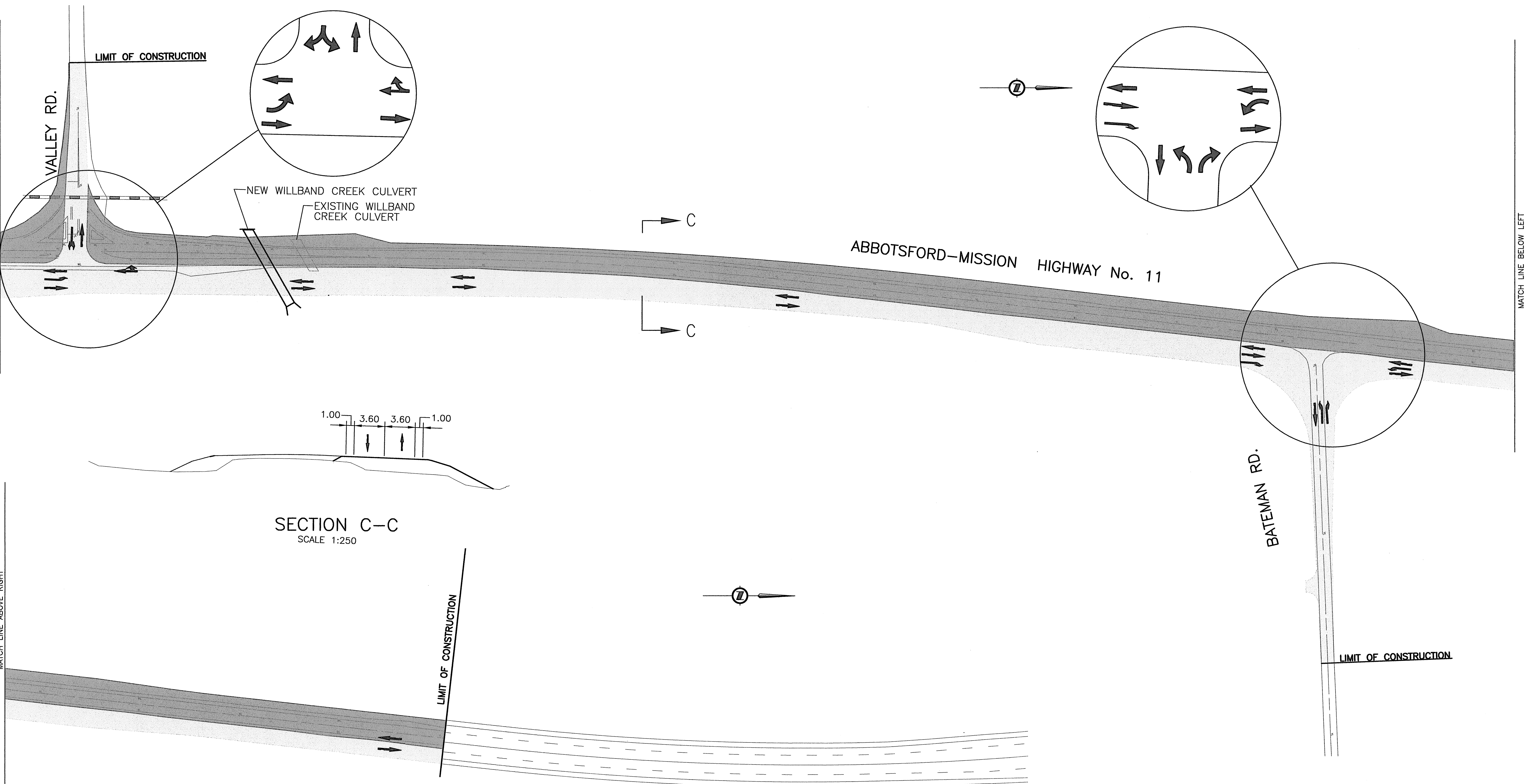

1.00 3.60 3.60 1.00

SECTION C-C
SCALE 1:250

MATCH LINE ABOVE RIGHT

LIMIT OF CONSTRUCTION

LIMIT OF CONSTRUCTION

NOTE:
ENSURE RAILWAY TRAFFIC MAINTAINED THROUGHOUT CONSTRUCTION.

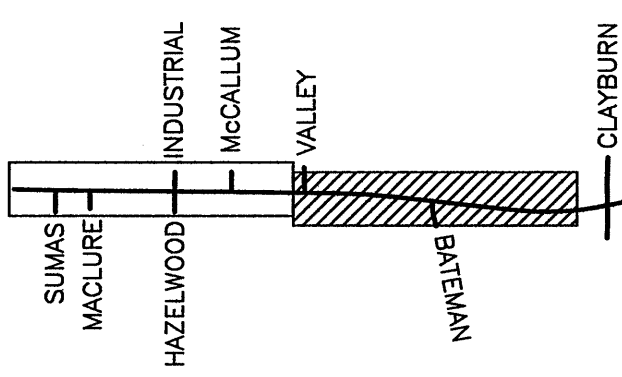

KEY PLAN
SCALE N.T.S.

- LEGEND**
- TRAFFIC ACCOMMODATION
 - CONSTRUCTION (ROADWAY)
 - EXISTING HWY 11 WIDENING INTERFACE (0.4m GRADE DIFFERENCE)

- TRAFFIC OPERATION**
- SHIFT TRAFFIC TO NEWLY CONSTRUCTED EAST SIDE OF HIGHWAY 11.
- CONSTRUCTION OPERATION**
- RECONSTRUCT WEST SIDE OF HIGHWAY 11.
 - CONSTRUCT TO ULTIMATE ON WEST SIDE WIDENING.

 1455 WEST GEORGIA STREET, VANCOUVER, BC V6G 2T3 TEL. (604) 685-9381		 MINISTRY OF TRANSPORTATION HIGHWAY DESIGN AND SURVEY ENGINEERING SOUTH COAST REGION	
SCALE 0 1:1000 50 		SUGGESTED DETOURS AND STAGING MISSION-ABBOTSFORD HIGHWAY No. 11 SUMAS WAY TO CLAYBURN ROAD STAGE 3	
DESIGNED RF DATE FEB/05 CHECKED MCS DATE AUG/05 DRAWN SM DATE FEB/05 REVIEWED SW DATE MAR/05		SENIOR DESIGNER DATE MARCH 31, 2006	
REVISIONS		FILE No. 11313	PROJECT No. 11313-0001
		REG. 1	DRAWING No. R1-491-755
CANCEL PRINTS BEARING PREVIOUS LETTER			

FILE: B1573M906

UPDATE: MAR 31, 2006

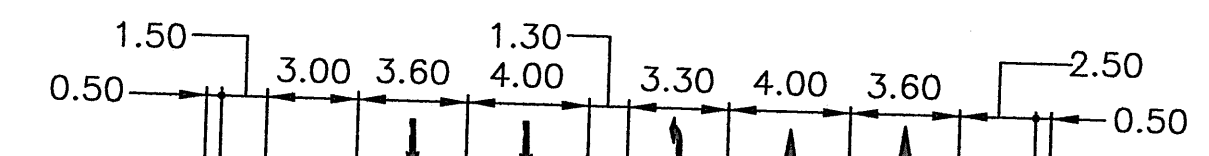
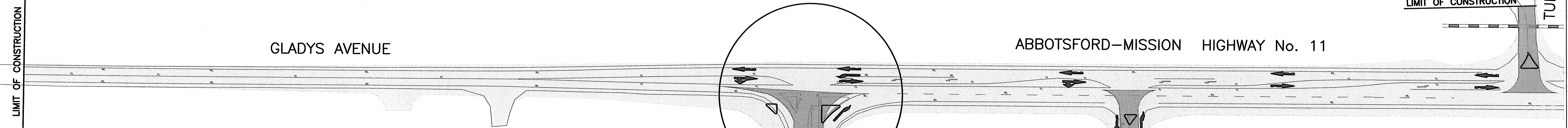
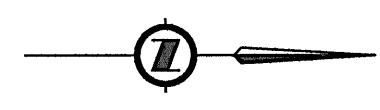

SECTION A-A
ULTIMATE SECTION
SCALE 1:250

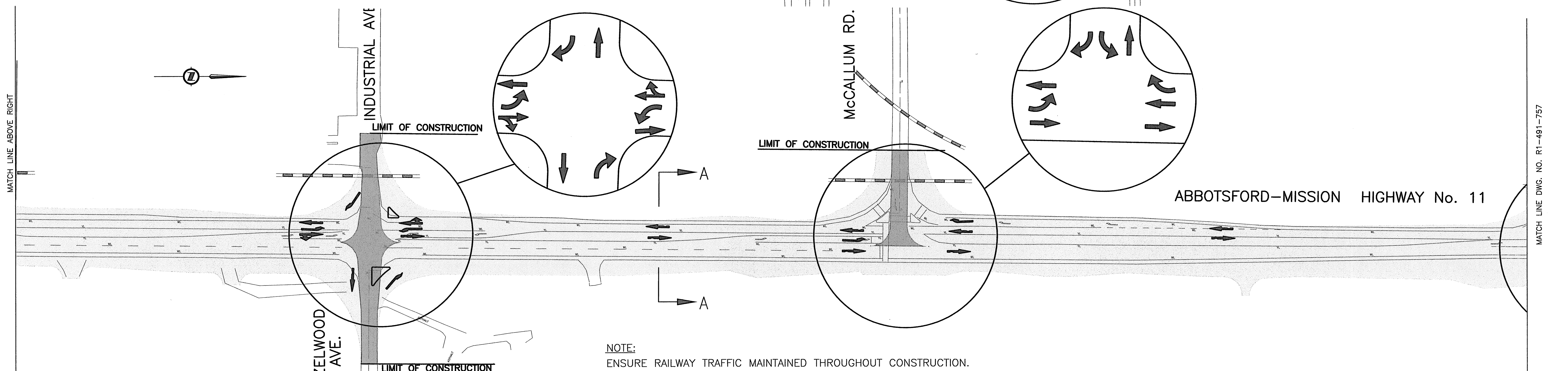

NOTE:
ENSURE RAILWAY TRAFFIC MAINTAINED THROUGHOUT CONSTRUCTION.

TRAFFIC OPERATION

- SHIFT TRAFFIC AS REQUIRED.
- TURNER ST. CHANGED TO RIGHT IN RIGHT OUT OPERATION ONCE DEDICATED LEFT TURN LANE RE-ESTABLISHED AT McCALLUM RD.

CONSTRUCTION OPERATION

- RECONSTRUCT SUMAS WAY, MACLURE RD, TURNER ST, HAZELWOOD AVE, INDUSTRIAL AVE AND McCALLUM RD.
- CONSTRUCT ISLANDS AT INDUSTRIAL AVE. AND McCALLUM RD. ONCE TRAFFIC MOVED TO ULTIMATE LOCATION.

LEGEND

- TRAFFIC ACCOMMODATION
- CONSTRUCTION (ROADWAY)

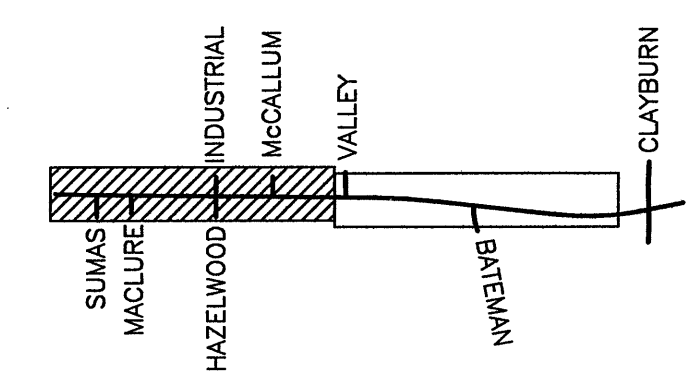

KEY PLAN
SCALE N.T.S.

NDLEA Consultants Ltd.
1455 WEST GEORGIA STREET, VANCOUVER, BC V6G 2T3 TEL. (604) 685-9381

DESIGNED	RF	DATE	FEB/05
CHECKED	MCS	DATE	AUG/05
DRAWN	SM	DATE	FEB/05
REVIEWED	SW	DATE	MAR/05

Rev	Date	Description	Signature

REVISIONS

MINISTRY OF TRANSPORTATION
HIGHWAY DESIGN AND SURVEY ENGINEERING
SOUTH COAST REGION

SUGGESTED DETOURS AND STAGING
MISSION-ABBOTSFORD HIGHWAY No. 11
SUMAS WAY TO CLAYBURN ROAD
STAGE 4

SENIOR DESIGNER: *[Signature]* DATE: MARCH 31, 2006

FILE No.	PROJECT No.	REG.	DRAWING No.
11313	11313-0001	1	R1-491-756

UPDATE : MAR 31, 2006

CANCEL PRINTS BEARING PREVIOUS LETTER

FILE: 81573M907

MATCH LINE DWG. NO. R1-491-756

MATCH LINE BELOW LEFT

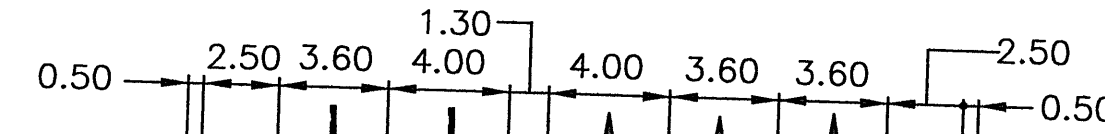
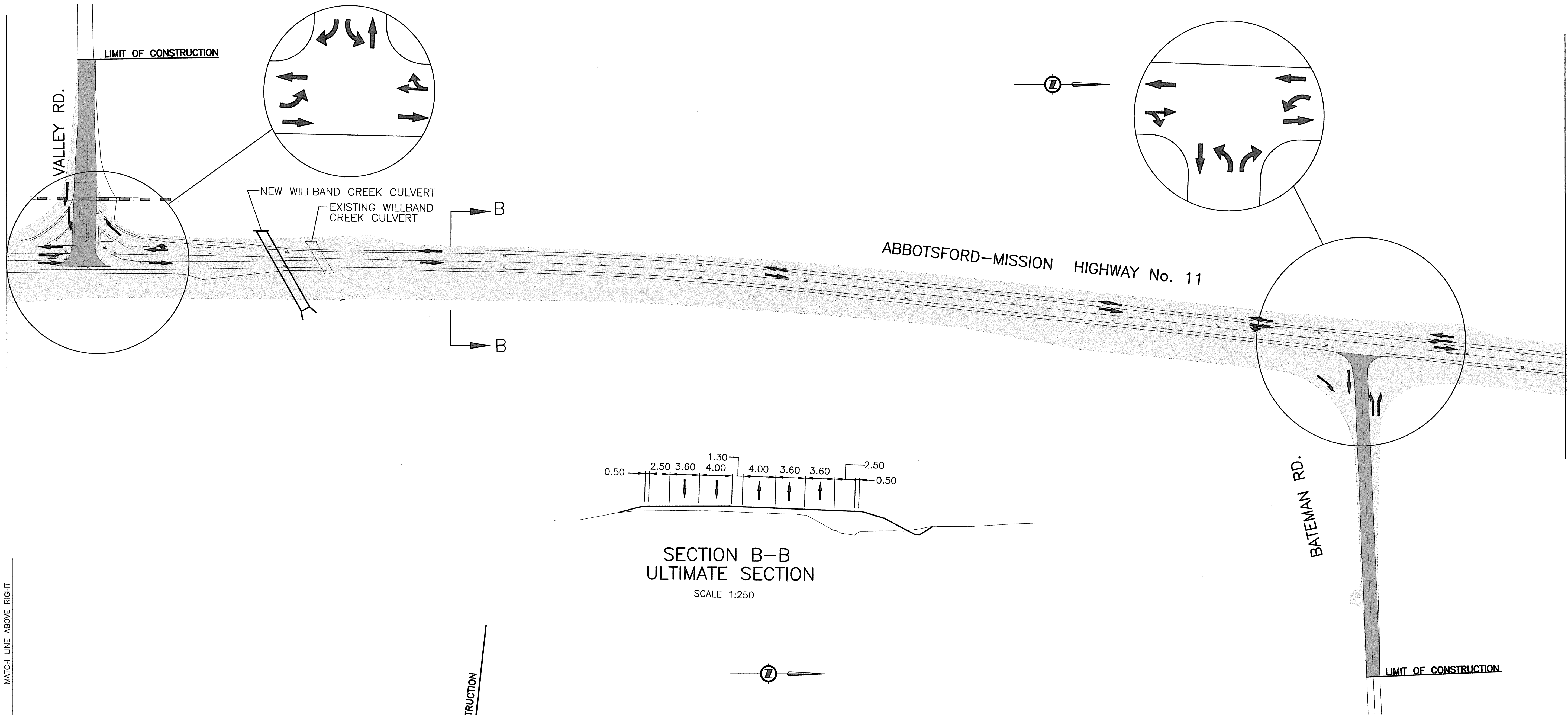

SECTION B-B
ULTIMATE SECTION
SCALE 1:250

MATCH LINE ABOVE RIGHT

LIMIT OF CONSTRUCTION

NOTE:
ENSURE RAILWAY TRAFFIC MAINTAINED THROUGHOUT CONSTRUCTION.

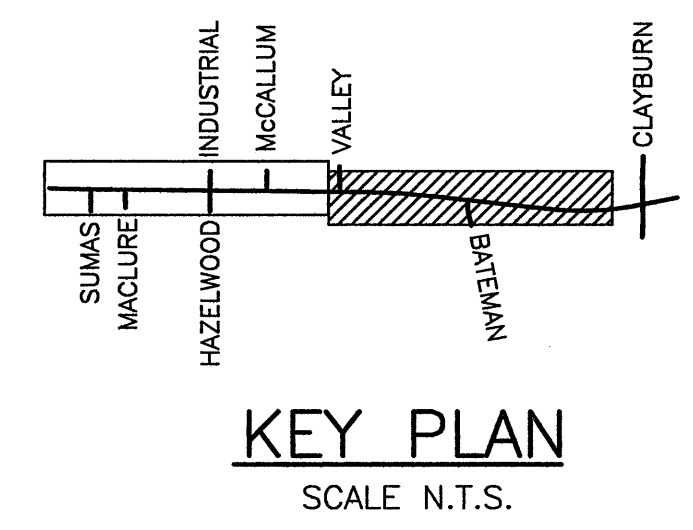

LEGEND

	TRAFFIC ACCOMMODATION
	CONSTRUCTION (ROADWAY)

TRAFFIC OPERATION
-SHIFT TRAFFIC AS REQUIRED.

CONSTRUCTION OPERATION
-RECONSTRUCT VALLEY RD AND BATEMAN RD.

 1455 WEST GEORGIA STREET, VANCOUVER, BC V6G 2T3 TEL. (604) 685-9381		 MINISTRY OF TRANSPORTATION HIGHWAY DESIGN AND SURVEY ENGINEERING SOUTH COAST REGION																					
SCALE 0 1:1000 50 		DESIGNED RF DATE FEB/05 CHECKED MCS DATE AUG/05 DRAWN SM DATE FEB/05 REVIEWED SW DATE MAR/05																					
<table border="1"> <thead> <tr> <th>Rev</th> <th>Date</th> <th>Description</th> <th>Signature</th> </tr> </thead> <tbody> <tr><td> </td><td> </td><td> </td><td> </td></tr> <tr><td> </td><td> </td><td> </td><td> </td></tr> <tr><td> </td><td> </td><td> </td><td> </td></tr> <tr><td> </td><td> </td><td> </td><td> </td></tr> </tbody> </table>		Rev	Date	Description	Signature																	SUGGESTED DETOURS AND STAGING MISSION-ABBOTSFORD HIGHWAY No. 11 SUMAS WAY TO CLAYBURN ROAD STAGE 4	
Rev	Date	Description	Signature																				
SENIOR DESIGNER DATE MARCH 31, 2006		FILE No. 11313	PROJECT No. 11313-0001 REG. 1 DRAWING No. R1-491-757																				
REVISIONS																							
CANCEL PRINTS BEARING PREVIOUS LETTER																							

FILE: B1573M908

UPDATE: MAR 31, 2006