



Ministry of
Transportation
and Infrastructure

PROJECT NO. 14005

FLUME CREEK DFAA FLOOD DAMAGE DESIGN SECTIONS

ISSUED FOR
100% DESIGN
2024-01-26
urbansystems.ca

Refer to Tender Drawing Package Approval Form DIRECTOR, ENGINEERING DATE	Refer to Tender Drawing Package Approval Form REGIONAL DIRECTOR DATE
--	--

DRAWING NUMBER	REV
R1-1027-0000	

PLOT DATE: 2024/01/25 U:\Projects_SUR\1961\0480\14\0-Design\CAD\DrawingProduction\1000_DesignSections\R1-1027-1000.dwg

PLOT DATE: 2024/01/25 U:\Projects_SUR\1961\0480\14\0-Design\CAD\DrawingProduction\1000_DesignSections\R1-1027-1000.dwg

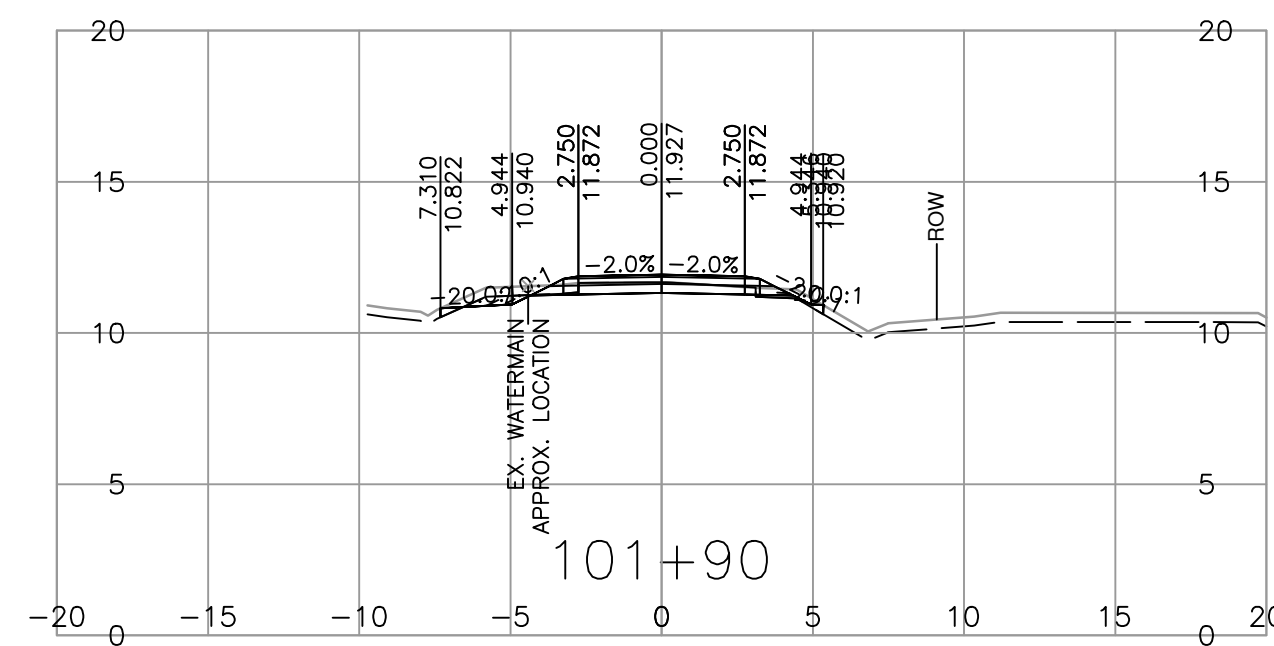
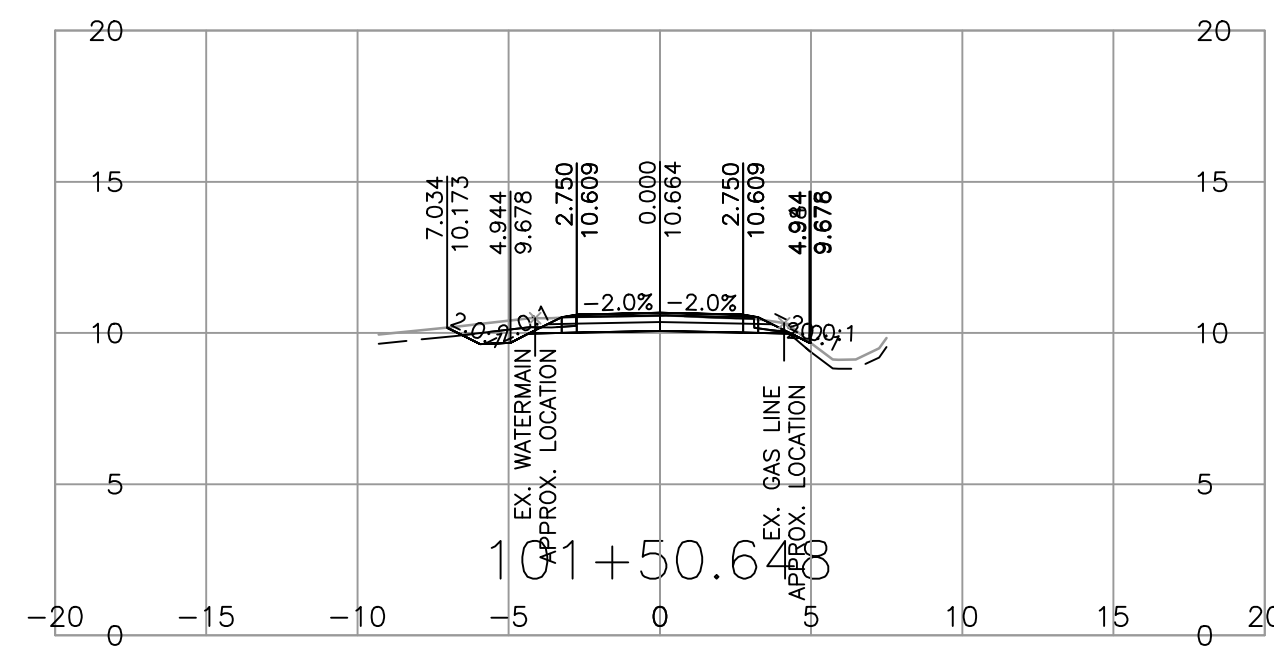
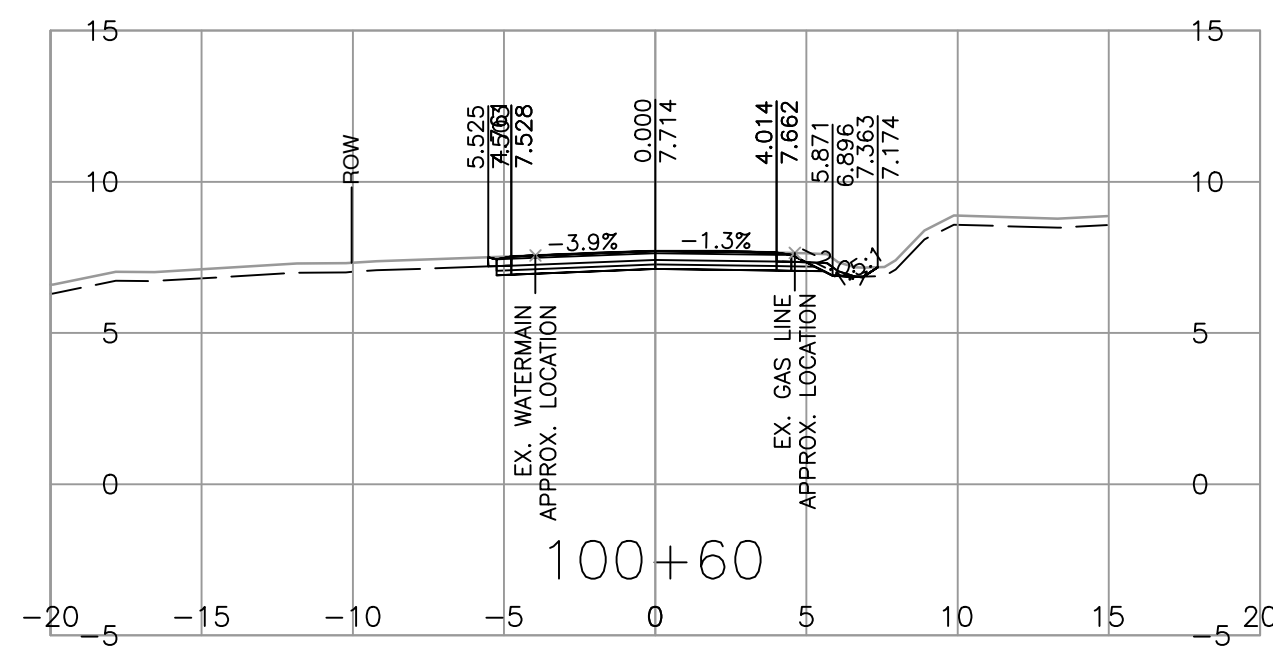
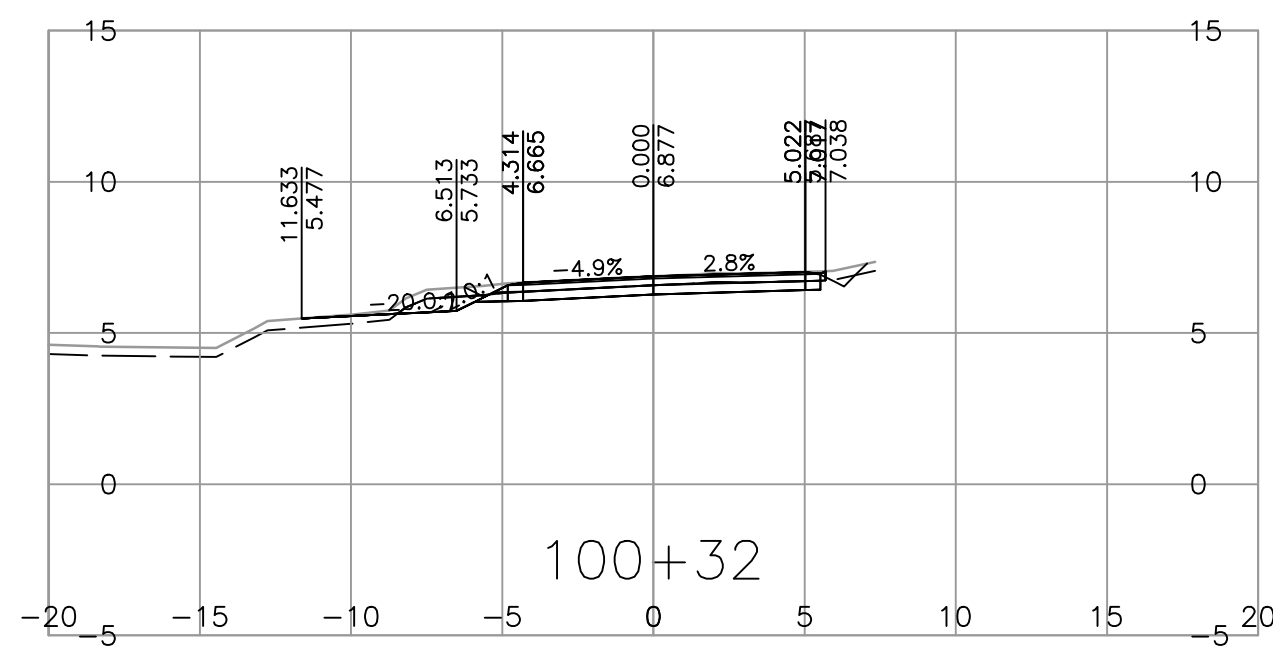
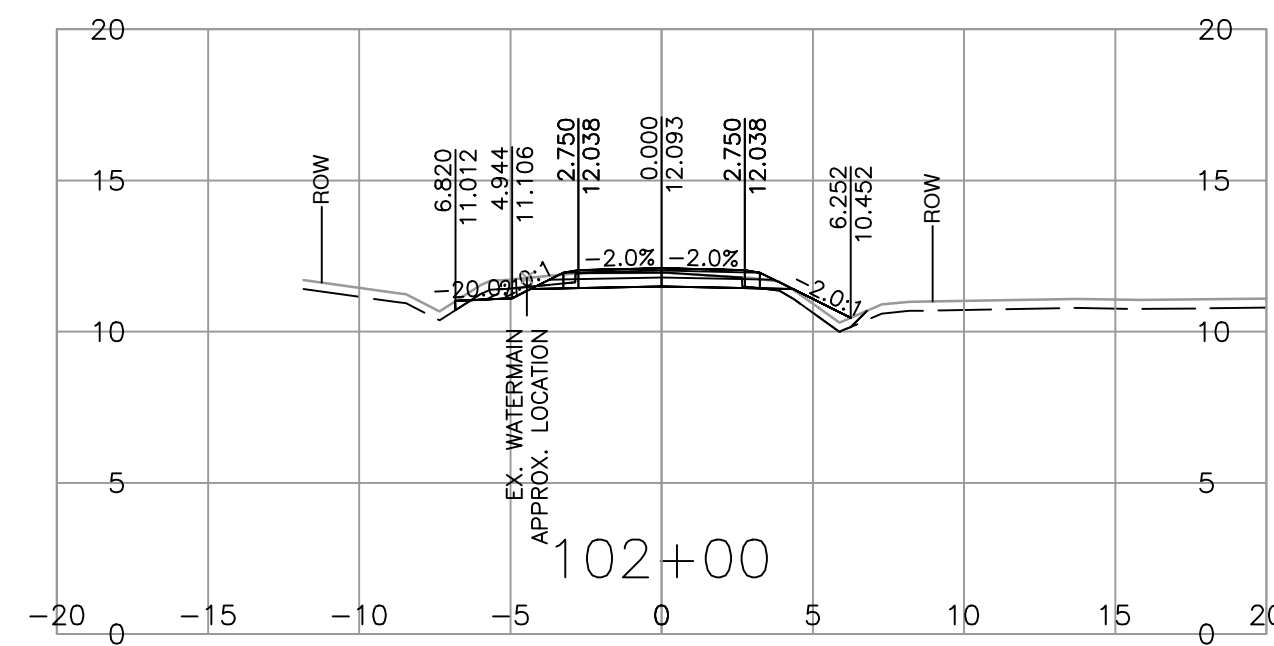
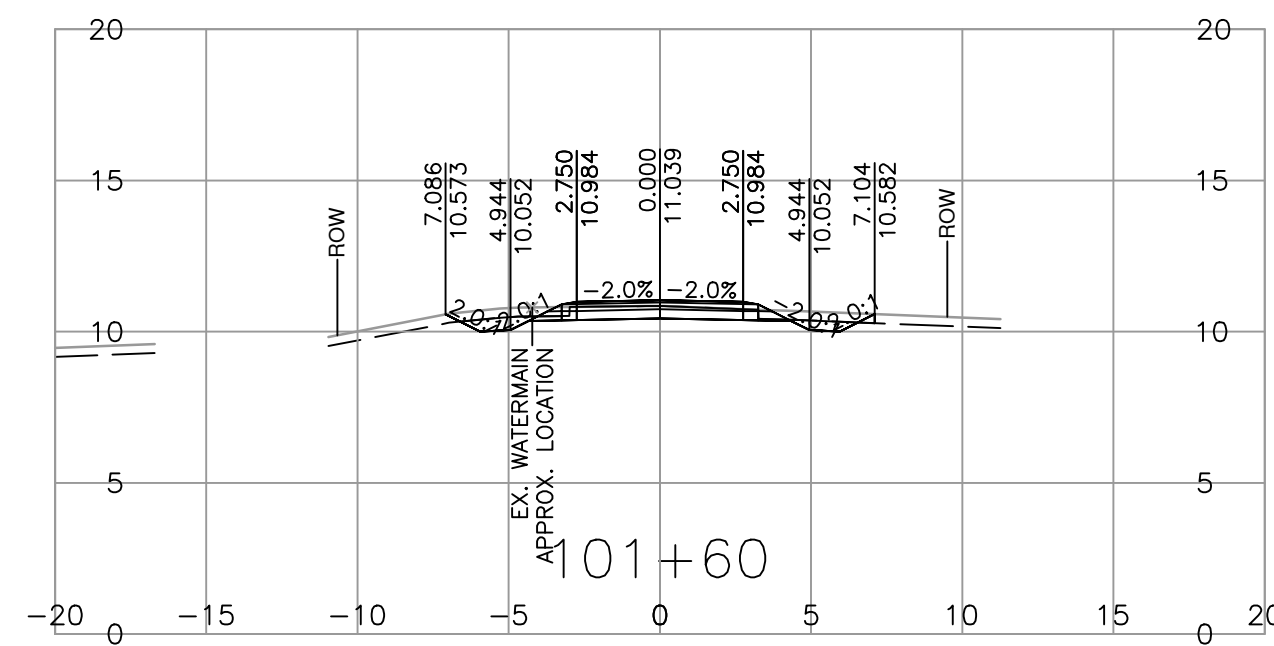
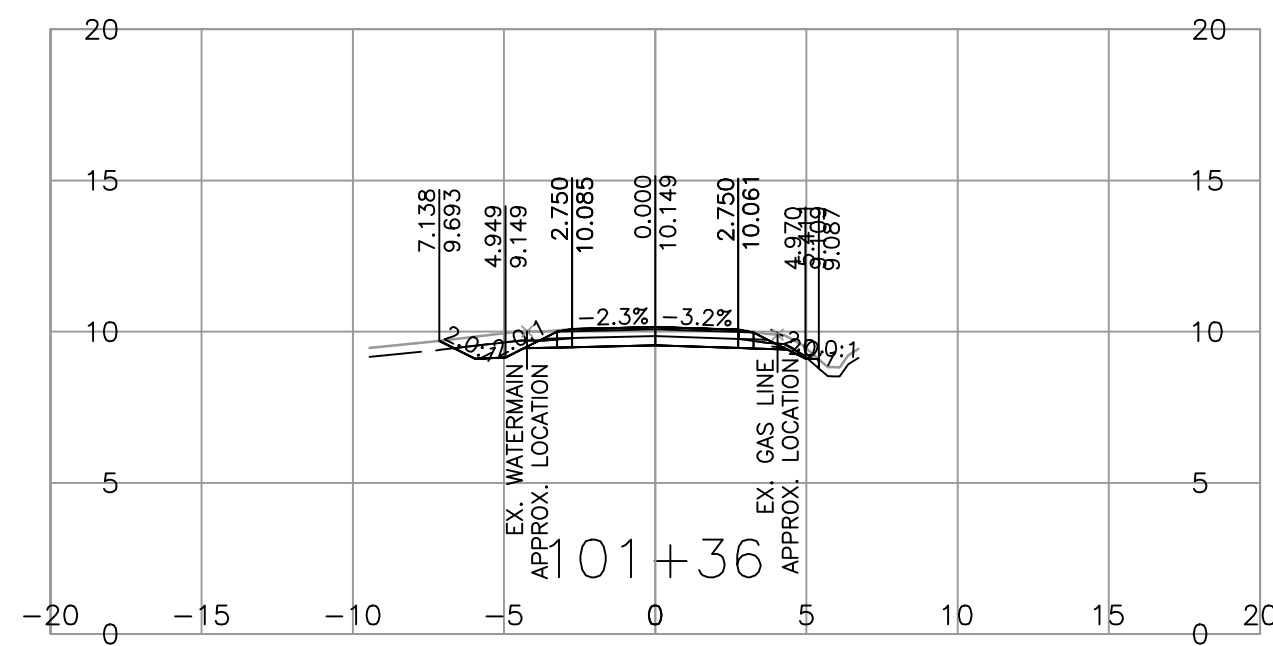
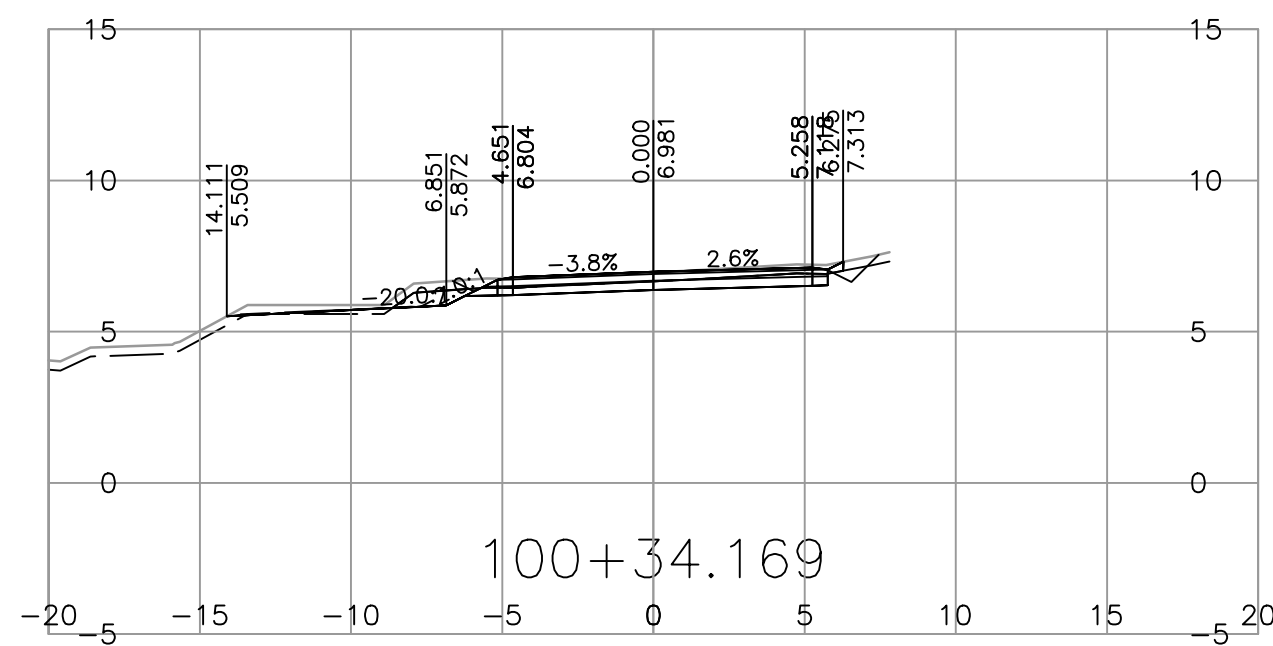
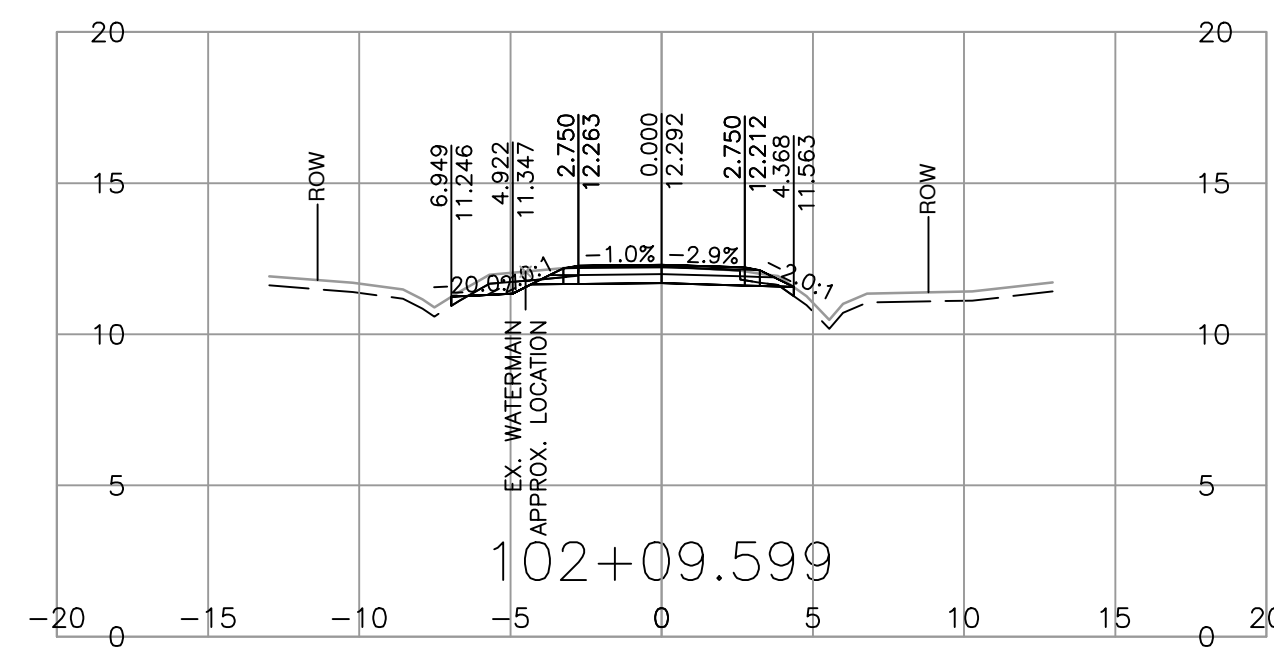
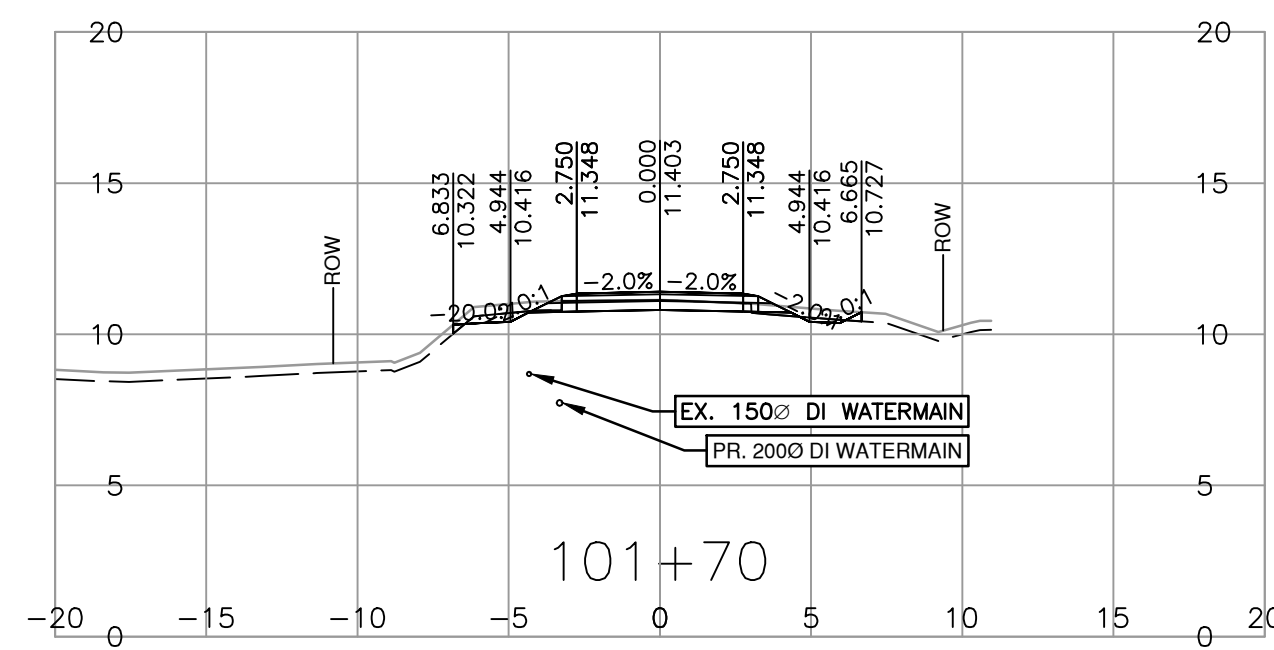
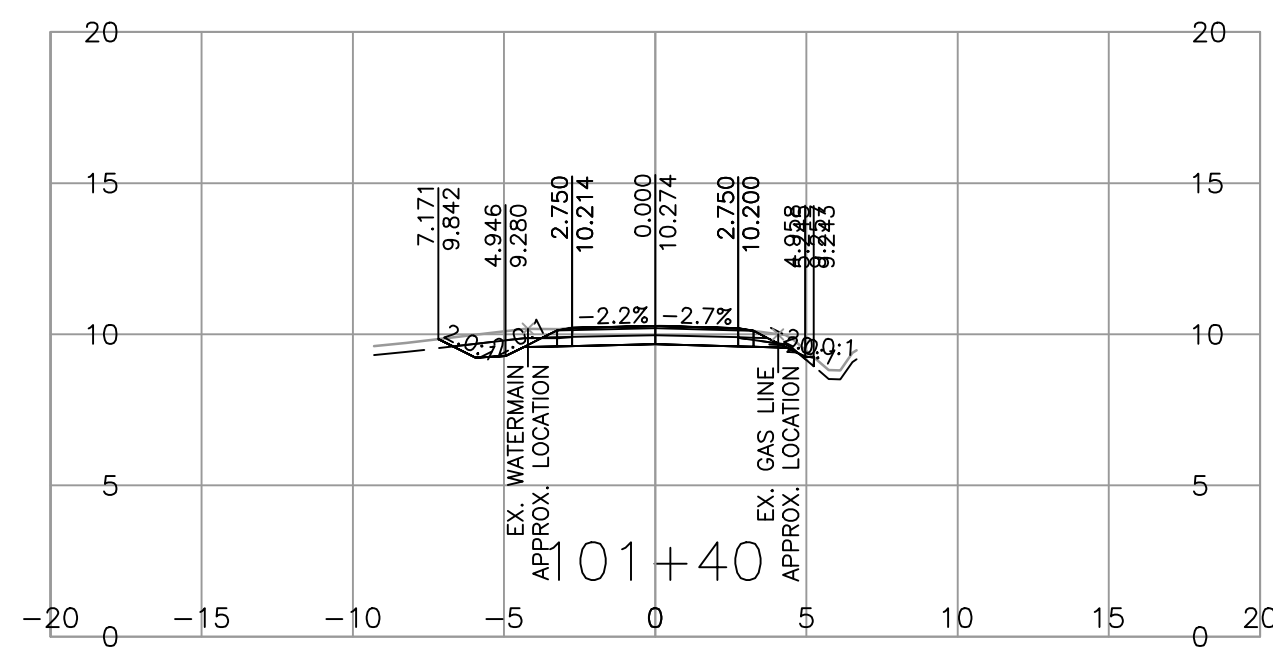
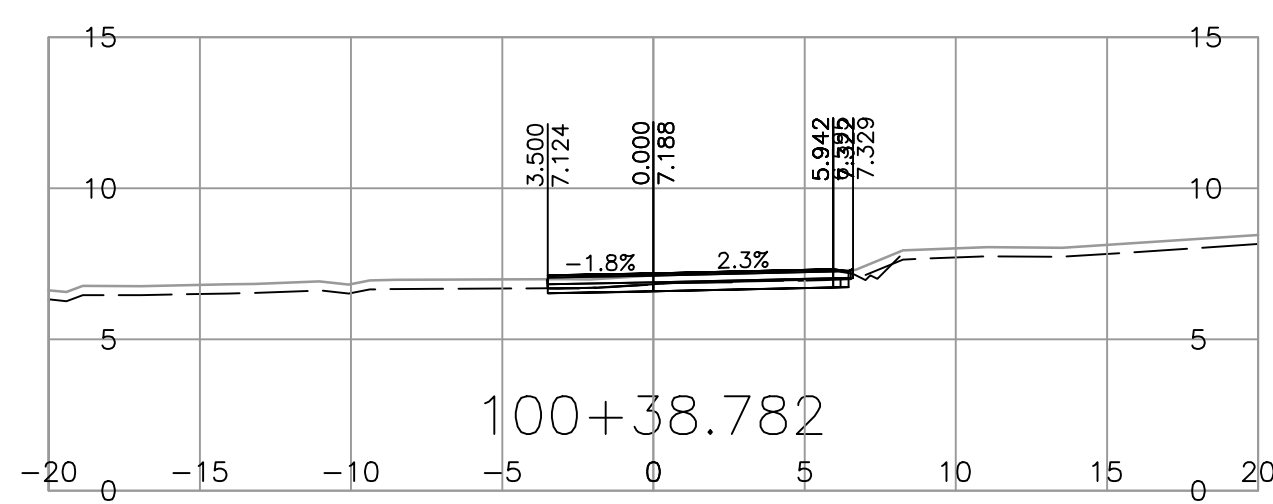
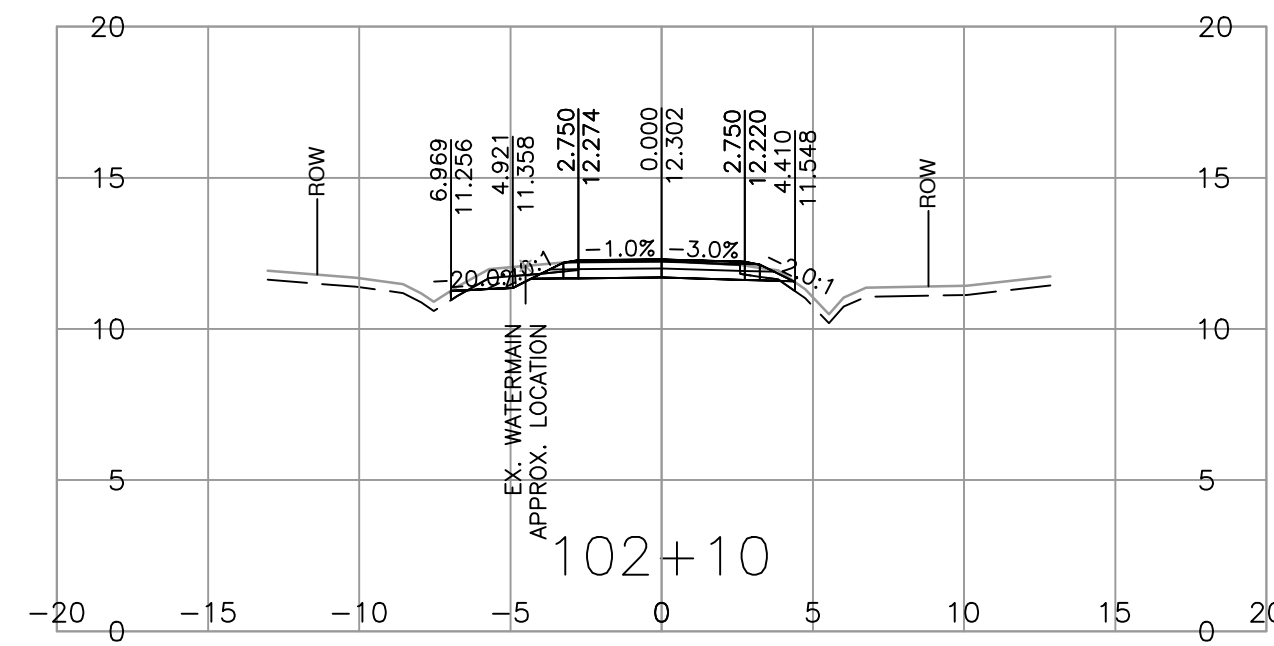
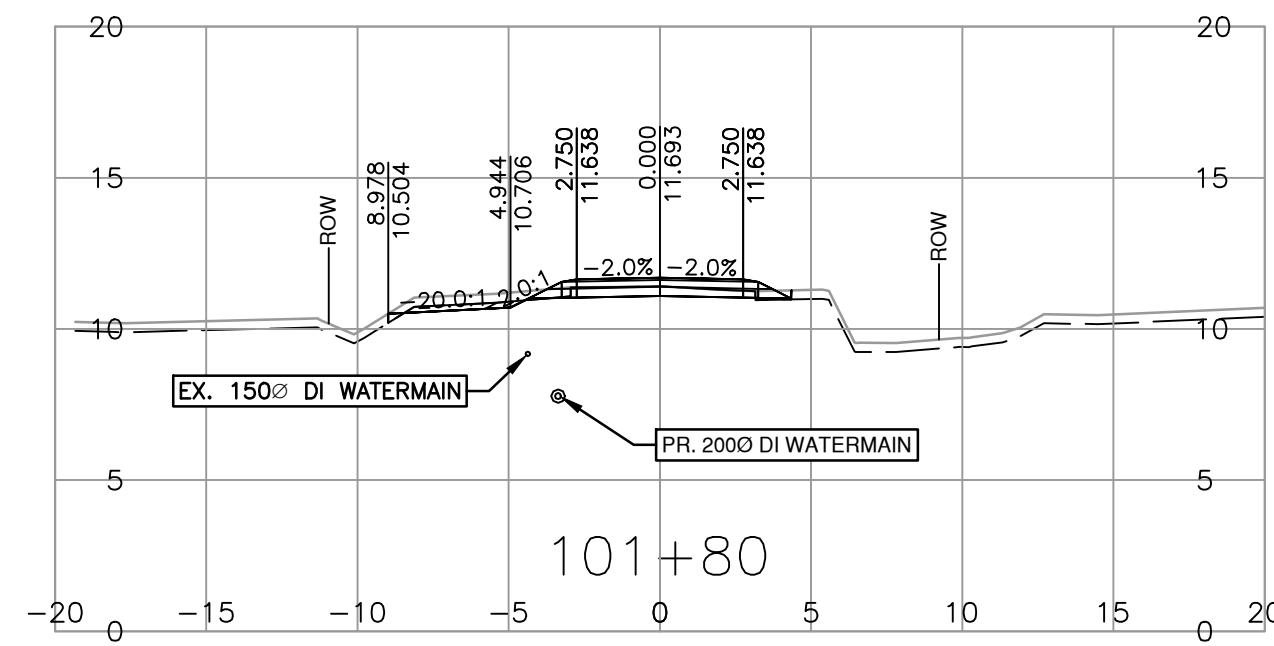
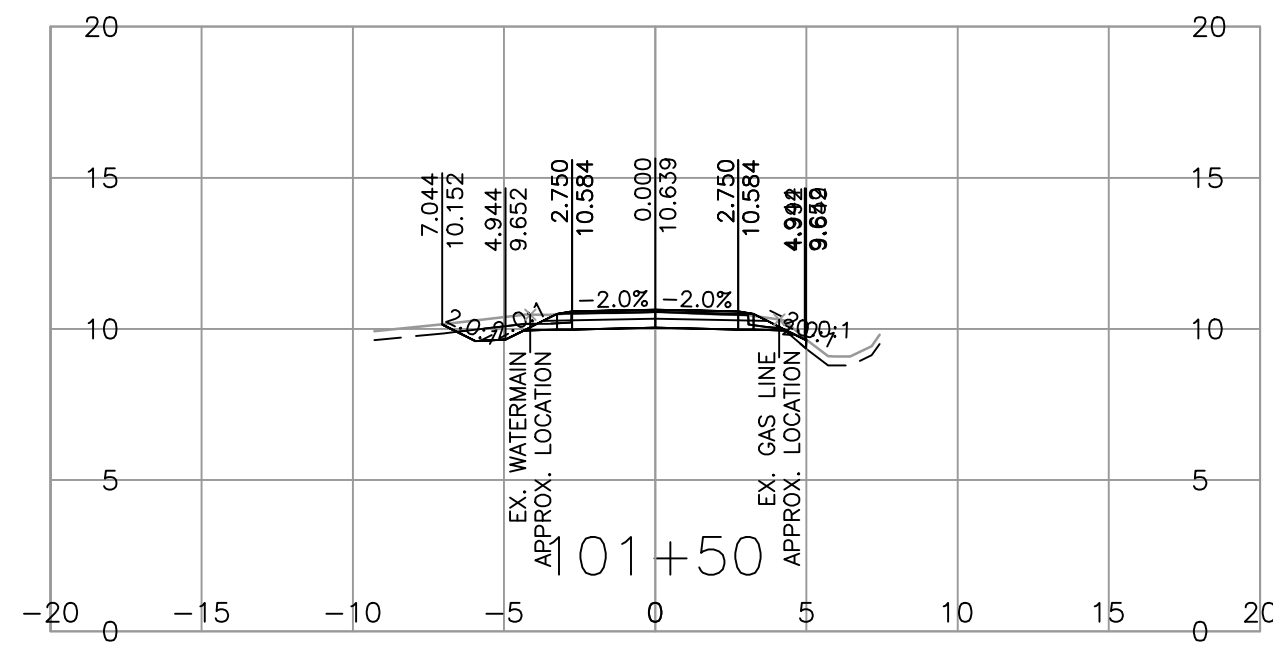
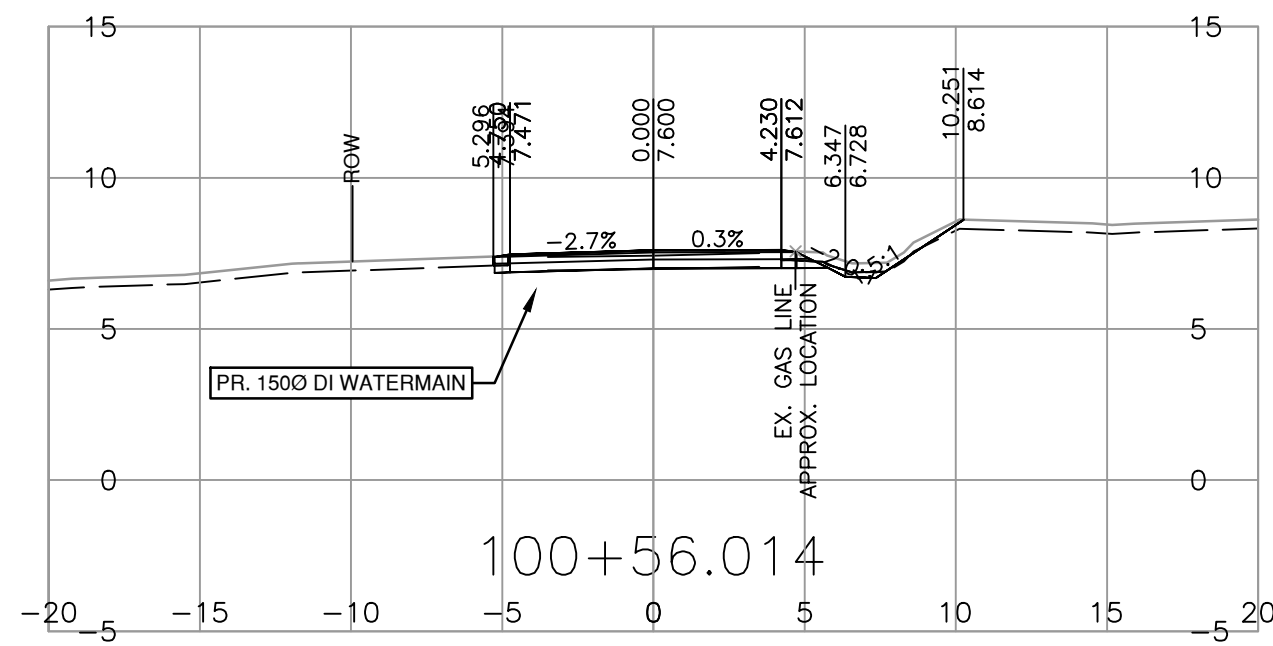

ISSUED FOR
100% DESIGN
2024-01-26
urbansystems.ca



SCALE 0 2 1:250 12m

CAD FILENAME R1-1027-1000
PLOT DATE 2024-01-26



BRITISH COLUMBIA

MINISTRY OF TRANSPORTATION AND INFRASTRUCTURE
SOUTH COAST REGION
HIGHWAY ENGINEERING AND GEOMATICS



REV	DATE	REVISIONS	NAME
A	2017-07-01		

SENIOR DESIGNER
DATE 2024-01-26

DESIGNED	S.CAVASINNI	DATE	2024-01-26
QUALITY CONTROL	E.PROULX	DATE	2024-01-26
QUALITY ASSURANCE	C.BAGG	DATE	2024-01-26
DRAWN	S.CAVASINNI	DATE	2024-01-26

L100 CROSS SECTIONS
PART A - FLUME CREEK
DFAA FLOOD DAMAGE

FILE NUMBER	PROJECT NUMBER	REG	DRAWING NUMBER	REV
872CS1714	14005	1	R1-1027-1000	

PLOT DATE: 2024/01/25 U:\Projects_SUR\1961\0480\14\0-Design\CAD\DrawingProduction\1000_DesignSections\R1-1027-1000.dwg

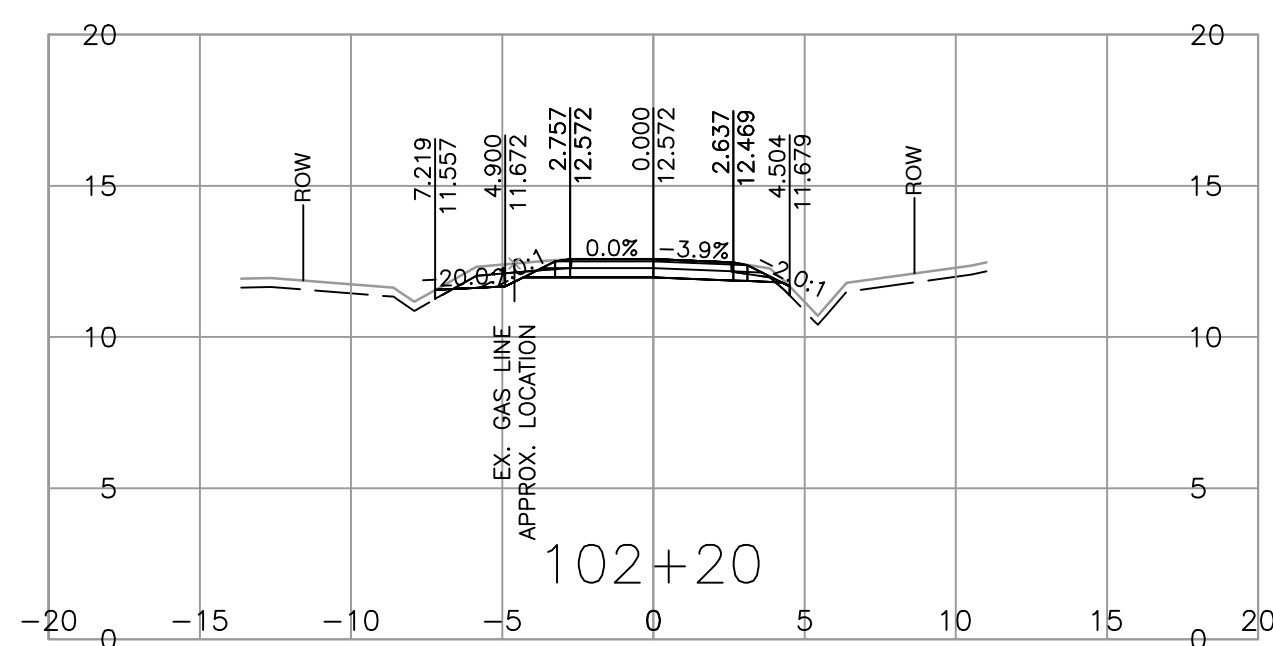
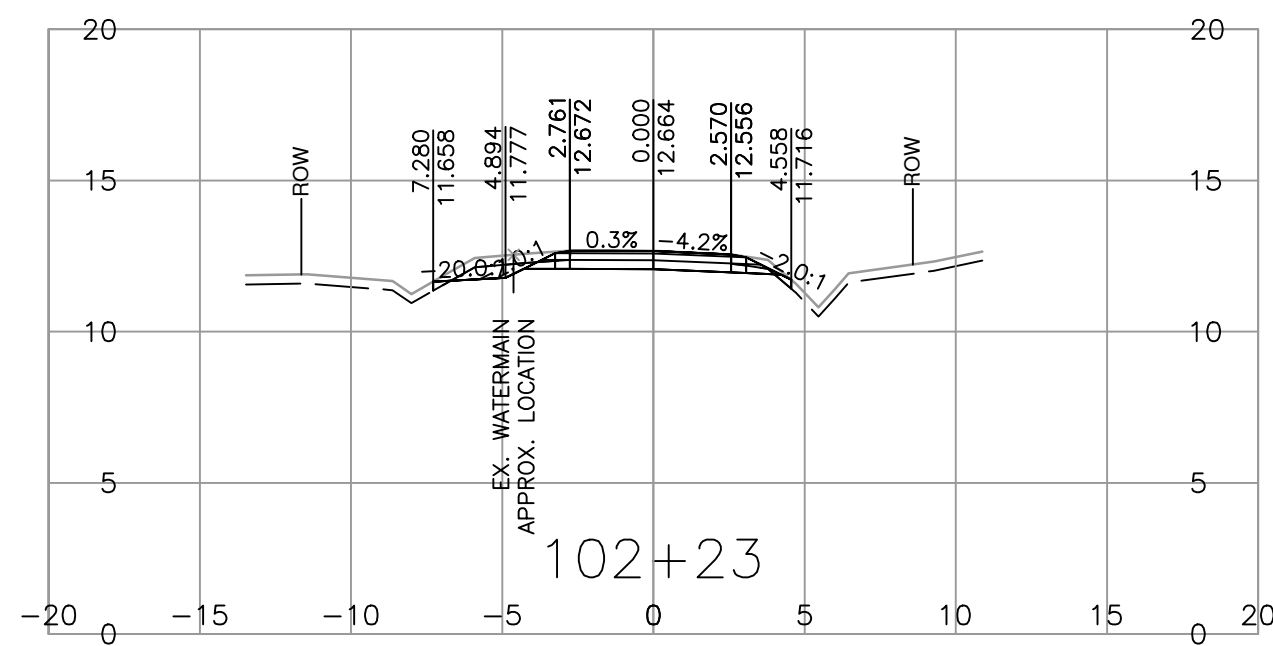

ISSUED FOR
100% DESIGN
2024-01-26
urbansystems.ca



SCALE 0 2 1:250 12m		CAD FILENAME R1-1027-1000	
		PLOT DATE 2024-01-26	
REV	DATE	REVISIONS	NAME
A	2017-07-01		



BRITISH COLUMBIA
 MINISTRY OF TRANSPORTATION AND INFRASTRUCTURE
 SOUTH COAST REGION
 HIGHWAY ENGINEERING AND GEOMATICS

DESIGNED S.CAVASINI	DATE 2024-01-26
QUALITY CONTROL E.PROULX	DATE 2024-01-26
QUALITY ASSURANCE C.BAGG	DATE 2024-01-26
DRAWN S.CAVASINI	DATE 2024-01-26

SENIOR DESIGNER _____
DATE 2024-01-26

L100 CROSS SECTIONS			
PART A - FLUME CREEK DFAA FLOOD DAMAGE			
FILE NUMBER 872CS1714	PROJECT NUMBER 14005	REG 1	DRAWING NUMBER R1-1027-1000

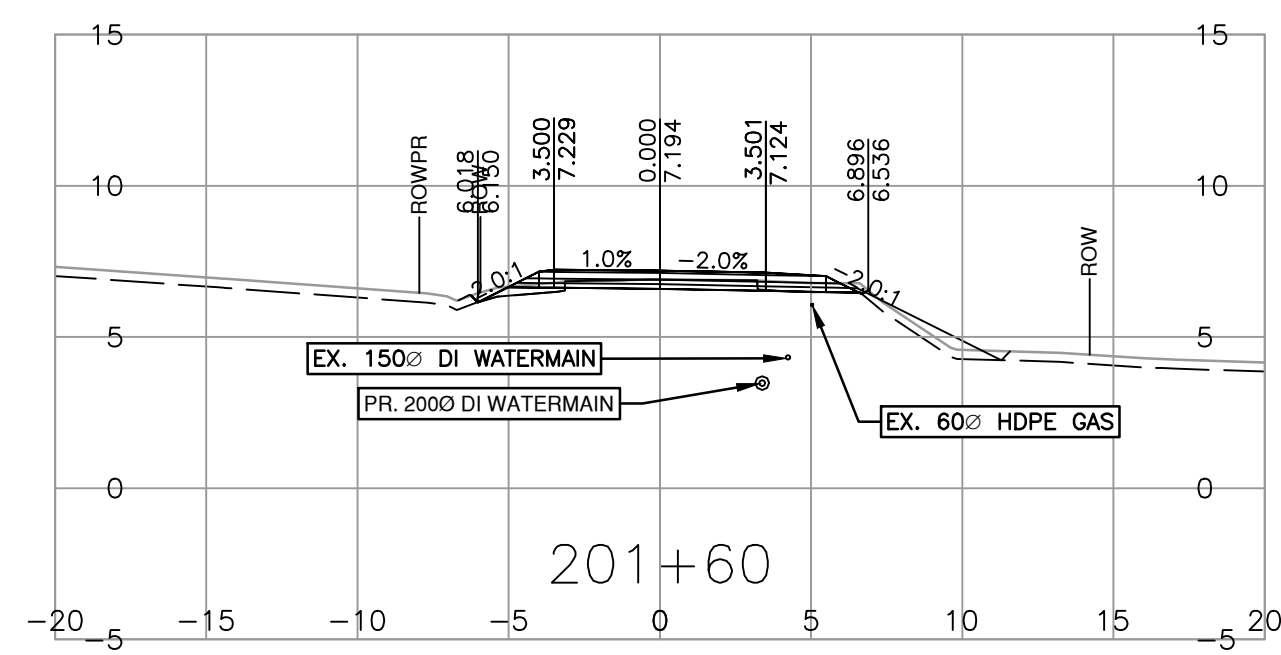
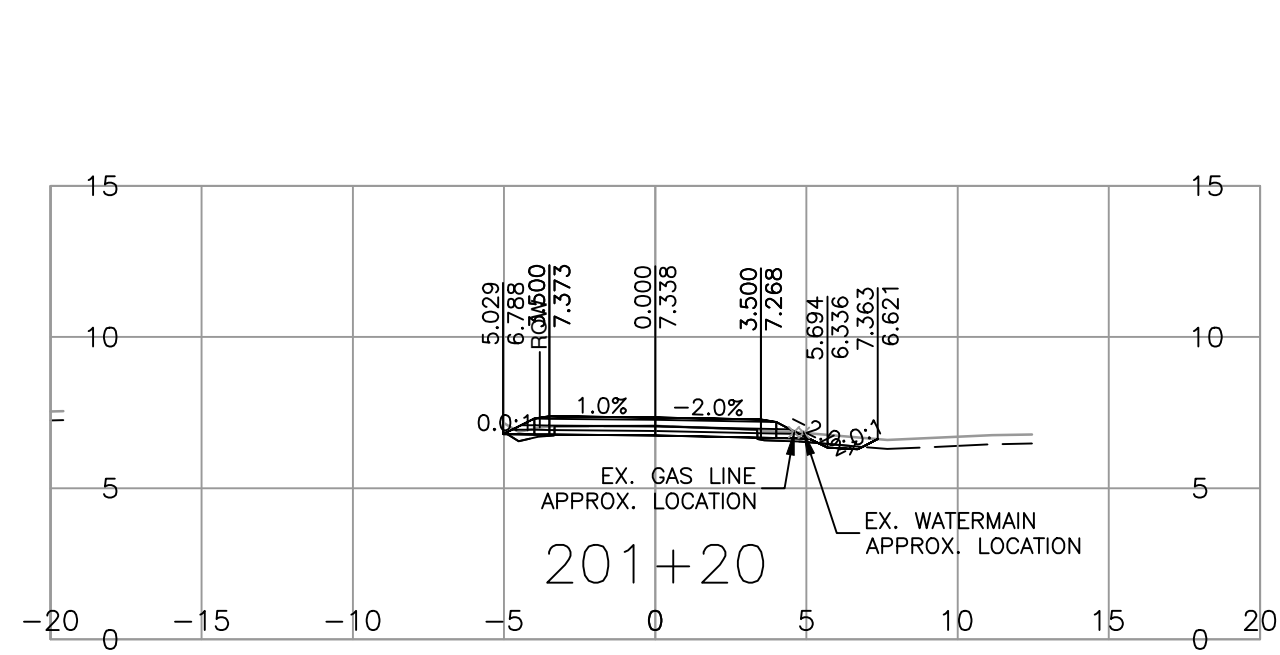
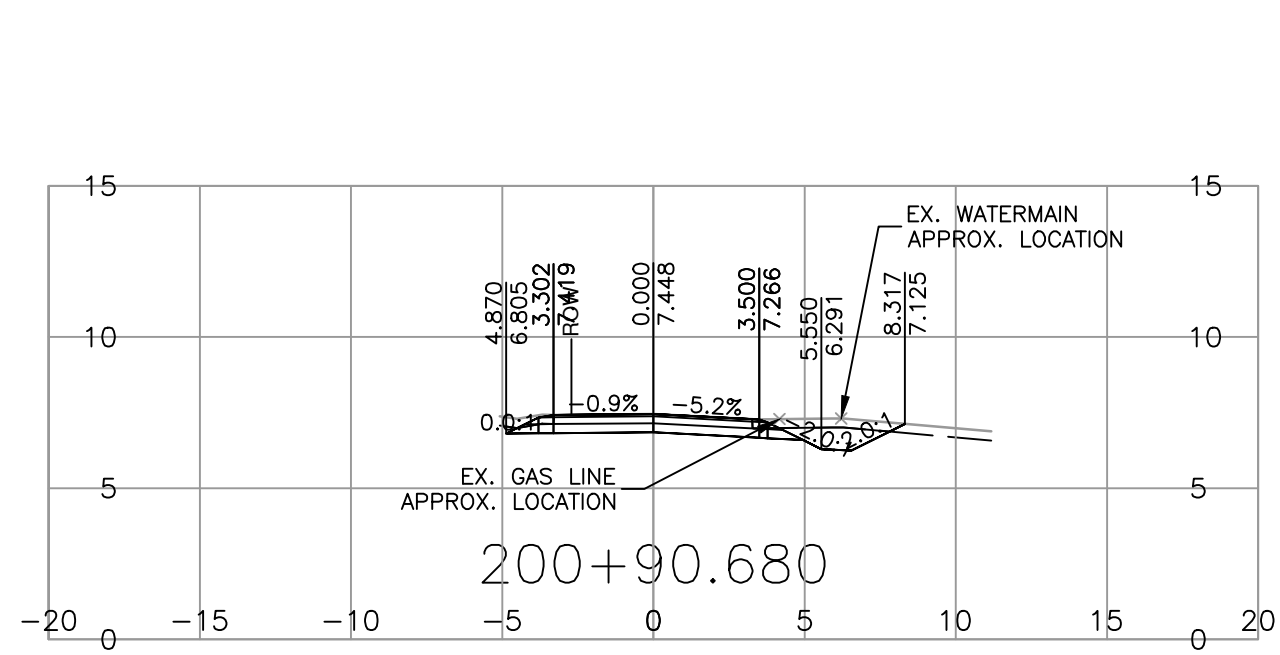
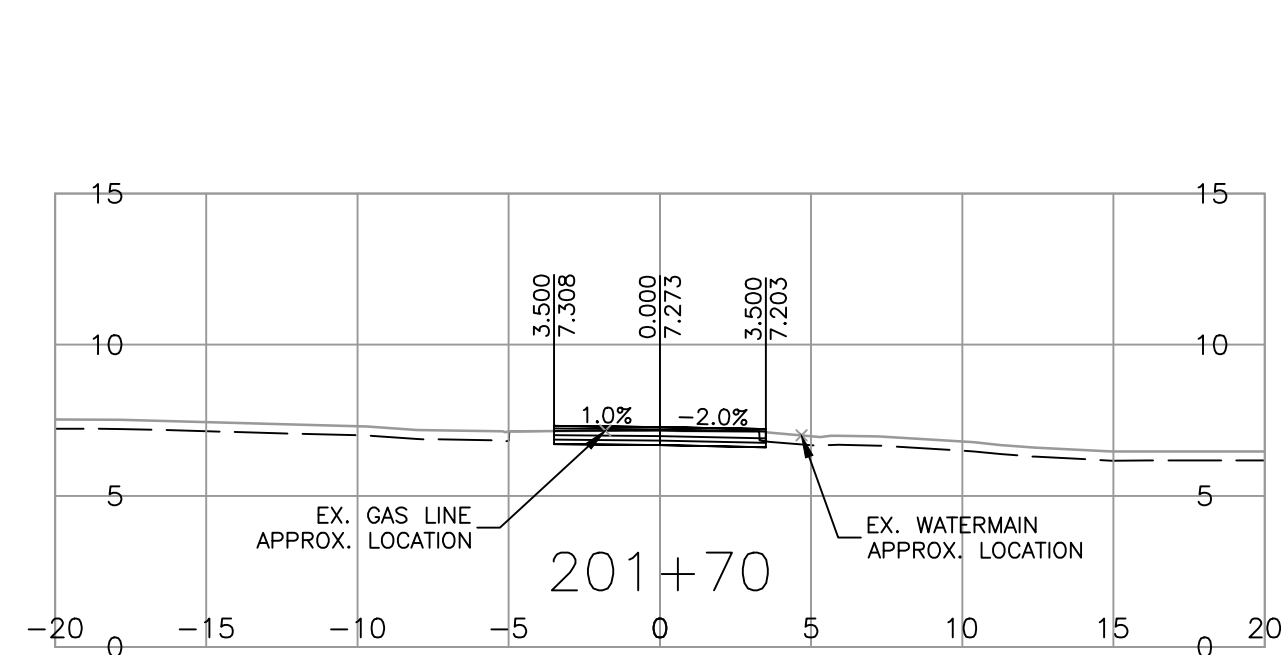
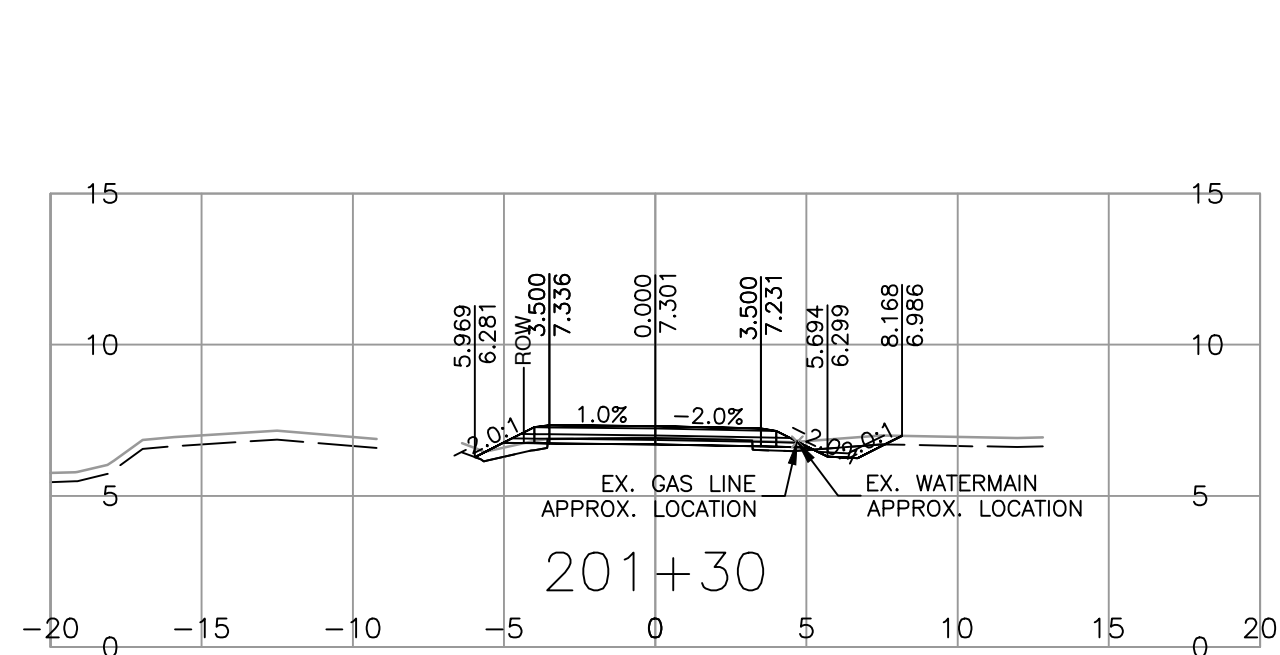
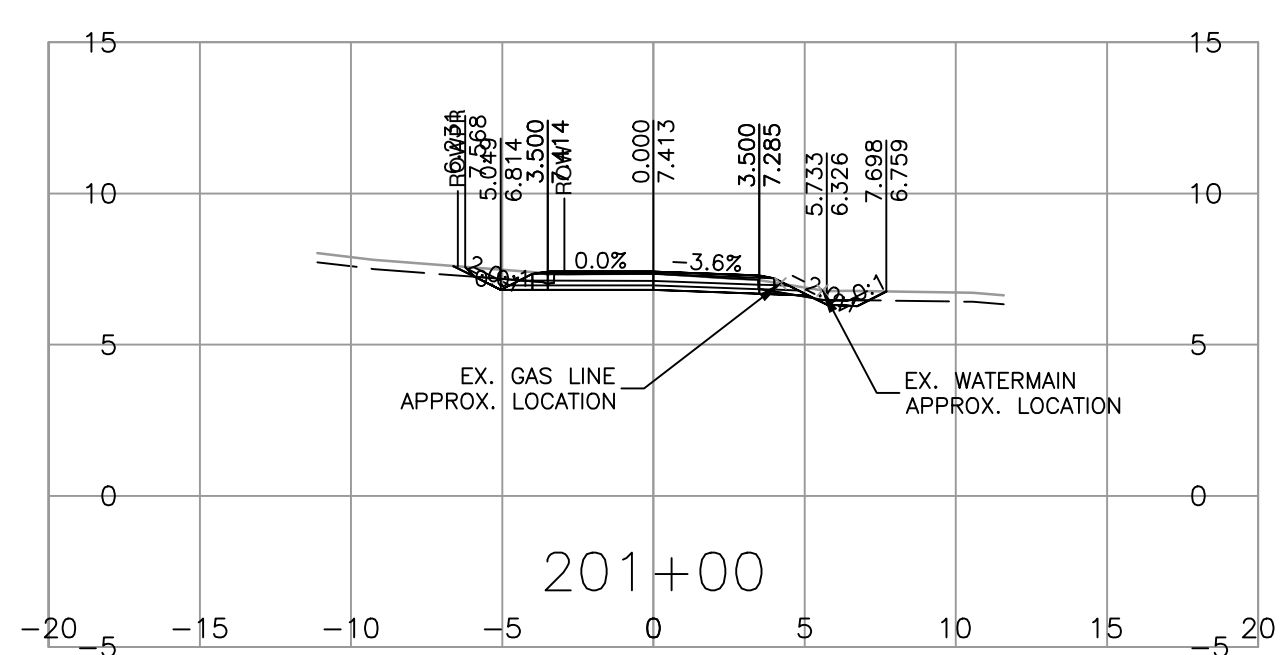
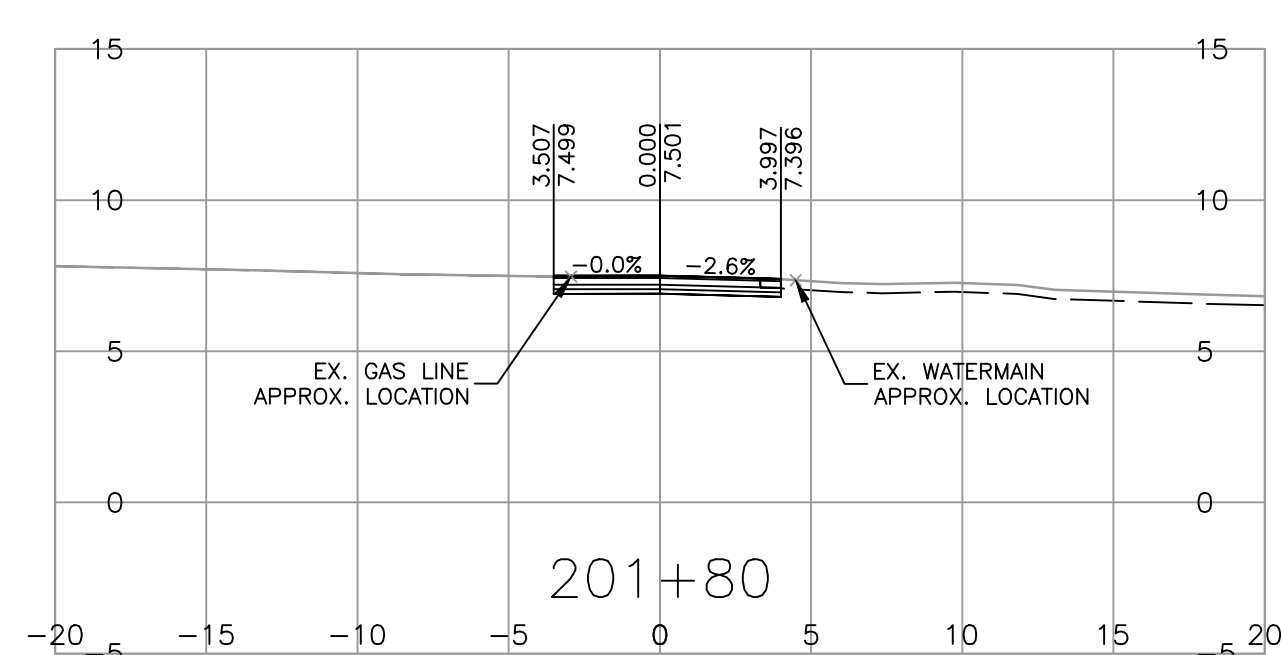
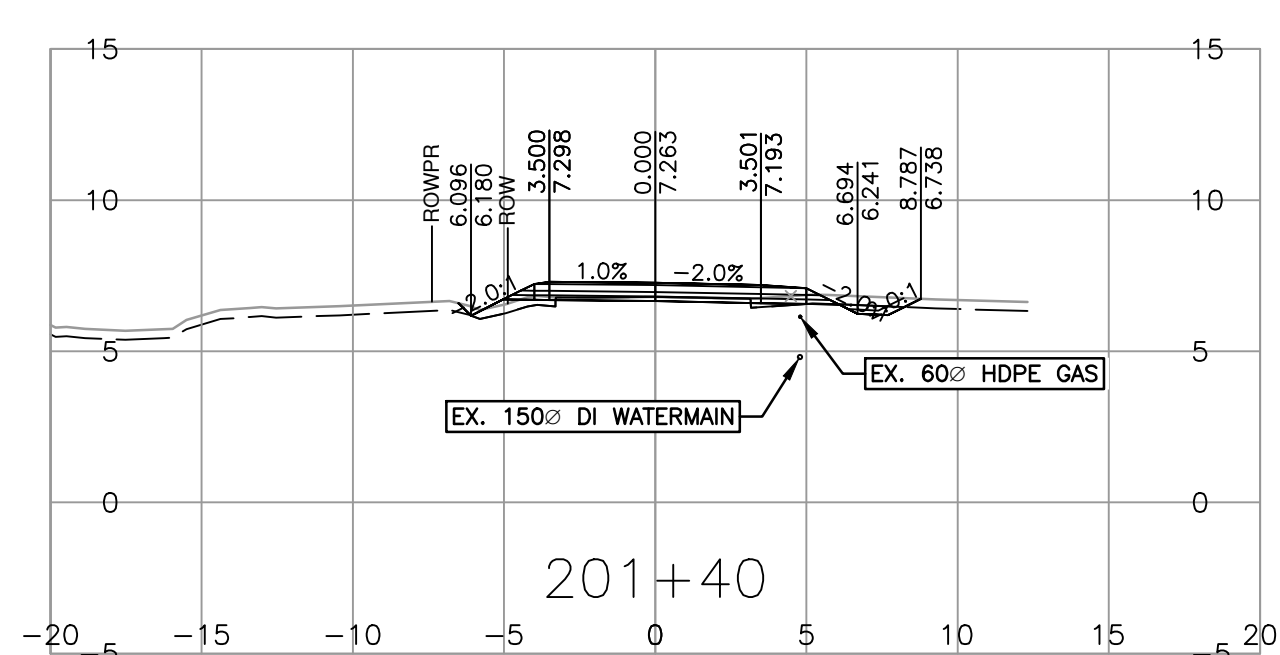
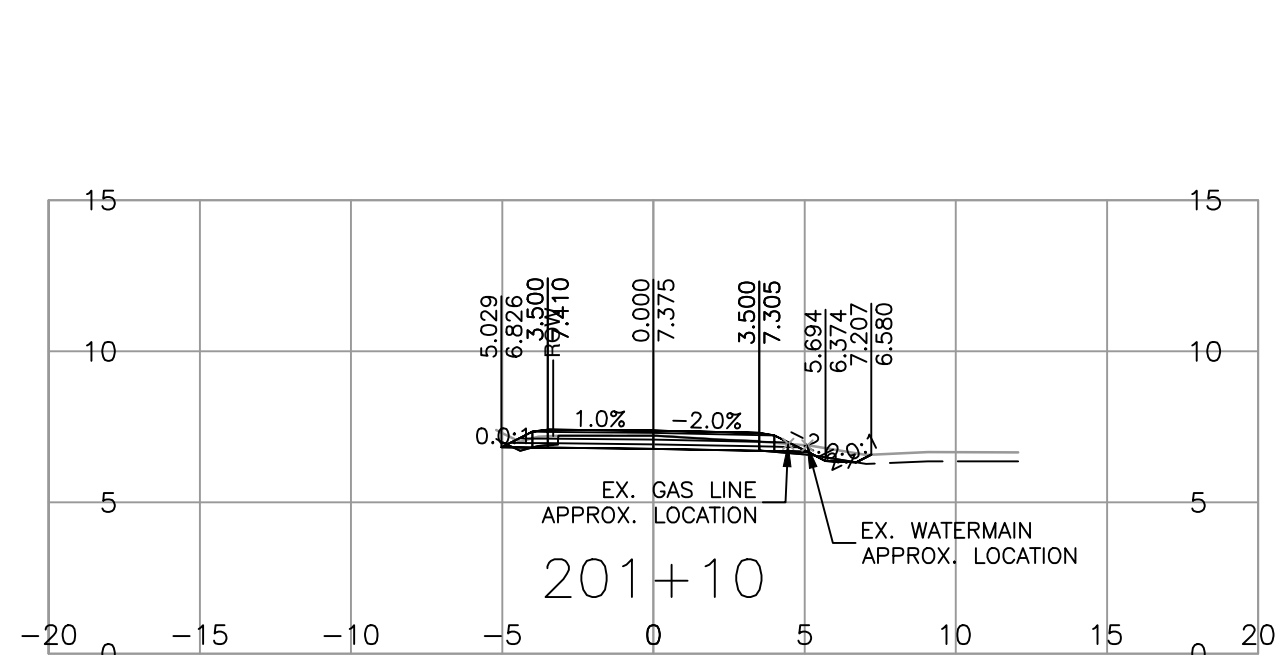
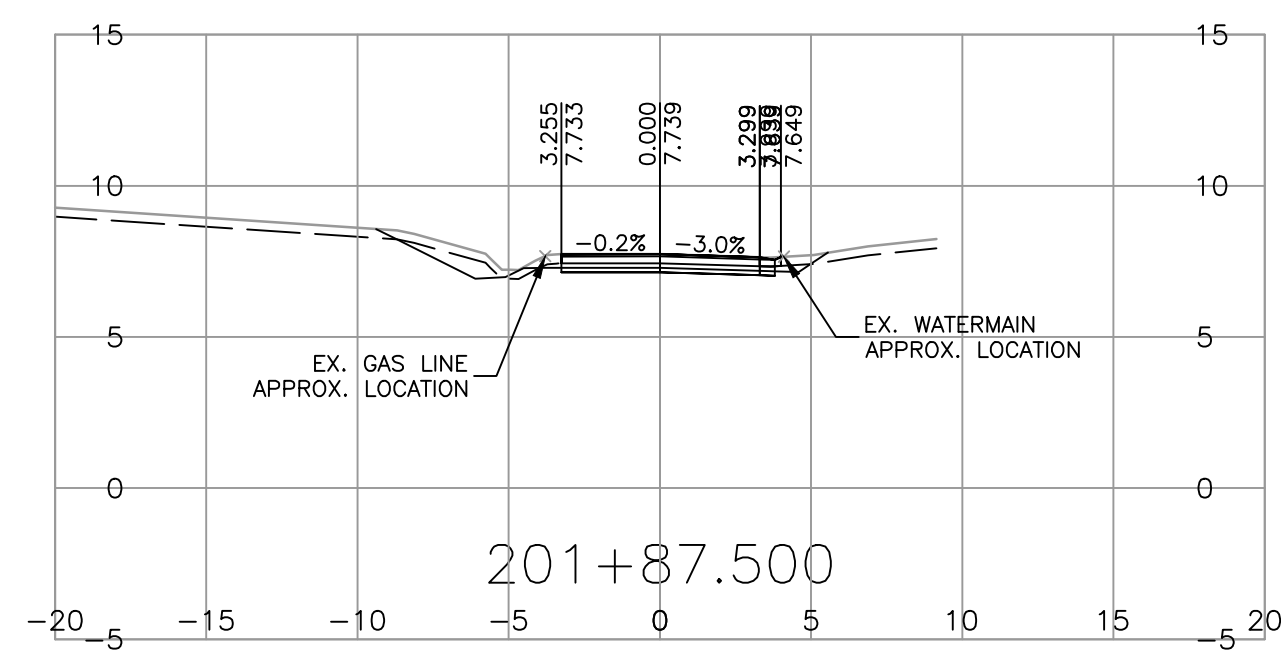
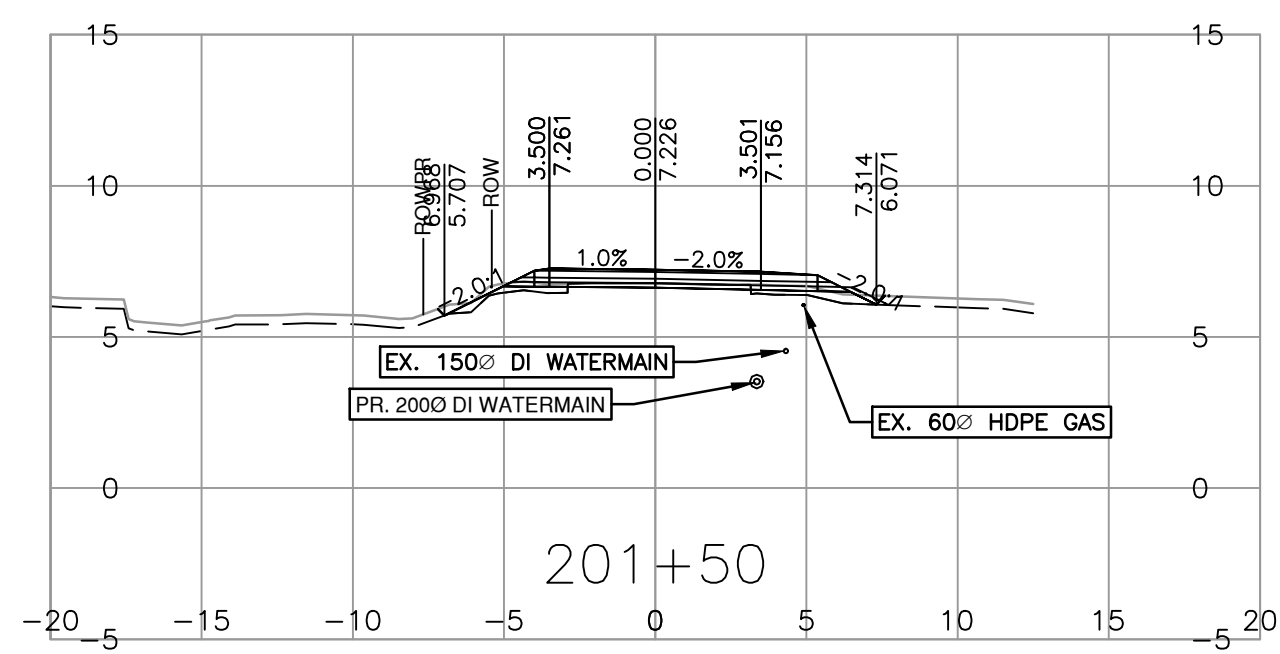
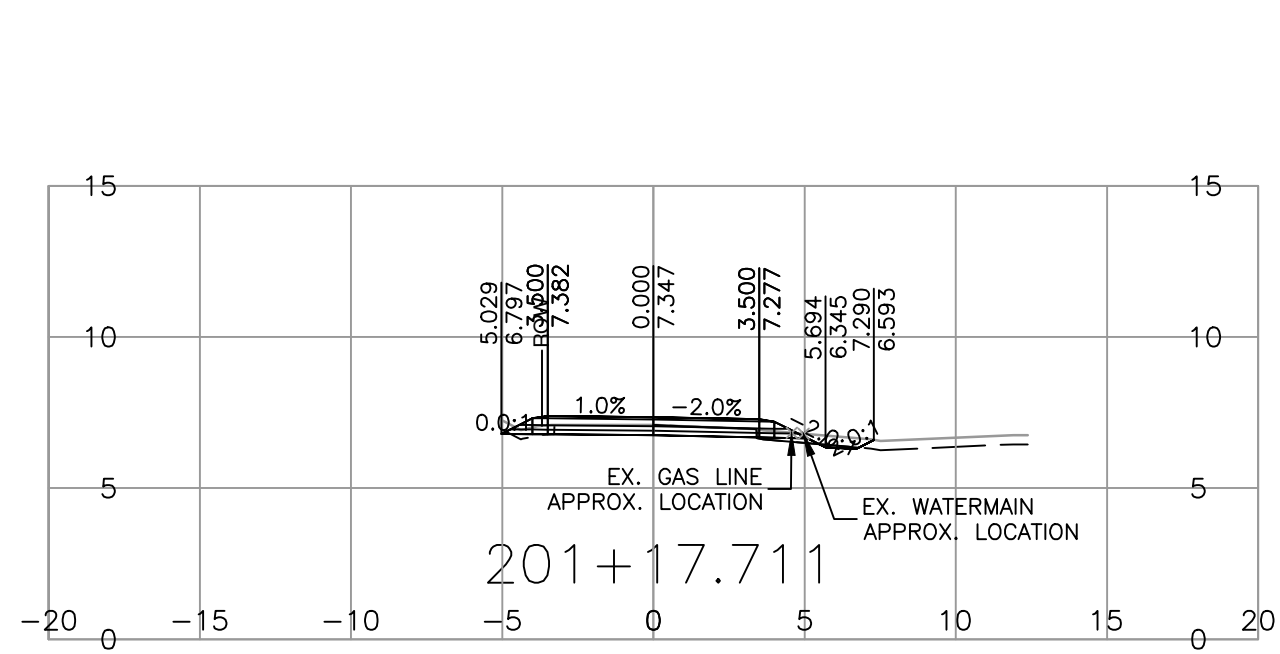
PLOT DATE: 2024/01/25 U:\Projects_SUR\1961\0480\14\0-Design\CAD\DrawingProduction\1000_DesignSections\R1-1027-1000.dwg



ISSUED FOR
100% DESIGN
2024-01-26
urbansystems.ca



SCALE 0 2 1:250 12m

CAD FILENAME R1-1027-1000
PLOT DATE 2024-01-26

REV	DATE	REVISIONS	NAME
A	2017-07-01		

BRITISH COLUMBIA MINISTRY OF TRANSPORTATION AND INFRASTRUCTURE
SOUTH COAST REGION
HIGHWAY ENGINEERING AND GEOMATICS

DESIGNED S.CAVASINNI DATE 2024-01-26
QUALITY CONTROL E.PROULX DATE 2024-01-26
QUALITY ASSURANCE C.BAGG DATE 2024-01-26
DRAWN S.CAVASINNI DATE 2024-01-26

SENIOR DESIGNER _____
DATE 2024-01-26

L200 CROSS SECTIONS
PART A - FLUME CREEK
DFAA FLOOD DAMAGE

FILE NUMBER	PROJECT NUMBER	REG	DRAWING NUMBER	REV
872CS1714	14005	1	R1-1027-1000	

PLOT DATE: 2024/01/25 U:\Projects_SUR\1961\0480\14\0-Design\CAD\DrawingProduction\1000_DesignSections\R1-1027-1000.dwg

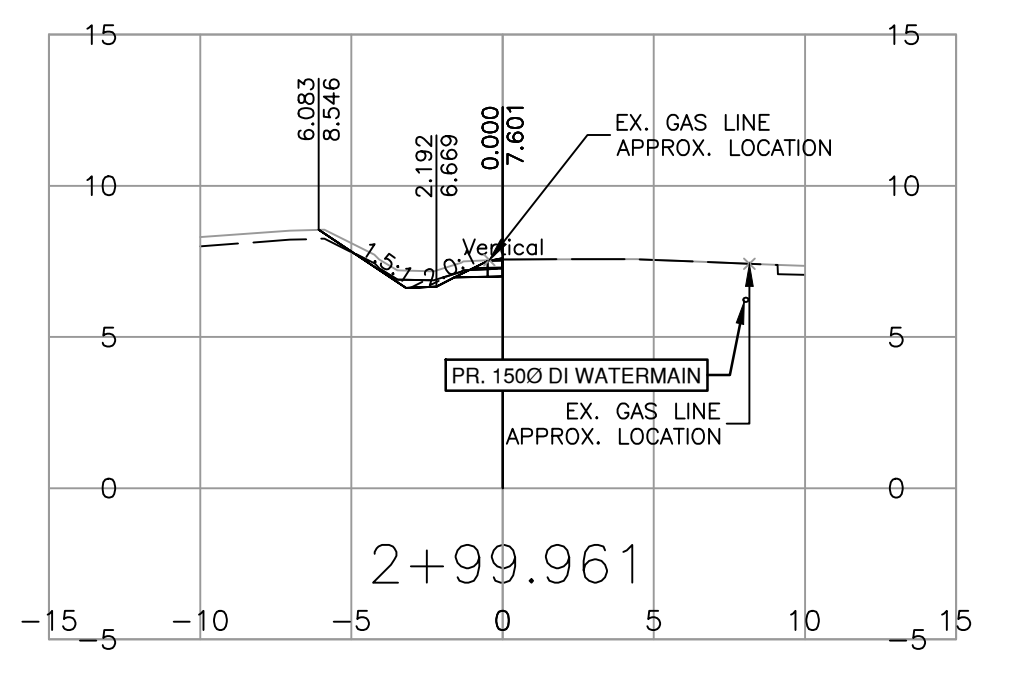
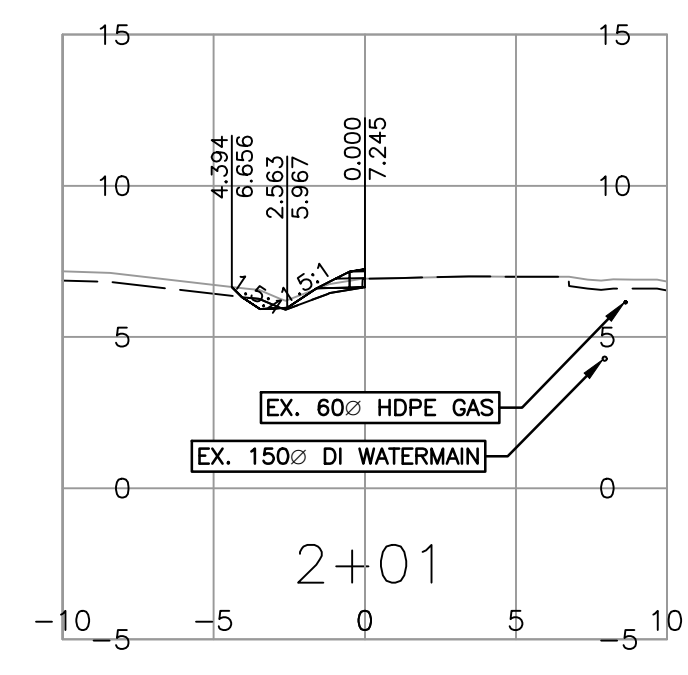
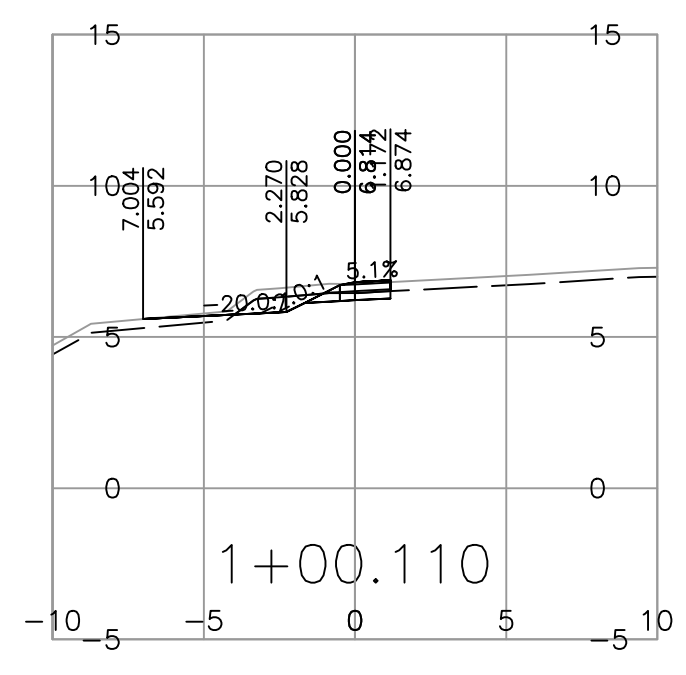
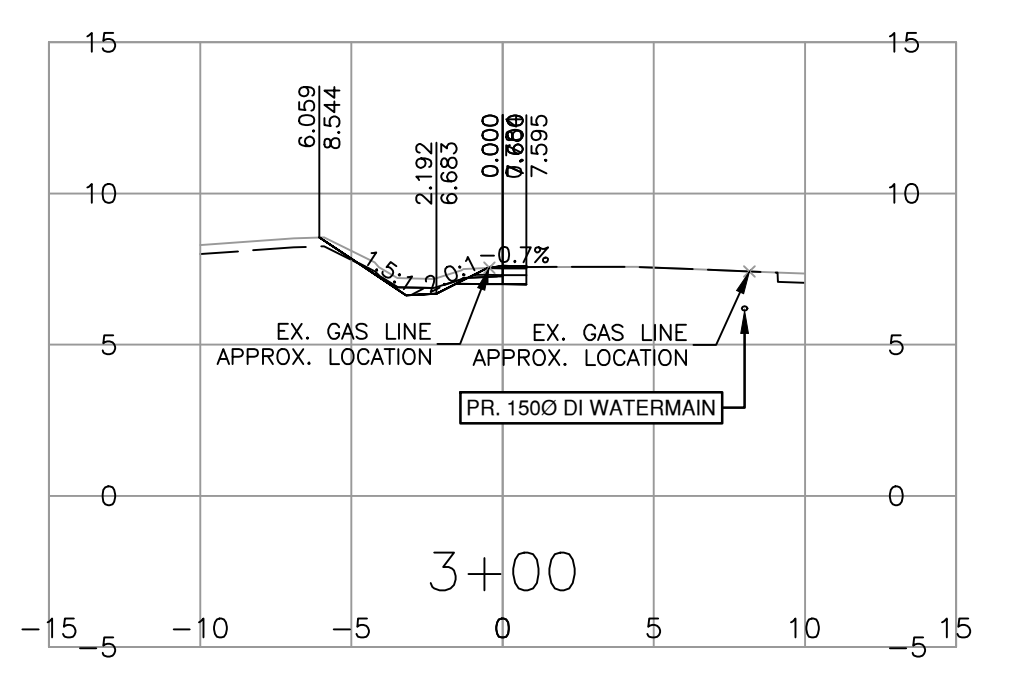
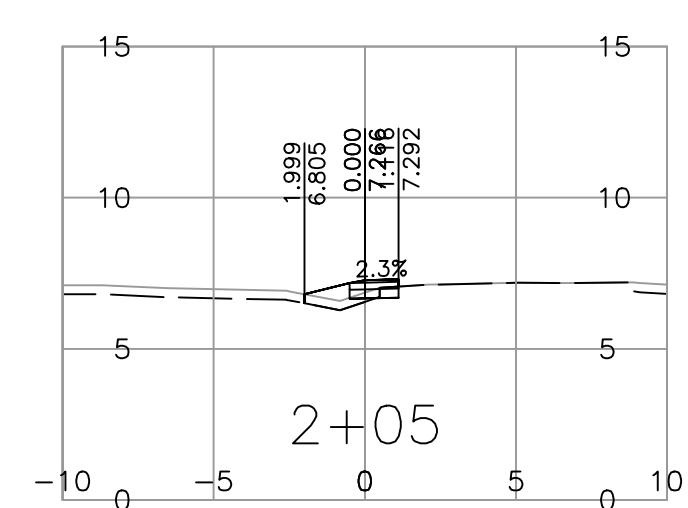
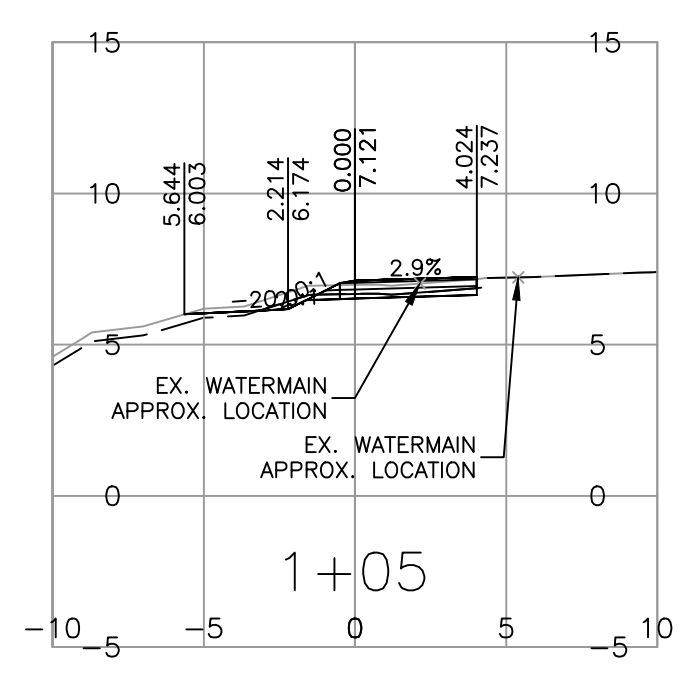
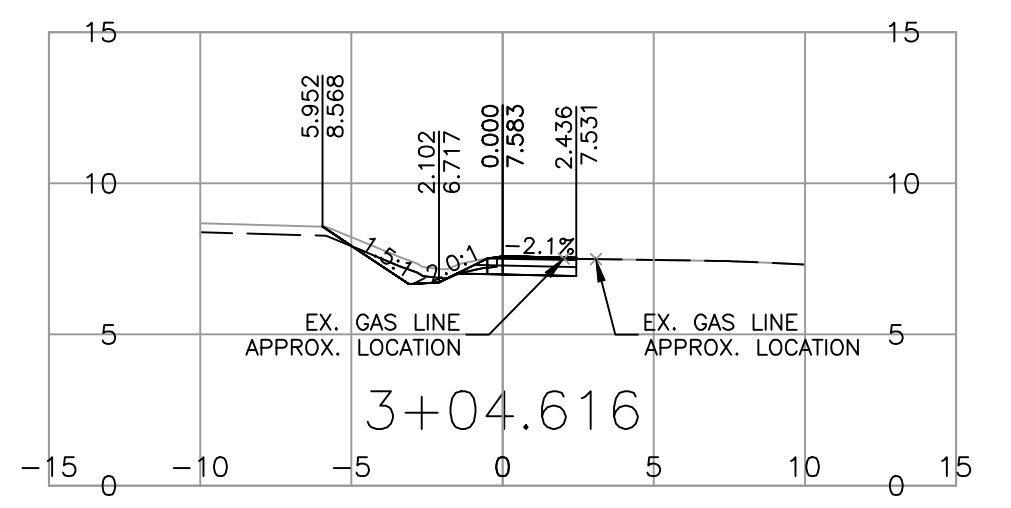
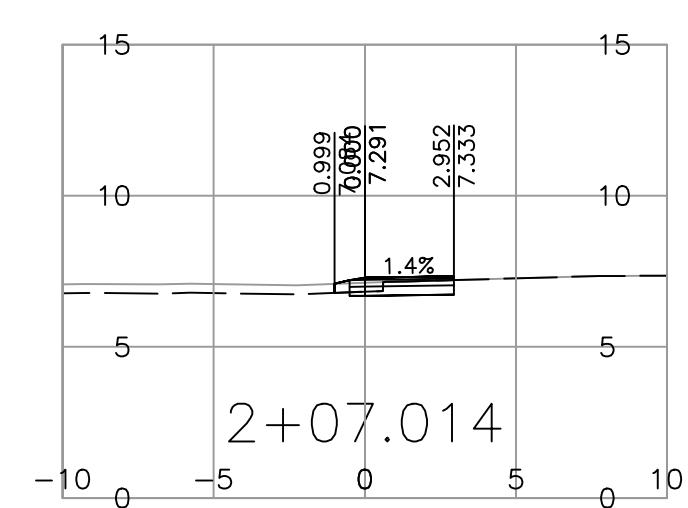
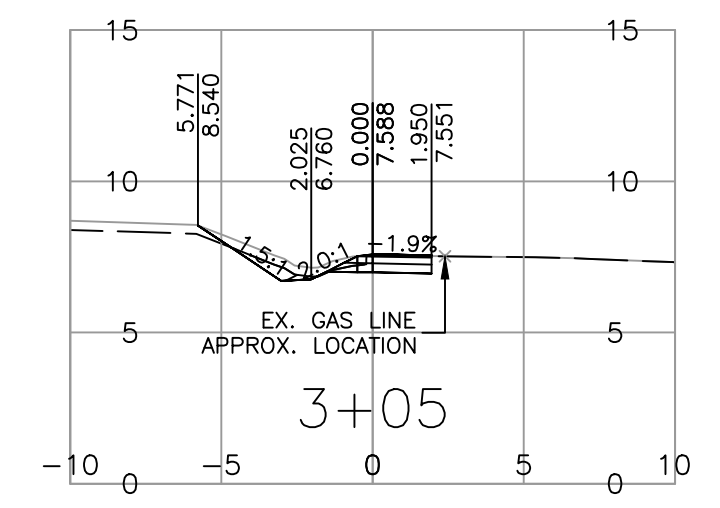
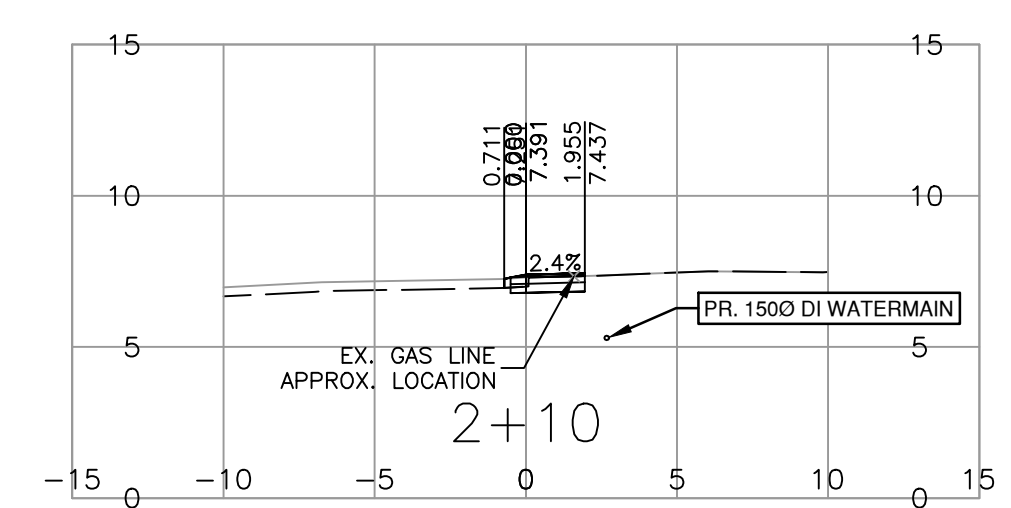
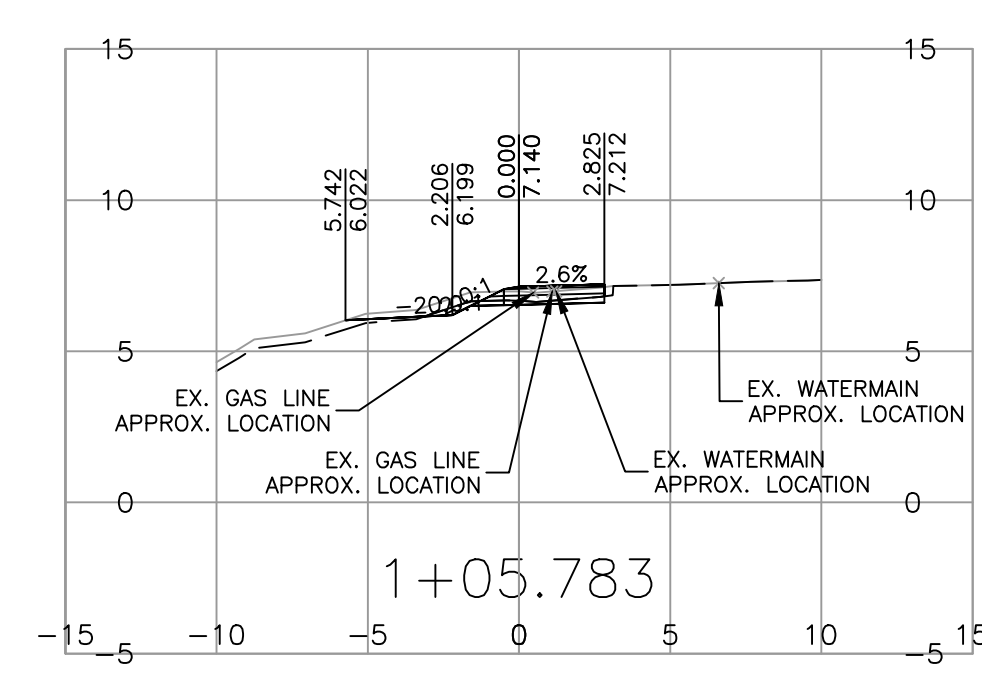
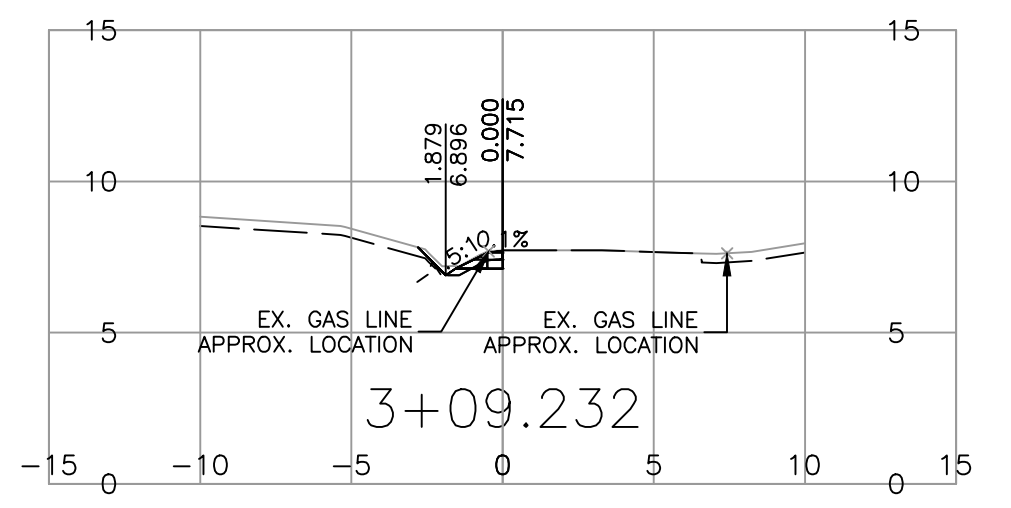
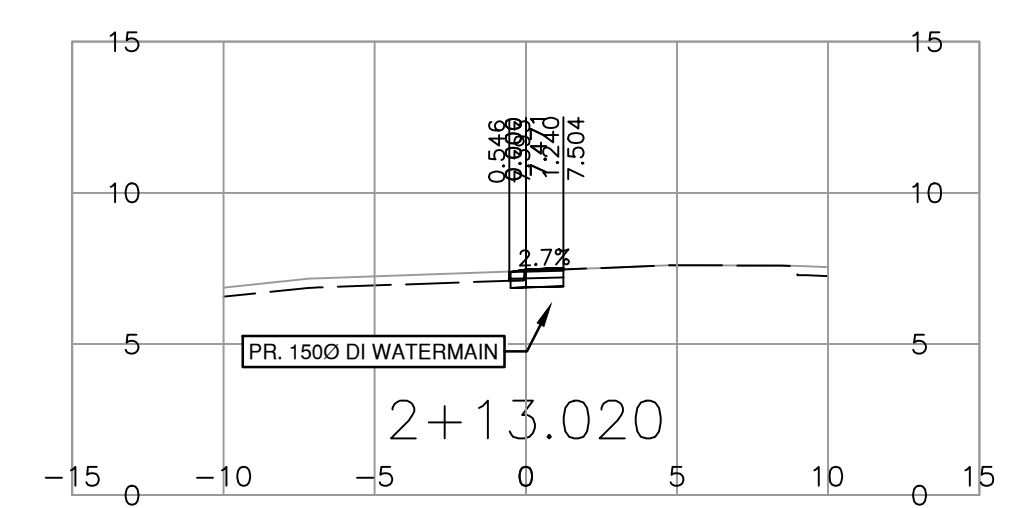
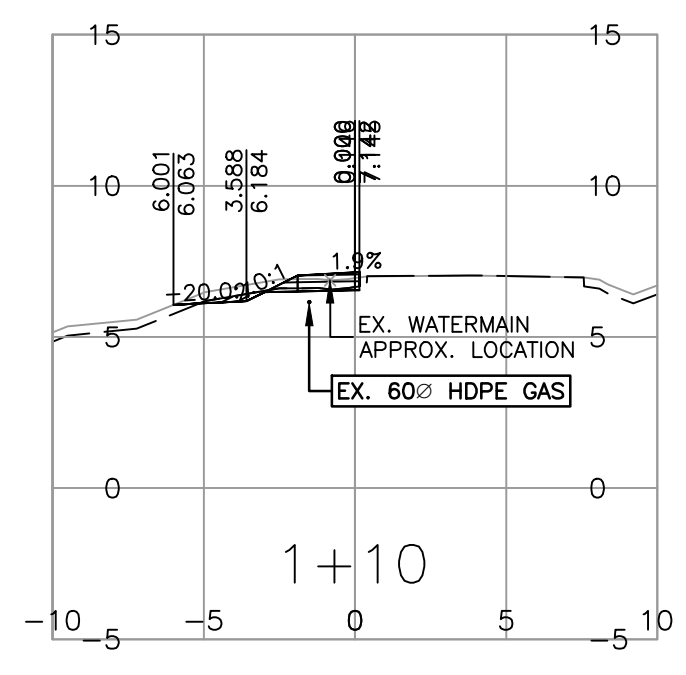

ISSUED FOR
100% DESIGN
2024-01-26
urbansystems.ca



SCALE 0 2 1:250 12m

CAD FILENAME R1-1027-1000
PLOT DATE 2024-01-26

REV	DATE	REVISIONS	NAME
A	2017-07-01		

BRITISH COLUMBIA
MINISTRY OF TRANSPORTATION AND INFRASTRUCTURE
SOUTH COAST REGION
HIGHWAY ENGINEERING AND GEOMATICS

DESIGNED S.CAVASINNI DATE 2024-01-26
QUALITY CONTROL E.PROULX DATE 2024-01-26
QUALITY ASSURANCE C.BAGG DATE 2024-01-26
DRAWN S.CAVASINNI DATE 2024-01-26

SENIOR DESIGNER _____
DATE 2024-01-26

C1, C2 AND C3 CROSS SECTIONS
PART A - FLUME CREEK
DFAA FLOOD DAMAGE

FILE NUMBER	PROJECT NUMBER	REG	DRAWING NUMBER	REV
872CS1714	14005	1	R1-1027-1000	

PLOT DATE: 2024/01/25 U:\Projects_SUR\1961\0480\14\0-Design\CAD\DrawingProduction\1000_DesignSections\R1-1027-1000.dwg

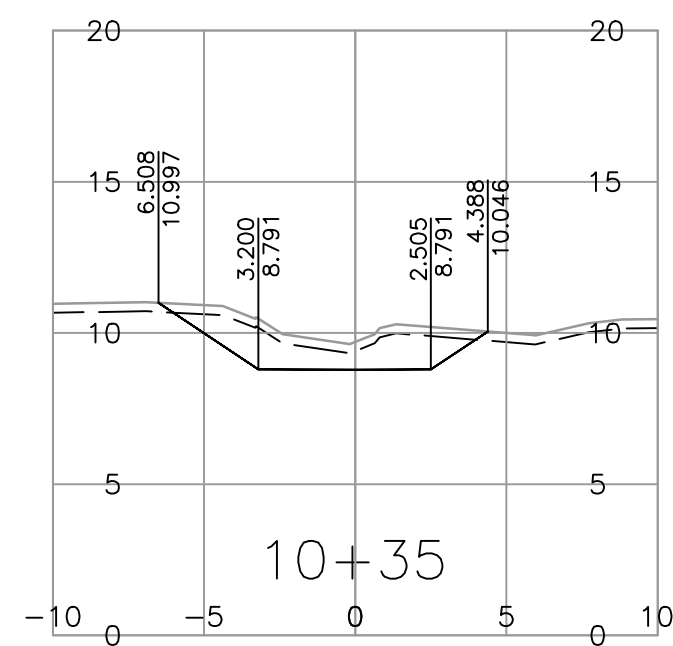
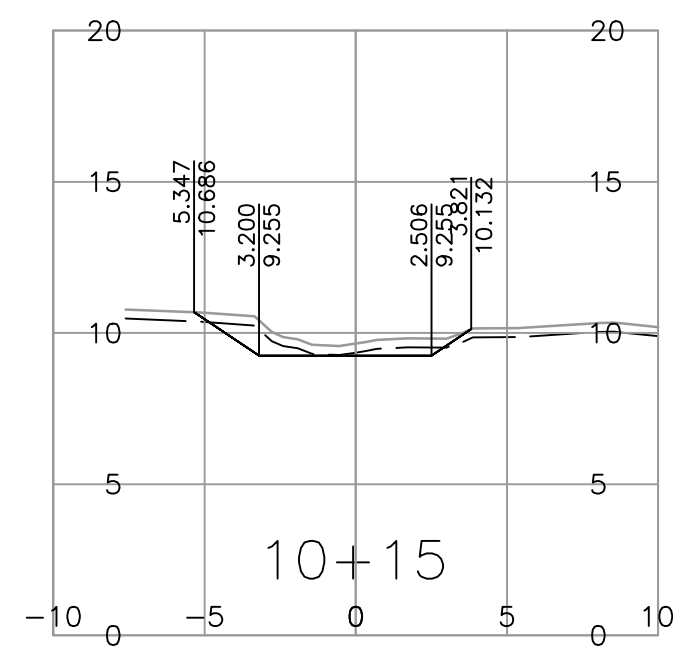
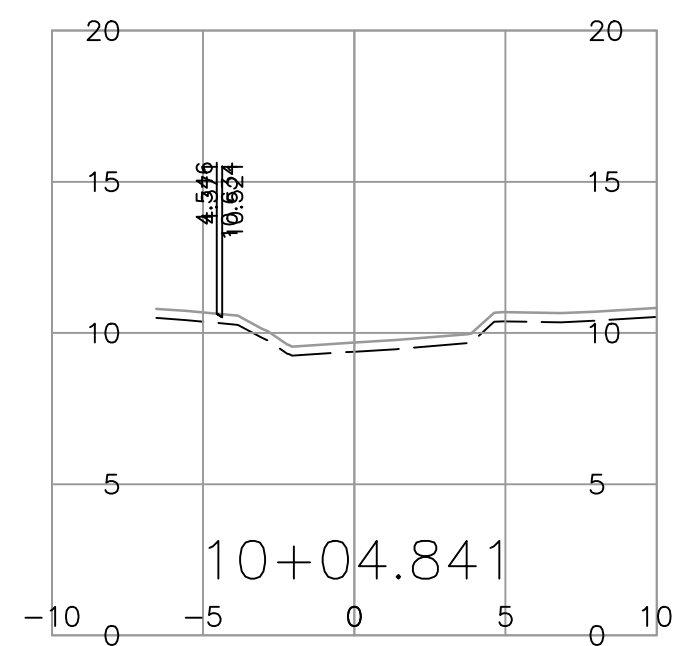
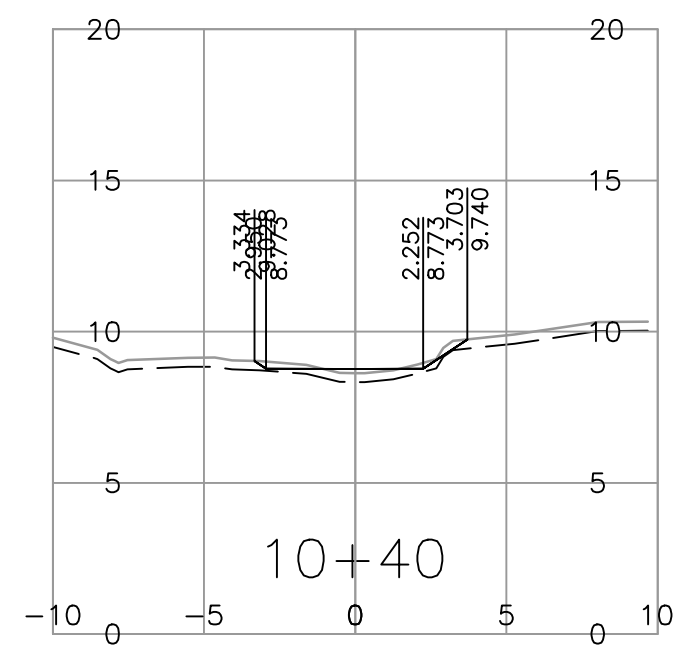
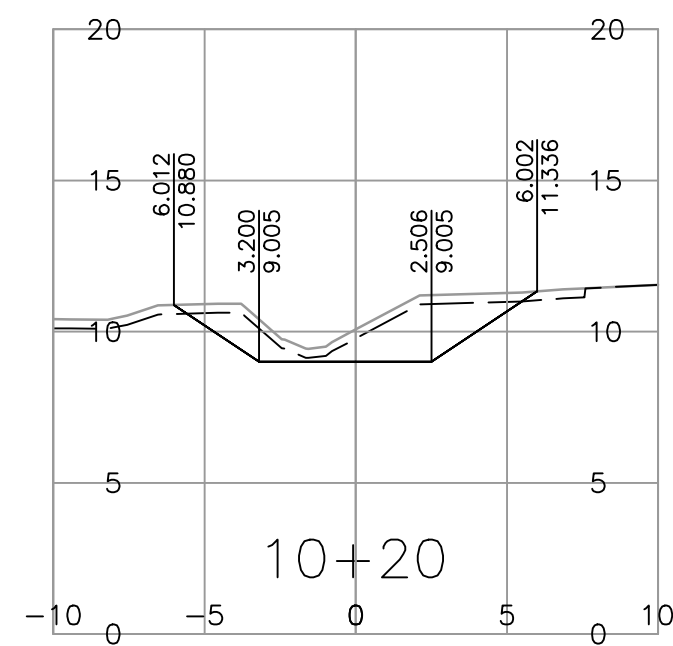
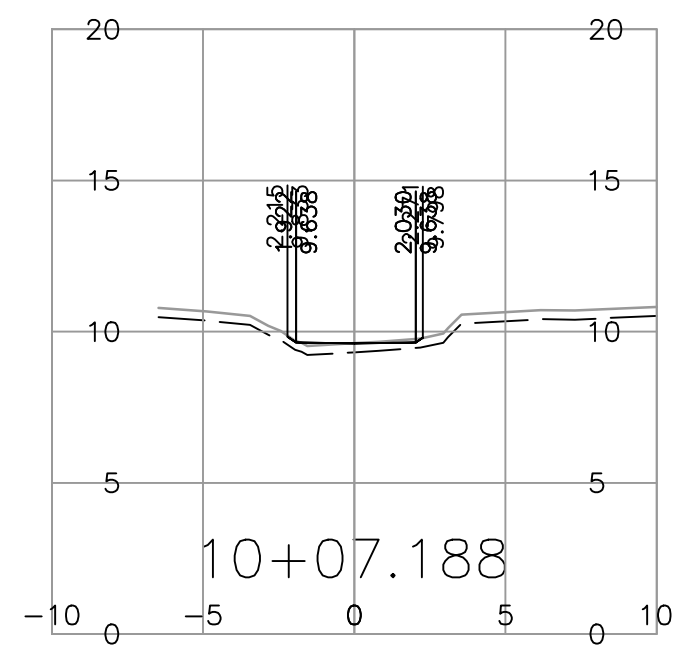
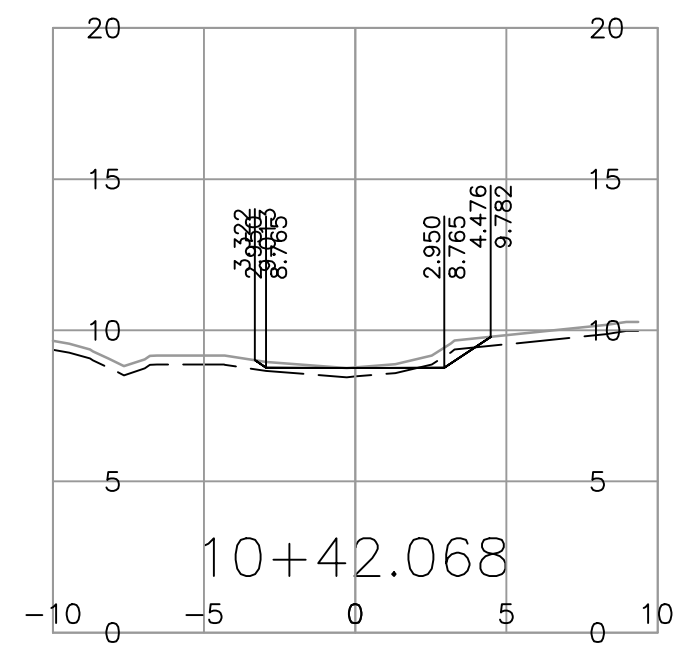
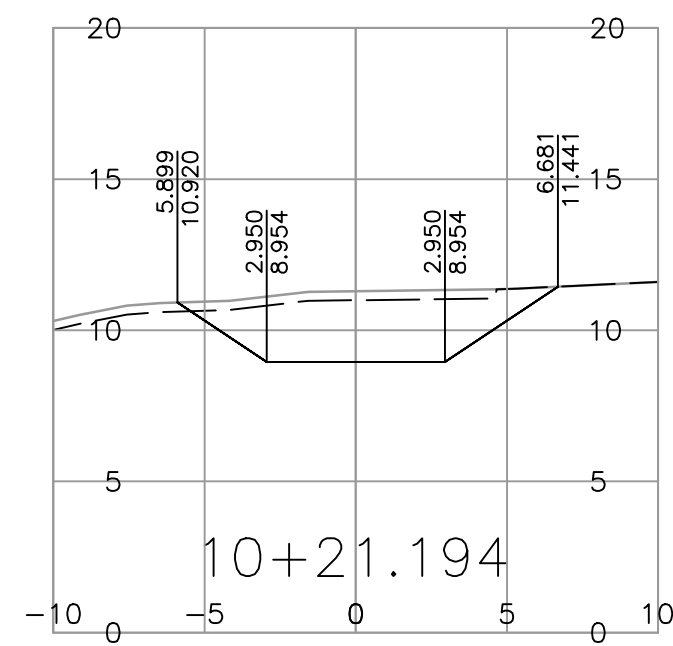
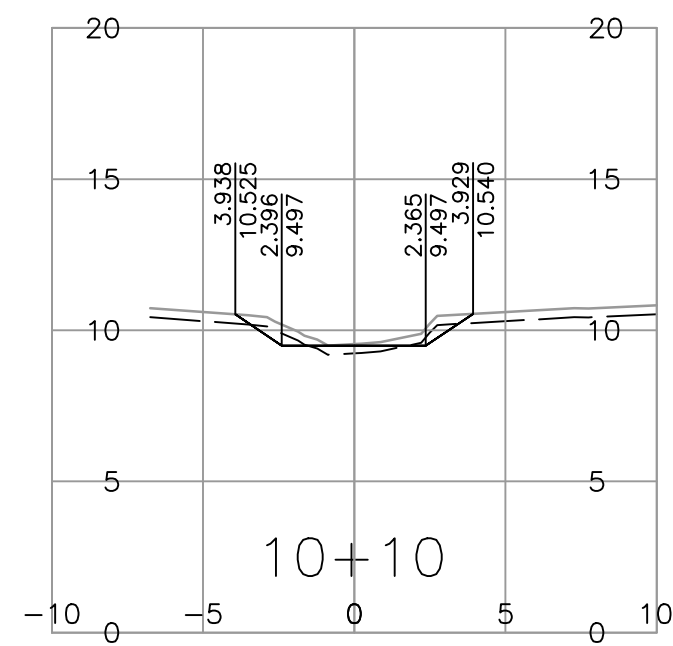
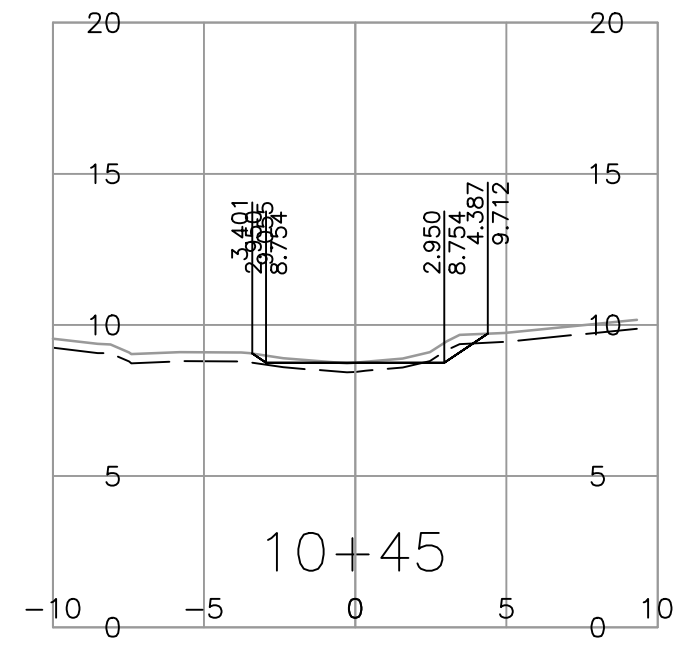
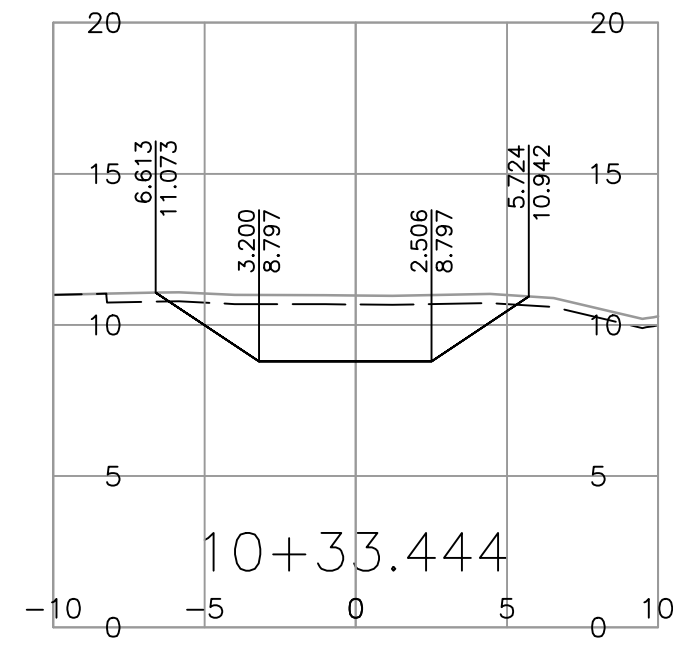
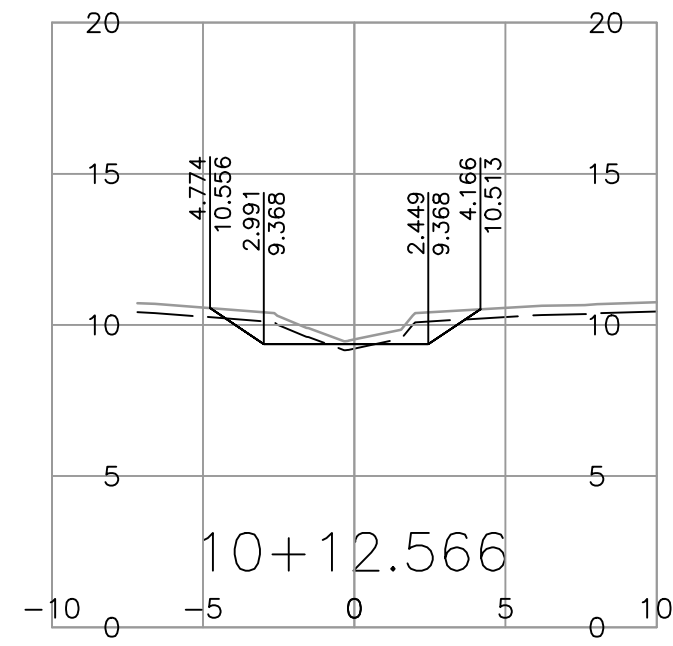

ISSUED FOR
100% DESIGN
2024-01-26
urbansystems.ca



SCALE 0 2 1:250 12m

CAD FILENAME R1-1027-1000
PLOT DATE 2024-01-26

REV	DATE	REVISIONS	NAME
A	2017-07-01		

BRITISH COLUMBIA MINISTRY OF TRANSPORTATION AND INFRASTRUCTURE
SOUTH COAST REGION
HIGHWAY ENGINEERING AND GEOMATICS

DESIGNED S.CAVASINNI DATE 2024-01-26
QUALITY CONTROL E.PROULX DATE 2024-01-26
QUALITY ASSURANCE C.BAGG DATE 2024-01-26
DRAWN S.CAVASINNI DATE 2024-01-26

SENIOR DESIGNER _____
DATE 2024-01-26

D10 CROSS SECTIONS
PART A - FLUME CREEK
DFAA FLOOD DAMAGE

FILE NUMBER	PROJECT NUMBER	REG	DRAWING NUMBER	REV
872CS1714	14005	1	R1-1027-1000	

PLOT DATE: 2024/01/25 U:\Projects_SUR\1961\0480\14\0-Design\CAD\DrawingProduction\1000_DesignSections\R1-1027-1000.dwg

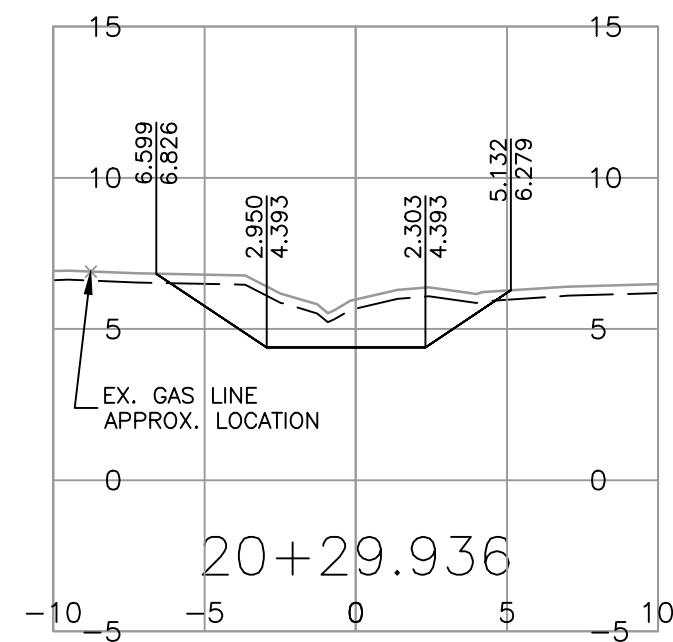
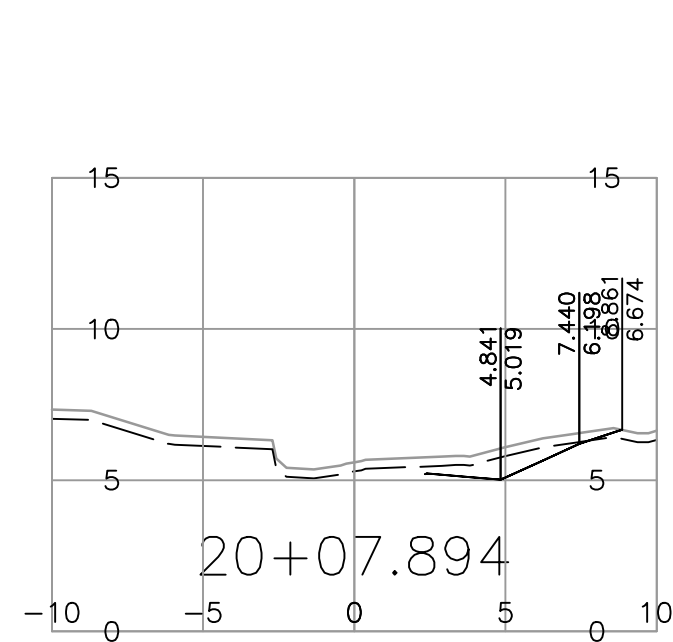
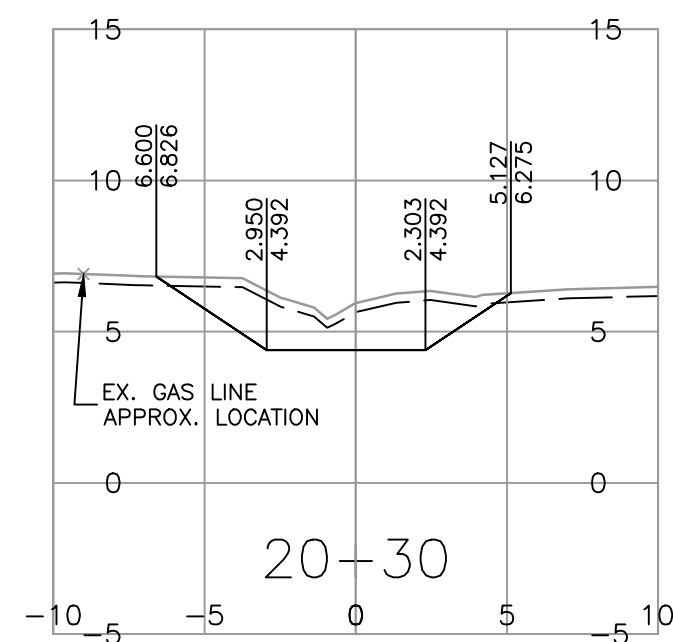
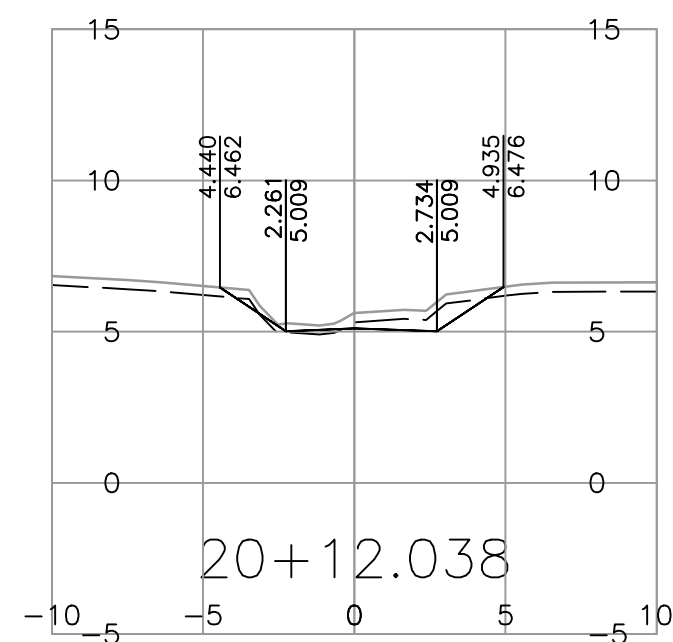
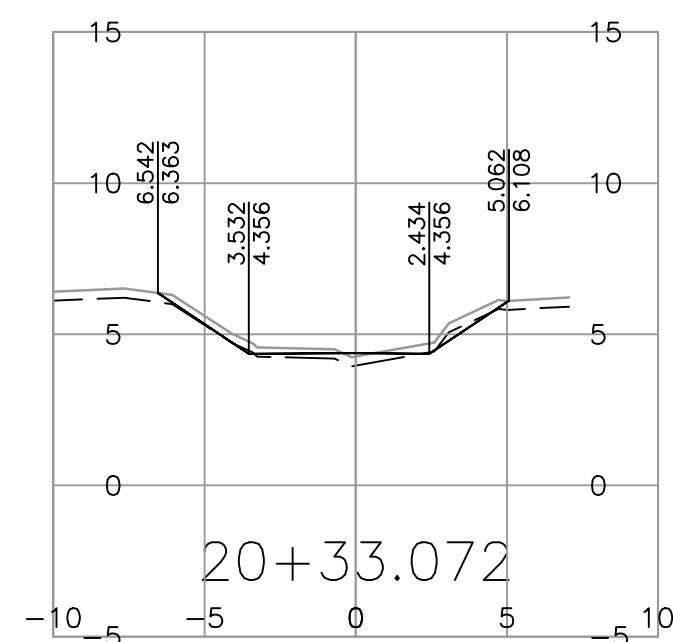
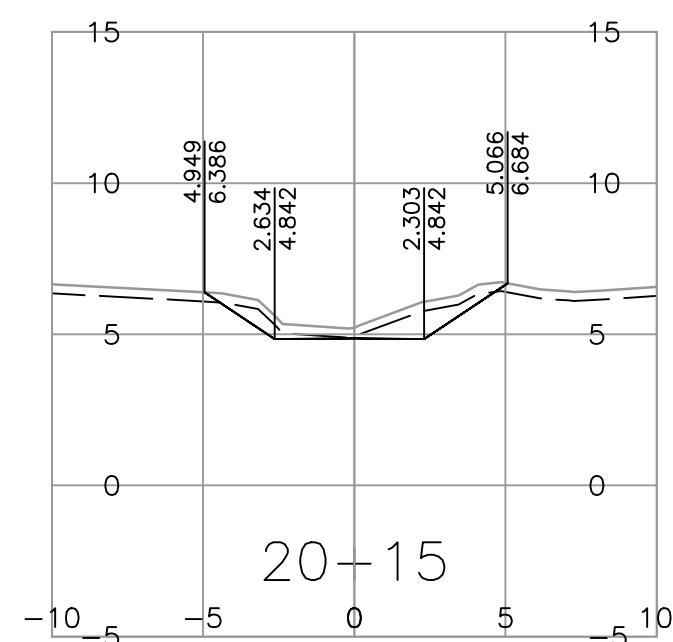
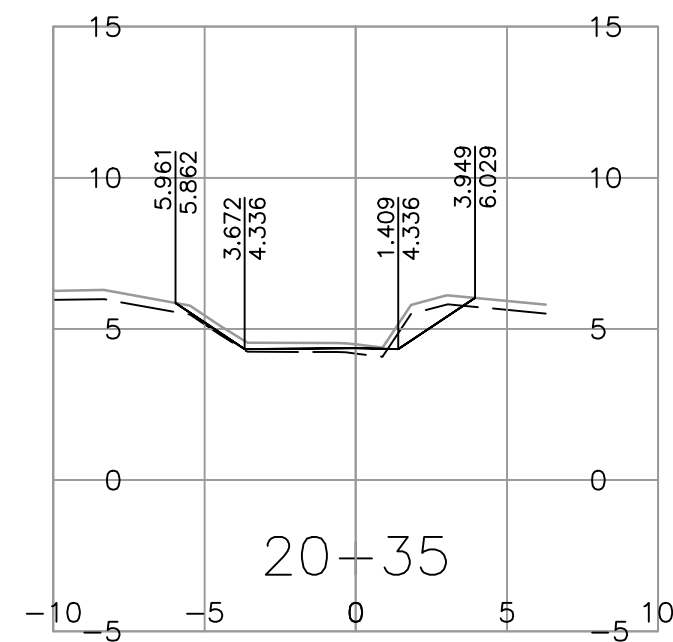
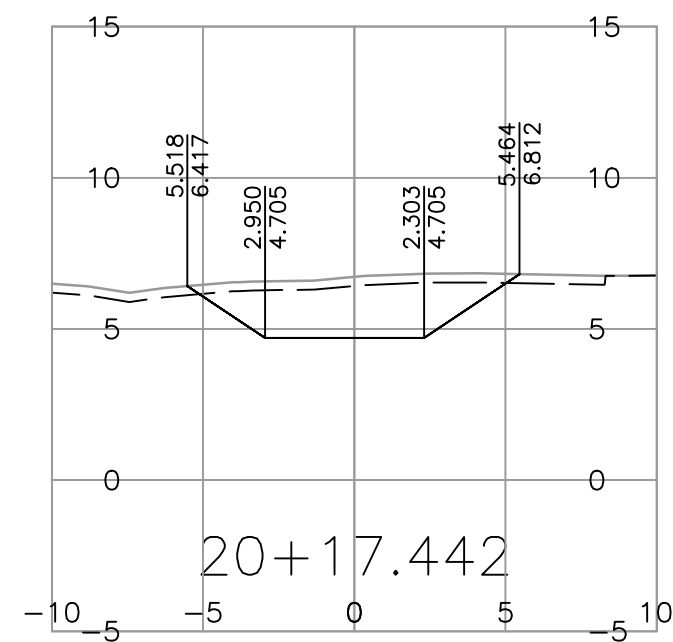

ISSUED FOR
100% DESIGN
2024-01-26
urbansystems.ca



SCALE 0 2 1:250 12m		CAD FILENAME R1-1027-1000	
		PLOT DATE 2024-01-26	
REV	DATE	REVISIONS	NAME
A	2017-07-01		

BRITISH COLUMBIA
 MINISTRY OF TRANSPORTATION AND INFRASTRUCTURE
 SOUTH COAST REGION
 HIGHWAY ENGINEERING AND GEOMATICS

DESIGNED S.CAVASINNI DATE 2024-01-26
 QUALITY CONTROL E.PROULX DATE 2024-01-26
 QUALITY ASSURANCE C.BAGG DATE 2024-01-26
 DRAWN S.CAVASINNI DATE 2024-01-26

SENIOR DESIGNER _____
 DATE 2024-01-26

D20 CROSS SECTIONS				
PART A - FLUME CREEK DFAA FLOOD DAMAGE				
FILE NUMBER	PROJECT NUMBER	REG	DRAWING NUMBER	REV
872CS1714	14005	1	R1-1027-1000	