

PART C BIOLOGICAL TESTING

©Her Majesty the Queen in
Right of the Province of British Columbia
2013
All Rights Reserved

BIOASSAYS: SAMPLE COLLECTION PLUS IN-SITU TESTS

©Her Majesty the Queen in
Right of the Province of British Columbia
2013
All Rights Reserved

Table of Contents

1.	INTRODUCTION.....	101
2.	IN-SITU SALMONID EGGS BIOASSAY	101
2.1	Background	101
2.2	Start Up	102
2.2.1	Preparation	102
2.2.2	Procurement and Transportation of Eggs.....	102
2.3	Field Deployment	103
2.4	End-Point	104
2.5	Jordon/Scotty Incubator:.....	105
3.	IN-SITU CAGED FISH BIOASSAY	105
3.1	Background	105
3.2	Start Up	105
3.2.1	Preparation	105
3.2.2	Procurement and Transportation of Fish	106
3.3	Field Deployment	106
3.4	End-Point	107
4.	GENERAL PROCEDURE FOR COLLECTION OF EFFLUENT AND WATER SAMPLES FOR LABORATORY BIOASSAYS.....	108
4.1	Background	108
4.2	Sampling	108
4.2.1	Effluents.....	108
4.2.2	Receiving waters	108
4.3	Specific Bioassay Requirements.....	108
4.3.1	Fish.....	108
4.3.2	Daphnia	109
4.3.3	Microtox.....	109
5.	SOURCES OF FURTHER INFORMATION.....	109
5.1	In-Situ Salmonid Eggs Bioassay	109
5.2	In-Situ Caged Fish Bioassays	109
5.3	Collection of Effluent and Water Samples for Laboratory Bioassays.....	110
6.	REVISION HISTORY	110

1. Introduction

Bioassay studies of toxicity can be divided into two categories -- bioassays performed in-situ, and bioassays performed at a laboratory with samples transported from a site. This chapter presents methodology information for two in-situ methods, plus sample collection techniques for several laboratory techniques. The methodology for laboratory bioassay assays are presented in Section F of the British Columbia Environmental Laboratory Manual for the Analysis of Water, Wastewater, Sediment and Biological Materials, 1994 Edition (Permittee).

In-situ bioassay studies are effective tools to assess the impact of a discharge, leachate or drainage into the aquatic environment. These studies are usually designed to evaluate the situation during a discharge event, or for upstream/downstream comparison. However, due to the physical limitations placed on the investigator and the lack of control over the metaphysical factors, the level of resolution with which pollution effects can be determined by in-situ studies is rather coarse and only substantial biological effects can be distinguished.

Currently BC Environment endorses two in-situ methods of bioassay. The first type involves use of eyed salmonid eggs, placed in modified Whitlock-Vibert boxes. This method was developed by G.C. van Aggelen and has been successfully used in a number of field investigations. The second type of in-situ bioassay involves caging fish in some form of trap or cage.

The author of this chapter assumes that the reader has a certain degree of familiarity with aquatic toxicity testing and field techniques. Explicit instructions on every detail that might be required are not provided although this procedure is intended to serve as a guide for this method.

2. In-Situ Salmonid Eggs Bioassay

2.1 Background

It is well documented that developing embryos have periods of extreme sensitivity when their susceptibility to foreign toxicants is maximal. Fish embryos are no different, with extensive data from life cycle toxicity testing to support this. The method described below is based upon starting the bioassay with Pacific Salmonid eggs that have just come into the "eyed stage" of development. Eyed stage is defined by Piper et al., U.S. Dept. of Interior, U.S. Fish and Wildlife, 1982, as the stage between the time the eyes become visible and hatching occurs.

This stage of development guarantees that the eggs have been fertilized and that the embryos are hardy enough to be handled and transported. Developmental stages prior to this are extremely sensitive to handling and transportation; mortality rates associated with these factors are very high.

2.2 Start Up

2.2.1 Preparation

Prior to conducting any field bioassay:

- It is strongly recommended that a site visit be made to establish a general feel for the area in question, sight out potential deployment areas, notify site manager(s), local neighbours, etc.
- Field dissolved oxygen, temperature, conductivity and pH should be taken.
- Local Ministry fish and wildlife and DFO habitat staff must be made aware of the intended study. Provide them with a briefing on the site location, duration and endpoints.
- An application for transplant authorization must be filed with the Federal/Provincial transplant committee. This application must detail the study, provide information on the type of eggs, their origin, and final disposal of the eggs/hatchout on completion, plus any other pertinent information. The study can not proceed without this authorization.

2.2.2 Procurement and Transportation of Eggs

Procurement of eyed salmonid eggs is determined by the transplant committee and is somewhat seasonal when from the Federal/Provincial hatchery system. Most sea run salmon eggs are available from late August until mid November. Rainbow trout are available from the government hatcheries from November until March. There are some private trout farms, certified by the transplant committee, that will have eggs available at different times of the year. The scope of the study will determine the number of eggs that are required. A target of 100 eggs per box is a good target. A thousand (1000) eggs will usually allow for three control boxes and two downstream locations. The remaining eggs can serve as tissue control.

Transportation of the eggs can be done in clean and disinfected (i.e., Wescodyn rinsed) containers that can be sealed. The eggs do not have to be placed in water as long as they are kept cool and moist. Paper towel or cheesecloth soaked in cool dechlorinated water works well. Eggs should be placed in a cooler and, if temperature is a factor, an ice pack should be added. The hatchery manager should be shown a copy of the transplant approval and you, in return, should receive information about the stocks (i.e., temperature units, disease control, stock origin, etc.) and a transfer document.

Whitlock-Vibert boxes can be obtained from the U.S. Federation of Fly Fishers, Bozán, Montana, phone: 406-585-7592. The boxes are modified by gluing nylon screen netting in the bottom chamber. This prevents any of the alevins from escaping and prevents predators from entering. New boxes should be soaked for a minimum of 24 hours prior to using.

Chicken wire baskets roughly one square foot in dimension are ideal for placing the incubation boxes inside. Rolls of chicken wire can be readily purchased from hardware stores. It is best not to use galvanized chicken wire. Nylon zap straps are ideal for sealing up the wire cages.

If the site has limited spawning size gravel (inch - inch and a half), it is strongly recommended that the correct size of gravel be purchased, cleaned and placed in buckets that enable easy carrying to the site. (Hint: better to have lots of little buckets than one heavy one.)

A rake and long handled shovel should be included with your field equipment.

2.3 Field Deployment

- (a) Egg boxes should be filled in the laboratory prior to travelling to the field location; 100 eggs per box works well. A beverage cooler can be used to transport charged boxes to the deployment site. Eggs must be kept out of direct sunlight as much as possible. The duration (exposure period) and development of the eggs are subject to temperature.
- (b) Different salmonid species have different rates of development. A computer programme, "SALMONID INCUBATION PROGRAMME, VERSION 1.3, DFO, PBS NANAIMO, BY J.O.T. JENSEN", is an excellent way to estimate your study exposure period. The bioassay can have several end-points. The most common are to terminate the study after controls hatch or extend the exposure until the control alevins "button up". The later will provide a longer exposure period, however, maximum length of exposure should be to the development stage of "yolk sac absorption or buttoning up". At this stage, it is recommended that the bioassay be terminated.
- (c) Site location should be excavated to a level and position such that the wire cage is slightly angled up current and, when the egg box is positioned inside it, it is level with the stream bed-water interface. Also ensure that the location will always have water flowing over the eggs.
- (d) Place the egg box in the middle of the wire cage and add clean spawning size gravel. (Hint: Customized neoprene divers gloves work well for holding the egg box in place while gravel is poured into the cage).

- (e) Once the egg box is totally covered with gravel, close the wire cage and seal it with wire or nylon zap straps. It is recommended that a minimum of three boxes be used for each site.
- (f) Field parameters such as temperature, dissolved oxygen, and pH should be measured each time the eggs are checked. Water flow rates and climatological factors should be recorded. (Note: Temperature is a critical measurement as egg development is driven by temperature.) Consequently control boxes should be placed in conditions (temperature, depth, light) as similar to test boxes as possible.
- (g) One cage at each site should be designated as the "check cage". This cage should be the only one observed during the weekly monitoring of the study. When observing the eggs, every attempt should be made to shield the eggs from direct sunlight. The checking should be conducted as quickly as possible. If a longer time (10+ minutes) is required, keep eggs moist. (Hint: An empty bucket is useful for putting removed gravel in while checking the egg box.)
- (h) Record mortality and any other pertinent observations in field note book.

2.4 End-Point

A number of end-points can be used for this type of study, however, any response has to be a statistical comparison of control survival (up-stream) against the downstream (impacted) site(s) survival. The test is invalid if there is twenty percent mortality in the control. The Toxstat computer programme version 3.2 by Gulley, Boelter and Bergman, University of Wyoming, is useful for statistical manipulations.

Mortality is the most obvious response to measure. Fish eggs turn white when they are dead. This is because the yolk contains a large amount of protein called globulin. The globulin is in solution in the yolk and is held in this state by the presence of salts. It can not remain in solution in water which contains no salts or electrolytes. The removal or diluting of salts from the yolk causes it to precipitate. In a normal egg, the yolk membranes prevent the salts from diffusing into the perivitelline space and from there through the porous egg case. Toxicants can diffuse across this membrane and cause its break down and eventually rupture.

Hatching rate is also a significant measure for this type of bioassay. It is possible for hatching to be early or delayed depending on the material and toxic action. Metals can cause impaired hatching or head encapsulation where the alevin's head becomes trapped in the egg capsule and dies. Iron or metal oxides can precipitate onto the egg's surface and cause it to suffocate.

Any surviving eggs or alevin must be returned to the laboratory and destroyed. Survivors must not be released. This is a condition of the transplant approval.

2.5 Jordon/Scotty Incubator:

The Jordan/Scotty in-stream incubators can be used as an alternative to the Whitlock-Viebert boxes. Often the spread of fungus between eggs is the main reason for high mortality rates. Fungus usually establishes itself on dead eggs but can spread to alive and healthy eggs. To avoid this phenomenon, which often occurs in the Whitlock-Viebert boxes, it is recommended that Jordan/Scotty in-stream incubators be used, since they offer small separated chambers for each individual egg. The interpretation of the observed egg mortality rates in bioassays using Jordan/Scotty incubators is not confused by mortalities due to fungus spread and can most likely be attributed to water toxicity with reference to salmonid eggs.

For drawings of the incubator and further information, see the pamphlet published by Scotty Plastics, 21 Erie St., Victoria, B.C., Canada, V8V 1P8.

3. In-Situ Caged Fish Bioassay

3.1 Background

Under certain conditions, it is possible to use caged fish to determine if deleterious effects are happening in receiving waters. The deployment of caged fish into fresh and marine waters will usually only provide the investigator with a measure of mortality.

3.2 Start Up

3.2.1 Preparation

Prior to conducting any field bioassay:

- It is strongly recommended that a site visit be made to establish a general feel for the area in question, sight out potential deployment areas, notify site manager(s), local neighbours, etc.
- Field dissolved oxygen, temperature, conductivity and pH should be taken.
- Local Ministry fish and wildlife and DFO habitat staff must be made aware of the intended study. Provide them with a briefing on the site location, duration and endpoints.

- An application for transplant authorization must be filed with the Federal/Provincial transplant committee. This application must detail the study, provide information on the type of fish, their origin, and final disposal of the fish on completion, plus any other pertinent information. The study can not proceed without this authorization.

3.2.2 Procurement and Transportation of Fish

The procurement of fish, when Environment Canada's Toxicology group is not used, will have to be done using the Federal/Provincial hatchery system. The species of fish exposed must be relevant to the site's environment and may be from indigenous or cultured stocks. Various species of salmonids are available, however, the age and size is often seasonal and species dependent. There are also private trout farms that will provide stocks. Fish farms can be contacted for marine salmonids. If marine work is intended, the stocks will have to be salinity acclimated following a suitable protocol (see Environment Canada, 1/Rm/10, for an example).

Transportation of the fish can be done in clean and disinfected containers (i.e., Wescodyn or Rocol) that can be sealed. A portable compressed air system or bottled oxygen must be provided when travelling any great distance. Temperature will also play an important factor in the summer months during transit. Dechlorinated ice blocks should be used for cooling. The fish supplier should provide you with a statement regarding the stocks' origin and any disease treatments they have undergone.

Many different cage designs have been developed to hold fish. The chief concern of the design of these is that they must be capable of sustaining fish for the duration of the exposure, not allow escape, and, at the same time, allow adequate flow. Specific designs can be tailored for the type of receiving environment (rivers, ditches, tidal areas, submerged or surface exposure conditions). Construction materials must not contribute to toxicity or injure the organisms.

3.3 Field Deployment

- (a) Cages should be positioned and secured prior to adding the fish. The control location should resemble the location of impact with regards to flow rate, geography, depth, etc. Location should take into account flow rates depth, tides, etc. In swift flowing water, back eddies or side pools work well so fish are not under constant current swimming stress. If possible, try to locate cages where direct sunlight can be avoided. When working in a marine environment, make sure rope lengths are calculated for tide changes. Floats must be brightly coloured to avoid navigation hazards for boaters.

- (b) Fish should be transported to the cage site in a sealed bucket to prevent loss. Do not overcrowd the fish in the bucket. The number of fish added to each cage is dependent on size and mass. Fish should be counted and gently added to the cage. If there is a temperature gradient difference greater than three degrees from the field location to transportation water, slowly add up-stream water to acclimate the stocks over a one hour period.
- (c) A representative number of test fish from the general test stock must be sacrificed for length and weight measurements. The potential for histological comparison is also a possibility, particularly using gill structures.
- (d) Field parameters such as DO, pH, conductivity, salinity and temperature must be recorded. An estimation of flow rate is also worthwhile.
- (e) The exposure regimes are study dependent. The majority of salmonids will have no problems going four days without feeding, provided that they were taken from a well maintained laboratory or hatchery operation. If longer exposures are warranted, some form of a feeding schedule must be established. For long term exposure, yearling fish are strongly recommended.

3.4 End-Point

Mortality is the most common end-point associated with in-situ fish studies. How long the fish have been dead will determine if histological samples are worth taking. The general rule of thumb for good gill histology is that the organism must be "just dead" or moribund for collecting tissue. "Just dead" fish typically exhibit pink or dark red gills. Consult histologist for proper staining and fixation.

The test should be considered invalid if there is greater than 20% mortality in the control cage. All impacts to the fish in the exposure cages must be compared back to the control fish.

Whatever end-point is used, it must be compared to the control observations and responses to determine if the observations are biologically different from the controls. Actual statistical calculations may prove difficult and will be highly dependent on the measured or observed variables.

At the completion of the study, all equipment must be removed and any modification(s) to the site returned to their former state. All fish must be destroyed and disposed of away from the test site.

4. General Procedure for Collection of Effluent and Water Samples for Laboratory Bioassays

4.1 Background

The physical collection of a sample for liquid phase bioassay testing will vary only slightly between the different bioassay types. The only major difference will be in the volume of material required to complete the requested bioassay(s) and the dilution series. It is strongly recommended that field staff consult the laboratory for confirmation on the amount of liquid required to conduct the requested bioassay(s).

4.2 Sampling

4.2.1 Effluents

Sampling may be done by a single grab, or composited manually over a given period of time. Once a composite sample has been collected, it should be thoroughly mixed and transferred into non-toxic shipping containers.

4.2.2 Receiving waters

Receiving water should be pumped from the designated sampling depth using clean polyethylene tubing into a clean polyethylene or polypropylene container.

4.3 Specific Bioassay Requirements

4.3.1 Fish

Sample-volume requirements depend on fish size and numbers per test solution, load-density requirements, test concentrations and the use of replicates. For single concentrations (i.e., permit compliance), sample volumes of 25-50 litres are normally required. For tests to determine an LC50, sample volumes of 60 to 100L or more are normally required.

Containers for storage and transportation of samples must be made of non-toxic material, such as lab-cleaned glass. The containers must be new or thoroughly cleaned and dried, and should be rinsed with clean water, then with the sample to be collected. The container must be filled with sample to exclude air and then be sealed. Labelling must include: sample type, location, date, and time of collection, and name of sampler.

Samples should be kept from freezing. During transport, samples should be kept dark, and at a temperature of 1°C to 8°C if more than two days are spent in transit.

4.3.2 Daphnia

The volume of material required to conduct the bioassay is two litres. Only clean non-toxic bottles are to be used and are to be brim full. The same shipping and handling procedures as above apply.

4.3.3 Microtox

The volume of material required is 500 mL to 1000 mL; this will allow for portions to be used for measuring initial DO and pH. It is recommended that samples be collected in borosilicate glass with screw caps lined with Teflon. The same conditions as above apply for handling and transportation.

5. Sources of Further Information

5.1 In-Situ Salmonid Eggs Bioassay

Whitlock, D. Sept. 1977. The Whitlock-Vibert Box Handbook. Federation of Fly Fishermen.

Meehan W.R. (editor). 1991. Influences of Forest and Rangeland Management of Salmonid Fishes and Their Habitat. American Fisheries Society. Special Publication 19.

Piper, R.G., McElwain, Orme, McCraren, Fowler, Leonard. 1982. Fish Hatchery Management. U.S. Fish & Wildlife, Washington D.C.

Scott Plastics Ltd. 2000, Jordan/Scotty Salmonid Egg. Incubator, 10pp.

5.2 In-Situ Caged Fish Bioassays

Sprague, J.B. 1973. The ABC's of Pollutant Bioassay Using Fish. In Biological Methods for the Measurement of Water Quality. ASTM STP 528. American Society for Testing and Materials, Philadelphia, PA.

September 1992. Technical Guidance Manual for Aquatic Environmental Effects Monitoring. Environment Canada, Department of Fisheries and Oceans.

Environmental Protection Series. July 1990. Biological Test Method: Acute Lethality Using Three Spine Stickleback. Report 1/RM/10.

5.3 Collection of Effluent and Water Samples for Laboratory Bioassays

September 1992. Technical Guidance Manual for Aquatic Environmental Effects Monitoring. Environment Canada, Department of Fisheries and Oceans.

Environmental Protection Series. July 1990. Biological Test Method: Acute Lethality Using *Daphnia* spp. Report 1/RM/11

Environmental Protection Series. July 1990. Biological Test Method: Acute Lethality Using Rainbow Trout. Report 1/RM/9

Environmental Protection Series. July 1992. Biological Test Method: Toxicity Test Using Luminescent Bacteria. Report 1/RM/24

British Columbia Environmental Laboratory Manual For the Analysis of Water, Wastewater, Sediment and Biological Materials, 1994 Edition (Permittee). Environmental Protection Department, Ministry of Environment, Lands and Parks, Victoria, Canada.

6. Revision History

- October 11, 2013: This section republished without change. Appendix 2 - Sample containers, StorageTM, Preservation and Holding Times and Appendix 3 - Laboratory Sample Container, Preservation, and Hold Times for Fresh Water Biological Sampling updated.
- February 28, 2001: Addition of Information about this Jordon/Scotty salmonid egg incubator. Out of print reference deleted.
- November 1996: Initial Publication.

BIOLOGICAL SAMPLE COLLECTION: FRESHWATERS

©Her Majesty the Queen in
Right of the Province of British Columbia
2013
All Rights Reserved

Table of Contents

1.	INTRODUCTION.....	114
2.	GENERAL CONSIDERATIONS	115
2.1	Preparing to Go to the Field	115
2.2	Locating the Site in the Field	115
2.3	Field Notes/Observations	115
3.	QUALITY ASSURANCE/QUALITY CONTROL	116
3.1	Field Quality Assurance	116
3.1.1	Technique/Diligence	117
3.2	Field Quality Control	118
3.2.1	Replicate Samples.....	119
3.2.2	Split Samples.....	119
3.2.3	Reference Samples	119
4.	COLLECTING AND PROCESSING BIOLOGICAL SAMPLES	120
4.1	Lake Biological Samples	120
4.1.1	Bacteria	120
4.1.1.1	Shore Samples	120
4.1.1.2	Surface Bacteriological Samples at Deep Stations	121
4.1.1.3	Deep Samples	122
4.1.2	Zooplankton.....	123
4.1.3	Phytoplankton.....	125
4.1.3.1	Surface Samples	126
4.1.3.2	Deep Samples	126
4.1.4	Benthic Fauna	127
4.1.4.1	Grab Sampling.....	129
4.1.4.2	Core sampling.....	130
4.1.5	Macrophytes	131
4.1.5.1	Taxonomy	132
4.1.5.2	Tissue Analysis.....	135
4.1.5.3	Biomass Studies	135
4.1.6	Fish.....	136
4.1.6.1	Gill Nets	136
4.1.6.2	Beach Seining.....	139
4.1.6.3	Set Lines.....	141
4.1.6.4	Processing Fish Tissues.....	142
4.2	River/Stream Biological Samples	144
4.2.1	Bacteria	144
4.2.2	Periphyton	146
4.2.3	Benthic Fauna (macro-invertebrates)	148
4.2.3.1	Surber Sampler.....	149
4.2.3.2	Hess Sampler	150
4.2.3.3	Drift Net Sampler	151

4.2.4	Macrophytes	153
4.2.5	Fish.....	153
4.2.5.1	Gill Nets	154
4.2.5.2	Seining.....	155
4.2.5.3	Set Lines.....	156
4.2.5.4	Electrofishing	156
5.	SHIPPING	157
6.	SOURCES OF FURTHER INFORMATION	158
7.	REVISION HISTORY	160
APPENDIX 1	GENERIC FIELD CHECKLIST	161
APPENDIX 2	LAB SAMPLE CONTAINER, PRESERVATION, AND HOLD TIMES FOR SEDIMENTS AND TISSUES	163
APPENDIX 3	LABORATORY SAMPLE CONTAINER, PRESERVATION, AND HOLD TIMES FOR FRESH WATER BIOLOGICAL SAMPLING	165

1. Introduction

This section covers the minimum requirements to ensure quality and consistency of the field aspects of biological data collection. The essential tasks in biological sampling are to collect representative samples that meet the requirements of the program, and to prevent deterioration and contamination of the samples before analysis. The procedures outlined in this manual are oriented primarily towards BC Environment employees, consultants, or those under a legal requirement to undertake a sampling program for the Ministry. Following the protocols outlined in this manual will aid field staff in collecting reliable, representative samples.

The protocols presented here are the most acceptable ones used at present. It should be emphasized that in unusual circumstances or with development of new methods, experienced professional judgment is a necessary component of method choice and application. It is intended that this document will be updated as the need arises to incorporate new knowledge. For specialized sampling needs, a considerable literature exists which can be consulted. This is particularly the case with benthic stream invertebrates.

This manual does not address the collection of samples for the purpose of providing legal evidence. For information regarding legal sampling refer to *Guidelines for the Collection and Analyses of Water and Wastewater Samples for Legal Evidence* (Lynch and van Aggelen, 1994).

This section does not address project design (site locations, frequency of sampling, duration, quality assurance program, etc.) or data interpretation. These topics are the subject of separate sections.

The sample containers, preservatives and sampling procedures described in this manual reflect those generally used by BC Environment staff. Shipping procedures and safety measures are also outlined. Different agencies or laboratories may have specifications which differ from those described here.

It should be acknowledged that funding for the initial manuscript upon which this section is based was provided by the Aquatic Inventory Task Force of the Resource Inventory Committee.

2. General Considerations

2.1 Preparing to Go to the Field

Preparation for each sampling trip is critical since oversights are not usually noticed until staff reach the first station. The most effective way to prepare for a sampling trip is with a **checklist** that is designed to meet the requirements of each project. Other than considering site-specific instructions, the checklist should identify the following needs:

- Type and number of (labeled) bottles, including extras
- Field equipment such as sediment grabs, invertebrate samplers, fish nets, tow nets, etc.
- Preservatives
- Appropriate quantity of ice packs and coolers
- Log books
- Personal gear (for all possible weather conditions such as survival suits, raincoats, protective footwear, etc.)
- First aid kit and other safety equipment (life jackets, survival suits)
- Camera or video equipment as required
- Laboratory requisition forms (partially filled out)

A general operating procedure is to have the essential equipment in a box or plastic “tote” which is dedicated to this activity. See Appendix 1 of this chapter for an example of a generic checklist.

2.2 Locating the Site in the Field

It is the responsibility of the field staff to locate all sampling stations accurately. Only if the same location is sampled consistently can temporal changes in the water quality be interpreted with confidence. Therefore, accurate station location descriptions (that identify key landmarks) must be prepared on the first visit to every sampling site. Good photographic documentation is the best way of ensuring that each site is easily recognized. A map that labels the sample sites should accompany the **site identification log book**. This log book can be in the form of a 3-ring binder with a 1:50 000 map. The basic site location data (latitudes, longitudes, map sheet number, site identification number, etc.) should be incorporated into the database (EMS in the case of BC Environment).

2.3 Field Notes/Observations

Good sampling practice always involves the use of detailed field notes. Specific information about seemingly unimportant facts such as the time of day or weather conditions are often important when interpreting data. A **field log book** (3-ring binder with waterproof paper) for each project is mandatory. All field measurements (DO, temperature, conductivity, etc.) should be entered (by date) directly into this field log book. The following list emphasizes those observations that should be recorded for biological variables:

- Site name and EMS code
- Date and time
- Weather
- Names of all the personnel on the sampling crew
- Station depth (phytoplankton, zooplankton, fish)
- Tow volumes (zooplankton) (net mouth size, mesh size, tow depth)
- Surface area sampled (periphyton)
- Fish species collected including sex, weight, length, and comments regarding general appearance (health)
- Preservatives used (for each sample)

All information recorded in the log book should be initialed by the data recorder and entered into the database as soon as possible upon return from the field.

The field note book is a very important document and it should be stored as an archival document for future reference.

3. Quality Assurance/Quality Control

3.1 Field Quality Assurance

The field quality assurance program is a systematic process which, together with the laboratory and data storage quality assurance programs, ensures a specified degree of confidence in the data collected for an environmental survey. The field quality assurance program involves a series of steps, procedures, and practices which are described below.

3.1.1 Technique/Diligence

The quality of data generated in a laboratory depends, to a large degree, on the integrity of the samples that arrive at the laboratory. Consequently, the field investigator must take the necessary precautions and have the appropriate knowledge to collect representative samples and protect samples from contamination and deterioration. Included in this category are consistency of sampling, correct use of equipment, and detailed field notes.

There are many sources of contamination; the following are some basic precautions to heed for biological samples particularly where **tissue samples** are to be obtained and processed:

- Sample containers, new or used, must be cleaned according to the recommended methods and certified by the issuing laboratory as 'contamination free' (if pre-cleaned by the laboratory). Pre-cleaned bottles must be supplied with caps attached. Always label and store pre-cleaned bottles in plastic bags to avoid confusion and contamination during transport.
- Only the recommended type of sample container for each analysis should be used. Use only certified contamination free preservatives.
- The inner portion of sample bottles and caps must not be touched with **anything** (e.g., bare hands, gloves, etc.) other than the sample itself.
- Sample containers must be kept in a clean environment, away from dust, dirt, fumes and grime. Bottles must be capped at all times and stored in clean shipping coolers both before and after the collection of the sample. Vehicle cleanliness is an important factor in eliminating contamination problems.
- Petroleum products (gasoline, oil, exhaust fumes) are prime sources of contamination. Spills or drippings (which are apt to occur in boats) must be removed immediately. Exhaust fumes and cigarette smoke can contaminate samples with lead and other heavy metals. Air conditioning units are also a source of trace metal contamination.
- Samples must never be permitted to get warm; they should be stored in a cool place. Coolers packed with ice packs are recommended (most samples must be cooled to 4°C during transit to the laboratory; some are required to be frozen through the use of dry ice). Conversely, samples must not be permitted to freeze unless freezing is part of the preservation protocol.

- Samples must be shipped to the laboratory without delay so that they arrive within 24 hours of sampling. Samples must be analyzed within the time limits set out in Appendix 2
- of this chapter.
- The sample collectors should keep their hands clean and refrain from smoking or eating while working with biological samples.

For **taxonomic samples**:

The following is the basic information which must accompany samples:

- Collection site (gazetted name, preferably with latitude and longitude and the sample site number),
- Collection date (using the Y/M/D convention written as "1999 June 12" not 99/06/12!!),
- Sampler's name,
- Collection method and details (e.g., net mouth size).

All of these data should be recorded in such a way that they will remain legible. Labels inside bottles filled with wet samples should be written with pencil on paper labels designed for this use.

As part of the lab taxonomic identification process, verification of taxa by recognized experts should be routine.

Voucher specimens should be retained for future reference and reverification. Voucher material should be stored using museum standards for preservation. At present, this is 125 mL Flint glass jars with wide mouth, plastic caps with a plastic gasket and liner. Preservatives should be noted under different sample types.

3.2 Field Quality Control

Quality control is an essential element of a field quality assurance program. In addition to standardized field procedures for biological sampling, field quality control requires, at the very minimum, the submission of replicate samples for all variables and reference samples for macro-invertebrate and fish tissue samples. Replicate samples detect heterogeneity within the environment, allow the precision of the measurement process to be estimated, and provide a check on the reproducibility of the sampling. There are many aspects to laboratory QA/QC noted below, and the field and lab aspects typically have to be considered together. One essential component is reference samples. They are used to document the bias of the analytical (laboratory) process. The timing and the frequency of replicate samples are established in the project design and will vary with each project.

3.2.1 Replicate Samples

To determine the degree of heterogeneity within the biological community being sampled, it is necessary to take replicate samples. These replicates can consist of multiple samples (grabs, tows, or whole fish) from the same general area (to measure how well a single sample represents the community or how many samples are necessary to achieve some level of sampling confidence), or portions of a single sample (i.e., sectioned grabs - to measure more localized invertebrate heterogeneity).

3.2.2 Split Samples

Split samples are aliquots taken from the same container and assumed to be identical. These samples can be sent to two or more laboratories for separate analysis and the results can be used to determine interlab variability of the different laboratories or the consistency of results within one lab.

3.2.3 Reference Samples

For tissue samples, laboratory tested and preserved reference materials are available. For example, the National Research Council of Canada has dogfish liver and muscle tissue and lobster hepatopancreas tissue for the determination of trace elements and organomercury. These reference tissues have been subjected to a large number of analyses performed by independent laboratories using several different analytical techniques. Consequently, the NRC provides mean values and confidence intervals for these substances. Other reference tissues are available from other sources.

For taxonomy samples, some basic taxonomic reference materials are available. The US EPA is one source of these at least for algal taxonomy, chlorophyll *a* and some bacterial species.

These reference samples should be submitted to the analyzing laboratory along with the samples collected during a field trip. They should be transferred to a regular sample container and labeled with plausible site names and numbers (the codes used for identification must be documented in the field log book).

4. Collecting and Processing Biological Samples

4.1 Lake Biological Samples

The collection of deep water samples requires that at least one member of the sampling group be very familiar with boat operation and safety. **If the sampling trip involves the use of a boat, then the weather forecast or marine conditions should be obtained prior to departure from home. If conditions are poor, then the sampling trip should be postponed.**

4.1.1 Bacteria

Samples collected for bacterial analysis are simply grab water samples collected at designated sites. They can be collected at near shore or deep water stations. Deep samples require the use of a Van Dorn bottle for the sample collection (Figure 1). **All bacteriological samples must be cooled (to 4°C) as soon as they are collected and must be shipped to the lab as soon as possible.** The following are the protocols for collecting shore samples, deep water surface samples, and depth profile samples.

4.1.1.1 Shore Samples

To avoid contamination from suspended sediments, the sample collector must wade out past the point where wave action affects the lake bottom. In most cases, this distance is not far from shore. **The sampler should not exceed a depth where there exists a reasonable possibility that water might unexpectedly enter the gum-boot or hip-wader.** This is particularly important during colder weather when getting wet poses a health risk (such as hypothermia).

PROTOCOL (shore samples)

- (a) Obtain labeled, sterilized, 250 mL bottles and wade into the lake at the most accessible point.
- (b) Once you reach a sufficient depth (where bottom material will not interfere with the sample), stop and orient yourself towards the center of the lake. Often samplers wait standing in place for 2 - 3 minutes to ensure sediment disturbed by wading can settle.
- (c) Remove the lid and hold it aside without allowing the inner surface to touch anything.

- (d) With your other hand, grasp the bottle well below the neck. Lean out towards the center of the lake and in one continuous motion plunge the bottle beneath the surface to a standardized depth (two frequently used depth for surface samples are 0.1 m and 0.5 m) and slowly force it through the water until it is entirely full. This motion creates a current over the mouth of the bottle such that water entering the bottle has not come in contact with your hand.
- (e) Pour out enough water to provide 2.5 - 5 cm air space above the sample. Replace the cap immediately.
- (f) Return to shore and pack the sample in a cooler containing a sufficient quantity of ice packs (twice the volume of ice to samples in summer months or equal volume when sampling in winter months).

4.1.1.2 Surface Bacteriological Samples at Deep Stations

PROTOCOL

(for collecting surface samples at deep stations)

- (a) The person at the bow (front) should always collect the samples. This is because the bow is the anchor point and even in a slow current the boat will drift so that the bow is upstream. This precaution reduces the potential of contamination from the boat or motor. The person in the stern (rear) can be responsible for holding the boat's position (when not anchored), taking the field measurements, and making field notes, and helping to stabilize boat when bow person is working near gunwales.
- (b) Obtain a labeled, sterilized, 250 mL sample bottle and remove the lid without touching the inner surface of either the bottle or lid.
- (c) Reach out an arm length from the boat to take the sample. Ensure that the person in the stern is providing counterbalance (working over the opposite side of the boat).
- (d) Plunge the bottle under the surface and move it slowly towards the current (the direction the boat is facing) until the bottle is entirely full.
- (e) Pour out enough water to provide a 2.5-5 cm air space above the sample.
- (f) Recap the bottle and place in a cooler immediately.

4.1.1.3 Deep Samples

Deep samples are usually collected by Van Dorn sampler. Note that Van Dorn samplers are available in both horizontal and vertical configurations. The advantage of the vertical configuration is that the water within the open bottle is flushed out as the bottle is lowered so that one can be guaranteed that the water was collected from the indicated depth. The advantage of the horizontal configuration is that a very narrow depth range is sampled. Vertical configurations are usually used in large lakes. Horizontal configurations are used for samples to be collected at or just above/below a very sharp thermocline, or to be collected near the lake bottom. Horizontal configurations are mandatory for very shallow lakes.

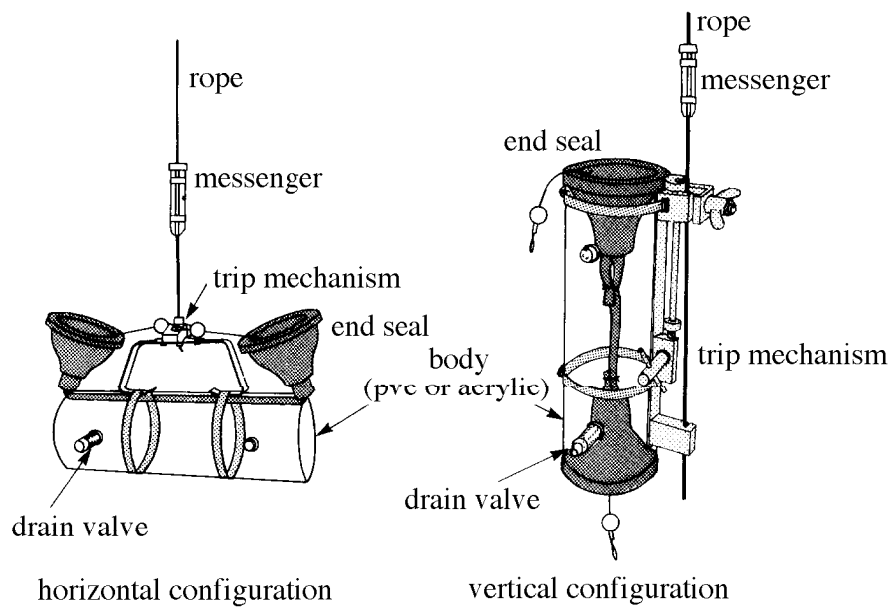

Figure 1. Van Dorn Sampler

PROTOCOL
(for taking deep samples)

- (a) Open the Van Dorn sampler by raising the end seals.
- (b) Set the trigger mechanism as in Figure 1.
- (c) Lower the sampler to the desired depth. Ensure that the dead end of the rope is tied to the boat.

- (d) Send the messenger down to “trip” the mechanism that closes the end seals.
- (e) Retrieve the sampler to the surface.
- (f) Flush the drain valve with some of the sample water so as to reduce the possibility that bacteria from previous sample sites will contaminate the current sample. Then, transfer the water sample from the Van Dorn bottle to sterilized, labeled, 250 mL sample bottles via the drain valve. Leave a 2.5-5 cm air space at the top of the bottle. **Take care to avoid contact with the drain spout as contamination often occurs at this stage.**
- (g) Recap the bottle and place in the cooler immediately.

4.1.2 Zooplankton

Zooplankton, or planktonic animals, are free floating and suspended in open or pelagic waters. They are generally collected with a conical net (Figure 2) that has a specific mesh size (ranging from as small as 64 μm to as large as 256 μm). Small mesh openings will clog more readily than larger ones, but small organisms will pass readily through larger openings. The mesh size required for a particular lake will depend on the productivity of the lake and the purpose of the study. The size of the mesh and the diameter of the net opening used for each BC Environment project will be clearly outlined in the project design. The preferred net mesh, when appropriate, is 64 μm with a net mouth diameter of 20 cm.

The net is lowered to a particular depth and pulled directly up through the water column (known as a vertical tow). Alternatives to the vertical tow are the horizontal and oblique tows in which various strata of the lake are sampled individually (a horizontal tow) or as a composite (oblique tow). These are elaborate techniques that require specialized equipment rigged to the boat and a tow net that has remote open and close capabilities. Unless there is specific need for data from horizontal and oblique tows they are not used. Therefore, the vertical tow is the only protocol that will be mentioned here.

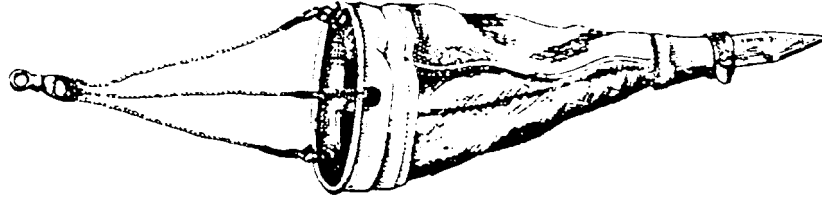

Figure 2. Plankton tow net

PROTOCOL
(vertical tow)

- (a) Ensure rope is securely fastened at the plankton net opening and that the dead end is tied to the boat.
- (b) At the designated site, lower the net to depth outlined in the project design.

Note: The actual distance that the net travels through the water must be recorded and the total volume of water that passes through the net must be calculated (see Figure 3).

- (c) In smaller lakes, haul the net hand over hand with a steady, unhurried motion at a rate of 0.5 m/s. In large lakes, when long net hauls are conducted, use a davit, meter wheel, and winch.
- (d) Once the net is at the surface, wash the net by raising and lowering the net body below the net mouth in the water. Then squirt de-ionized water against the outside of the netting and from the top downward. This washes any adhered plankton down into the cod-end (removable 'cup' at the end of the net).
- (e) Disconnect the cod-end and carefully decant the water and plankton into a pre-labeled bottle. Rinse the cod-end several times, pouring each rinsate into the bottle (this ensures that all plankton are collected).

- (f) Wash the net by rinsing (pulling it through the water without the cod-end). This is an absolute necessity before proceeding to the next sample site (particularly between lakes).
- (g) Preserve the sample with 70% ethanol (70mL of 100% ethanol for each 30 mL of sample volume) and place in the cooler for shipping.

Volume of water through a zooplankton tow

$$V = \pi r^2 d$$

where:

v = volume of water filtered through sampler

$\pi = 3.1416$

r = radius of net mouth

d = depth of net sampler at start of vertical haul
(total length of course through water)

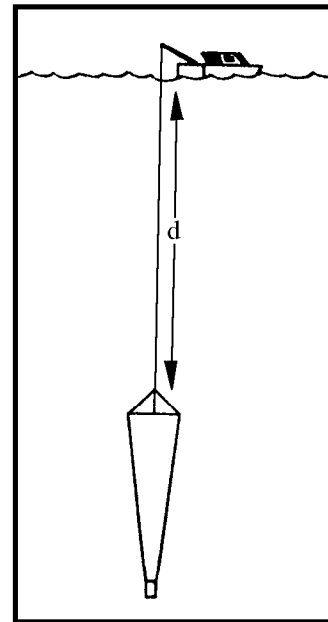

Figure 3. Tow volume calculation

4.1.3 Phytoplankton

Phytoplankton collection in the open water of a lake consists of surface and/or deep grab sampling. A Van Dorn bottle is the most common tool for collecting the deep samples.

4.1.3.1 Surface Samples

PROTOCOL

(for collecting surface phytoplankton samples)

- (a) Anchor the boat at the designated sample site (alternatively, if the water is too deep or a buoy is not present, the person in the stern will have to maintain position while the person in the bow takes the samples).
- (b) Obtain a labeled, 1 litre sample bottle and remove the lid without touching the inner surface of either the bottle or lid.
- (c) Reach out an arm length from the boat to take the sample. Ensure that the person in the stern is providing counterbalance (working over the opposite side of the boat).
- (d) Plunge the bottle under the surface and move it slowly towards the current (the direction the boat is facing) until the bottle is entirely full. Standard sampling depths for “surface” water samples are 0.1 m and 0.5 m.
- (e) Preserve the sample with 3 mL of Lugol’s solution (3-4 mL per 1 litre of sample). A general guideline is that there be sufficient Lugol’s to turn the sample the colour of weak tea.

Note: Plankton nets for phytoplankton samples are not recommended for quantitative samples. They are size selective and very non-quantitative. They can be used however for identification of the species present as the larger density assists in the taxonomic work.

4.1.3.2 Deep Samples

PROTOCOL

(for collecting deep water samples)

- (a) Open the Van Dorn sampler by raising the end seals.
- (b) Set the trigger mechanism as in Figure 1.

- (c) Lower the sampler to the desired depth (epilimnion, hypolimnion or thermocline - the location of which should have been determined by prior DO/temperature profile data collection - see Ambient Freshwater Sampling chapter). Ensure that the dead end of the rope is tied to the boat.
- (d) Send the messenger down to “trip” the mechanism that closes the end seals.
- (e) Retrieve the sampler to the surface.
- (f) Transfer the water sample from the Van Dorn bottle to labeled, 1 liter sample containers via the drain valve.
- (g) Preserve the sample with 3 mL of Lugol’s solution (3-4 mL per 1 liter of sample).
- (h) Recap the bottle and place in the cooler.

4.1.4 Benthic Fauna

Benthic invertebrates in lakes or large slow moving rivers are generally collected in the same fashion as sediment samples (see Collection of Lake and Stream Bottom Sediment Samples chapter). The processing of the sample once it has been collected is where the techniques differ. The sampling equipment is described in the section titled ‘*sediment sampling*’, and consequently, will not be discussed here. The type of grab sampler to be used at a particular site will depend on the site conditions and the purpose of the study. The equipment to be used will be dictated by the project design and must be outlined in the field log book and pre-sampling checklist. Figure 4 presents the grab samplers that are available, while Figure 5 presents the core sampler most commonly used.

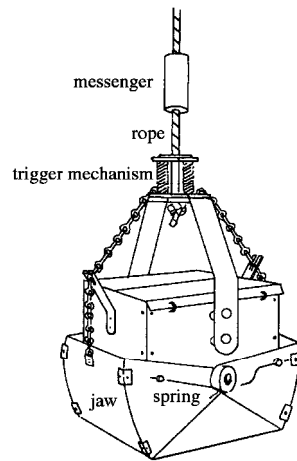

Ekman grab

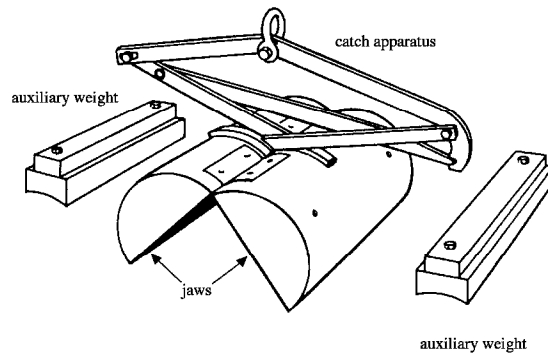

Petersen Grab

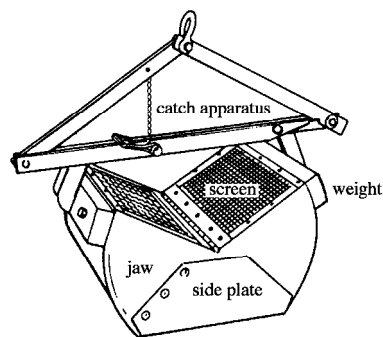

Ponar grab

Figure 4. Common Sediment Grab Samplers

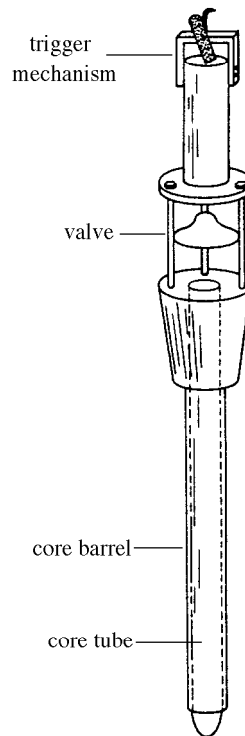

Figure 5. Kajak-Brinkhurst Sediment Core Sampler

4.1.4.1 Grab Sampling

PROTOCOL

(boat sampling with a grab sampler)

- (a) Ensure that the rope is securely fastened to the sampler and that the dead end of the rope is tied to the boat.
- (b) Set the grab sampling device with the jaws cocked open (see Figure 4). **Great care should be taken while dealing with the device while it is set as accidental closure can cause serious injuries.**
- (c) Lower the sampler until it is resting on the sediment (its own weight is adequate to penetrate soft sediments). At this point, the slackening of the line activates the mechanism to close the jaws of the Ponar and Petersen grabs.

- (d) For the Ekman grab, send the messenger down to ‘trip’ the release mechanism.
- (e) Retrieve the sampler slowly to minimize the effect of turbulence (that might result in loss/disturbance of surface sediments).
- (f) Place a container (i.e., a shallow pan) beneath the sampler just as it breaks the surface of the water.

Note: If the jaws were not closed completely, the sample must be discarded. Discard the sample into a bucket if the second collection attempt is made from the same general area. Dump the unwanted sample only after the “real” sample has been successfully collected.

- (g) Place a sieve between the sampler and the pan and gently open the jaws and allow the sediments to empty into the sieve. The size of the sieve mesh will depend on the purpose of the study, but a common mesh size is 0.20 mm (200 µm). This size represents the practical lower limit for general study of benthic organisms. It is not as crucial to have small mesh size when the only analysis to be conducted is biomass.
- (h) Immediately record (in the field log book) observations regarding the appearance of the sediment (i.e., texture, colour, odour, presence of biota, presence of detritus).
- (i) Rinse the sieve with de-ionized or on-site water to remove as much sediment as possible.
- (j) Transfer the organisms to a pre-labeled sample bottle and preserve with 70% ethanol.

4.1.4.2 Core sampling

PROTOCOL

(boat sampling with a core sampler)

- (a) Open the valve and set the trigger mechanism (as per Figure 5). Ensure the rope is securely fastened to the corer and attach the dead end of the rope to the boat.
- (b) Lower the corer to approximately 5 m above an area of undisturbed sediments and then allow it to fall freely into the sediments.

- (c) Send the messenger down to release the trigger mechanism.
- (d) Carefully retrieve the sampler and place a stopper into the bottom opening **before** removing from the water to prevent loss of the sample.
- (e) Remove the liner from the corer and stopper the upper end.

Note: Once on shore, the sample can be treated as a bulk sample or it can be sectioned and the organisms separated from the sediment in strata.

- (f) For bulk samples all the sediment may be sieved as per the grab samples above. Otherwise, the sediment should be sectioned in regular intervals as it is extruded (record the thickness of each stratum the length of entire core). Each stratum may be sieved and its contents placed in pre-labeled sample bottles or, the unsieved sediments can be placed directly into pre-labeled sample bottles.
- (g) Preserve the samples with 70% ethanol.

Note: It is preferable to section the core as soon as possible after it is retrieved. As the sediment warms, it tends to expand in the core tube. With warming, decomposition gases are liberated at a much faster rate and if they bubble through the core, they will disturb the stratigraphy.

4.1.5 Macrophytes

Aquatic plants are collected for one of three purposes: first, biomass studies for the determination of how much plant material is present on an area or lake basis; second, tissue analyses for the detection of metals, pesticides and plant products; or third, taxonomic analyses as part of ecological or impact studies (permanent records of community structure over time) and to serve as reference specimens for the above two analyses. These reference specimens are a valuable scientific record and their collection and subsequent handling should be done with care so that much of the time and expense that has gone into their collection is not wasted. Reference specimens are stored in herbaria which provide permanent records of what was found and allow identifications to be re-verified if necessary. Even when the major thrust of the work is for biomass studies or tissue analyses, representative specimens must still be collected and saved as vouchers of the species that were analyzed. With respect to sampling for taxonomic purposes, Warrington (1994) documents techniques regarding the processing of individual taxa within each of the three groups of aquatic plants (floating, submergent, and emergent). This manual presents a general overview of the protocols for collecting aquatic plants for taxonomic purposes.

4.1.5.1 Taxonomy

Generally, the whole plant should be collected. Some groups cannot be identified to species without mature fruits or flowers. Large plants are pressed and mounted on a 30 by 40 cm white card that is dimensionally stable when wetted. Small plants like the duckweeds do not make satisfactory pressed and dried specimens. In this case, small screw cap vials make good collecting and preservation containers.

PROTOCOL

(small floating species collection)

- (a) Scoop a few individual plants into a pre-labeled vial.
- (b) Preserve the specimens in a solution of 70% ethanol, 25% water and 5% formalin.
- (c) These specimens must be submitted to a herbarium where they will be identified to species and stored for future reference.

PROTOCOL

(collection of large emergent or rigid plants for taxonomic purposes)

- (a) Field notes should be written directly on the card stock **before** you place the plants onto the card (you will not be able to write on the card once it is wet). The notes should be written in pencil in the lower right hand corner of the card where it will later be covered by the permanent label.
- (b) Collect an entire specimen and store it until conditions are appropriate to mount.

Note: Do not leave them out in the sun even briefly as they will wither very quickly and become useless as specimens. Emergent plants should not be submerged, but kept in a bag with a little water in the bottom to maintain high humidity. It is best to keep each species in its own bag and all the bags from one lake or site together in one large (garbage) bag.

- (c) To mount each specimen, lay the plant on the card stock with the roots in the bottom left corner (fold over the top if it is too tall to fit).

Note: Do not cover the label area in the bottom right corner.

- (d) Spread out leaves and flowers, turn some over so the bottoms can be seen, and try to make a neat and tidy specimen that covers the whole sheet.

Note: For small plants fill the sheet with more specimens from the same clump or clone, to show as much variability as possible.

- (e) For fruiting plants where the seeds may be shed on drying, collect the seeds into small paper or cellophane pouches and attach these pouches to the finished herbarium sheet.
- (f) After mounting the aquatic plant on the card stock, place a piece of heavy blotting paper on top of the specimen to help dry the plant quickly.
- (g) Wrap the card stock, plant, and blotter in a newsprint folder. The newsprint should be 30 by 90 cm in size and folded in half to form a folder in which the mounted plant is placed.
- (h) Once you have accumulated several of these wrapped packages (each containing one card stock/specimen), place them into a plant press with a piece of corrugated cardboard separating each package.

Note: The corrugations should run in the same direction so that air flow through the press is facilitated.

- (i) Drying should take place within several days to prevent fungal growth and rotting and to preserve colours and shapes as much as possible. If you will be in a laboratory or herbarium the same day, the plant presses may be dried in a proper plant drier or a forced draft oven at 40°C. In the field, use motel hot air registers, baseboard heaters, or hair dryers to move warm air through the corrugated cardboard. If the weather is dry, secure the plant press on the roof of the truck and allow air to blow through the corrugated cardboard as you drive from site to site. As the plants in the presses dry it will be necessary to retighten the presses periodically, at least daily, to maintain the pressure and hold the plants flat.
- (j) These specimens must be submitted to a herbarium where they will be identified to species and stored for future reference.

PROTOCOL

(collection of large submergent or non-rigid plants for taxonomic purposes)

- (a) Field notes should be written directly on the card stock **before** you place the plants onto the card (you will not be able to write on the card once it is wet). The notes should be written in pencil in the lower right hand corner of the card, where it will later be covered by the permanent label.
- (b) Collect an entire specimen and store it until conditions are appropriate to mount.

Note: Do not leave them out in the sun even briefly as they will wither very quickly and become useless as specimens. Keep them in a bag or bucket of water at all times until you are ready to press them. It is best to keep each species in its own bag and all the bags from one lake or site together in one large bag.

- (c) Since these plants are flaccid and clump together when removed from water, they need to be floated onto the card stock and arranged neatly to keep them from becoming a useless mat. Start by slowly lifting the bottom of the card stock out of the water at the root end and arranging and spreading the plant as you continue. Once a portion is out of the water, it will stay in place. Some, but not all, plants will allow a limited amount of rearranging once they are out of the water. Hold the card stock with one corner down and let most of the excess water drain off. Floating is best done in 36 by 50 cm photographic trays or directly in the lake from which the specimen was collected (it will be difficult in lakes if there is any wind or waves). A tray on a picnic table at a site with running water is an ideal mounting and pressing site.

Note: Do not take plants to a different lake to float them onto the card stock; you risk spreading weeds from lake to lake.

- (d) Continue as in (e) through (j) on the previous page.

4.1.5.2 Tissue Analysis

Plant tissues may be collected for analyses of metals, pesticides, nutrients, plant products, for dry weight/wet weight ratios, or for other laboratory analyses. In all cases an entire, intact, voucher specimen of each species should be collected and filed in a herbarium as a record of what was analyzed. The procedures outlined above under the section headed **Taxonomy** (4.1.5.1) should be followed.

For analyses of chemicals, it may be necessary to analyze distinct portions of the plant separately to determine where the material is localized in the plant (the portion to be collected will be outlined in the project design).

PROTOCOL

(collecting samples for tissue analysis)

- (a) Collect entire specimens and keep them submerged and covered until they can be processed (plants should never be allowed to desiccate).
- (b) Place each specimen in individual air tight bags (e.g., Zip Lock) or tissue cups or glass bottles (for analysis of trace organics). Ensure each is fully labeled. **Ensure the quantity of tissue and the types of container are appropriate for the analysis that will be conducted (see Appendix 2 of this chapter).**
- (c) Place the sample container in the required cooler for shipping (some analyses need to be frozen, therefore, these samples will be placed in a cooler containing a sufficient quantity of dry ice). **Always wear gloves when handling dry ice.**

4.1.5.3 Biomass Studies

Biomass studies, mass of plants per unit area, are not routine and are usually conducted as part of a research project. They are not performed as part of standard sampling programs. They often require the use of SCUBA to map out and harvest the designated area. Refer to Warrington (1994) for further information regarding biomass protocols.

4.1.6 Fish

The fish collecting and processing protocols outlined here are designed primarily for the purpose of analyzing tissues for levels of bioaccumulated substances. Since fish are high on the aquatic food chain, analyses of their tissues may provide valuable toxicological information about substances that are difficult to measure in ambient waters (such as mercury). For an extensive review of the common fish capture techniques refer to Chapter 9 of *Stream Survey Manual* (Koning, 1994), and *Fish Collection, Preservation, Measurement and Enumeration Manual* (Triton Environmental Consultants, 1994).

The various collection techniques discussed here are partially selective in terms of the species and size classes that each captures. Therefore, the particular method to be used will depend on the purpose of the study and will be outlined in the project design.

Always note date and time of each net set. It is recommended that depth and bottom type be recorded as well.

Note: For collecting fish samples, permits are necessary from the appropriate agencies.

4.1.6.1 Gill Nets

Gill nets are constructed of fine monofilament line suspended between a buoyant 'float line' and a non-buoyant 'lead line'. Nets may be all one mesh size or may be composed of different mesh sizes by joining a series of panels. Panels are generally 15 metres long. The mesh size of a panel is measured by pulling two opposing knots of a mesh-hole tight and measuring the distance. Mesh sizes generally range from 2.5 to 12.5 cm. The size of the mesh chosen will determine the size of the fish that will be caught.

There are two types of gill nets;

- (1) floating gill net - positive buoyancy for capturing surface-dwelling species, and
- (2) sinking gill net - negative buoyancy for capturing bottom-dwelling species.

The ends of the net are equipped with a bridle, tether lines, anchors, and buoys. Gill nets can either be set with an anchoring point on shore or with both ends anchored in open water (Figure 6).

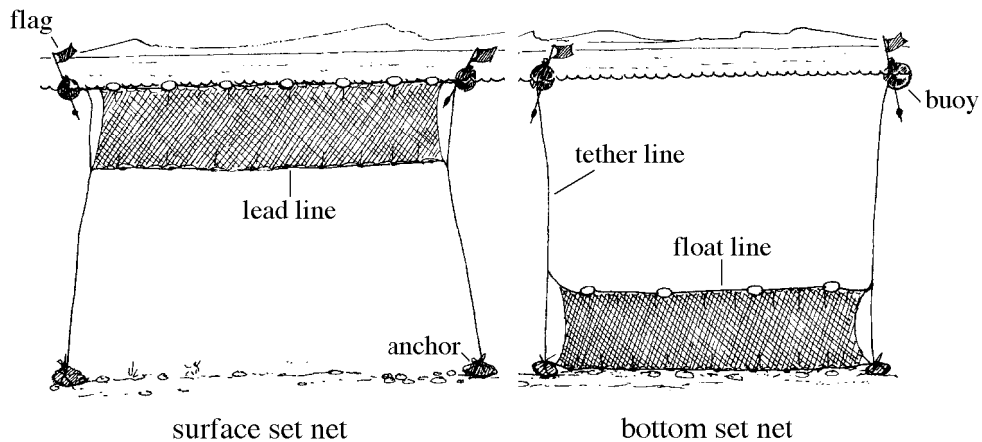
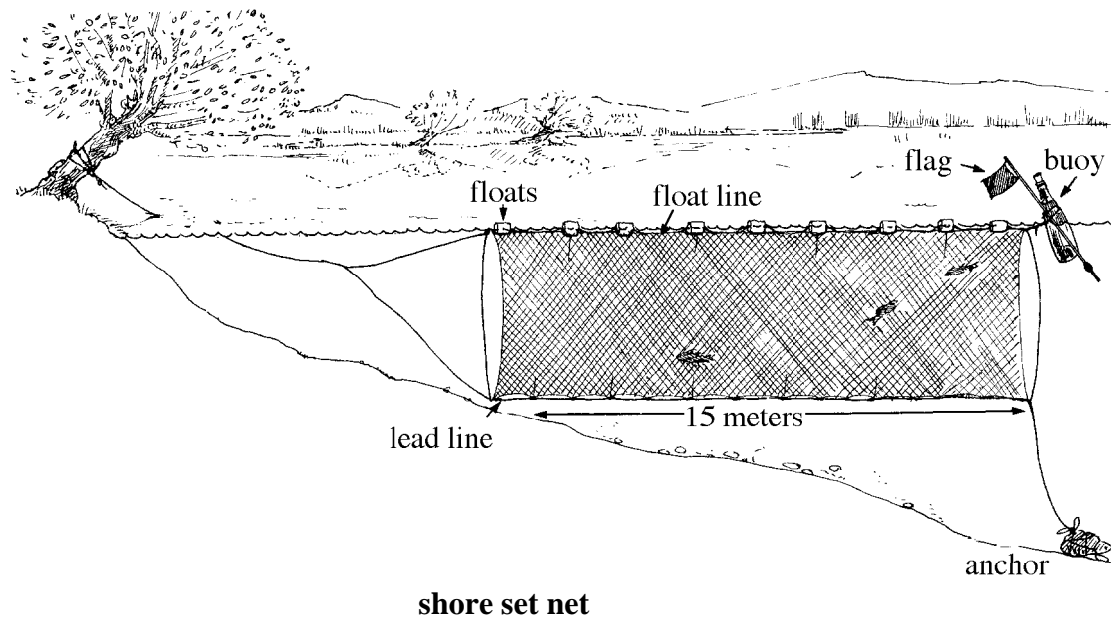

Figure 6. Various configurations for setting gill nets

PROTOCOL
(shore set gill net)

- (a) Select a location where there is both an ideal shore line anchoring point (e.g., a tree, a large rock, a dock etc.) and suitable near shore depth (so the net will not bunch on the bottom). Avoid setting the net near obstacles such as sunken stumps or logs that can entangle and rip nets.

- (b) Tie one end of the net to the shore anchor point with a tether line. Load the remainder of the net neatly into the boat.
- (c) One person then slowly rows in the direction that the net is intended to be set while the other person gently feeds the net out. (Hint: If the boat has protuberances, rivets, or sharp edges that will snag the net during deployment, it is advisable to cover these with a sheet of poly film.)
- (d) Once the net is at full extension, the anchor is lowered and the buoy deployed. **Attach labeled buoys to the float line at intervals of about 5 meters to warn boaters. Do not set a net near a swimming beach during swimming season, or leave a net unattended near boating lanes.**

Note: Ensure that the buoy is well flagged (and preferably labeled to identify the net as part of a BC Environment study).

- (e) While kneeling, grab the float line and pull the boat along the net to check for fish (if the boat is equipped with a motor, raise it to avoid entanglement with the net). Collect any fish encountered. If enough fish have been caught, reverse your path and retrieve the net. **(Hint: If there is any wind, it is advisable to retrieve the net against the wind to prevent the boat from drifting over and entangling the net.)**

Note: When retrieving the net (after having been set for an appropriate period of time), there is the option of hauling the net in and then removing the catch or, removing the catch first. (Hint: removing the fish before the net is in the boat poses fewer entanglement problems.)

- (f) Place captured fish in an ice-filled cooler. Label cooler for the site if there is more than one capture site.
- (g) Return to shore and process the fish as per section 4.1.6.4.

PROTOCOL

(gill net - open water)

- (a) Load the net neatly in the bow of the boat and proceed to the deployment site (established in the project design). Avoid sunken stumps and logs that can entangle and rip nets.

- (b) Anchor one end of the net securely. The person in the bow is responsible for deploying the net while the person in the stern controls the boat (reverse in the direction the net is to be set). **(Hint: try to set the net with the wind to prevent the boat from drifting over and entangling the net. Alternatively, you may set against the wind in reverse while under power.)**
- (c) Gently feed the net out and set the other anchor when the float line is taut. **Attach labeled buoys to the float line at intervals of about 5 meters to warn boaters . Do not set a net near a swimming beach during swimming season, or leave a net unattended near boating lanes.**

Note: Both buoys should be well flagged and labeled (indicating the net is part of a BC Environment study).

- (d) While kneeling, grab the float line and pull the boat along the net to check for fish (if the boat is equipped with a motor, raise it to avoid entanglement with the net). Collect any fish encountered. If enough fish have been caught, reverse your path and retrieve the net. **(Hint: If there is any wind, it is advisable to retrieve the net against the wind to prevent the boat from drifting over and entangling the net.)**

Note: When retrieving the net (after having been set for an appropriate period of time), there is the option of hauling the net in and then removing the catch or, removing the catch first. (Hint: removing the fish before the net is in the boat poses fewer entanglement problems.)

- (e) Place captured fish in an ice-filled cooler. Label cooler for the site if there is more than one capture site.
- (f) Return to shore and process the fish as per section 4.1.6.4

4.1.6.2 Beach Seining

A seine is a panel of netting pulled by bridles at each end (Figure 7). For many smaller seines, the bridle is attached to pulling poles or 'brails'. The upper line of the seine is equipped with floats and the lower with weights. Beach seines are effective only over shorelines and river bottoms that are free of obstacles such as logs, stumps or large boulders.

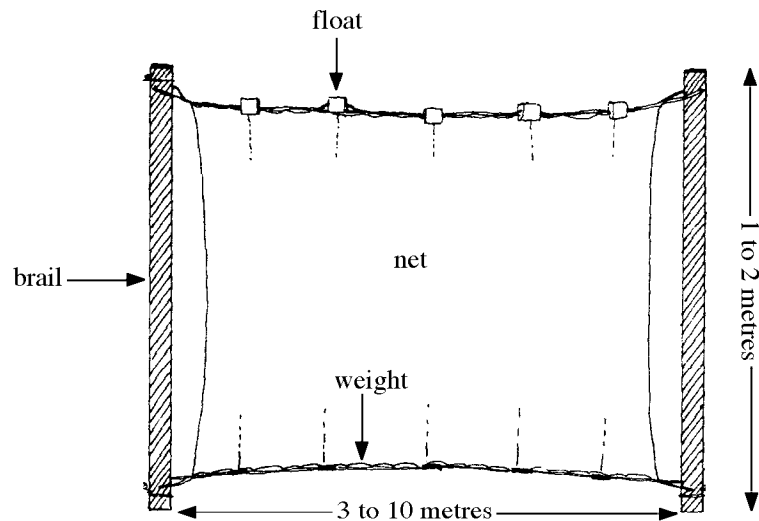

Figure 7. Seine net

PROTOCOL

(small seines - wading)

- (a) One person holds a brail securely against the bottom in ankle deep water while the second person wades directly out with the other brail. The first person remains stationary while the second pulls the seine to full extension and sweeps around pulling the net back in toward shore (all the while ensuring that the weighted line remains against the bottom).
- (b) Both people then pull the net up on shore where the fish are collected.
- (c) Process the fish as per section 4.1.6.4

PROTOCOL

(large seines - beach seine from boat)

- (a) Attach a length of rope to each bridle (the length will be the distance off shore from which the seine net will be pulled).
- (b) Tie an anchor to one of the ropes and brace the anchor on shore. Load the net into the bow of the boat.

- (c) The operator of the boat then reverses slowly directly away from shore while the person in the bow feeds the rope out.
- (d) Once the end of the rope is reached, the boat operator turns 90° and proceeds (in reverse) parallel to the beach while the person in the bow of the boat feeds out the net.
- (e) Once the end of the net is reached, the boat operator turns back towards shore while the person in the bow feeds out the rope.
- (f) The net is retrieved by pulling from both ends at the same rate (this ensures that the net is not pulled in at an oblique angle).
- (g) When the net is about 10 m from the beach, the two people then approach one another as they continue to haul it up on the beach where the fish are collected.
- (h) Process the fish as per section 4.1.6.4

4.1.6.3 Set Lines

A set line is a heavy line anchored at each end (one anchor having the flag line). It has regularly spaced leaders with hooks. Set lines can be used in situations where the use of nets are not appropriate (such as very deep or fast flowing waters).

PROTOCOL

(for set lines)

- (a) Bait each hook and load the line carefully into the bow of the boat. Carefully lower the end of the line (anchor without a buoy or marker line).
- (b) The boat operator then slowly reverses in the direction the line is to be set while the person in the bow carefully feeds out the line (**use extreme caution with the hooks**).

Note: **Never wrap a line around your wrist, arm, or leg due to danger of the line snagging.**

- (c) Once the end of the line is reached (the other anchor is encountered), the anchor is lowered using the flag (buoy) line and the boat operator reverses slowly to ensure that the line is taut.

- (d) Ensure that the buoy is labeled indicating a BC Environment study.
- (e) To retrieve the line (generally the next day - outlined in the project design) haul up the flag line until the first hook is reached, then slowly move in the direction that the line is set as the remaining hooks are hauled into the boat.
- (f) Return to shore and process the fish as per section 4.1.6.4

4.1.6.4 Processing Fish Tissues

PROTOCOL

(preparation of fish tissue for analysis of **trace metals**)

- (a) Each specimen should be identified, weighed, measured, and scale samples taken for aging before dissection (see Triton, 1994). Sex should be determined after dissection and maturity commented on if possible (i.e., degree of egg or sperm development).
- (b) Wipe specimen clean of mucous and foreign matter with a 4% nitric acid/de-ionized water solution prior to dissection.

Note: Dissect specimens on cleaned glass or plastic surfaces only.

- (c) When removing a block of tissue from the specimen, the cutting instrument (plastic or stainless steel knife) should be wiped clean after each incision using a paper towel soaked with de-ionized water. Use a new paper towel for each specimen dissected. The preferred location on the fish for a sample of muscle tissue is the upper part of the side behind the dorsal fin.

Note: Care should be taken not to cut into the digestive tract during dissection. If the target fish are small, composite tissue samples may be required (this will be identified in the project design).

- (d) Remove a minimum of 100 g of muscle tissue and place in a pre-labeled tissue cup (acid washed, leak-proof plastic containers available from the issuing laboratory). Remove the liver and place in a pre-labeled tissue cup.

Note: Muscle tissue samples should be free of skin and bones. Liver samples must exclude the gall bladder.

- (e) Immediately place each tissue cup in a cooler containing ice packs.

- (f) The glass or plastic dissecting board should be wiped clean with the 4% nitric acid/de-ionized water solution before proceeding to the next specimen. The acid should be certified pure and a QC check made of the working solution for contamination. An alternative is to use solvent washed aluminum foil as a disposable clean surface (replace after each specimen).

PROTOCOL

(preparation of fish tissue for analysis of **organic contaminants**)

- (a) Each specimen should be identified, weighed, measured, and scale samples taken for aging before dissection. Gender should be determined after dissection, and maturity commented on, if possible.
- (b) Wipe specimen clean of mucous and foreign matter with de-ionized water (stored in a glass container) prior to dissection.

Note: Dissect specimens on glass or stainless steel surfaces only. At no time should the sample come into contact with plastic.

- (c) When removing a block of tissue from the specimen, the pre-cleaned (solvent washed, heat treated) cutting instrument should be wiped clean after each incision using a paper towel soaked with de-ionized water. Use a new towel for each specimen dissected.

Note: Care should be taken not to cut into the digestive tract during dissection.

- (d) Remove a minimum of 50 g (see Appendix 2 of this chapter) of muscle tissue and place in a pre-labeled glass container (acetone washed, heat treated at 400°C - available from the issuing laboratory). Remove the liver and place in a pre-labeled glass container.

Note: Muscle tissue samples should be free of skin and bones. Liver samples must exclude the gall bladder.

- (e) Immediately place each sample container into a resealable bag (e.g., Zip Lock) and then in a cooler with ice packs (or dry ice if sample is to be analyzed for volatile or semivolatile organics).
- (f) The dissection board should be wiped clean with de-ionized water before proceeding to the next specimen.

4.2 River/Stream Biological Samples

In some instances, the protocols for collecting biological specimens in rivers are similar to those used for sampling in lakes. But in the case of benthic fauna and fish, the collection techniques are considerably different. The following are the protocols for the collection of biological samples from flowing waters.

4.2.1 Bacteria

As is the case for lakes, bacteria are collected as grab samples and immediately cooled to 4°C to minimize metabolic activity (growth/reproduction) until they can be analyzed by the laboratory.

Wherever practical, samples should be collected at mid-stream rather than near-shore. Samples collected from mid-stream reduce the possibilities of contamination (i.e., shore effects - back eddies, seepage from near shore soils, etc.). The most important issue to consider when deciding where the sample should be collected from is **SAFETY**. If the flow is sufficiently slow that the collector can wade into the stream without risk, then the sample can be collected at a depth that does not pose a threat (discretion is the key - **never wade into water that appears deep or fast flowing**). When conditions dictate that the sample be taken from the stream bank, deviations from the standard protocol should be accurately documented in the field log book and transferred to the database as soon as possible.

PROTOCOL (for wading into flow)

- (a) Obtain a labeled, sterile 250 mL bottle and wade into the river downstream from the point at which you will collect the sample. Wade upstream to the sample site. This ensures that you will not disturb sediments upstream from the sample point.
- (b) Stand perpendicular to the flow and face upstream.
- (c) Remove the lid and hold it aside without allowing anything to touch the inner surface.
- (d) With your other hand, grasp the bottle well below the neck. Plunge it beneath the surface with the opening facing directly down, then immediately orient the bottle into the current.

- (e) Once the bottle is full, remove it from the water by forcing it forward (into the current) and upwards. Pour out some water to ensure there is an air space.
- (f) Replace the cap immediately.
- (g) Return to shore and place the sample in a cooler with sufficient ice packs (twice the volume of ice as the sample in summer, same volume in winter).

PROTOCOL

(for sampling from the stream bank)

(when the current is too strong, water is too deep, or ice is too thin)

- (a) Secure yourself to a solid object on shore (with a safety harness and line if necessary).
- (b) Remove lid from a labeled, sterile 250 mL bottle and place into a clean resealable bag (e.g., Zip Lock).
- (c) Hold the bottle well below the neck.
- (d) Reach out (arm length only) and plunge the bottle under the water and immediately orient it into the current.
- (e) When the bottle is full, pull it up through the water while forcing into the current. Pour some water out so as to leave an air space.
- (f) Immediately recap the bottle.
- (g) Place the sample in a cooler with sufficient ice packs (twice the volume of ice as the sample in summer, same volume in winter).

Note: If conditions are such that sampling from a bridge is an option, refer to the chapter, Ambient Freshwater and Effluent Sampling, 4.2.2, for the protocol.

4.2.2 Periphyton

Periphyton are defined as attached species of microflora (algae) and are primarily found on hard, immobile surfaces such as large stones (cobbles, boulders) and on aquatic plants. Analysis of periphyton communities, particularly for the purpose of biomass calculations, involves collecting the algae from a known surface area. To do so, the following pieces of equipment are required:

- A piece of equipment to outline a known surface area and contain the removed biomass - for example, a toilet bowl plunger that has had the handle insertion hole cut larger. The diameter of the hole is known, therefore the surface area of the exposed rock below the hole is known. A rim of neoprene is glued around the hole to prevent water and algae from escaping when collecting the sample. It is also possible to use a template if the algal mass is gelatinous or coherent enough to be picked off the growing surface. A template is a piece of flexible rubber or plastic with a square or round hole cut in it to define the area to be scraped.
- A water bottle (squirt bottle) containing de-ionized water
- A tooth brush (to scrape the algae free from the rock)
- A turkey baster (to transfer the sample from the scraping cup to the sample bottle)
- Pre-labeled sample bottles
- Ethanol

PROTOCOL (natural substrate)

- (a) Choose a location of fairly uniform substrate over wetted width. Try to work in upstream but random direction. Select rocks that are relatively flat and large enough to accommodate at least three scraping cups. Unless the project design states that rocks with the most dense growth are to be sampled, the sample collector should select the rocks randomly. To do so, the collector should not specifically look for an area from which to sample, but instead should wade into the water and stop without regard for apparent algal concentration and then grab the first rock that is suitable for scraping. Return to shore with the selected rock and repeat the process until 3 or 4 rocks are collected. **Don't attempt to lift rocks that are too heavy and don't enter water that may pose a threat to your safety. Watch your footing while returning to shore with the rock.**
- (b) Hold the scraping cup firmly over a selected patch on a rock. Squirt some de-ionized water into the cup. With the tooth brush, scrape the algae (within the cup) off the rock. Each new algal patch that is scraped can be referred to as a disc.

- (c) Transfer the water-algae mixture to a pre-labeled bottle (a turkey baster with the tip cut off works very well as the transfer tool). Do not remove the cup yet.
- (d) Squirt some fresh de-ionized water into the cup, re-scrape and collect the rinsate. At this point you have collected one disc. Collect and composite more discs until you have transferred a sufficient quantity of algae to the sample bottle [see (e)].
- (e) If algal density is low or patchy, collect at least five discs from each rock. If algal density is high or homogeneous, then take fewer discs per rock, but ensure that you use at least five rocks to characterize the periphyton at the site. **Always record the total number of discs collected.**
- (f) If the sample is to be analyzed for biomass, place the bottle in a black garbage bag and then immediately into a cooler that contains a sufficient quantity of ice packs (twice the volume of ice as the total sample when sampling in summer, equal volumes when sampling in winter).
- (g) For measurement of biomass, the samples are prepared for chlorophyll analysis by filtering the sample onto a membrane filter (0.45 or 1.0 μ pore size), then folding this filter and placing it inside a larger (8 to 10 cm.) Whatman type paper filter labeled (date, site, area scraped), then clipped with a plastic paperclip and placed into a jar with desiccant and placed in the freezer or in a cold cooler for shipment to the lab.

Note: In washing and transferring the sample, keep the volume of water used to a minimum. Filtering periphyton samples can be very difficult due to suspended sediments that generally accompany the periphyton.

It may be necessary to use a larger pore size filter than for phytoplankton (typically 0.45 μ). Periphyton cells are typically much larger than phytoplankton. An analysis of the filtrate from the periphyton sample will indicate if significant biomass is passing through the larger filter size chosen.

- (h) If the samples are to be analyzed for taxonomy (only two or three discs are required), then the sample must be preserved with Lugol's solution. Use at least 1 mL of Lugol's per 250 mL of sample (with heavy biomass, more preservative is needed). No filtration is required. Tip once or twice to mix preservative and sample water.

- (i) Different conditions or circumstances may require different methods than described here. Other methods are acceptable as long as they are described and documented and approved by Ministry authority. For example, where heavy periphyton growth occurs, a method for sampling heavy growth could use a template disc to define a sampling area and scrape the area around it, then remove the disc of periphyton with a scalpel. This method reduces the volume of wash water that must be used and potential clogging of filters.

4.2.3 Benthic Fauna (macro-invertebrates)

Samplers used for the collection of invertebrates in the shallow portions (<one metre deep) of rivers or streams fall into two categories: those sampling natural substrates, and those using artificial substrates. Two of the more common samplers used for natural substrates are the Surber and Hess samplers (Figure 8). The Drift net sampler can also be used to collect the emerging or drifting invertebrate stages.

Natural Substrate. The advantage of these types of sampler is that the sample reflects the natural community of the stream. The disadvantages are that such samples have a very high variability and many samples need to be taken to characterize the benthic community. The large number of samples necessary generally means relatively high cost.

The recommended mesh size is 210 μm (microns) for most samples. In some specialized studies a different mesh size may be appropriate. It may be appropriate to collect the samples using a 210 μm mesh size but to do a preliminary sieving at 500 μ . The sample material retained on the 210 μm mesh is stored to be processed later if the program design calls for it.

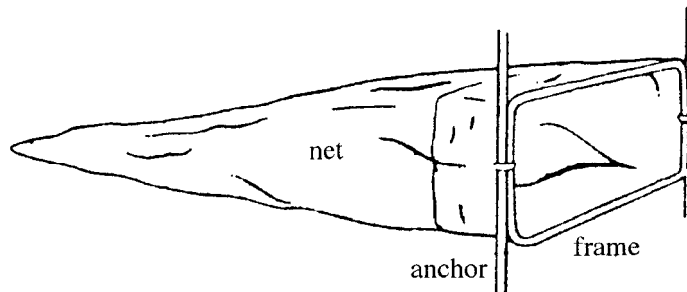

Drift net sampler

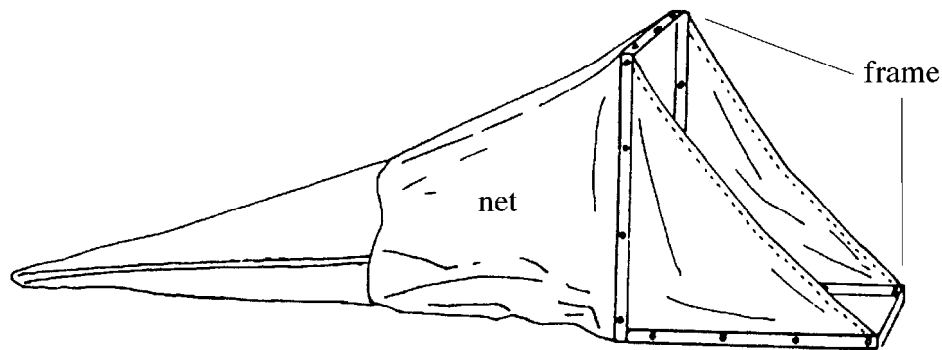

Surber sampler

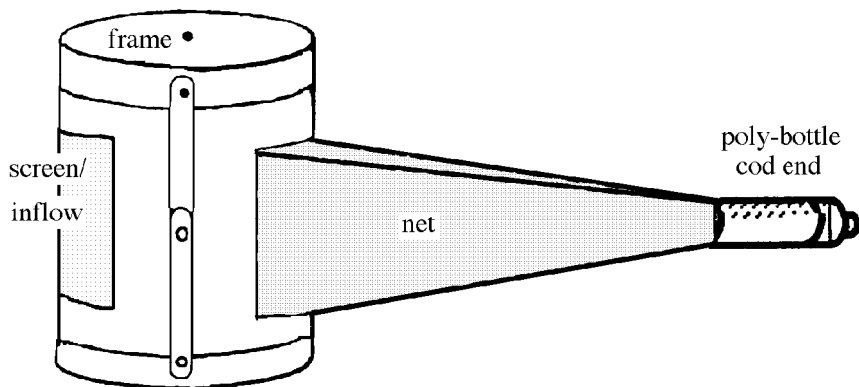

Hess sampler

Figure 8. Common benthic macro-invertebrate samplers

4.2.3.1 Surber Sampler

The Surber sampler consists of two interlocking frames that support a capturing net. One frame outlines the area of stream bed to be sampled while the other supports the net. The sampler is intended for use in shallow (30 cm or less) flowing waters. Use A1 tent pegs (hooked) to anchor surber in fast moving water. Repetitive sampling should be timed (i.e., 5 minutes each for more uniform sampling).

PROTOCOL
(Surber sampler)

- (a) Choose a wetted width location where substrate is fairly uniform. Provide a description of general habitat (e.g., is this a run, pool or riffle section, etc.). Position the sampler securely at a random location on the stream bottom parallel to water flow with the net portion down-stream. The mesh size of the net should be compatible with the goal of the program.

Note: Take care not to disturb the substrate upstream from the sampler.

- (b) Carefully turn over and lightly rub all rocks and large stones that lie within the frame. This process dislodges organisms that are clinging to the stones. Examine each large stone for organisms, including larval or pupal cases, that may be clinging to the stone before discarding (downstream or to the side of the sampler). In order to maintain comparability between stations, a limit on time spent on handling and rubbing the substrate should be set (5 minutes recommended).
- (c) Stir remaining gravel with your hands to a depth of 5 to 10 cm.
- (d) Move the sampler **upstream** to a new randomly selected patch of stream bottom and repeat steps (a) through (c). Continue this process until five patches of stream bottom have been sampled, each upstream from the last. This creates a composite of the five samples. The total area sampled will depend on the size of the sampler (x 5) and should be calculated and recorded in the **field log book**.
- (e) Return to shore and carefully invert the net into a shallow pan containing stream water. Ensure all invertebrates are rinsed from the net into the pan.
- (f) Transfer the organisms into a pre-labeled plastic sample bottle and preserve with 70% ethanol. **Rinse sample net after each use.**

4.2.3.2 Hess Sampler

The Hess sampler is a metal cylinder with a screened opening on one side and an opposite opening with a net attached (Figure 8). The sample collector places the Hess sampler in the stream with the screen oriented into the current and the net trailing behind. The water is able to flow freely through the sampler and out through the net. With a known radius, the stream bed area that is sampled is easily calculated. This value must be recorded in the **field log book**.

PROTOCOL
(Hess sampler)

- (a) Position the frame securely on the stream bottom. Ensure the screened opening is facing into the current and the net portion is trailing down-stream. Hold the sampler in position by applying pressure with your knees.

Note: Take care not to disturb the substrate upstream from the sampler.

- (b) Reach into the cylinder and carefully turn over and lightly rub all rocks and large stones. This process dislodges organisms that are clinging to the stones and washes them into the net. Examine each stone for organisms, including larval or pupal cases, that may be clinging to it before discarding it outside of the cylinder. In order to maintain consistency between samples, a standard time should be assigned to sampling each site (5 minutes recommended).
- (c) Stir remaining gravel with your hands to a depth of 5 to 10 cm.
- (d) Move the sampler **upstream** to a new patch of stream bottom and repeat steps (a) through (c). Continue this process until five patches of stream bottom have been sampled, each upstream from the last. This creates a composite sample of the five areas.
- (e) Return to shore and carefully wash the contents of the net into the cod-end then transfer to a shallow pan. Ensure all invertebrates are rinsed into the pan.
- (f) Transfer the organisms into a pre-labeled sample bottle and preserve with 70% ethanol. **Rinse sample net after each use.**

4.2.3.3 Drift Net Sampler

Drift net samplers are designed to be anchored in flowing water to capture macro-invertebrates that have migrated or have been dislodged from the bottom surfaces into the current. They are limited to use in small, shallow streams. Ideally, drift nets should span the entire width of the stream that is being sampled. Several nets can be placed across the stream channel to capture all drift organisms and to measure spatial variation in the drift.

PROTOCOL
(Drift Net sampler)

- (a) Anchor drift nets in water sufficiently shallow that they will extend above the water surface. Set drift net samples for the time specified by the project design (the length of time is designed to collect a representative sample, but not so long that flow through the nets becomes impaired by clogging from captured particulate matter).
- (b) Transfer the organisms into pre-labeled sample bottles.
- (c) Preserve with 70% ethanol and place in cooler. Initial fixation may be done with 10% formalin.
- (d) Record time, area of net opening, stream discharge per unit time (see the Ambient Fresh Water and Effluent Sampling chapter, 6.7), and volume of water filtered in the **field log book**.

Artificial substrates. The above techniques sample the benthos directly from the natural substrate. Another technique is to use artificial substrate and to place it in the stream so it is colonized by the organisms in the stream then removed later and the community analyzed. These types of samplers are best suited for upstream/downstream studies or studies designed to test for changes over time. They do not necessarily provide a representative sample of the actual community which is living in the stream.

There are advantages and disadvantages to artificial substrates.

Advantages:

- Allow collection of samples from locations that can't be sampled because of substrate or depth
- Reduced variability
- Non-destructive sampling of a location
- Flexibility in sampling design

Disadvantages:

- Colonization rates differ from site to site
- Species in sampler may be different than stream bottom
- Long incubation/exposure times (6-10 weeks)
- Vulnerability of samplers to vandalism

The most frequently used artificial substrate sampler is the "barbecue basket" sampler. The basket sampler is fabricated by filling the basket (available in a number of variations from hardware stores) with gravel (2.5 to 7.5 cm diameter) that is then placed in the stream bottom. The substrate becomes colonized and is removed after some predetermined length of time.

PROTOCOL
(basket sampler)

- (a) Place the basket sampler in the stream and anchor if necessary. Leave in place for the necessary colonization time.
- (b) When the samplers are removed, take particular care not to dislodge organisms from the sampler. A general technique is to carefully place the basket sampler in a plastic bag underneath the water before it is lifted out.
- (c) Record time, any site related data such as flow, temperature and pH (see the Ambient Freshwater and Effluent Sampling chapter), and data about the appearance and condition of the basket sampler in the **field log book**.
- (d) In the lab, remove the animals from the sampler by carefully washing each rock into a sieve. Transfer the organisms into pre-labeled sample bottles. Preserve with 70% ethanol and place in cooler. Initial fixation may be done with 10% formalin before transfer to ethanol for longer term storage.

4.2.4 Macrophytes

Due to the similarity in the techniques, refer to 4.1.5 (in lake sampling) for the protocols for collecting and processing macrophytes in rivers.

4.2.5 Fish

All methods of collecting fish specimens in flowing waters can be dangerous (i.e., while nets or lines are being deployed in a current there is the possibility of becoming entangled or hooked). Consequently, it is an absolute requirement that, when sampling for fish, there must be at least one person who has extensive experience with the operation of a boat and the use of fishing equipment in flowing waters.

Record time and date of set and retrieval to compute catch effort.

4.2.5.1 Gill Nets

When setting gill nets in flowing waters, two factors must be considered: the flow must be sufficiently slow that the net does not get dragged downstream, and the river must be deep enough that the net does not bunch on the bottom. Consequently, this technique is limited to large rivers in reaches where the current is very low.

PROTOCOL (shore set net)

- (a) Select a location where there is an ideal shore line anchoring point (e.g., a tree, a large rock, a dock, etc.), suitable river depth, and slow current. Avoid setting the net near obstacles such as sunken stumps or logs that can entangle or tear nets. One good location for migrating fish is at a sharp bend or point
- (b) Tie one end of the net to the shore anchor point. Load the remainder of the net neatly into the boat.
- (c) The person in the bow gently plays the net out while the boat is allowed to drift out with the current (the tension on the float line keeps the boat under control). The boat operator (**who must be experienced with boat operation and safety in flowing waters**) should idle the boat in neutral and must remain ready to power up the motor or control direction if the conditions dictate.
- (d) Once the net is at full extension, the boat operator idles into the current so that the boat remains stationary while the other person lowers the anchor and deploys the buoy.

Note: Ensure that the buoy is well flagged (and preferably labeled to identify the net as part of a BC Environment study). Do not set the net near a swimming beach during swimming season or in boating channels.

- (e) While kneeling in the bow of the boat, grab the float line and pull the boat along the net into the current (if the boat is equipped with a motor, haul it up to avoid entanglement). Collect any fish encountered. Return to the end of the net and haul it in.

Note: When retrieving the net (after having been set for an appropriate period of time) there is the option of hauling the net in and then removing the catch or, removing the catch first. (Hint: removing the fish before the net is in the boat poses fewer entanglement problems).

- (f) Euthanize the captured fish and store them in an ice-filled cooler. Label the cooler for the site if there is more than one capture site.
- (g) Process the fish as per 4.1.6.4.

4.2.5.2 Seining

In larger rivers where there are areas of slow flow, beach seining as described for lakes is possible. Otherwise, seine nets can be used in shallow creeks to capture small fish.

PROTOCOL

(beach seining in large rivers - wading)

- (a) One person holds a brail securely against the bottom in ankle deep water while the second person wades out with the other brail. The first person remains stationary while the second pulls the seine to full extension and sweeps around into the current then pulls the net back in toward shore (all the while ensuring that the weighted line remains against the bottom).
- (b) Both people then pull the net up on shore where the fish are collected.
- (c) Process the fish as per 4.1.6.4.

PROTOCOL

(creek seining)

- (a) Position the net across the width of the stream.
- (b) One person holds it securely in place while the other person enters the creek upstream and moves towards the net while kicking up rocks.
- (c) Each person then grabs a brail and lifts the net while swinging it into the current and clear of the water in a scoop-like fashion.
- (d) Process the fish as per 4.1.6.4.

Note: If the fish are too small to process in the field, they may have to be submitted as whole specimens (outlined in the project design). Non-target species should be enumerated, measured and sexed and returned to the water.

4.2.5.3 Set Lines

A set line is an ideal option in faster flowing waters where nets are not feasible. They are best set in the main current.

PROTOCOL

(Set lines)

- (a) Bait each hook and load the line carefully into the bow of the boat.
- (b) The boat operator then orients the boat into the current and powers up to maintain a stationary position. The person in the bow carefully deploys the anchor.
- (c) The boat operator then powers down such that the boat starts to move slowly backwards with the current while the other person plays out the line (**use extreme caution with the hooks**). **The boat operator must be ready to power up to relieve tension on the line should a problem arise.**

Note: Never wrap a line around your wrist, arm, or leg due to danger of the line snagging.
- (d) Once the end of the line is reached (the other anchor is encountered), the anchor is lowered using the flag (buoy) line.
- (e) Ensure that the buoy is labeled indicating a BC Environment study.
- (f) To retrieve the line (generally the next day - outlined in the project design), the person on the bow hauls up the flag line until the first hook is reached, then the boat operator slowly powers up into the current while the remainder of the line is hauled up.
- (g) Process the fish as per 4.1.6.4.

4.2.5.4 Electrofishing

Electrofishing is potentially dangerous, consequently, BC Environment requires that all government employees be certified before using this technique (Electrofishing Policy and Procedures Course).

Electrofishing is an ideal tool in smaller streams where the bottom is uneven or there are obstructions that make conventional collecting techniques difficult. It can be used either to stun the fish so that they can be collected with a dip net, or, to scare the fish ahead of the electrical field into a net (seine) that spans the width of the stream.

PROTOCOL
(Electrofishing)

Note: All members of the sampling team must be certified through the Electrofishing Policy and Procedures Course.

- (a) Follow the manufacture's directions for storage, transport, operation, and maintenance of the specific shocking device available to you.
- (b) Set a net the width of the creek downstream from where you begin electrofishing.
- (c) Work toward the net until a sufficient number of fish have been trapped.
- (d) Collect and process as per 4.1.6.4.

Note: If the fish are too small to process in the field, they may have to be submitted as whole specimens (outlined in the project design).

- (e) Note effort required to collect fish (as an index of catch per unit effort) and the instrument settings for the stream conditions.
- (f) For the recorded notes, approximate fishing area (i.e., length and width of stream).

5. Shipping

The day's sampling schedule must be designed to ensure that the samples arrive at the shipping agency's terminal well before the end of business hours. Since some variables have very limited hold times (Appendices 2 and 3 of this chapter), every effort must be made to avoid delays in shipping. The following is the procedure to be followed to maintain the integrity of the samples during transit.

Note: Generally, all samples, except those for bacteriological and taxonomic identification, should be securely packed in large coolers. Bacteriological samples are typically packed in a smaller cooler. Taxonomy samples should be preserved and do not require cooling during shipment.

PROTOCOL
(shipping)

Note: Ice packs should be used as opposed to loose ice or bagged ice. When loose ice melts, the contents of the cooler are free to shift, potentially allowing contamination of samples with melted ice water and/or breakage of glass bottles.

- (a) Pack the samples upright in the cooler with at least 1 (winter) to 2 (spring, summer, fall) times as much ice as the total volume of the samples. Ensure that the glass containers are separated from each other by ice packs, plastic bottles or clean packing material to prevent them from shifting, falling over and/or breaking. For some analyses, tissues need to be hard frozen - dry ice is needed.
- (b) Complete the laboratory requisition forms, enclose them in a sealed plastic bag, and place them in the cooler on top of the samples. The recommended minimum information that should accompany samples to the laboratory (on each requisition form) includes:
 - Name of the source,
 - Site name
 - EMS site numbers
 - Date and time of collection
 - Name of collector
 - Field measurements
 - Comments on sample appearance, weather conditions, and any other observations that may assist in interpreting data.
- (c) Seal the cooler with heavy duty packing tape to reduce the possibility of it accidentally opening and to prevent tampering with the samples. Coolers arriving at the laboratory with torn or absent tape alert the lab staff that tampering might have occurred during transit.
- (d) Attach a label prominently displaying the destination.

6. Sources of Further Information

American Public Health Association, American Water Works Association, Water Environment Federation. 1992. Standard Methods for the Examination of Water and Wastewater. 18th edition. *Edited by:* Greenberg, A.E., Clesceri, L.S., Eaton, A.D., and Franson, M.A.H. *Published By:* American Public Health Association.

- Clark, M.J.R., Shera, W.P. (*Editors*). 1985. Methods for Aquatic Data Collection in British Columbia: A Catalogue. BC Ministry of Environment, Victoria, BC.
- EVS Consultants. 1993. Guidelines for Monitoring Benthos in Freshwater Environments. Prepared for Environment Canada, North Vancouver. 81 p.
- Kerans, B.L., J.R. Karr, and S.A. Ahlstedt. 1992. Aquatic invertebrate assemblages: Spatial and temporal differences among sampling protocols. *J. North Am. Benth. Soc.* 11: 377-390.
- Klemm, D.J., P.A. Lewis, F. Fulk, and J.M. Lazorchak. 1990. Macroinvertebrate field and laboratory methods for evaluating the biological integrity of surface waters. USEPA. EPA/600/4-90/030. 246 p.
- Horner, R., Bloom, N., Crecelius E., and Brown, S. 1991. Recommended Protocols for Measuring Conventional Water Quality Variables and Metals in Fresh Water of the Puget Sound Region. *In: Puget Sound Estuary Program, Recommended Guidelines for Measuring Selected Environmental Variables in Puget Sound*.
- Koning, W. 1994. Stream Survey Manual. Ministry of Environment, Lands and Parks. Government of British Columbia. Draft.
- Lenat, D.R. 1988. Water quality assessment of streams using a qualitative collection method for benthic macroinvertebrates. *J. North Am. Benth. Soc.* 7:222-223.
- McDonald, L.E. 1991. Guidelines for sampling benthic invertebrates in streams. BC Environment, Environmental Protection. Draft 4, 7p.
- Peden, A.E. 1976. Collecting and Preserving Fishes. Museum Methods Manual 3. British Columbia Provincial Museum.
- Rosenberg, D.M. 1978. Practical sampling of freshwater macrozoobenthos: A bibliography of useful texts, reviews, and recent papers. Fisheries and Marine Service, Western Region, Technical Report 790 18p.
- Triton Environmental Consultants. 1993. Fish Collection, Preservation, Measurement and Enumeration Manual. First Draft Edition. Prepared for AITF of the Resources Inventory Committee. 97 p.
- U.S. Geological Survey. 1993a. Guidelines for the processing and quality assurance of benthic invertebrate samples collected as part of the National Water-Quality Assessment Program. Open-File Report 93-407.

- U.S. Geological Survey. 1993b. Methods for sampling fish communities as part of the National Water-Quality Assessment Program. Open-File report 93-104
- U.S. Geological Survey. 1993c. Methods for collecting benthic invertebrates as part of the National Water-Quality Assessment Program. Open-file Report 93-406.
- U.S. Geological Survey. 1993d. Methods for collecting algal samples as part of the National Water-Quality Assessment Program. Open-file Report 93-409.
- U.S. Geological Survey. 1993e. Methods for characterizing stream habitat as part of the National Water-Quality Assessment Program. Open-file Report 93-408.
- Warrington, P. 1994. Collecting and Preserving Aquatic Plants. Water Quality Branch. Environmental Protection Department. Ministry of Environment, Lands and Parks. Government of British Columbia.
- Wetzel, R.G., and Likens, G.E. 1991. Limnological Analysis. Second edition. Springer - Verlag, New York.

7. Revision History

- October 11, 2013: This section republished without change. Appendix 2 - Sample containers, StorageTM, Preservation and Holding Times and Appendix 3 - Laboratory Sample Container, Preservation, and Hold Times for Fresh Water Biological Sampling updated.
- February 28, 2001: This section republished without change. Note added to Appendix 2 requiring use of glass or TeflonTM containers for samples to be analyzed for mercury
- November 1996: Initial publication.

Appendix 1 Generic Field Checklist

(including water, sediments, biota and effluents)

General:

Log Books _____	Pencils _____
Cooler (with ice packs) _____	Felt Markers (waterproof) _____
Rope _____	Tape _____
Camera (film) _____	Requisition forms _____
Way bills _____	Shipping labels _____
De-ionized water (4L) _____	Squirt bottle _____
Resealable bags _____	Ice packs _____ Dry Ice _____

Labeled Sample Bottles:

General chemistry (1 L) # _____	General chemistry (2 L) # _____
Dissolved Metals # _____	Total Metals # _____
Total Organic Carbon # _____	Low-level nutrients # _____
Coliforms # _____	Sediments # _____
Zooplankton # _____	Phytoplankton # _____
Periphyton # _____	Invertebrates # _____
Tissue cups # _____	Macrophytes _____
Extras - two of each	

Sampling Equipment (clean, in working order, batteries charged):

DO Sampler (BOD bottle, Winkler reagents) _____	
Thermometer _____	DO meter _____
pH meter _____	Conductivity meter _____
Hydrolab _____	Secchi disc _____
Van Dorn, rope _____	Through Ice Sampler _____
Auger (bit sharpened, skimmer) _____	Spare probe membranes (repair kit) _____
Sediment grab _____	Sediment corer _____
Sieves _____	Zooplankton tow nets _____
Benthic invertebrate sampler (Hess, drift net, Surber) _____	
Periphyton kit (cup, denture brush, baster) _____	
Macrophyte sample kit (buckets, garbage bags, float tray, plant press, blot paper, herbarium sheets, newsprint, corrugated cardboard) _____	
Electrofishing equipment _____	Fish nets _____

Filtration and Preservation Equipment:

Filter Pots _____
Tweezers _____
Preservative Vials _____
70% ethanol _____
Lugol's solution _____
Syringe(s), Hose _____
0.45 μ Sartorius filter papers _____
Disposal Container (for used vials) _____
Formalin _____
Magnesium carbonate _____

Boat Equipment:

Canoe (or boat) _____
Motor _____
Life jackets _____
Anchor _____
Paddles _____
Fuel _____
Rope _____
Tool kit _____

Personal Gear:

Lunch _____
Rain gear _____
Waders (hip, chest) _____
Flash light _____
Survival suit _____
Gum boots _____
Sun screen _____

Safety:

WHMIS guidelines _____
Goggles (or safety glasses) _____
First Aid Kit _____
Rubber gloves _____

Appendix 2 Lab Sample Container, Preservation, and Hold Times for Sediments and Tissues

TYPE OF ANALYSIS	STORAGE TEMP⁽³⁾	CONTAINER TYPE	PRESERVATION	MAXIMUM HOLD TIME⁽⁴⁾
SEDIMENTS, TISSUES				
INORGANIC				
Bromide / Chloride / Fluoride	no req.	P, G	none	unlimited
Cyanide (WAD / SAD)	≤6°C	P, G	store in dark, field moist	14 d
Hexavalent Chromium	≤6°C	P, G	store field moist	30 / 7 d
Metals, Total	no req.	P, G	none	180 d
Mercury, Total	no req.	P, G	none	28 d
Moisture	≤6°C	P, G	none	14 d
pH	no req.	P, G	none	365 d
Sulfide	≤6°C	P, G	store field moist	7 d
TCLP - Mercury	no req.	P, G	none	28 / 28 d
TCLP – Metals	no req.	P, G	none	180/180d
ORGANICS				
Carbon (TC, TOC)	≤6°C	P, G	none	28 d
	no req.	P, G	dried stage	unlimited
Chlorinated and Non-chlorinated phenolics	≤6°C	G	none	14 / 40
Dioxins / Furans	≤6°C	G	none	unlimited
Extractable Hydrocarbons (LEPH, HEPH, EPH)	≤6°C	G	none	14 / 40
Glycols	≤6°C	G	none	14 / 40
Herbicides, Acid Extractable	≤6°C	G	none	14 / 40
Oil and Grease / Mineral Oil and Grease / Waste Oil Content	≤6°C	G	none	28 d
Pesticides (NP, OP, OC)	≤6°C	G	none	14 / 40
Polychlorinated Biphenyls (PCBs)	≤6°C	G	none	unlimited
Polycyclic Aromatic Hydrocarbons (PAHs)	≤6°C	G	none	14 / 40

Biological Sample Collection: Freshwaters

Resin Acids, Fatty Acids	≤6°C	G	none	14 / 40
TCLP - Volatile Organic Compounds	≤6°C	G	none	14 / 14
TCLP - Semi-Volatile Organic Compounds	≤6°C	G	none	14 / 40
Volatile Organic Compounds (VOC, BTEX, VH, THM)	≤6°C	G	none	7 ⁽⁶⁾ / 40

BIOTA

INORGANICS

Metals, Total	freeze (≤ -18°C)	P, G	none	2 years
Mercury, Total	freeze (≤ -18°C)	P, G	none	1 years

ORGANICS

Semi-Volatile Organic Compounds	freeze (≤ -18°C)	G, PTFE	none	365 / 40
Volatile Organic Compounds	freeze (≤ -18°C)	G, PTFE	none	14 d

LEGEND

P = plastic	G = glass	Tf = Teflon™
B = Baked	T = Tissue Cup	no req = no requirement
Solv = solvent cleaned	A = amber	
Fc = foil lined cap	W = wide mouth	

***NOTE: glass or Teflon™ containers must be used if mercury is to be analyzed.**

³ Storage temperature applies to storage at the laboratory. For all tests where refrigeration at ≤6°C is required at the laboratory, samples should be packed with ice or cold packs to maintain a temperature of ≤10°C during transport to the laboratory. The storage of ≤8°C for microbiological samples applies during storage at the laboratory and during transport to the laboratory. To prevent breakage, water samples stored in glass should not be frozen. Except where indicated by "do not freeze", test results need not be qualified for frozen samples.

⁴ Hold Times: Single values refer to hold time from sampling to analysis. Where 2 values are given, the first is hold time from sampling to extraction, and the second is hold time from extraction to analysis.

⁶ Methanol extraction or freezing must be initiated within 48 hours of arrival at lab, to a maximum of 7 days from sample collection. Alternatively, samples may be frozen in the field if extracted within 14 days of sampling, or may be methanol extracted in the field.

Appendix 3 Laboratory Sample Container, Preservation, and Hold Times for Fresh Water Biological Sampling

TYPE OF ANALYSIS	STORAGE TEMP⁽³⁾	CONTAINER TYPE	PRESERVATION	MAXIMUM HOLD TIME⁽⁴⁾
MICROBIOLOGICAL PARAMETERS				
Coliforms, Total, Fecal and <i>E. coli</i>	<8°C, do not freeze	Ster P or G	Na ₂ S ₂ O ₃	30 hours ⁽⁵⁾
<i>Cryptosporidium</i> , <i>Giardia</i>	<8°C, do not freeze	Ster P or G	Na ₂ S ₂ O ₃	96 hours
<i>Enterococcus</i>	<8°C, do not freeze	Ster P or G	Na ₂ S ₂ O ₃	30 hours ⁽⁵⁾
Heteroprophic Plate Count	<8°C, do not freeze	Ster P or G	Na ₂ S ₂ O ₃	24 hours
TOXICITY				
Daphnia, Chronic 21 day/ Chronic EC25	4±2°C	P, G (non-toxic)	collect with no headspace	5 d
Daphnia, LC50 / LT50	4±2°C	P, G (non-toxic)	collect with no headspace	5 d
Microtox	4±2°C	P, G (non-toxic)	collect with no headspace	3 d
Trout, LC50	4±2°C	P, G (non-toxic)	collect with no headspace	5 d
Trout, LT50	4±2°C	P, G (non-toxic)	collect with no headspace	5 d

LEGEND

P = plastic

Ster = sterile

W = wide mouth

³ Storage temperature applies to storage at the laboratory. For all tests where refrigeration at ≤6°C is required at the laboratory, samples should be packed with ice or cold packs to maintain a temperature of ≤10°C during transport to the laboratory. The storage of ≤8°C for microbiological samples applies during storage at the laboratory and during transport to the laboratory. To prevent breakage, water samples stored in glass should not be frozen. Except where indicated by "do not freeze", test results need not be qualified for frozen samples.

Biological Sample Collection: Freshwaters

⁴ Hold Times: Single values refer to hold time from sampling to analysis. Where 2 values are given, the first is hold time from sampling to extraction, and the second is hold time from extraction to analysis.

⁵ Samples received from remote locations more than 48 hours after collection must not be tested.